

dji MINI 3

User Manual

v1.0 2022.11

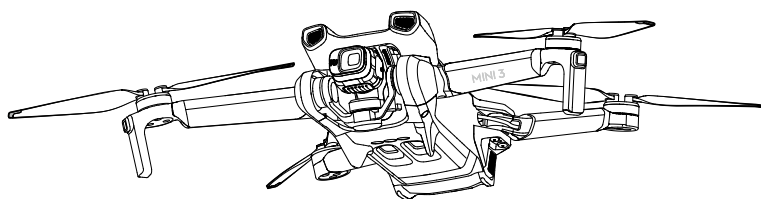

Searching for Keywords

Search for keywords such as “battery” and “install” to find a topic. If you are using Adobe Acrobat Reader to read this document, press Ctrl+F on Windows or Command+F on Mac to begin a search.



Navigating to a Topic

View a complete list of topics in the table of contents. Click on a topic to navigate to that section.



Printing this Document

This document supports high resolution printing.

Using this manual

Legend

 Important

 Hints and Tips

 Reference

Read Before the First Flight

Read the following documents before using the DJI™ Mini 3:

1. Safety Guidelines
2. Quick Start Guide
3. User Manual

It is recommended to watch all tutorial videos on the official DJI website and read safety guidelines before using for the first time. Prepare for your first flight by reviewing the quick start guide and refer to this user manual for more information.

Video Tutorials

Go to the address below or scan the QR code to watch the DJI Mini 3 tutorial videos, which demonstrate how to use DJI Mini 3 safely:



<https://s.dji.com/guide43>

Download the DJI Fly App

Make sure to use DJI Fly during flight. Scan the QR code above to download the latest version.

-  • The DJI RC remote controller has the DJI Fly app already installed. Users are required to download DJI Fly to their mobile device when using DJI RC-N1 remote controller.
- The Android version of DJI Fly is compatible with Android v6.0 and later. The iOS version of DJI Fly is compatible with iOS v11.0 and later.

* For increased safety, flight is restricted to a height of 98.4 ft (30 m) and range of 164 ft (50 m) when not connected or logged into the app during flight. This applies to DJI Fly and all apps compatible with DJI aircraft.

Download DJI Assistant 2 (Consumer Drones Series)

Download DJI ASSISTANT™ 2 (Consumer Drones Series) at <https://www.dji.com/mini-3/downloads>

-  • The operating temperature of this product is -10° to 40° C. It does not meet the standard operating temperature for military grade application (-55° to 125° C), which is required to endure greater environmental variability. Operate the product appropriately and only for applications that it meets the operating temperature range requirements of that grade.

目录

Using this manual	1
Legend	1
Read Before the First Flight	1
Video Tutorials	1
Download the DJI Fly App	1
Download DJI Assistant 2 (Consumer Drones Series)	1
Product Profile	5
Introduction	5
Using for the First Time	5
Diagram	8
Aircraft	12
Flight Modes	12
Aircraft Status Indicator	13
QuickTransfer	14
Return to Home	15
Vision System and Infrared Sensing System	17
Intelligent Flight Mode	19
Flight Recorder	20
Propellers	20
Intelligent Flight Battery	22
Gimbal and Camera	29
Remote Controller	32
DJI RC	32
DJI RC-N1	40
DJI Fly App	46
Home	46
Camera View	47

Flight	52
Flight Environment Requirements	52
Flight Limits	52
Pre-Flight Checklist	54
Auto Takeoff/Landing	54
Starting/Stopping the Motors	55
Flight Test	56
Appendix	57
Specifications	57
Firmware Update	64
Aftersales Information	65

Product Profile

This section introduces DJI Mini 3 and lists the components of the aircraft and remote controller.

Product Profile

Introduction

DJI Mini 3 boasts a foldable design and an ultralight weight of less than 249 g. Featuring a Downward Vision System and an Infrared Sensing System, DJI Mini 3 can hover and fly indoors as well as outdoors and automatically initiate Return to Home (RTH). The aircraft has a maximum flight time of 38 minutes when using an Intelligent Flight Battery, and a maximum flight time of 51 minutes when using an Intelligent Flight Battery Plus.

DJI Mini 3 can work with the DJI RC remote controller and the DJI RC-N1 remote controller. Refer to the Remote Controller section for more details.

Feature Highlights

Gimbal and Camera: With a fully stabilized 3-axis gimbal and a 1/1.3-in sensor camera, DJI Mini 3 is able to shoot 4K video and 12MP photos. It also supports switching between Landscape mode and Portrait mode with one tap in DJI Fly.

Video Transmission: With DJI's long-range transmission OCUSYNC™ 2.0 technology DJI Mini 3 offers a maximum transmission range of 10 km and video quality at up to 720p 30fps from the aircraft to DJI Fly. The remote controller works at both 2.4 and 5.8 GHz, and is capable of selecting the best transmission channel automatically.

Intelligent Flight Modes: Enjoy intelligent flight modes such as QuickShots and Panorama, while QuickTransfer makes downloading photos and videos more convenient and efficient.



- The maximum flight time was tested in a windless environment at near sea level while flying at a consistent speed of 13 mph (21.6 kph).
- The remote controller reaches its maximum transmission distance (in FCC compliant mode) in a wide open area with no electromagnetic interference, at an altitude of about 120 m (400 ft).
- The 5.8 GHz frequency is not supported in some regions, where it will automatically be disabled. Always observe local laws and regulations.
- The Intelligent Flight Battery Plus is available in just some countries and regions. Visit the official DJI online store for more information.
- The maximum takeoff weight will be more than 249 g if the aircraft is used with the Intelligent Flight Battery Plus. Make sure to observe local laws and regulations about the takeoff weight.

Using for the First Time

Preparing the Aircraft

All aircraft arms are folded before the aircraft is packaged. Follow the steps below to unfold the aircraft.

1. Remove the gimbal protector from the camera.

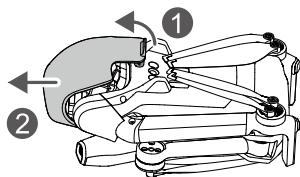

- All Intelligent Flight Batteries are in hibernation mode before shipment to ensure safety. Connect a USB charger to the USB-C port on the aircraft to charge and activate the Intelligent Flight Battery for the first time.

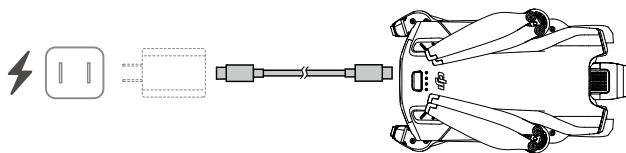

- Unfold the rear arms, followed by the front arms, and then all of the propeller blades.

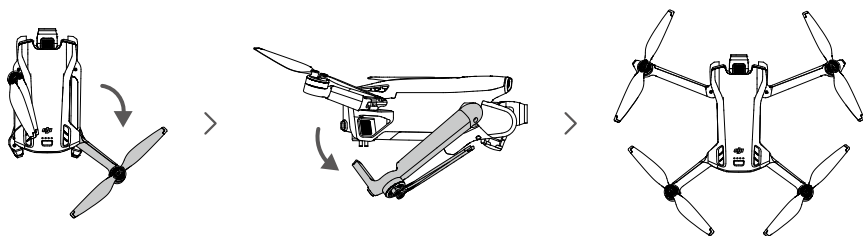

-  It is recommended to use the DJI 30W USB-C Charger or other USB Power Delivery chargers.
- The maximum charge voltage for the aircraft charging port is 15 V.
 - Make sure the gimbal protector is removed and all arms are unfolded before powering on the aircraft. Otherwise, it may affect the aircraft self-diagnostics.
 - Attach the gimbal protector when the aircraft is not in use. Ensure all arms are folded before reattaching the gimbal protector. First rotate the camera to make it horizontal and forward-facing ①, then insert the latch on the upper part of the protector onto the opening on the aircraft ②, and insert the two locating pins into the holes at the bottom of the aircraft ③.



Preparing the Remote Controller

Follow the steps below to prepare the DJI RC remote controller.

1. Remove the control sticks from the storage slots and mount them on the remote controller.

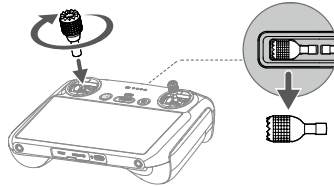

2. The remote controller needs to be activated before first use and an internet connection is required for activation. Press, and then press again and hold the power button to power on the remote controller. Follow the on-screen prompts to activate the remote controller.

Follow the steps below to prepare the DJI RC-N1 remote controller.

1. Remove the control sticks from the storage slots and mount them on the remote controller.
2. Pull out the mobile device holder. Choose the appropriate remote controller cable based on the port type of your mobile device (a Lightning connector cable, Micro USB cable, and USB-C cable are included in the packaging). Place your mobile device in the holder, then connect the end of the cable without the remote controller logo to your mobile device. Make sure your mobile device is securely in place.

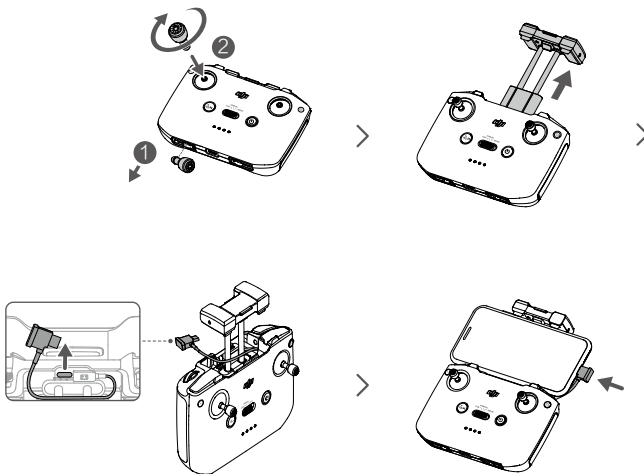

• If a USB connection prompt appears when an Android mobile device is used, select the option to charge only. Other options may cause the connection to fail.

Activating the DJI Mini 3 Aircraft

DJI Mini 3 requires activation before first use. After powering on the aircraft and remote controller, follow the on-screen prompts to activate DJI Mini 3 using DJI Fly. An internet connection is required for activation.

Binding the Aircraft and Remote Controller

After activation, the aircraft is bound to the remote controller automatically. If automatic binding fails, follow the on-screen prompts on DJI Fly to bind the aircraft and remote controller for optimal warranty services.

Updating Firmware

A prompt will appear in DJI Fly when new firmware is available. Update the firmware whenever prompted to ensure optimal user experience.

Diagram

Aircraft

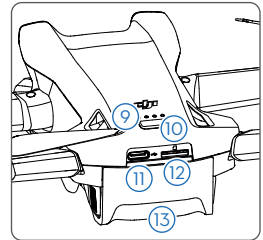
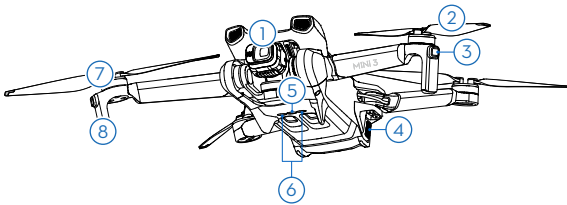

- | | |
|----------------------------|--------------------------------------|
| 1. Gimbal and Camera | 8. Landing Gears (Built-in antennas) |
| 2. Propellers | 9. Battery Level LEDs |
| 3. Aircraft Status LEDs | 10. Power Button |
| 4. Battery Buckles | 11. USB-C Port |
| 5. Downward Vision System | 12. microSD Card Slot |
| 6. Infrared Sensing System | 13. Intelligent Flight Battery |
| 7. Motors | |

DJI RC Remote Controller

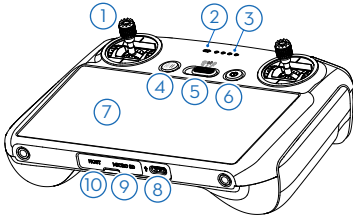

1. Control Sticks

Use the control sticks to control the movement of the aircraft. The control sticks are removable and easy to store. Set the flight control mode in DJI Fly.

2. Status LED

Indicates the status of the remote controller.

3. Battery Level LEDs

Displays the current battery level of the remote controller.

4. Flight Pause/Return to Home (RTH) Button

Press once to make the aircraft brake and hover in place (only when GNSS or Vision

System is available). Press and hold to initiate RTH. Press again to cancel RTH.

5. Flight Mode Switch

Switch between Cine, Normal, and Sport mode.

6. Power Button

Press once to check the current battery level. Press, and then press and hold to power the remote controller on or off. When the remote controller is powered on, press once to turn the touchscreen on or off.

7. Touchscreen

Touch the screen to operate the remote controller. Note that the touchscreen is not waterproof. Operate with caution.

8. USB-C Port

For charging and connecting the remote controller to your computer.

9. microSD Card Slot

For inserting a microSD card.

10. USB-C Connector

For connecting a USB-C headphone.

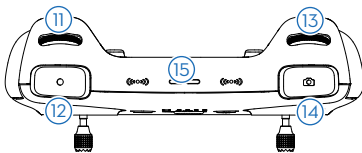

11. Gimbal Dial

Controls the tilt of the camera.

12. Record Button

Press once to start or stop recording.

13. Camera Control Dial

For zoom control.

14. Focus/Shutter Button

Press halfway down on the button to auto focus and press all the way down to take a photo.

15. Speaker

Outputs sound.

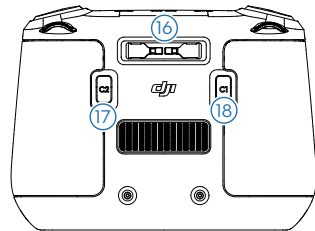

16. Control Sticks Storage Slot

For storing the control sticks.

17. Customizable C2 Button

Switch between landscape mode and portrait mode. The function can be set in DJI Fly.

18. Customizable C1 Button

Switch between recentering the gimbal and pointing the gimbal downward. The function can be set in DJI Fly.

DJI RC-N1 Remote Controller

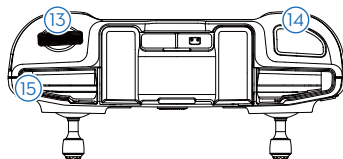
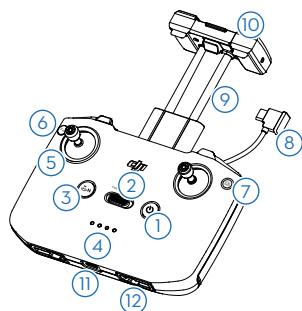

1. Power Button

Press once to check the current battery level. Press, and then press and hold to power the remote controller on or off.

2. Flight Mode Switch

Switch between Sport, Normal, and Cine mode.

3. Flight Pause/Return to Home (RTH) Button

Press once to make the aircraft brake and hover in place (only when GNSS or Vision System is available). Press and hold to initiate RTH. Press again to cancel RTH.

4. Battery Level LEDs

Displays the current battery level of the remote controller.

5. Control Sticks

The control sticks are removable and easy to store. Set the flight control mode in DJI Fly.

6. Customizable Button

The functions of the button can be set in DJI Fly. Press once to recenter the gimbal or point the gimbal downward (default settings).

7. Photo/Video Toggle

Press once to switch between photo and video mode.

8. Remote Controller Cable

Connect to a mobile device for video linking via the remote controller cable. Select the cable according to the port type on your mobile device.

9. Mobile Device Holder

For mounting the mobile device securely on the remote controller.

10. Antennas

Transmit aircraft control and wireless video signals.

11. USB-C Port

For charging and connecting the remote controller to your computer.

12. Control Sticks Storage Slot

For storing the control sticks.

13. Gimbal Dial

Controls the tilt of the camera. Press and hold the customizable button to use the gimbal dial for zoom control.

14. Shutter/Record Button

Press once to take photos or start or stop recording.

15. Mobile Device Slot

For securing the mobile device.

Aircraft

DJI Mini 3 contains a flight controller, video downlink system, vision systems, infrared sensing system, propulsion system, and an Intelligent Flight Battery.

Aircraft

DJI Mini 3 contains a flight controller, video downlink system, downward vision system, infrared sensing system, propulsion system, and an Intelligent Flight Battery.

Flight Modes

DJI Mini 3 has three flight modes, plus a fourth flight mode that the aircraft switches to in certain scenarios. Flight modes can be switched via the Flight Mode switch on the remote controller.

Normal Mode: The aircraft utilizes GNSS and the Downward Vision System and Infrared Sensing System to locate itself and stabilize. When the GNSS signal is strong, the aircraft uses GNSS to locate itself and stabilize. When the GNSS is weak but the lighting and other environmental conditions are sufficient, it uses the Downward Vision System. When the lighting and other environmental conditions are sufficient, the maximum tilt angle is 25° and the maximum flight speed is 10 m/s.

Sport Mode: In Sport mode, the aircraft uses GNSS and the Downward Vision System for positioning. In Sport mode, aircraft responses are optimized for agility and speed making it more responsive to control stick movements. The maximum flight speed reaches 16 m/s.

Cine Mode: Cine mode is based on Normal mode and the flight speed is limited, making the aircraft more stable during shooting. The maximum flight speed is 6 m/s.

The aircraft automatically changes to Attitude (ATTI) mode when the Downward Vision System is unavailable or disabled and when the GNSS signal is weak or the compass experiences interference. In ATTI mode, the aircraft may be more easily affected by its surroundings. Environmental factors such as wind can result in horizontal shifting. The Intelligent flight modes or the Return to Home function cannot be used. The aircraft cannot position itself or brake automatically, which increases the risk of potential flight hazards. To avoid changing to ATTI mode, users should avoid flying in environments with poor GNSS signal or poor lighting condition, and do not fly in confined spaces.



- The maximum speed and braking distance of the aircraft significantly increase in Sport mode. A minimum braking distance of 30 m is required in windless conditions
 - A minimum braking distance of 10 m is required in windless conditions while the aircraft is ascending and descending in Sport mode or Normal mode.
 - The responsiveness of the aircraft significantly increases in Sport mode, which means a small control stick movement on the remote controller translates into the aircraft moving a large distance. Make sure to maintain adequate maneuvering space during flight.
 - The flight speed and attitude are both restricted when the aircraft is flying leftward or rightward to ensure shooting stability. The restriction reaches its maximum when the tilt of the gimbal is -90°. If there are strong winds, the restriction will be disabled to improve the wind resistance of the aircraft. As a result, the gimbal may vibrate while shooting.
 - Users may experience a minor tremor in videos recorded in Sport mode.
-





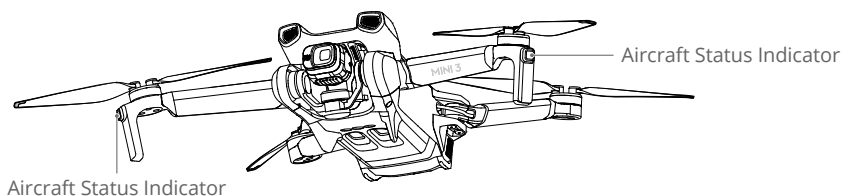











Aircraft Status Indicator

DJI Mini 3 has two aircraft status indicators.



Refer to the table below for more information about the aircraft status indicators.

Aircraft Status Indicator Descriptions

Normal States		
	Blinks purple slowly	Warming up
	Alternating red, green and yellow	Powering on and performing self-diagnostic tests
	Blinks green slowly	GNSS enabled
 x2	Periodically blinks green twice	Downward Vision System enabled
	Blinks yellow slowly	GNSS and Downward Vision System disabled (ATTI mode enabled)
	Blinks blue slowly	Switching between Wi-Fi connection and OcuSync 2.0 video transmission connection
 x2	Periodically blinks blue twice	Switched to Wi-Fi connection and waiting to connect to mobile device
 —	Solid blue	Switched to Wi-Fi connection and connected to mobile device
	Blinks blue quickly	Switched to Wi-Fi connection and downloading at high speed
 —	Solid red	Failed to switch to Wi-Fi connection
	Blinks red slowly	ESC is beeping while using Find My Drone
Warning States		
	Blinks yellow quickly	Remote controller signal lost
	Blinks red slowly	Low battery
	Blinks red quickly	Critically low battery
	Periodically blinks red	IMU error
 —	Solid red	Critical error
	Blinks red and yellow alternately	Compass calibration required

QuickTransfer

DJI Mini 3 can connect directly to mobile devices via Wi-Fi, enabling users to download photos and videos from the aircraft to the mobile device through DJI Fly without using the DJI RC-N1 remote controller.

Users can enjoy faster and more convenient downloads with a transmission rate of up to 25 MB/s.

Usage

Method 1: mobile device is not connected to the DJI RC-N1 remote controller.

1. Power on the aircraft and wait until the self-diagnostic tests of the aircraft are complete. Quickly press the power button three times to switch to QuickTransfer mode. The aircraft status LEDs will blink blue once switching is successful.
2. Make sure Bluetooth and Wi-Fi are enabled on the mobile device. Launch DJI Fly and a prompt will appear to connect to the aircraft.
3. Tap Connect. Once successfully connected, the files on the aircraft can be accessed and downloaded at high speed. Note that when connecting the mobile device to the aircraft for the first time, you need to press and hold the power button for two seconds to confirm.

Method 2: mobile device is connected to the DJI RC-N1 remote controller



1. Make sure that the aircraft is connected to the mobile device via the DJI RC-N1 remote controller and the motors have not started.
2. Enable Bluetooth and Wi-Fi on the mobile device.
3. Launch DJI Fly, enter playback, and tap  in the upper right corner. Switch to QuickTransfer mode by following the prompts in DJI Fly. Download the files on the aircraft at high speed once switching is complete.





- The maximum download rate can only be achieved in countries and regions where the 5.8 GHz frequency is permitted by laws and regulations, when using devices that support 5.8 GHz frequency band and Wi-Fi connection, and in an environment without interference or obstruction. If 5.8 GHz is not allowed by local regulations (such as in Japan), or the mobile device of the user does not support the 5.8 GHz frequency band, or the environment has severe interference, then QuickTransfer will use the 2.4 GHz frequency band and its maximum download rate will reduce to 6 MB/s.
 - Make sure that Bluetooth, Wi-Fi, and location services are enabled on the mobile device before using QuickTransfer.
 - When using QuickTransfer, it is not necessary to enter the Wi-Fi password on the settings page of the mobile device in order to connect. Launch DJI Fly and a prompt will appear to connect the aircraft.
 - Use QuickTransfer in an unobstructed environment with no interference and stay away from sources of interference such as wireless routers, Bluetooth speakers, or headphones.
-

Return to Home

The Return to Home (RTH) function brings the aircraft back to the last recorded Home Point when the positioning system is functioning normally. There are three RTH modes: Smart RTH, Low Battery RTH, and Failsafe RTH. The aircraft will automatically fly back and land at the Home Point when Smart RTH is initiated, the aircraft enters Low Battery RTH, or the signal between the remote controller and the aircraft is lost. RTH will also be triggered in other abnormal scenarios such as where video transmission is lost.

	GNSS	Description
Home Point	 10	The first location where the aircraft receives a strong to moderately strong GNSS signal (indicated by a white icon) will be recorded as the default Home Point. It is recommended to wait until the Home Point is successfully recorded before flying. After the Home Point is recorded, a prompt will appear in DJI Fly. The Home Point can be updated before takeoff as long as the aircraft receives another strong to moderately strong GNSS signal. If the signal is weak, the Home Point will not be updated. If it is necessary to update the Home Point during a flight (such as where the user's position has changed), the Home Point can be manually updated in Safety of System Settings on DJI Fly.

Smart RTH

If the GNSS signal is sufficient, Smart RTH can be used to bring the aircraft back to the Home Point. Smart RTH is initiated either by tapping  in DJI Fly or by pressing and holding the RTH button on the remote controller. Exit Smart RTH by tapping  in DJI Fly or by pressing the RTH button on the remote controller.

Low Battery RTH

When the Intelligent Flight Battery level is too low and there is not enough power to return home, land the aircraft as soon as possible. Otherwise, the aircraft will fall when it runs out of power, resulting in the aircraft being damaged and other potential hazards.

To avoid unnecessary danger due to insufficient power, DJI Mini 3 will intelligently determine whether the current battery level is sufficient to return home based on the current location. A warning prompt will appear in DJI Fly when the battery level is low and only enough to complete an RTH flight.

The user can cancel RTH by pressing the RTH button on the remote controller. If RTH is cancelled following a low battery warning, the Intelligent Flight Battery may not have enough power for the aircraft to land safely. As a result, you may crash or lose your aircraft.

The aircraft will automatically land if the battery level is extremely low. Auto landing cannot be canceled but the remote controller can be used to alter the horizontal movement and the speed of descent of the aircraft during landing.

The aircraft will land automatically if the battery level will only last long enough to directly descend and land from its current altitude. The action cannot be canceled but the remote controller can be used to alter the horizontal movement of the aircraft.

Failsafe RTH

The action the aircraft performs once it loses the remote controller signal can be set as Return to Home, Land, or Hover in DJI Fly. If the action was set as Land or Hover, Failsafe RTH will not be activated. If the action was set as Return to Home in advance, and where the Home Point has been recorded, the GNSS signal is good, and the compass is functioning normally, Failsafe RTH will automatically activate once the remote controller signal is lost for more than 11 seconds.

The aircraft will fly backwards for 50 m on its original flight route and ascend to the preset RTH altitude to enter Straight Line RTH. The aircraft enters Straight Line RTH if the remote controller signal is restored during Failsafe RTH. When the aircraft flies backwards along the original flight path and the distance from the Home Point is less than 20 m, the aircraft stops flying backward on the original flight route and enters Straight Line RTH at the current altitude.

Other RTH Scenarios

There will be a prompt to initiate RTH if the video link signal is lost during flight while the remote controller is still able to control the movements of the aircraft. RTH can be cancelled.

RTH Procedure (Straight Line)

1. The Home Point is recorded.
2. RTH is triggered.
3. If the aircraft is less than 20 m from the Home Point when RTH begins, it will hover in place and not return to home. If the aircraft is further than 20 m from the Home Point when RTH begins, it will return home at a horizontal speed of 10.5 m/s.
4. After reaching the Home Point, the aircraft lands and the motors stop.



- The aircraft cannot return to the Home Point if the GNSS signal is weak or unavailable. The aircraft may enter ATTI mode if the GNSS signal becomes weak or unavailable after entering Failsafe RTH. The aircraft will hover in place for a while before landing.
 - It is important to set a suitable RTH altitude before each flight. Launch DJI Fly and set the RTH altitude. In RTH, if the current altitude of the aircraft is lower than the RTH altitude, it will automatically ascend to the RTH altitude first. If the current altitude of the aircraft reaches or is higher than the RTH altitude, it will fly to the Home Point at its current altitude.
 - During RTH, the speed and altitude of the aircraft can be controlled using the remote controller if the remote controller signal is normal. However, the aircraft cannot be shifted leftward or rightward. When the aircraft is ascending or flying forward, push the control stick completely in the opposite direction to exit RTH, and the aircraft will brake and hover.
 - GEO zones may affect the RTH. Avoid flying near GEO zones.
 - The aircraft may not be able to return to the Home Point when the wind speed is too high. Fly with caution.
-

Landing Protection

Landing Protection will activate during Smart RTH.

1. During Landing Protection, the aircraft will automatically detect and carefully land on suitable ground.
2. If the ground is determined unsuitable for landing, DJI Mini 3 will hover and wait for pilot confirmation.
3. If Landing Protection is not operational, DJI Fly will display a landing prompt when the aircraft descends to 0.5 m from the ground. Tap confirm or pull down on the throttle stick to land.

Vision System and Infrared Sensing System

DJI Mini 3 is equipped with a Downward Vision System and Infrared Sensing System. The Downward Vision System consists of one camera and the Infrared Sensing System consists of two 3D infrared modules. The Downward Vision System and Infrared Sensing System help the aircraft maintain its current position, hover in place more precisely, and to fly indoors or in other environments where GNSS is unavailable.

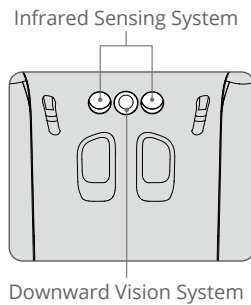

Detection Range

The Downward Vision System works best when the aircraft is at an altitude of 0.5 m to 10 m and its operating range is 0.5 m to 30 m. FOV is 56° (left and right) and 71° (front and back).

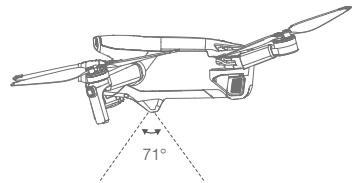
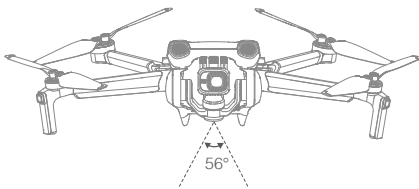

Using the Vision Systems

When GNSS is unavailable, the Downward Vision System is enabled if the surface has a clear texture and there is sufficient light. The Downward Vision System works best when the aircraft is at an altitude of 0.5 to 10 m. If the altitude of the aircraft is above 10 m, the Vision System may be affected. Extra caution is required.







- Pay attention to the flight environment. The Downward Vision System and Infrared Sensing System only work under limited conditions and cannot replace human control and judgment. During flight, always pay attention to the surrounding environment and to the warnings on DJI Fly and be responsible for and maintain control of the aircraft.
 - The aircraft has a max hovering altitude of 5 m if GNSS is unavailable.
 - The Downward Vision System may not function properly when the aircraft is flying over water. Therefore, the aircraft may not be able to actively avoid water below when landing. It is recommended to maintain flight control at all times, make reasonable judgments based on the surrounding environment, and avoid relying on the Downward Vision System.
 - Note that the Downward Vision System and Infrared Sensing System may not function properly when the aircraft is flying too fast. The Infrared Sensing System only takes effect when the flight speed is no more than 12 m/s.
 - The Downward Vision System cannot work properly over surfaces that do not have clear pattern variations or there is weak light. The Downward Vision System cannot work properly in any of the following situations. Operate the aircraft cautiously.
 - a) Flying over monochrome surfaces (e.g., pure black, pure white, pure green).
 - b) Flying over highly reflective surfaces.
 - c) Flying over water or transparent surfaces.
 - d) Flying over moving surfaces or objects.
 - e) Flying in an area where the lighting changes frequently or drastically.
 - f) Flying over extremely dark (< 10 lux) or bright (> 40,000 lux) surfaces.
 - g) Flying over surfaces that strongly reflect or absorb infrared waves (e.g., mirrors).
 - h) Flying over surfaces without clear patterns or texture. (e.g., power pole).
 - i) Flying over surfaces with repeating identical patterns or textures (e.g., tiles with the same design).
 - j) Flying over obstacles with small surface areas (e.g., tree branches).
 - Keep the sensors clean at all times. DO NOT tamper with the sensors. DO NOT use the aircraft in environment with dust and humidity. DO NOT obstruct the Infrared Sensing System.
 - DO NOT fly when it is rainy, smoggy, or if there is no clear sight.
 - Check the following every time before takeoff:
 - a) Make sure there are no stickers or any other obstructions over the Infrared Sensing System or Downward Vision System.
 - b) If there is any dirt, dust, or water on the Infrared Sensing System or Downward Vision System, clean with a soft cloth. DO NOT use any cleanser that contains alcohol.
 - c) Contact DJI Support if there is any damage to the glass of the Infrared Sensing System or Downward Vision System.
-

Intelligent Flight Mode

QuickShots

QuickShots shooting modes include Dronie, Rocket, Circle, Helix, and Boomerang. DJI Mini 3 records according to the selected shooting mode and automatically generates a short video. The video can be viewed, edited, or shared to social media from playback.

-  **Dronie:** The aircraft flies backward and ascends with the camera locked on the subject.
-  **Rocket:** The aircraft ascends with the camera pointing downward.
-  **Circle:** The aircraft circles around the subject.
-  **Helix:** The aircraft ascends and spirals around the subject.
-  **Boomerang:** The aircraft flies around the subject in an oval path, ascending as it flies away from its starting point and descending as it flies back. The starting point of the aircraft forms one end of the long axis of the oval, while the other end of its long axis is at the opposite side of the subject from the starting point. Make sure there is sufficient space when using Boomerang. Allow a radius of at least 99 ft (30 m) around the aircraft and allow at least 33 ft (10 m) above the aircraft.

Using QuickShots

1. Make sure that the Intelligent Flight Battery is sufficiently charged. Take off and hover at least 6.6 ft (2 m) above the ground.

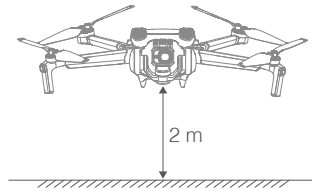

2. In DJI Fly, tap the shooting mode icon to select QuickShots and follow the prompts. Make sure that you understand how to use the shooting mode and that there are no obstacles in the surrounding area.

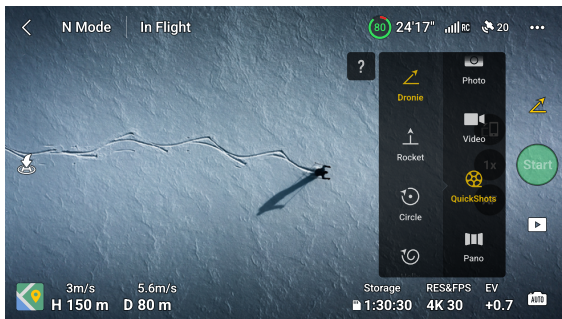

3. Choose a shooting mode, select your target subject in the camera view by tapping the circle on the subject or dragging a box around the subject, and tap Start to begin recording (It is recommended to choose a human as a target subject rather than a building). The aircraft will fly back to its original position once shooting is finished.
4. Tap  to access the short video or the original video. You can edit the video or share to social media after downloading.

Exiting QuickShots

Press the Flight Pause/RTH button once or tap  in DJI Fly to exit QuickShots. The aircraft will hover in place.

If you accidentally move a control stick, the aircraft will exit QuickShots and hover in place as well.





- Use QuickShots at locations that are clear of buildings and other obstacles. Make sure that there are no humans, animals, or other obstacles on the flight path.
- Pay attention to objects around the aircraft and use the remote controller to avoid collisions with the aircraft.
- DO NOT use QuickShots in any of the following situations:
 - a) When the subject is blocked for an extended period or outside the line of sight.
 - b) When the subject is more than 50 m away from the aircraft.
 - c) When the subject is similar in color or pattern with the surroundings.
 - d) When the subject is in the air.
 - e) When the subject is moving fast.
 - f) When the lighting is extremely low (<300 lux) or high (>10,000 lux).
- DO NOT use QuickShots in places that are close to buildings or where the GNSS signal is weak. Otherwise, the flight path will be unstable.
- Make sure to follow local privacy laws and regulations when using QuickShots.

Flight Recorder

Flight data including flight telemetry, aircraft status information, and other parameters are automatically saved to the internal data recorder of the aircraft. The data can be accessed using DJI Assistant 2 (Consumer Drones Series).

Propellers

There are two types of propellers, which are designed to spin in different directions. Marks are used to indicate which propellers should be attached to which motors. The two blades attached to one motor are the same.

Propellers	Marked	Unmarked
Illustration		
Mounting Position	Attach to the motors of the marked arm	Attach to the motors of the unmarked arm

Attaching the Propellers

Attach the propellers with marks to the motors of the arm with marks and the unmarked propellers to the motors of the arm without marks. Use the screwdriver from the aircraft package to mount the propellers. Make sure the propellers are secure.

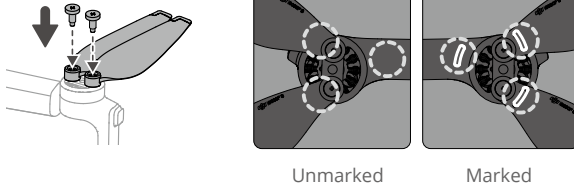

-
- ⚠ • Make sure to only use the screwdriver from the aircraft package for mounting propellers. Using other screwdrivers may damage the screws.
 - Make sure to keep the screws vertical while tightening them. The screws should not be at a tilted angle to the mounting surface. After installation is complete, check whether the screws are flush and rotate the propellers to check for any abnormal resistance.
-

Detaching the Propellers

Use the screwdriver from the aircraft package to loosen the screws and detach the propellers from the motors.

-
- ⚠ • Propeller blades are sharp. Handle with care.
 - The screwdriver is only for mounting the propellers. DO NOT use the screwdriver to disassemble the aircraft.
 - If a propeller is broken, remove the two propellers and screws on the corresponding motor and discard them. Use two propellers from the same package. DO NOT mix with propellers from other packages.
 - Only use official DJI propellers. DO NOT mix propeller types.
 - Purchase additional propellers if necessary.
 - Make sure that the propellers and motors are installed securely before each flight. Check to make sure the screws on the propellers are tightened after every 30 hours of flying time (approx. 60 flights).
 - Make sure all propellers are in good condition before each flight. DO NOT use aged, chipped, or broken propellers.
 - To avoid injury, stand clear of and do not touch propellers or motors when they are spinning.
 - DO NOT squeeze or bend the propellers during transportation or storage.
 - Make sure the motors are mounted securely and rotating smoothly. Land the aircraft immediately if a motor is stuck and unable to rotate freely.
 - DO NOT attempt to modify the structure of the motors.
 - DO NOT touch or let hands or body parts come in contact with the motors after flight as they may be hot.
 - DO NOT block any of the ventilation holes on the motors or the body of the aircraft.
 - Make sure the ESCs sound normal when powered on.
-

Intelligent Flight Battery

The DJI Mini 3 aircraft is compatible with both the DJI Mini 3 Pro Intelligent Flight Battery (BWX162-2453-7.38) and the DJI Mini 3 Pro Intelligent Flight Battery Plus (BWX162-3850-7.38).

DJI Mini 3 Pro Intelligent Flight Battery is a 7.38 V, 2453 mAh battery. DJI Mini 3 Pro Intelligent Flight Battery Plus is a 7.38 V, 3850 mAh battery. The two batteries have the same structure and dimensions but different weight and capacity. Both batteries are equipped with smart charging and discharging functionality.

Battery Features

1. **Balanced Charging:** During charging, the voltages of the battery cells are automatically balanced.
2. **Auto-Discharging Function:** To prevent swelling, the battery automatically discharges to approximately 96% of the battery level when it is idle for one day, and approximately 60% when idle for nine days. It is normal to feel moderate heat from the battery while it is discharging.
3. **Overcharge Protection:** The battery stops charging automatically once fully charged.
4. **Temperature Detection:** To prevent damage, the battery only charges at temperatures from 5° to 40° C (41° to 104° F). Charging stops automatically if the temperature of the battery cells exceed 55° C (131° F) during charging.
5. **Overcurrent Protection:** The battery stops charging if an excess current is detected.
6. **Over-Discharge Protection:** Discharging stops automatically to prevent excess discharge when the battery is not in use. Over-discharge protection is not enabled when the battery is in use.
7. **Short Circuit Protection:** The power supply is automatically cut if a short circuit is detected.
8. **Battery Cell Damage Protection:** DJI Fly displays a warning prompt when a damaged battery cell is detected.
9. **Hibernation Mode:** If the battery cell voltage is lower than 3.0 V or the battery level is less than 10%, the battery enters Hibernation mode to prevent over-discharge. Charge the battery to wake it from hibernation.
10. **Communication:** Information about the voltage, capacity, and current of the battery is transmitted to the aircraft.



- Refer to the DJI Mini 3 Safety Guidelines and the stickers on the battery before use. Users take full responsibility for any violations of the safety requirements stated on the label.
-

Using the Battery

Checking the Battery Level

Press the power button once to check the battery level.

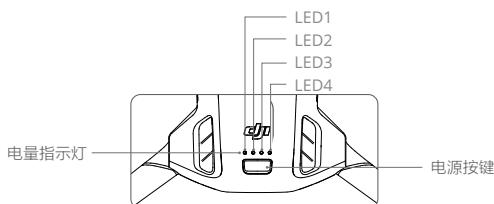

The battery level LEDs display the power level of the battery during charging and discharging. The statuses of the LEDs are defined below:

Battery Level LEDs

○ : LED is on ☀ : LED is flashing ○ : LED is off

LED1	LED2	LED3	LED4	Battery Level
○	○	○	○	88%-100%
○	○	○	☀	75%-87%
○	○	○	○	63%-74%
○	○	☀	○	50%-62%
○	○	○	○	38%-49%
○	☀	○	○	25%-37%
○	○	○	○	13%-24%
☀	○	○	○	1%-12%

Powering On/Off

Press the power button once and then press again and hold for two seconds to power the aircraft on or off. The battery level LEDs display the battery level when the aircraft is powered on. The battery level LEDs turn off when the aircraft is powered off.

When the aircraft is on, press the power button once and the four battery level LEDs will blink for three seconds. If LEDs 3 and 4 blink simultaneously without the power button being pressed, this indicates the battery is malfunctioning. Remove the battery from the aircraft, insert the battery again and make sure that it is securely mounted.

Low Temperature Notice

1. Battery capacity is significantly reduced when flying at low temperatures from -10° to 5° C (14° to 41° F). It is recommended to hover the aircraft in place for a while to heat the battery. Make sure to fully charge the battery before takeoff.
2. Batteries cannot be used in extremely low-temperature environments of lower than -10° C (14° F).
3. To ensure optimal performance, keep the battery temperature above 20° C (68° F).

- The reduced battery capacity in low-temperature environments reduces the wind speed resistance performance of the aircraft. Fly with caution.
- Fly with extra caution at high sea levels.

⚠ • In cold environments, insert the battery into the battery compartment and turn on the aircraft to warm up before taking off.

Charging the Battery

Fully charge the battery before each use. It is recommended to use the charging devices provided by DJI, such as the DJI Mini 3 Pro Two-Way Charging Hub, DJI 30W USB-C Charger, or other USB Power Delivery chargers. The DJI Mini 3 Pro Two-Way Charging Hub and the DJI 30W USB-C Charger are both optional accessories. Visit the official DJI online store for more information.

⚠ • When you charge the battery mounted to the aircraft or inserted into the DJI Mini 3 Pro Two-Way Charging Hub, the maximum charging power supported is 30 W.

Using the Charging Hub

When used with a USB charger, the DJI Mini 3 Pro Two-Way Charging Hub can charge up to three Intelligent Flight Batteries or Intelligent Flight Batteries Plus in sequence from high to low power level. When used with the DJI 30W USB-C Charger, the charging hub can fully charge one Intelligent Flight Battery in approximately 56 minutes, and one Intelligent Flight Battery Plus in approximately 78 minutes.

When the charging hub is connected to AC power through a USB charger, users can connect both the Intelligent Flight Batteries and an external device (such as a remote controller or smart phone) to the hub to charge. The batteries will be charged before the external device by default. When the charging hub is not connected to AC power, insert the Intelligent Flight Batteries into the hub and connect an external device to the USB port to charge the device, using the Intelligent Flight Batteries as power banks. Refer to the DJI Mini 3 Pro Two-Way Charging Hub User Guide for more details.

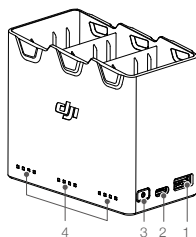

1. USB port
2. Power Port (USB-C)
3. Function Button
4. Status LEDs

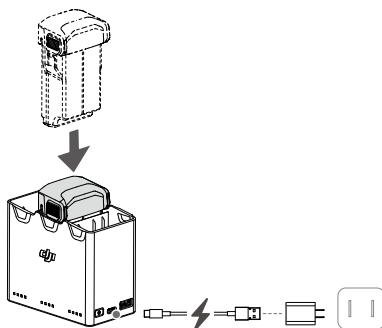

How to Charge

1. Insert the batteries into the charging hub until there is a click.
2. Connect the charging hub to a power outlet (100-240V, 50/60 Hz) using a USB-C cable and a DJI 30W USB-C charger or other USB Power Delivery chargers.
3. The battery with the highest power level will be charged first. The rest will be charged in sequence according to their power levels. The corresponding status LEDs will display the charging status (see table below). After the battery is fully charged, the corresponding LEDs will change to solid green.

Status LEDs Descriptions

Charging Status

Blinking Pattern	Description
Status LEDs in an array blink successively (quickly)	The battery in the corresponding battery port is being charged using a Quick Charge charger.
Status LEDs in an array blink successively (slowly)	The battery in the corresponding battery port is being charged using a normal charger.
Status LEDs in an array are solid	The battery in the corresponding battery port is fully charged.
All status LEDs blink in sequence	No battery is inserted.

Battery Level

Each battery port of the charging hub has its corresponding status LED array, from LED1 to LED4 (left to right). Check battery levels by pressing the function button once. The battery level LED statuses are the same as those on the aircraft. For details, refer to aircraft battery level LEDs statuses and descriptions.

Abnormal Status

The LED status for battery abnormality is the same as that on the aircraft. Refer to the Battery Protection Mechanisms section for details.



- It is recommended to use a DJI 30W USB-C Charger or other USB Power Delivery chargers to power the charging hub.
- The environmental temperature affects the charging speed. Charging is faster in a well-ventilated environment at 25° C.
- The charging hub is only compatible with BWX162-2453-7.38 Intelligent Flight Battery and BWX162-3850-7.38 Intelligent Flight Battery Plus. DO NOT use the charging hub with other battery models.
- Place the charging hub on a flat and steady surface when in use. Make sure the device is properly insulated to prevent fire hazards.
- DO NOT touch the metal terminals on the charging hub.
- Clean the metal terminals with a clean, dry cloth if there is any noticeable buildup.

Using A Charger

1. Ensure the battery has been correctly installed on the aircraft.
2. Connect the USB charger to an AC outlet (100-240V, 50/60 Hz). Use a power adapter if necessary.
3. Connect the USB charger to the charging port on the aircraft using a USB-C cable.
4. The battery level LEDs display the current battery level during charging.
5. The battery is fully charged when all the battery level LEDs emit a solid light. Remove the charger after charging is complete.

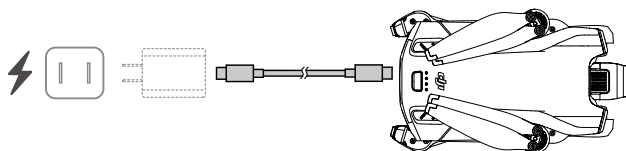

- ⚠ • The battery cannot be charged if the aircraft is powered on.
- The maximum charge voltage for the aircraft charging port is 15 V.
- DO NOT charge an Intelligent Flight Battery immediately after flight as it may be too hot. Wait for the battery to cool down to room temperature before charging again.
- The charger stops charging the battery if the cell temperature is not within 5° to 40° C (41° to 104° F). The ideal charging temperature is from 22° to 28° C (71.6° to 82.4° F).
- Fully charge the battery at least once every three months to maintain battery health. It is recommended to use the DJI 30W USB-C Charger or other USB Power Delivery chargers.

- 💡 • When using the DJI 30W USB-C Charger, the charging time for Mini 3 Pro Intelligent Flight Battery is approximately 1 hour and 4 minutes, while for Mini 3 Pro Intelligent Flight Battery Plus it is approximately 1 hour and 41 minutes.
- For safety purposes, keep the batteries at a low power level in transit. Before transportation, it is recommended to discharge the batteries to 30% or lower.

The table below shows the battery level LED statuses during charging.

LED1	LED2	LED3	LED4	Battery Level
☀	☀	○	○	1%-50%
☀	☀	☀	○	51%-75%
☀	☀	☀	☀	76%-99%
○	○	○	○	100%

- 💡 • The blinking frequency of the battery level LEDs differs depending on the USB charger used. If the charging speed is fast, the battery level LEDs will blink quickly.
- If the battery is not correctly inserted into the aircraft, LEDs 3 and 4 will blink simultaneously. Insert the battery again and make sure it is securely mounted.
- The four LEDs blinking simultaneously indicates the battery is damaged.

Battery Protection Mechanisms

The battery LEDs can display battery protection notifications triggered by abnormal charging conditions.

Battery Protection Mechanisms					
LED1	LED2	LED3	LED4	Blinking Pattern	Status
○	☀	○	○	LED2 blinks twice per second	Overcurrent detected
○	☀	○	○	LED2 blinks three times per second	Short circuit detected
○	○	☀	○	LED3 blinks twice per second	Overcharge detected
○	○	☀	○	LED3 blinks three times per second	Over-voltage charger detected
○	○	○	☀	LED4 blinks twice per second	Charging temperature is too low
○	○	○	☀	LED4 blinks three times per second	Charging temperature is too high

If any of the battery protection mechanisms are activated, unplug the charger, and plug it in again to resume charging. If the charging temperature is abnormal, wait for it to return to normal and the battery will automatically resume charging without the need to unplug and plug the charger again.

Inserting the Intelligent Flight Battery

Insert the Intelligent Flight Battery or Intelligent Flight Battery Plus into the battery compartment of the aircraft. Make sure the battery is fully inserted with a clicking sound, which indicates the battery buckles are securely fastened.

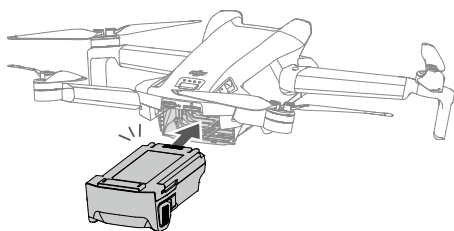

-
- ⚠** • Ensure the battery is inserted with a clicking sound. **DO NOT** launch the aircraft when the battery is not securely mounted, as this may cause poor contact between the battery and the aircraft and present hazards.
-

Removing the Intelligent Flight Battery

Press the textured part of the battery buckles on the sides of the battery to remove it from the compartment.

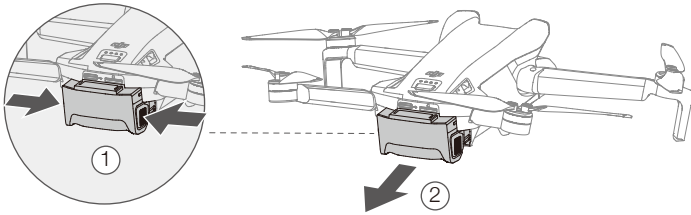

- DO NOT insert or remove the battery while the aircraft is powered on.
 - Make sure the battery is mounted securely.
-

Gimbal and Camera

Gimbal Profile

The DJI Mini 3 3-axis gimbal stabilizes the camera, allowing you to capture clear and steady images and videos at high flight speed. The gimbal has a control tilt range of -90° to $+60^{\circ}$, and two control roll angles of -90° (portrait) and 0° (landscape).

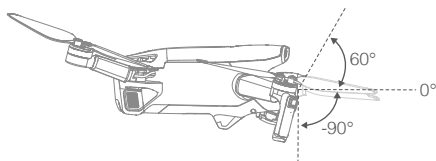

Use the gimbal dial on the remote controller to control the tilt of the camera. Alternatively, do so through the camera view in DJI Fly. Press the screen until an adjustment bar appears and drag up and down to control the camera's tilt. Tap the Landscape/Portrait Mode Switch in DJI Fly to switch between the two gimbal roll angles. The roll axis will rotate to -90° when Portrait Mode is enabled, and back to 0° in Landscape Mode.

Gimbal Mode

Two gimbal operation modes are available. Switch between the different operation modes in DJI Fly.

Follow Mode: The angle between the gimbal's orientation and aircraft front remains constant at all times. Users can adjust the gimbal tilt. This mode is suitable for shooting stills.

FPV Mode: When the aircraft is flying forward, the gimbal synchronizes with the movement of the aircraft to provide a first-person flying experience.



- Make sure there are no stickers or objects on the gimbal before taking off. When the aircraft is powered on, DO NOT tap or knock the gimbal. Take off from open and flat ground to protect the gimbal.
- Precision elements in the gimbal may be damaged in a collision or impact, which may cause the gimbal to function abnormally.
- Avoid getting dust or sand on the gimbal, especially in the gimbal motors.
- A gimbal motor may enter protection mode in the following situations: a. The aircraft is on uneven ground and the gimbal is impacted. b. The gimbal experiences excessive external force, such as during a collision.
- DO NOT apply external force to the gimbal after the gimbal is powered on. DO NOT add any extra payload to the gimbal as this may cause the gimbal to function abnormally or even lead to permanent motor damage.
- Make sure to remove the gimbal protector before powering on the aircraft. Make sure to mount the gimbal protector when the aircraft is not in use.
- Flying in heavy fog or clouds may make the gimbal wet, leading to temporary failure. The gimbal will recover full functionality once it is dry.

Camera

DJI Mini 3 uses a 1/1.3-in CMOS sensor. The aperture of the camera is F1.7 and shoots from 1 m to infinity.

The DJI Mini 3 camera can take 12MP stills and supports shooting modes such as Single, AEB, Timed Shot and Panorama. It also supports recording 4K videos.



- Make sure the temperature and humidity are suitable for the camera during use and storage.
 - Use a lens cleanser to clean the lens to avoid damage or poor image quality.
 - DO NOT block any ventilation holes on the camera as the heat generated may damage the device and injure the user.
-

Storing Photos and Videos

DJI Mini 3 supports the use of a microSD card to store your photos and videos. A microSD card with a UHS-I Speed Grade 3 rating or above is required due to the fast read and write speeds necessary for high-resolution video data. Refer to the Specifications for more information about recommended microSD cards.

Without a microSD card inserted into the aircraft microSD card slot:

- When using the DJI RC-N1 remote controller, the user can still capture single photos or record 720p videos. The file will be stored on the mobile device.
 - When using the DJI RC remote controller, the user cannot capture photos or record videos. Insert a recommended microSD card into the aircraft microSD card slot in advance.
-



- DO NOT remove the microSD card from the aircraft while it is powered on, or the microSD card may be damaged.
 - Check camera settings before use to ensure they are configured correctly.
 - Before shooting important photos or videos, shoot a few images to test whether the camera is operating correctly.
 - Photos or videos cannot be transferred from the microSD card in the aircraft using DJI Fly if the aircraft is powered off.
 - Make sure to power off the aircraft correctly. Otherwise, the camera parameters will not be saved and any recorded videos may be affected. DJI is not responsible for any loss caused by an image or video recorded in a way that is not machine-readable.
-

Remote Controller

This section describes the features of the remote controller and includes instructions for controlling the aircraft and the camera.

Remote Controller

DJI RC

When used with DJI Mini 3, DJI RC remote controller features OcuSync 2.0 video transmission, works at both 2.4 GHz and 5.8 GHz frequency bands. It is capable of selecting the best transmission channel automatically and can transmit 720p 30fps HD live view from the aircraft to the remote controller at a distance of up to 10 km (6 mi) (compliant with FCC standards, and measured in a wide open area without interference).

The DJI RC is also equipped with a 5.5-in touchscreen (1920×1080 pixel resolution) and a wide range of controls and customizable buttons, enabling users to easily control the aircraft and remotely change the aircraft settings. The built-in 5200 mAh battery with a power of 18.72 Wh provides the remote controller with a maximum operating time of four hours. The DJI RC comes with many other functions such as Wi-Fi connection, built-in GNSS (GPS+BEIDOU+GALILEO), Bluetooth, built-in speakers, detachable control sticks, and microSD storage.

Using the Remote Controller

Powering On/Off

Press the power button once to check the current battery level.

Press once then press again and hold to power the remote controller on or off.

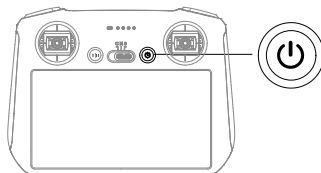

Charging the Battery

Use a USB-C cable to connect a USB charger to the USB-C port of the remote controller. The battery can be fully charged in about 1 hour and 30 minutes with a maximum charging power of 15 W (5V/3A).

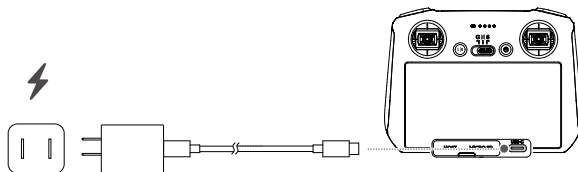

- It is recommended to use a USB Power Delivery charger.

Controlling the Gimbal and Camera

Focus/Shutter Button: Press halfway down to auto-focus and press all the way down to take a photo.

Record Button: Press once to start or stop recording.

Camera Control Dial: Adjust the zoom.

Gimbal Dial: Control the tilt of the gimbal.

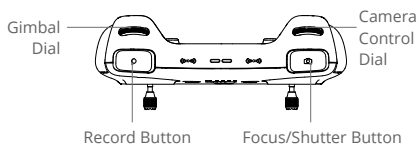

Controlling the Aircraft

The control sticks control the aircraft's orientation (pan), forward/backward movement (pitch), altitude (throttle), and left/right movement (roll). The control stick mode determines the function of each control stick movement. Three preprogrammed modes (Mode 1, Mode 2, and Mode 3) are available and custom modes can be configured in DJI Fly.

Mode 1

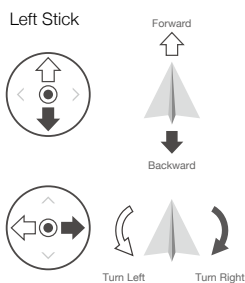

Right Stick

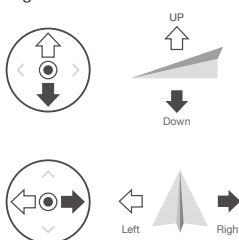

Mode 2

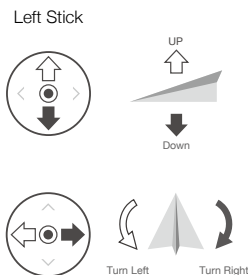

Right Stick

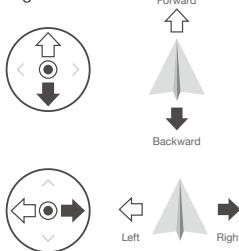

Mode 3

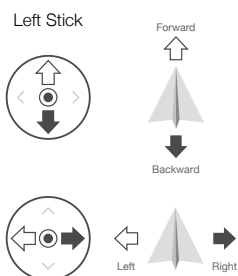

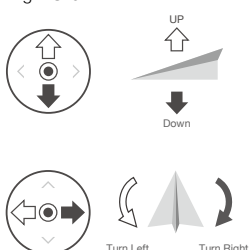

Right Stick

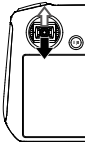
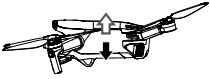
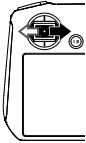
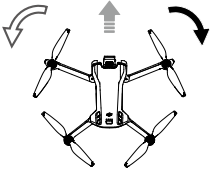
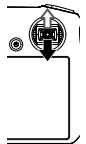
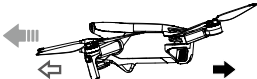
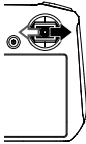

The default control mode of the remote controller is Mode 2. In this manual, Mode 2 is used as the example to illustrate how to use the control sticks.

- ☰ • **Stick Neutral/Center Point:** Control sticks are in the center.
- **Moving the control stick:** The control stick is pushed away from the center position.

Remote Controller (Mode 2)	Aircraft (← Indicates Nose Direction)	Remarks
		<p>Throttle Stick: Moving the left stick up or down changes the aircraft's altitude. Push the stick up to ascend and down to descend. The more the stick is pushed away from the center position, the faster the aircraft will change altitude. Push the stick gently to prevent sudden and unexpected changes in altitude.</p>
		<p>Yaw Stick: Moving the left stick to the left or right controls the orientation of the aircraft. Push the stick left to rotate the aircraft counter-clockwise and right to rotate the aircraft clockwise. The more the stick is pushed away from the center position, the faster the aircraft will rotate.</p>
		<p>Pitch Stick: Moving the right stick up and down changes the aircraft's pitch. Push the stick up to fly forward and down to fly backward. The more the stick is pushed away from the center position, the faster the aircraft will move.</p>
		<p>Roll Stick: Moving the right stick to the left or right changes the aircraft's roll. Push the stick left to fly left and right to fly right. The more the stick is pushed away from the center position, the faster the aircraft will move.</p>

Flight Mode Switch

Toggle the switch to select the desired flight mode.

Position	Flight Mode
S	Sport Mode
N	Normal Mode
C	Cine Mode

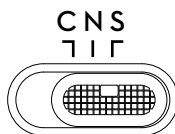

Flight Pause/RTH Button

Press once to make the aircraft brake and hover in place. Press and hold the button until the remote controller beeps to start RTH, the aircraft will return to the last recorded Home Point. Press this button again to cancel RTH and to regain control of the aircraft.

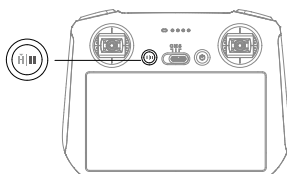

Customizable Buttons

Go to System Settings in DJI Fly and select Control to set the functions of the customizable C1 and C2 buttons.

Status LED and Battery Level LEDs Description

Status LED

Blinking Pattern	Description	
—	Solid red	Disconnected from the aircraft
.....	Blinking red	The battery level of the aircraft is low
—	Solid green	Connected with the aircraft
.....	Blinking blue	The remote controller is linking to an aircraft
—	Solid yellow	Firmware update failed
—	Solid blue	Firmware update successful
.....	Blinking yellow	The battery level of the remote controller is low
.....	Blinking cyan	Control sticks not centered

Battery Level LEDs

Blinking Pattern				Battery Level
●	●	●	●	75%~100%
●	●	●	○	50%~75%
●	●	○	○	25%~50%
●	○	○	○	1%~25%

Remote Controller Alert

The remote controller beeps when there is an error or warning. Pay attention when prompts appear on the touch screen or in DJI Fly. Slide down from the top and select Mute to disable all alerts, or slide the volume bar to 0 to disable some alerts.

The remote controller sounds an alert during RTH. The RTH alert cannot be cancelled. The remote controller sounds an alert when the battery level of the remote controller is low (6% to 10%). A low battery level alert can be cancelled by pressing the power button. The critical low battery level alert, which is triggered when the battery level is less than 5%, cannot be cancelled.

Optimal Transmission Zone

The signal between the aircraft and the remote controller is most reliable when the remote controller is positioned towards the aircraft as depicted below.

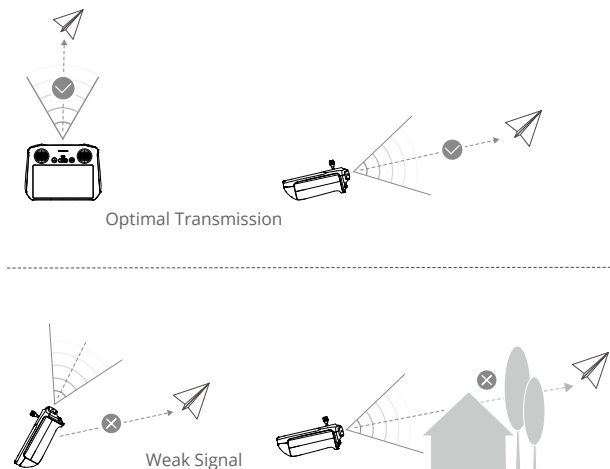

- DO NOT use other wireless devices operating at the same frequency as the remote controller. Otherwise, the remote controller will experience interference.
- A prompt will be displayed in DJI Fly if the transmission signal is weak during flight. Adjust the remote controller orientation to make sure that the aircraft is in the optimal transmission range.

Linking the Remote Controller

The remote controller is already linked to the aircraft when purchased together as a combo. Otherwise, follow the steps below to link the remote controller and the aircraft after activation.

1. Power on the aircraft and the remote controller.
2. Launch DJI Fly.
3. In camera view, tap ●●● and select Control and then Pair to Aircraft (Link).
4. Press and hold the power button on the aircraft for more than four seconds. The aircraft will beep once when it is ready to link. After the linking is successful, the aircraft will beep twice and the battery level LEDs of the remote controller will appear on and solid.



- Make sure the remote controller is within 0.5 m of the aircraft during the linking.
- The remote controller will automatically unlink from an aircraft if a new remote controller is linked to the same aircraft.
- Turn off Bluetooth and Wi-Fi of the remote controller for optimal video transmission.



- Fully charge the remote controller before each flight. The remote controller sounds an alert when the battery level is low.
 - If the remote controller is powered on and not in use for five minutes, an alert will sound. After six minutes, the remote controller automatically powers off. Move the control sticks or press any button to cancel the alert.
 - Fully charge the battery at least once every three months to maintain the battery's health.
-

Operating the Touchscreen

Home

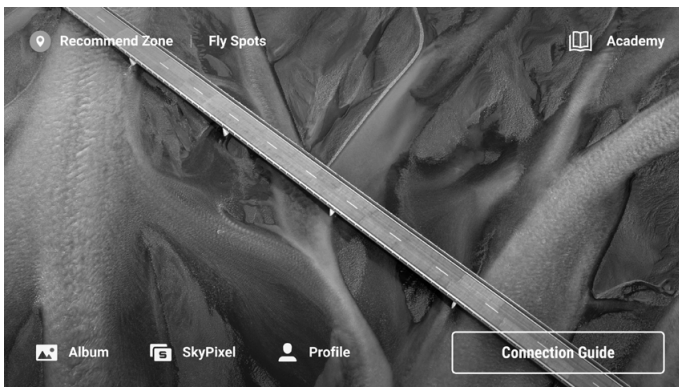

Operations

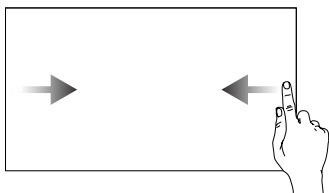

Slide from the left or right to the center of the screen to return to the previous screen.

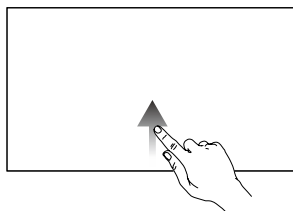

Slide up from the bottom of the screen to return to DJI Fly.

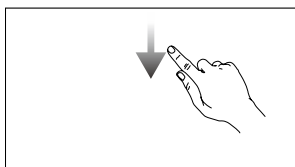

Slide down from the top of the screen to open the status bar when in DJI Fly. The status bar displays the time, Wi-Fi signal, battery level of the remote controller, etc.

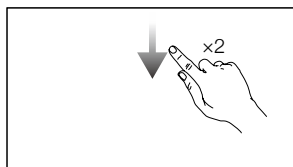

Slide down twice from the top of the screen to open Quick Settings when in DJI Fly.

Quick Settings

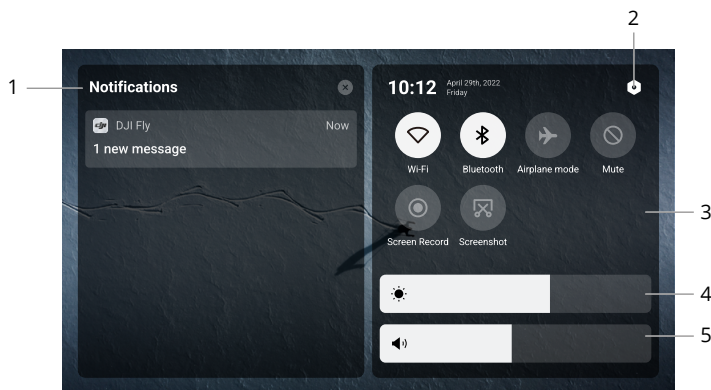







1. Notifications

Tap to check system notifications.

2. System Settings

Tap to access system settings and configure the Bluetooth, volume, network, etc. You can also view the Guide to learn more about the controls and status LEDs.

3. Shortcuts

- : Tap to enable or disable Wi-Fi. Hold to enter settings and then connect to or add a Wi-Fi network.
- : Tap to enable or disable Bluetooth. Hold to enter settings and connect with nearby Bluetooth devices.
- : Tap to enable Airplane mode. Wi-Fi and Bluetooth will be disabled.
- : Tap to turn off system notifications and disable all alerts.
- : Tap to start recording the screen. The function will be available only after a microSD card is inserted into the microSD slot on the remote controller.
- : Tap to take a screenshot. The function will be available only after a microSD card is inserted into the microSD slot on the remote controller.

4. Adjusting Brightness

Slide the bar to adjust the screen brightness.

5. Adjusting Volume

Slide the bar to adjust the volume.

Advanced Features

Calibrating the Compass

The compass may need to be calibrated after the remote controller is used in areas with electromagnetic interference. A warning prompt will appear if the compass of the remote controller requires calibration. Tap the warning prompt to start calibrating. In other cases, follow the steps below to calibrate your remote controller.

1. Power on the remote controller, and enter Quick Settings.
2. Tap  to enter system settings, scroll down and tap Compass.
3. Follow the on-screen instructions to calibrate the compass.
4. A prompt will be displayed when the calibration is successful.

DJI RC-N1

When used with DJI Mini 3, DJI RC-N1 features OcuSync 2.0 video transmission, works at both 2.4 GHz and 5.8 GHz frequency bands, is capable of selecting the best transmission channel automatically, and offers 720p 30fps HD live view transmission from the aircraft to DJI Fly on a mobile device (depending on mobile device performance) at a maximum transmission range of 10 km (6 mi) (compliant with FCC standards, and measured in a wide open area without interference). Users can control the aircraft and change the settings easily within this range. The built-in battery has a capacity of 5200 mAh and power of 18.72 Wh that supports a maximum run time of six hours. The remote controller charges Android mobile devices automatically with a charging rate of 500 mA@5 V. Charging for iOS devices is disabled by default. To charge iOS devices, make sure that the charging function is enabled in DJI Fly each time the remote controller is powered on.

Powering On/Off

Press the power button once to check the current battery level. If the battery level is too low, recharge before use.

Press once then press again and hold for two seconds to power the remote controller on or off.

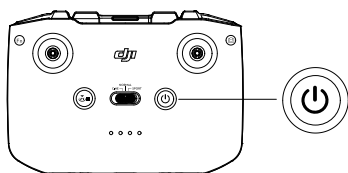

Charging the Battery

Use a USB-C cable to connect a USB charger to the USB-C port of the remote controller.

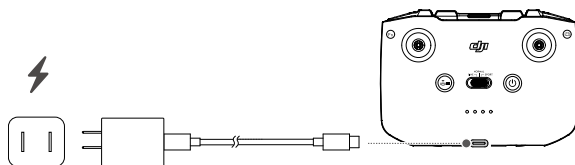

Controlling the Gimbal and Camera

Shutter/Record Button: Press once to take a photo or to start or stop recording.

Photo/Video Toggle: Press once to switch between photo and video mode.

Gimbal Dial: For controlling the tilt of the gimbal.

Press and hold the customizable button and then use the gimbal dial to zoom in or out.

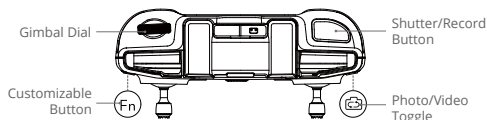

Controlling the Aircraft

The control sticks control the aircraft's orientation (pan), forward/backward movement (pitch), altitude (throttle), and left/right movement (roll). The control stick mode determines the function of each control stick movement. Three preprogrammed modes (Mode 1, Mode 2, and Mode 3) are available and custom modes can be configured in DJI Fly.

Mode 1

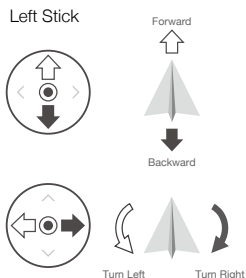

Right Stick

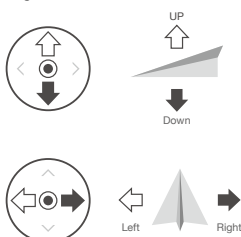

Mode 2

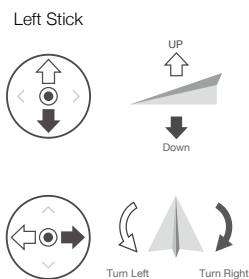

Right Stick

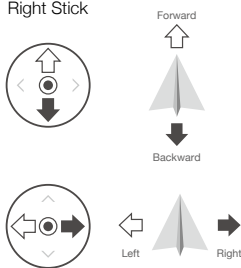

Mode 3

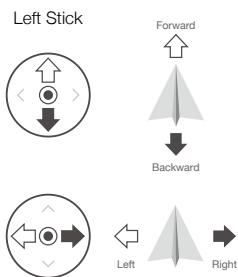

Right Stick

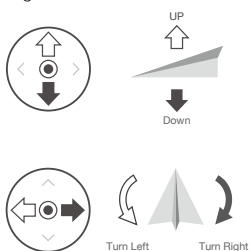







The default control mode of the remote controller is Mode 2. In this manual, Mode 2 is used as the example to illustrate how to use the control sticks.

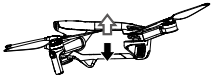

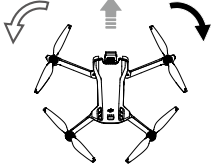
Stick Neutral/Center Point: Control sticks are in the center.

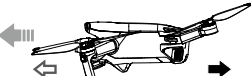
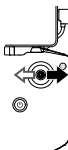
Moving the control stick: The control stick is pushed away from the center position.

Remote Controller (Mode 2)	Aircraft (← Indicates Nose Direction)	Remarks
		<p>Throttle Stick: Moving the left stick up or down changes the aircraft's altitude. Push the stick up to ascend and down to descend. The more the stick is pushed away from the center position, the faster the aircraft will change altitude. Push the stick gently to prevent sudden and unexpected changes in altitude.</p>
		<p>Yaw Stick: Moving the left stick to the left or right controls the orientation of the aircraft. Push the stick left to rotate the aircraft counter-clockwise and right to rotate the aircraft clockwise. The more the stick is pushed away from the center position, the faster the aircraft will rotate.</p>
		<p>Pitch Stick: Moving the right stick up and down changes the aircraft's pitch. Push the stick up to fly forward and down to fly backward. The more the stick is pushed away from the center position, the faster the aircraft will move.</p>
		<p>Roll Stick: Moving the right stick to the left or right changes the aircraft's roll. Push the stick left to fly left and right to fly right. The more the stick is pushed away from the center position, the faster the aircraft will move.</p>

Flight Mode Switch

Toggle the switch to select the desired flight mode.

Position	Flight Mode
Sport	Sport Mode
Normal	Normal Mode
Cine	Cine Mode



Flight Pause/RTH Button

Press once to make the aircraft brake and hover in place. Press and hold the button until the remote controller beeps to start RTH. The aircraft will return to the last recorded Home Point. Press this button again to cancel RTH and to regain control of the aircraft.

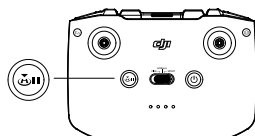

Customizable Button

To customize the function of this button, go to System Settings in DJI Fly and select Control. Customizable functions include recentering the gimbal and toggling between the map and live view.

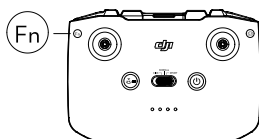

Remote Controller Alert

The remote controller sounds an alert during RTH. The RTH alert cannot be cancelled. The remote controller sounds an alert when the battery level of the remote controller is low (6% to 10%). A low battery level alert can be cancelled by pressing the power button. The critical low battery level alert, which is triggered when the battery level is less than 5%, cannot be cancelled.

Optimal Transmission Zone

The signal between the aircraft and the remote controller is most reliable when the remote controller is positioned towards the aircraft as depicted below.

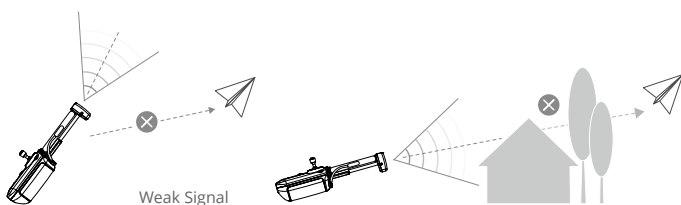
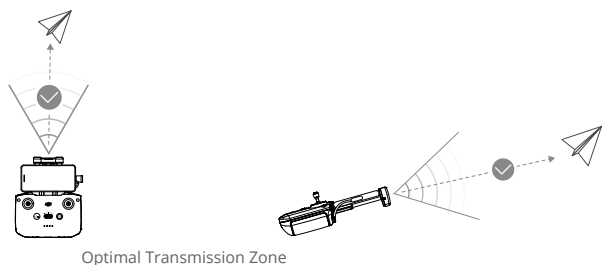

Linking the Remote Controller

The remote controller is already linked to the aircraft when purchased together as a combo. Otherwise, follow the steps below to link the remote controller and the aircraft after activation.

1. Power on the aircraft and the remote controller.
2. Launch DJI Fly.
3. In camera view, tap ●●● and select Control and then Pair to Aircraft (Link).
4. Press and hold the power button of the aircraft for more than four seconds. The aircraft will beep once when it is ready to link. After the linking is successful, the aircraft will beep twice and the battery level LEDs of the remote controller will appear on and solid.



- Make sure the remote controller is within 0.5 m of the aircraft during the linking.
- The remote controller will automatically unlink from an aircraft if a new remote controller is linked to the same aircraft.
- Turn off Bluetooth and Wi-Fi of the mobile device for optimal video transmission.



- Fully charge the remote controller before each flight. The remote controller sounds an alert when the battery level is low.
- If the remote controller is powered on and not in use for five minutes, an alert will sound. After six minutes, the remote controller automatically powers off. Move the control sticks or press any button to cancel the alert.
- Adjust the mobile device holder to make sure your mobile device is secure.
- Fully charge the battery at least once every three months to maintain the battery's health.

DJI Fly App

This section introduces the main functions of the DJI Fly app.

DJI Fly App

Home

Launch DJI Fly and enter the home screen.



Fly Spots

View or share suitable flight and shooting locations nearby, learn more about GEO Zones, and preview aerial photos of different locations taken by other users.

Academy

Tap the icon in the top right corner to enter Academy and view product tutorials, flight tips, flight safety notices, and manual documents.

Album

View photos and videos on the aircraft and your mobile device or on the DJI RC remote controller. Tap Create and select Templates or Pro. Templates provide an auto-edit feature for imported footage. Pro allows users to edit footage manually.



- The DJI RC remote controller only supports viewing photos and videos on the aircraft and the remote controller. The Create function is not available on the DJI RC remote controller.

SkyPixel

Enter SkyPixel to view videos and photos shared by users.

Profile

View account information, flight records; visit the DJI forum, online store; access the Find My Drone feature, and other settings such as firmware updates, camera view, cached data, account privacy, and language.

Camera View

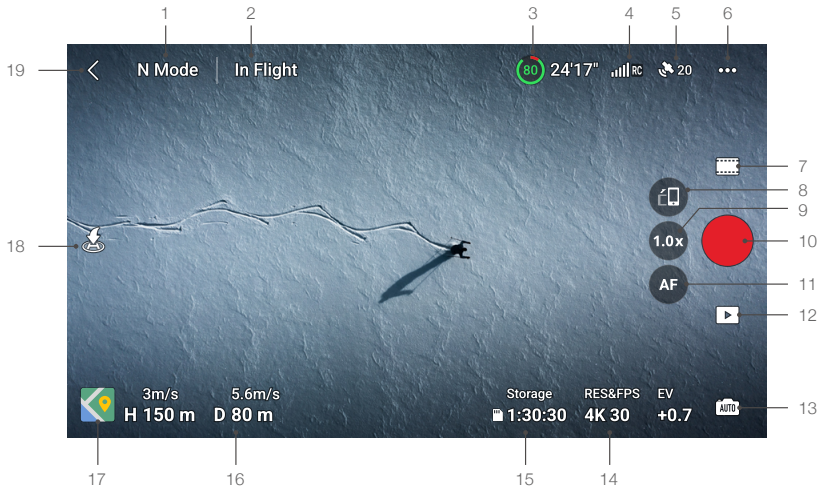

1. Flight Mode

N Mode: Displays the current flight mode.

2. System Status Bar

In Flight: Indicates the aircraft flight status and displays various warning messages. Tap to view more information when a warning prompt appears.

3. Battery Information

80 24'17" : Displays the current battery level and remaining flight time.

4. Video Downlink Signal Strength

RC : Displays the video downlink signal strength between the aircraft and the remote controller.

5. GNSS Status

20 : Displays the current GNSS signal strength. Tap to check the GNSS signal status. The Home Point can be updated when the icon is white, which indicates the GNSS signal is strong.

6. System Settings

... : System settings provide information about safety, control, the camera, and transmission.

• Safety

RTH: Tap to set the Return to Home Altitude and update the Home Point.

Flight Protection: Tap to set the max altitude and the max distance for flights.

Sensors: Tap to view the IMU and compass statuses and start calibration if necessary.

Unlock GEO Zone: Tap to view information about unlocking GEO Zones.

The Find My Drone feature uses the map to find the location of the aircraft on the ground.

Battery: Tap to view battery information such as battery cell status, serial number, and number of times charged.

Advanced Safety Settings include the behavior settings for the aircraft when remote controller signals are lost and stopping the propellers mid-flight during emergencies.

The behavior of the aircraft when remote controller signals are lost can be set to Return to Home, Descend, or Hover.

“Emergency Only” indicates that the motors can only be stopped mid-flight in case of an emergency, such as a collision, a motor stalling, the aircraft rolling in the air, or the aircraft being out of control and ascending or descending quickly. “Anytime” indicates that the motors can be stopped mid-flight anytime once the user performs a combination stick command (CSC). Note that the user needs to hold the control sticks for 2 s while performing the CSC to stop the motors mid-flight.

 • Stopping the motors mid-flight will cause the aircraft to crash.

• Control

Aircraft Settings: Set measurement units.

Gimbal Settings: Tap to set the gimbal mode, enter advanced settings, perform gimbal calibration, and recenter or tilt the gimbal down.

Remote Controller Settings: Tap to set the function of the customizable button, calibrate the remote controller, switch control stick modes (Mode 1, Mode 2, Mode 3, or custom mode), or set the advanced settings of the remote controller.

Beginner Flight Tutorial: View the flight tutorial.

Connect to the Aircraft: Tap to start linking when the aircraft is not linked to the remote controller.

• Camera

Camera Parameter Settings: Displays different settings according to the shooting mode.

General Settings: Tap to view and set histogram, overexposure warning, peaking level, gridlines, and white balance.

Storage Location: Tap to check microSD card capacity and format. Choose to auto synchronize HD photos to the mobile device, to enable cache during recording and adjust the max video cache capacity settings.

Reset Camera Settings: Tap to restore camera parameters to the default settings.

 • The DJI RC remote controller does not support the Auto Sync HD Photos function.

• Transmission

A livestreaming platform can be selected to broadcast the camera view in real time.

The frequency band and channel mode can also be set in the transmission settings.

 • The DJI RC remote controller does not support the live streaming function.

• About

View device information, firmware information, app version, battery version, and more.

7. Shooting Modes

Photo: Single, AEB, Timed Shot.

Video

QuickShots: Choose from Dronie, Rocket, Circle, Helix, and Boomerang.

Panorama: Choose from Sphere, 180°, and Wide Angle.

8. Landscape/Portrait Mode Switch

 : Tap to switch between Landscape and Portrait modes. The camera will rotate 90 degrees when switching to Portrait mode, for shooting portrait videos and photos.



9. Zoom

 : The icon shows the zoom ratio. Tap to adjust the zoom ratio. Tap and hold the icon to expand the zoom bar and slide on the bar to adjust the zoom ratio.

10. Shutter/Record Button

 : Tap to take a photo or to start or stop recording a video.

11. Focus Button

 /  : Tap the icon to switch the focus mode. Tap and hold the icon to expand the focus bar and slide on the bar to focus the camera.

12. Playback

 : Tap to enter playback and preview photos and videos as soon as they are captured.

13. Camera Mode Switch

 : Choose between Auto and Pro modes when in photo mode. The parameters differ with each mode.

14. Shooting Parameters

RES&FPS EV
4K 30 +0.7 : Displays the current shootings parameters. Tap to access parameter settings.

15. microSD Card Information

 Storage
1:30:30 : Displays the remaining number of photos or video recording time on the current microSD card. Tap to view the available capacity of the microSD card.

16. Flight Telemetry

H 150m : Vertical distance from the aircraft to the Home Point.

D 80m : Horizontal distance from the aircraft to the Home Point.

3m/s : Vertical speed of the aircraft.

5.6m/s : Horizontal speed of the aircraft.

17. Map

 : Tap to switch to the Attitude Indicator, which displays information such as the orientation and tilt angle of the aircraft, as well as the locations of the remote controller and the Home Point.

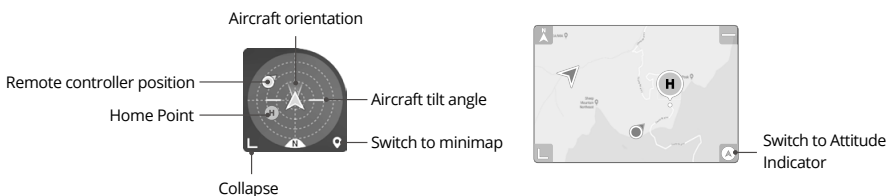

18. Auto Takeoff/Landing/RTH

: Tap the icon. When the prompt appears, press and hold the button to initiate auto takeoff or landing.

: Tap to initiate Smart RTH and have the aircraft return to the last recorded Home Point.

19. Back

: Tap to return to the home screen.

Tap and hold anywhere on the screen in the camera view until the gimbal adjustment bar appears. Slide on the bar to adjust the gimbal angle.

Tap on the screen to enable focus or spot metering. Focus or spot metering will display differently depending on the focus mode, exposure mode, and spot metering mode. After using spot metering, tap and hold on the screen to lock the exposure. To unlock the exposure, tap and hold on the screen again.



- Fully charge your device before launching DJI Fly.
 - Mobile cellular data is required when using DJI Fly. Contact your wireless carrier for data charges.
 - DO NOT answer phone calls, text, or use other mobile functions during flight if you are using a mobile phone as your display device.
 - Read all safety prompts, warning messages, and disclaimers carefully. Familiarize yourself with relevant regulations in your area. You are solely responsible for being aware of all relevant regulations and flying in a way that is compliant.
 - a) Read and understand the warning messages before using the auto-takeoff and auto-landing features.
 - b) Read and understand the warning messages and disclaimers before setting the altitude beyond the default limit.
 - c) Read and understand the warning messages and disclaimers before switching flight modes.
 - d) Read and understand the warning messages and disclaimer prompts near or in GEO zones.
 - e) Read and understand the warning messages before using the Intelligent Flight modes.
 - Land the aircraft immediately at a safe location if a prompt appears in the app instructing you to do so.
 - Review all warning messages on the checklist displayed in the app before each flight.
 - Use the in-app tutorial to practice your flight skills if you have never operated the aircraft or if you do not have sufficient experience to operate the aircraft with confidence.
 - Cache the map data of the area where you intend to fly the aircraft by connecting to the internet before each flight.
 - The app is designed to assist in your operations. Use your sound discretion and DO NOT rely on the app to control your aircraft. Your use of the app is subject to DJI Fly Terms of Use and DJI Privacy Policy. Read them carefully in the app.
-

Flight

This section describes safe flight practices and flight restrictions.

Flight

After completing the pre-flight preparation, it is recommended to train your flying skills and practice flying safely. Make sure that all flights are carried out in an open area. Strictly abide by local laws and regulations when flying. Read the Safety Guidelines before flight to ensure the safe use of the product.

Flight Environment Requirements

1. Do not operate the aircraft in severe weather conditions including wind speeds exceeding 10.7 m/s, snow, rain, and fog.
2. Only fly in open areas. Tall buildings and large metal structures may affect the accuracy of the onboard compass and GNSS system. It is recommended to keep the aircraft at least 10 m away from structures.
3. Avoid obstacles, crowds, high-voltage power lines, trees, and bodies of water (recommended height is at least 3 m above water).
4. Minimize interference by avoiding areas with high levels of electromagnetism such as locations near power lines, base stations, electrical substations, and broadcasting towers.
5. The performance of the aircraft and its battery is limited when flying at high altitudes. Fly with caution. The maximum service ceiling above sea level of the aircraft is 4,000 m (13,123 ft) when flying with the Intelligent Flight Battery. If the Intelligent Flight Battery Plus is used, the maximum service ceiling above sea level drops to 3,000 m (9,843 ft). If a propeller guard is installed on the aircraft with the Intelligent Flight Battery, the maximum service ceiling above sea level becomes 1,500 m (4,921 ft).
6. GNSS cannot be used on the aircraft in the polar regions. Use the Vision System instead.
7. DO NOT take off from moving objects such as cars and ships.
8. DO NOT use the aircraft in an environment at risk of a fire or explosion.

Flight Limits

GEO (Geospatial Environment Online) System

DJI's Geospatial Environment Online (GEO) System is a global information system that provides real-time information on flight safety and restriction updates and prevents UAVs from flying in restricted airspace. Under exceptional circumstances, restricted areas can be unlocked to allow flights in. Prior to that, the user must submit an unlocking request based on the current restriction level in the intended flight area. The GEO system may not fully comply with local laws and regulations. Users shall be responsible for their own flight safety and must consult with the local authorities on the relevant legal and regulatory requirements before requesting to unlock a flight in a restricted area. For more information about the GEO system, visit <https://www.dji.com/flysafe>.

Flight Limits

For safety reasons, flight limits are enabled by default to help users operate this aircraft safely. Users can set flight limits on height and distance. Altitude limits, distance limits, and GEO zones function concurrently to manage flight safety when GNSS is available. Only altitude can be limited when GNSS is unavailable.

Flight Altitude and Distance Limits

Maximum flight altitude restricts an aircraft's flight altitude, while maximum flight distance restricts an aircraft's flight radius around the Home Point. These limits can be set using the DJI Fly app for improved flight safety.

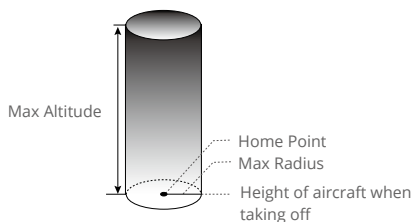

Home Point not manually updated during flight

When GNSS is available

	Flight Limits	DJI Fly App	Aircraft Status Indicator
Max Altitude	Altitude of the aircraft cannot exceed the specified value	Warning: height limit reached	Blinks green and red alternatively
Max Radius	Flight distance must be within the max radius	Warning: distance limit reached	

When GNSS is weak

	Flight Limits	DJI Fly App	Aircraft Status Indicator
Max Altitude	Height is restricted to 16 ft (5 m) when the GNSS signal is weak and Infrared Sensing System is operating. Height is restricted to 98 ft (30 m) when the GNSS signal is weak and Infrared Sensing System is not operating.	Warning: height limit reached.	Blinks red and green alternately
Max Radius	The restrictions on the radius are disabled and warning prompts cannot be received in the app.		



- There will be no altitude limit if the GNSS signal becomes weak during flight as long as the GNSS signal was stronger than weak (white or yellow signal bars) when the aircraft was powered on.
- If the aircraft is in a GEO zone and there is a weak or no GNSS signal, the aircraft status indicator will glow red for five seconds every twelve seconds.

- ⚠️ • If the aircraft reaches an altitude or radius limit, you can still control the aircraft, but you cannot fly it any further. If the aircraft flies out of the max radius, it will automatically fly back within range when the GNSS signal is strong.
 - For safety reasons, do not fly close to airports, highways, railway stations, railway lines, city centers, or other sensitive areas. Fly the aircraft only within your line of sight.
-

GEO Zones

All GEO zones are listed on the DJI official website at <http://www.dji.com/flysafe>. GEO zones are divided into different categories and include locations such as airports, airfields where manned aircraft operate at low altitudes, national borders, and sensitive locations such as power plants. You will receive a prompt in DJI Fly if your aircraft is approaching a GEO zone and the aircraft will be restricted from flying in the area.

Pre-Flight Checklist

1. Make sure the remote controller, mobile device, and Intelligent Flight Battery are fully charged.
2. Make sure the gimbal protector is removed.
3. Make sure the aircraft arms are unfolded.
4. Make sure the Intelligent Flight Battery and the propellers are mounted securely.
5. Make sure the gimbal and camera are functioning normally.
6. Make sure that there is nothing obstructing the motors and that they are functioning normally.
7. Make sure that DJI Fly is successfully connected to the aircraft.
8. Make sure all camera lenses and sensors are clean.
9. Only use genuine DJI parts or parts certified by DJI. Unauthorized parts or parts from non-DJI certified manufacturers may cause the system to malfunction and compromise safety.

Auto Takeoff/Landing



Auto Takeoff

Use the Auto Takeoff function:

1. Launch DJI Fly and enter the camera view.
2. Complete all steps in the pre-flight checklist.
3. Tap . If conditions are safe for takeoff, press and hold the button to confirm.
4. The aircraft will take off and hover approximately 1.2 m (3.9 ft) above the ground.

Auto Landing

Use the Auto Landing function:

1. Tap . If conditions are safe for landing, press and hold the button to confirm.
2. Auto landing can be cancelled by tapping .
3. If the Downward Vision System is working normally, Landing Protection will be enabled.
4. Motors will stop automatically after landing.

-
- ⚠️ • Choose the proper place for landing.
-

Starting/Stopping the Motors

Starting the Motors

Perform the Combination Stick Command (CSC) as shown below to start the motors. Once the motors have started spinning, release both sticks simultaneously.



Stopping the Motors

When the aircraft is on the ground and the motors are spinning, there are two ways to stop the motors:

Method 1: Push the throttle stick down and hold. The motors will stop after one second.

Method 2: Perform the same CSC used to start the motors and hold. The motors will stop after two seconds.

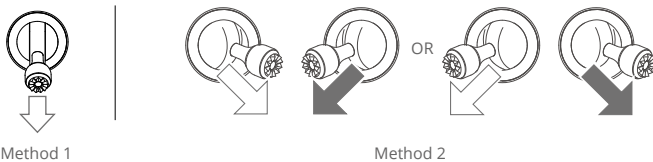

Stopping the Motors Mid-Flight

Stopping the motors mid-flight will cause the aircraft to crash. DO NOT stop the motors mid-flight unless you encounter an emergency situation, for example, if a collision has occurred, or if the aircraft is out of control and ascending or descending quickly, or the aircraft is rolling in the air. To stop the motors mid-flight, perform the same CSC used to start the motors. Note that the user needs to hold the control sticks for 2 s while performing the CSC to stop the motors. The default setting can be changed in DJI Fly.

Flight Test

Takeoff/Landing Procedures

1. Place the aircraft in an open, flat area with the rear of the aircraft facing towards you.
2. Power on the remote controller and the aircraft.
3. Launch DJI Fly and enter the camera view.
4. Wait for the aircraft self-diagnostics to complete. If DJI Fly does not show any irregular warning, you can start the motors.
5. Push the throttle stick up slowly to take off.
6. To land, hover over a level surface and gently push the throttle stick down to descend.
7. The motors will stop automatically after landing.
8. Power off the aircraft before the remote controller.

Video Suggestions and Tips

1. The pre-flight checklist is designed to help you fly safely and shoot videos during flight. Go through the full pre-flight checklist before each flight.
2. Select the desired gimbal operation mode in DJI Fly.
3. It is recommended to take photos or record videos when flying in Normal or Cine mode.
4. DO NOT fly in bad weather such as on rainy or windy days.
5. Choose the camera settings that best suit your needs.
6. Perform flight tests to establish flight routes and preview scenes.
7. Push the control sticks gently to ensure smooth and stable movement of the aircraft.



- Make sure to place the aircraft on a flat and steady surface before takeoff. DO NOT launch the aircraft from your palm or while holding it with your hand.
-

Appendix

Specifications

Aircraft	
	248.9 g The standard weight of the aircraft (including the DJI Mini 3 Pro Intelligent Flight Battery, propellers, and a microSD card). Actual product weight may vary due to differences in batch materials and external factors. Registration is not required in some countries and regions. Check local rules and regulations before use.
Takeoff Weight	With the DJI Mini 3 Pro Intelligent Flight Battery Plus, the aircraft will weigh more than 249 g (about 290 g). Please check and strictly abide by local laws and regulations before flying.
Dimensions (L×W×H)	Folded (without propellers): 148×90×62 mm Unfolded (with propellers): 251×362×72 mm
Diagonal Distance	247 mm
Max Ascent Speed	S Mode: 5 m/s N Mode: 3 m/s C Mode: 2 m/s
Max Descent Speed	S Mode: 3.5 m/s N Mode: 3 m/s C Mode: 1.5 m/s
Max Horizontal Speed (near sea level, no wind)	S Mode: 16 m/s N Mode: 10 m/s C Mode: 6 m/s
Max Takeoff Altitude Above Sea Level	With Intelligent Flight Battery: 4,000 m (13,123 ft) With Intelligent Flight Battery Plus: 3,000 m (9,843 ft) With Intelligent Flight Battery and propeller guard: 1,500 m (4,921 ft)
Max Flight Time	38 minutes (with Intelligent Flight Battery and a flight speed of 21.6 kph in windless condition) 51 minutes (with Intelligent Flight Battery Plus and a flight speed of 21.6 kph in windless condition)
Max Hovering Time	33 minutes (with Intelligent Flight Battery and in windless condition) 44 minutes (with Intelligent Flight Battery Plus and in windless condition)
Max Flight Distance	18 km (with Intelligent Flight Battery and measured while flying at 43.2 kph in windless conditions) 25 km (with Intelligent Flight Battery Plus and measured while flying at 43.2 kph in windless conditions)
Max Wind Speed Resistance	10.7 m/s
Max Tilt Angle	S Mode: 40° (flying forward); 35° (flying backward) N Mode: 25° C Mode: 25°

Max Angular Velocity	S Mode: 130°/s by default (the adjustable range on DJI Fly is 20-250°/s) N Mode: 75°/s by default (the adjustable range on DJI Fly is 20-120°/s) C Mode: 30°/s by default (the adjustable range on DJI Fly is 20-60°/s)
Operating Temperature	-10° to 40° C (14° to 104° F)
GNSS	GPS + GLONASS + GALILEO
Hovering Accuracy Range	Vertical: Vision Positioning: ±0.1 m; GNSS Positioning: ±0.5 m Horizontal: Vision Positioning: ±0.3 m; GNSS Positioning: ±1.5 m
Transmission	
Video Transmission System	O2
Operating Frequency	2.4000-2.4835 GHz, 5.725-5.850 GHz
Transmitter Power (EIRP)	2.4 GHz: <26 dBm (FCC), <20 dBm (CE/SRRC/MIC) 5.8 GHz: <26 dBm (FCC/SRRC), <14 dBm (CE)
Wi-Fi	
Protocol	802.11 a/b/g/n/ac
Operating Frequency	2.4000-2.4835 GHz, 5.725-5.850 GHz
Transmitter Power (EIRP)	2.4 GHz: <19 dBm (FCC/CE/SRRC/MIC) 5.8 GHz: <20 dBm(FCC/SRRC), <14 dBm(CE)
Bluetooth	
Protocol	Bluetooth 5.2
Operating Frequency	2.4000-2.4835 GHz
Transmitter Power (EIRP)	<8 dBm
Gimbal	
Mechanical Range	Tilt: -135° to +80° Roll: -135° to +45° Pan: -30° to +30°
Controllable Range	Tilt: -90° to +60° Roll: 0° or -90° (Landscape or Portrait)
Stabilization	3-axis (tilt, roll, pan)
Max Control Speed (tilt)	100°/s
Angular Vibration Range	±0.01°
Sensing System	
Downward Vision System	Precision Hovering Range: 0.5 m to 10 m
Operating Environment	Non-reflective, discursive surfaces with diffuse reflectivity of >20%, and adequate illuminance of >15 lux
Camera	
Image Sensor	1/1.3" CMOS, Effective Pixels: 12 MP
Lens	FOV: 82.1°
	Format Equivalent: 24 mm
	Aperture: f/1.7
ISO	Shooting Range: 1 m to ∞
	Video: 100-3200 Photo: 100-3200

Electronic Shutter Speed	1/8000-2 s
Max Image Size	4000 × 3000
Still Photography Modes and Parameters	Single: 12MP Interval: 12MP 2/3/5/7/10/15/20/30/60 s (JPEG) 5/7/10/15/20/30/60 s (JPEG+RAW) Automatic Exposure Bracketing (AEB): 12MP, 3 bracketed frames at 0.7 EV Step Pano: Sphere, 180°, Wide-angle HDR Mode: HDR supported in Single Shot mode
Photo Format	JPEG/DNG (RAW)
Video Resolution	4K: 3840×2160@24/25/30 fps 2.7K: 2720×1530@24/25/30/48/50/60 fps FHD: 1920×1080@24/25/30/48/50/60 fps HDR Mode: HDR supported when shooting at 24/25/30 fps
Video Format	MP4 (H.264)
Max Video Bitrate	100 Mbps
Supported File System	FAT32 (≤32 GB) exFAT (>32 GB)
Digital Zoom	4K: 2x 2.7K: 3x FHD: 4x
DJI RC-N1 Remote Controller	
Transmission	
Video Transmission System	When used with different aircraft hardware configurations, the DJI RC-N1 Remote Controller will automatically select the corresponding firmware version for updating. It supports the O2 transmission technology when linked with DJI Mini 3.
Live View Quality	720p/30fps
Operating Frequency	2.4000-2.4835 GHz, 5.725-5.850 GHz
Transmitter Power (EIRP)	2.4 GHz: <26 dBm (FCC), <20 dBm (CE/SRRC/MIC) 5.8 GHz: <26 dBm (FCC), <23 dBm (SRRC), <14 dBm (CE) 10 km (FCC), 6 km (CE/SRRC/MIC)
Max Transmission Distance (unobstructed, free of interference)	Data is tested under different standards in open areas free of interference. It only refers to the maximum, one-way flight distance without considering Return to Home. Please pay attention to RTH prompts in the DJI Fly app during actual flight.
Transmission Distance (in common scenarios, under FCC standard)	Strong interference (e.g., city center): approx. 1.5-3 km Moderate interference (e.g., suburbs, small towns): approx. 3-6 km No interference (e.g., rural areas, beaches): approx. 6-10 km Data is tested under FCC standard in open areas and with different levels of interference. The data is for reference only. Pay attention to RTH prompts in the DJI Fly app during actual flight.

General	
Operating Temperature	-10° to 40° C (14° to 104° F)
Battery Capacity	5,200 mAh
Battery Type	Li-ion
Chemical System	LiNiMnCoO2
Operating Current/Voltage	1200 mA@3.6 V (with Android device) 700 mA@3.6 V (with iOS device)
Supported Mobile Device Size	180×86×10 mm (Height×Width×Thickness)
Supported USB Port Types	Lightning, Micro USB (Type-B), USB-C
Max Battery Life	6 hours (without charging any mobile device) 4 hours (when charging a mobile device)
DJI RC Remote Controller	
Transmission	
Video Transmission System	When used with different aircraft hardware configurations, the DJI RC Remote Controller will automatically select the corresponding firmware version for updating. It supports the O2 transmission technology when linked with DJI Mini 3.
Operating Frequency	2.4000-2.4835 GHz, 5.725-5.850 GHz
Transmitter Power (EIRP)	2.4 GHz: <26 dBm (FCC), <20 dBm (CE/SRRC/MIC) 5.8 GHz: <26 dBm (FCC), <23 dBm (SRRC), <14 dBm (CE)
Max Transmission Distance (unobstructed, free of interference)	10 km (FCC), 6 km (CE/SRRC/MIC) Data is tested under different standards in open areas free of interference. It only refers to the maximum, one-way flight distance without considering Return to Home. Please pay attention to RTH prompts in the DJI Fly app during actual flight.
Transmission Distance (in common scenarios, under FCC standard)	Strong interference (e.g., city center): 1.5-3 km Moderate interference (e.g., suburbs, small towns): 3-6 km No interference (e.g., rural areas, beaches): 6-10 km Data is tested under FCC standard in open areas and with different levels of interference. The data is for reference only. Please pay attention to RTH prompts in the DJI Fly app during actual flight.
Wi-Fi	
Protocol	802.11a/b/g/n
Operating Frequency	2.4000-2.4835 GHz; 5.150-5.250 GHz; 5.725-5.850 GHz
Transmitter Power (EIRP)	2.4 GHz: <23 dBm (FCC); <20 dBm (CE/SRRC/MIC) 5.1 GHz: <23 dBm (FCC/CE/SRRC/MIC) 5.8 GHz: <23 dBm (FCC/SRRC), <14 dBm (CE)
Bluetooth	
Protocol	Bluetooth 4.2
Operating Frequency	2.4000-2.4835 GHz
Transmitter Power (EIRP)	<10 dBm

General	
Operating Temperature	-10° to 40° C (14° to 104° F)
GNSS	GPS + BEIDOU + GALILEO
Battery Capacity	5,200 mAh
Battery Type	Li-ion
Chemical System	LiNiMnCoO2
Operating Current/Voltage	1250 mA@3.6 V
Max Battery Life	Approx. 4 hours
Storage Capacity	microSD card supported
Supported microSD Cards for DJI RC remote controller	UHS-I Speed Grade 3 rating microSD card
Recommended microSD Cards for DJI RC remote controller	SanDisk Extreme 64GB V30 A1 microSDXC SanDisk Extreme 128GB V30 A2 microSDXC SanDisk Extreme 256GB V30 A2 microSDXC SanDisk Extreme 512GB V30 A2 microSDXC SanDisk Extreme Pro 64GB V30 A2 microSDXC SanDisk Extreme Pro 256GB V30 A2 microSDXC SanDisk Extreme Pro 400GB V30 A2 microSDXC SanDisk High Endurance 64GB V30 microSDXC SanDisk High Endurance 256GB V30 microSDXC Kingston Canvas Go!Plus 64GB V30 A2 microSDXC Kingston Canvas Go!Plus 256GB V30 A2 microSDXC Lexar High Endurance 64GB V30 microSDXC Lexar High Endurance 128GB V30 microSDXC Lexar 633x 256GB V30 A1 microSDXC Lexar 1066x 64GB V30 A2 microSDXC Samsung EVO Plus 512GB microSDXC
Intelligent Flight Battery	
Battery Capacity	2453 mAh
Standard Voltage	7.38 V
Max Charging Voltage	8.5 V
Battery Type	Li-ion
Chemical System	LiNiMnCoO2
Energy	18.10 Wh
Weight	Approx. 80.5 g
Charging Temperature	5° to 40° C (41° to 104° F)
Charging Time	64 minutes (with the DJI 30W USB-C Charger and the battery mounted to the aircraft) 56 minutes (with the DJI 30W USB-C Charger and the battery inserted into the DJI Mini 3 Pro Two-Way Charging Hub)
Recommended Charger	DJI 30W USB-C Charger or other USB Power Delivery chargers (30 W) When you charge the battery mounted to the aircraft or inserted into the DJI Mini 3 Pro Two-Way Charging Hub, the maximum charging power supported is 30 W.

Intelligent Flight Battery Plus	
Battery Capacity	3850 mAh
Standard Voltage	7.38 V
Max Charging Voltage	8.5 V
Battery Type	Li-ion
Chemical System	LiNiMnCoO ₂
Energy	28.4 Wh
Weight	Approx. 121 g
Charging Temperature	5° to 40° C (41° to 104° F)
Charging Time	101 minutes (with the DJI 30W USB-C Charger and the battery mounted to the aircraft)
	78 minutes (with the DJI 30W USB-C Charger and the battery inserted into the DJI Mini 3 Pro Two-Way Charging Hub)
Recommended Charger	DJI 30W USB-C Charger or other USB Power Delivery chargers (30 W)
	When you charge the battery mounted to the aircraft or inserted into the DJI Mini 3 Pro Two-Way Charging Hub, the maximum charging power supported is 30 W.

Two-Way Charging Hub	
Input	USB-C: 5V = 3A, 9V = 3A, 12V = 3A
Output	USB: 5V = 2A
Rated Power	30 W
Charging Type	Charge three batteries in sequence
Charging Temperature	5° to 40° C (41° to 104° F)
Supported Batteries	DJI Mini 3 Pro Intelligent Flight Battery (BWX162-2453-7.38) DJI Mini 3 Pro Intelligent Flight Battery Plus (BWX162-3850-7.38)

App	
Name	DJI Fly
Required Operating System	iOS v11.0 or later; Android v6.0 or later

Storage	
Supported microSD Cards for aircraft	UHS-I Speed Grade 3 rating microSD card
Recommended microSD Cards for aircraft	SanDisk Extreme 32GB V30 A1 microSDXC
	SanDisk Extreme 64GB V30 A1 microSDXC
	SanDisk Extreme 128GB V30 A2 microSDXC
	SanDisk Extreme 256GB V30 A2 microSDXC
	SanDisk Extreme Pro 32GB V30 A1 microSDXC
	Kingston Canvas Go!Plus 64GB V30 A2 microSDXC
	Kingston Canvas Go!Plus 256GB V30 A2 microSDXC
	Kingston Canvas React Plus 64GB V30 A1 microSDXC
	Kingston Canvas React Plus 128GB V30 A1 microSDXC
Samsung Pro Plus 256GB V30 A2 microSDXC	



- Different shooting modes may support different ISO ranges. See the actual adjustable ISO range for different shooting modes in DJI Fly.
 - The photos taken in Single Shot mode have no HDR effect in the following situations:
 - a) When the aircraft is in motion or stability is affected due to high wind speeds;
 - b) When white balance is set to manual mode;
 - c) The camera is in Auto mode and the EV setting is adjusted manually;
 - d) The camera is in Auto mode and the AE lock is turned on;
 - e) The camera is in Pro mode.
-

Firmware Update

Use DJI Fly or DJI Assistant 2 (Consumer Drones Series) to update the aircraft and the remote controller firmware.

Using DJI Fly

When connecting the aircraft or remote controller to DJI Fly, you will be notified if a new firmware update is available. To start updating, connect your remote controller or mobile device to the internet and follow the on-screen instructions. Note that you cannot update the firmware if the remote controller is not linked to the aircraft. An internet connection is required.

Using DJI Assistant 2 (Consumer Drones Series)

Update the aircraft and remote controller firmware separately using DJI Assistant 2 (Consumer Drones Series).

Follow the instructions below to update the aircraft firmware:

1. Launch DJI Assistant 2 (Consumer Drones Series) on your computer and log in with your DJI account.
2. Power on the aircraft and connect the aircraft to the computer via the USB-C port within 20 seconds.
3. Select DJI Mini 3 and click Firmware Updates.
4. Select the firmware version.
5. Wait for the firmware to download. The firmware update will start automatically.
6. Wait for the firmware update to complete.

Follow the instructions below to update the remote controller firmware:

1. Launch DJI Assistant 2 (Consumer Drones Series) on your computer and log in with your DJI account.
2. Power on the remote controller and connect it to the computer via the USB-C port.
3. Select the corresponding remote controller and click Firmware Updates.
4. Select the firmware version.
5. Wait for the firmware to download. The firmware update will start automatically.
6. Wait for the firmware update to complete.



- Make sure to follow all the steps to update the firmware, otherwise the update may fail.
 - The firmware update will take approximately 10 minutes. It is normal for the gimbal to go limp, aircraft status indicators to blink, and the aircraft to reboot. Wait patiently until the update is complete.
 - Make sure the computer is connected to the internet during the update.
 - Before performing an update, make sure both the aircraft and the remote controller have at least 20% power.
 - Do not unplug the USB-C cable during an update.
-

Aftersales Information

Visit <https://www.dji.com/support> to learn more about aftersales service policies, repair services, and support.



Contact
DJI SUPPORT

<https://www.dji.com/support>

This content is subject to change.

Download the latest version from
<http://www.dji.com/mini-3>

If you have any questions about this document, please contact
DJI by sending a message to DocSupport@dji.com.

dji is a trademark of DJI.

Copyright © 2022 DJI All Rights Reserved.