

FOX

TM



SUPER PNP
Instruction Manual

PREMIER
aircraft™

ATTENTION

BEFORE CONTINUING WITH THIS INSTRUCTION MANUAL OR ASSEMBLY OF FLEXJET, PLEASE VISIT OUR WIKI SUPPORT SITE FOR THE LATEST PRODUCT UPDATES, FEATURE CHANGES, MANUAL ADDENDUMS AND FIRMWARE CHANGES FOR BOTH YOUR FLEXJET AND THE INSTALLED AURA 8 ADVANCED FLIGHT CONTROL SYSTEM.

<http://wiki.flexinnovations.com/wiki/FlexJet>
<http://wiki.flexinnovations.com/wiki/Aura>

TABLE OF CONTENTS

Introduction	2	Wing Installation	12
Box Contents	2	Battery Installation	13
Specifications	3	Vertical Stabilizer Installation	13, 14
Replacement Parts	3	EDF Access Hatch, Tail Pipe, Exhaust Nozzle Re-installation	15
Optional Accessories	3	Ventral Fin Installation	16
Completion Items	3	Missile Rail Installation	16
Battery Charging Guidelines	4	Transmitter Control Test	17
Special Language Definitions	4	Flight Control Sensor Test	18
Important Information Regarding Warranty	4	Center of Gravity	19
Safety Warnings and Precautions	4	Pre-Flight Checks	19
Low Voltage Cutoff	4	Flying your FlexJet	20
Transmitter Setup	5	Advanced FlexJet Aura Configuration	21
Aura 8 AFCS	5	Expert Flight Mode Control Sensing Test	22
Receiver Installation/Servo Connections	6, 7	Airframe Repairs	23
Receiver installation/Aura Setup Note	8	Replacing Servos	23
Connecting a Battery/Arming ESC	8	Servicing the Power System	24
Retracts/Gear Sequencer Operation	9	Aircraft Troubleshooting Guide	25
EDF Access Hatch, Tail Pipe, Exhaust Nozzle Removal....	9	Limited Warranty	26
Flying Stabilizer Installation	10, 11	AMA Safety Code	27

INTRODUCTION

On behalf of the entire Flex Innovations Team, thank you for purchasing the Premier Aircraft FlexJet!

The FlexJet combines modern aerodynamics with sport jet practicality and performance. Speed is impressive and maneuvers can be very large! The FlexJet carries energy extremely well and offers a turbine-like experience.

Trailing link landing gear, and the wing's wide angle of attack range, along with Aura 8 make takeoffs and landings easy. Aerobatics are effortless and impressive. The FlexJet excels at knife edge and rolling maneuvers, large vertical maneuvers, and high alpha maneuvers such as square loops.

For the latest updates, features, addendums and more, before assembly, please visit:

<http://wiki.flexinnovations.com/wiki/flexjet>

- Custom-tuned Aura 8 gyro stabilization system provides the ultimate in stability and control
- Powerful 60-sized out-runner motor provides efficient power
- 11-bladed 90mm fan for great thrust and sound
- Electric retracts with metal pivot
- All metal trail link struts with rubber down-stops
- Electric gear doors with sequencer installed
- Embedded carbon fiber spars in wings and stabilizer
- Custom-designed control horns to optimize control geometry and performance
- High-precision digital servos with metal gears
- Lightweight EPO foam is stiff and tough

BOX CONTENTS

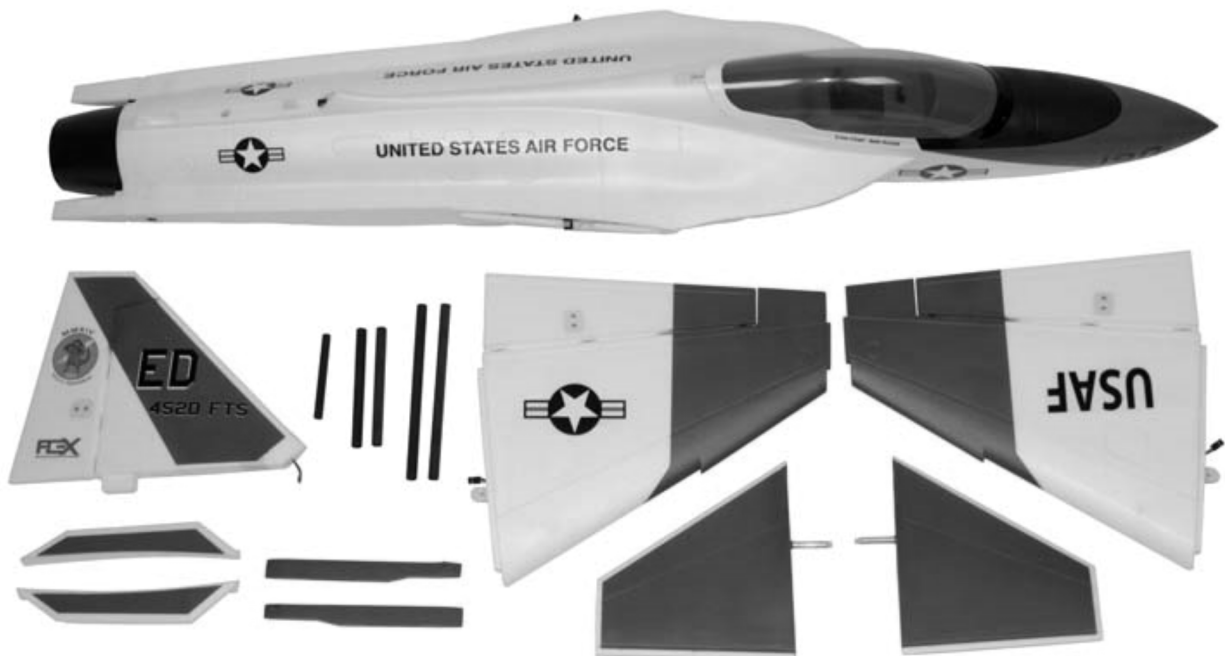

SPECIFICATIONS

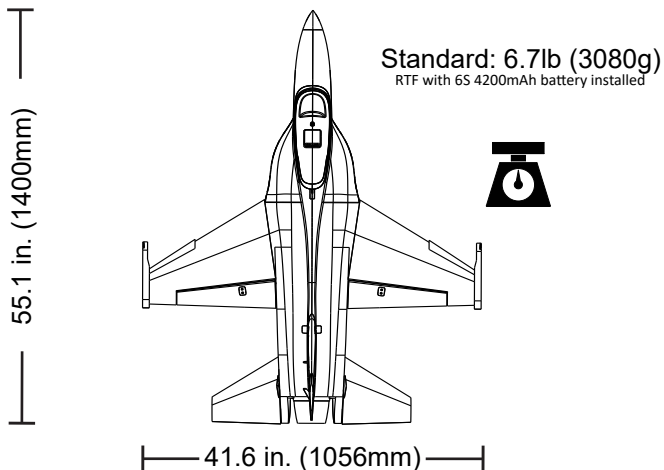

REPLACEMENT PARTS

FPM347001	Fuselage (No Hatches) Orange
FPM347002	Fuselage (No Hatches) Blue
FPM347003	L+R Wing Set Orange
FPM347004	L+R Wing Set Blue
FPM347005	L+R Stab and Fin Set Orange
FPM347006	L+R Stab and Fin Set Blue
FPM347007	Canopy and Fan Hatch Set Orange
FPM347008	Canopy and Fan Hatch Set Blue
FPM347009	Ventral Fin and Missile Rail Set Orange
FPM347010	Ventral Fin and Missile Rail Set Blue
FPM347011	Wing + Fin Carbon Fiber Tube Set
FPM347012	Orange Decal Set
FPM347013	Blue Decal Set
FPM347014	Orange Nose Cone, Exhaust Nozzle, Exhaust Tube Set
FPM347015	Pushrod Set
FPM347016	Hardware Package
FPM347017	Landing Gear Struts
FPM347018	Landing Gear Rubber Strut Downstop Set
FPM347019	Wheel Set
FPM347020	Doors, Hinges, Misc. Plastic Parts
FPM347021	Blue Nose Cone, Exhaust Nozzle, Exhaust Tube Set
FPMA0004	Metal Clevis Set (4)
FPMDF90A	90mm EDF Fan Assembly (No Motor)
FPZM1060DFA	Potenza 60 DF 1450Kv BL Motor
FPZM1060DFA1	Potenza 60 DF 1450Kv BL Motor Shaft
FPZA1020	Potenza 3-Piece Retract Set
FPZEDFW80BEC	Potenza Gear/Door sequencer
FPZEDFH	Hobbywing 80A w/EXT. 5V/8A BEC EDF Ver.
FPZDS15B	Potenza DS15 MG Digital Servo w/165mm
FPZDS12	Potenza DS12 MG Sub-Micro Servo

OPTIONAL ACCESSORIES

FPZAU01	Potenza 3pc. Male-Male Servo Connectors
FPZB52006S40	Potenza 6S 5200mAh 40C Li-Po
FPZB42006S40	Potenza 6S 4200mAh 40C Li-Po
FPZC0080	Potenza C-80 80W Multi Chemistry Charger
FTVHWBQ2006	Hobbywing ESC Programming Card
FPZA1010	Potenza Digital Battery Analyzer
SPMAR8010T	Spektrum AR8010T DSMX Receiver (Recommended Spektrum Receiver)
SPM9645	Spektrum DSMX Remote Receiver
FPZA1012	Potenza Servo Y-Harness (QTY:2 needed for PWM connections)

COMPLETION ITEMS

INSTALLED!		Aura 8 Advanced Flight Control System (FPZAURA08ZZFJ1)
INSTALLED!		Potenza 60-DF BL 1450 Kv Brushless Outrunner Motor (FPZM1060DFA)
INSTALLED!		Potenza DS15 Digital Servos (FPZDS15B)
INSTALLED!		Potenza DS12 Digital Servos (FPZDS12)
INSTALLED!		HobbyWing SkyWalker 80A ESC with 5V/8A External BEC (FPZEDFW80BEC)
INSTALLED!		90mm EDF Fan Assembly (FPMDF90A)
NEEDED TO COMPLETE		4000-5200mAh 6S 22.2V 40C+ Li-Po (6S 4200mAh: FPZB42006S40) (6S 5200mAh: FPZB52006S40)
NEEDED TO COMPLETE		DSM2/DSMX Remote Receivers (2), SRXL, Futaba or Hitec S.Bus, Graupner HOTT, JR XBus, Jeti UDI, 6+ Channel Receiver (any brand)
NEEDED TO COMPLETE		6+ Channel Computer Transmitter

BATTERY CHARGING GUIDELINES

⚠ WARNING

FOLLOW ALL INSTRUCTIONS PROVIDED BY YOUR BATTERY AND CHARGER MANUFACTURER. FAILURE TO COMPLY CAN RESULT IN FIRE.

The assembly of the FlexJet can be accomplished in 1-2 hours. Prior to assembling the airplane, it is advisable to charge your battery so that you are ready to begin setup upon completion of the assembly of your model.

We recommend the use of an advanced Li-Po balancing charger, such as our Potenza C80 Multi Chemistry Touch Screen AC/DC Balancing Charger (**FPZC0080**) to get the maximum performance and lifespan out of your batteries.

Our airplanes are designed around our Potenza LiPo batteries. We recommend the Potenza 6S 5200mAh 40C LiPo (**FPZB52006S40**), in the FlexJet based on our extensive testing and development. These batteries feature an EC5 connector, so no soldering is required for use in your FlexJet.

All are available at www.flexinnovations.com



SPECIAL LANGUAGE DEFINITIONS

The following terms are used throughout the product literature to indicate various levels of potential harm when operating this product:

- NOTICE:** Procedures, which if not properly followed, create a possibility of physical property damage AND a little or no possibility of injury.
- CAUTION:** Procedures, which if not properly followed, create the probability of physical property damage AND a possibility of serious injury.
- WARNING:** Procedures, which if not properly followed, create the probability of property damage, collateral damage, and serious injury OR create a high probability of serious injury.

WARNING

AGES 14+

This product is not intended for use by children under 14 years without direct adult supervision.

ATTENTION

Read the ENTIRE instruction manual to become familiar with the features of the product before operating. Failure to assemble or operate the product correctly can result in damage to the product, personal property, and cause serious or fatal injury.

All instructions, warranties and other collateral documents are subject to change at the sole discretion of Flex Innovations, LLC. For up-to-date product literature, please visit our website at www.flexinnovations.com and click on the FlexJet and Aura 8 product pages.

IMPORTANT INFORMATION REGARDING WARRANTY

Please read our Warranty and Liability Limitations section before building this product. If you as the Purchaser or user are not prepared to accept the liability associated with the use of this Product, you are advised to return this product immediately in new and unused condition to the place of purchase.

SAFETY WARNINGS AND PRECAUTIONS

Protect yourself and others by following these basic safety guidelines.

1. This manual contains instructions for safety, operation and maintenance. It is essential to read and follow all the instructions and warnings in the manual, prior to assembly, setup or use, in order to operate correctly and avoid damage or serious injury.
2. This model is not a toy, rather it is a sophisticated hobby product and must be operated with caution and common sense. This product requires some basic mechanical ability. Failure to operate this product in a safe and responsible manner could result in injury or damage to the product or other property.
3. This model must be assembled according to these instructions. Do not alter or modify the model outside of these instructions provided by Flex Innovations, LLC. as doing so may render it unsafe and/or unflyable. It is your responsibility to ensure the airworthiness of the model.
4. Inspect and check operation of the model and all its components before every flight.
5. If you are not an experienced pilot or have not flown a high-performance model before, it is recommended that you seek assistance from an experienced pilot in your R/C club for your first flights. If you're not a member of a club, the Academy of Model Aeronautics (AMA) has information about clubs in your area whose membership includes experienced pilots.
6. Keep area around airplane clear from such items as loose clothing, jewelry, long hair, or tools as they can become entangled in the fan unit. Keep your hands and body parts away from the fan unit as injury can occur.
7. Never fly in visible moisture, or submerge the airplane or any of its electronic components in water. Permanent damage to electronic components may occur, or corrosion of components may lead to intermittent failures.

LOW VOLTAGE CUTOFF

LiPo batteries have a nominal (rated) voltage of 3.7V per cell, and fully charged, reach 4.2V per cell. Batteries are designed to be discharged below the nominal voltage, however, if they are discharged below 3.0V per cell, damage will occur and the pack will lose capacity. For best long term battery life, set a timer and land after a time that leaves approximately 15% of the battery's capacity remaining.

Low voltage cutoff is a feature that is built into the Hobby Wing SkyWalker 80A ESC that is designed to protect the connected battery from being discharged too far and causing permanent damage to the cells. Circuitry within the ESC will automatically detect when the input voltage from the battery pack reaches below 3.15V per cell (average) and will remove power to the motor, but still deliver power to the servos so that a safe landing may be made. If the motor begins to lose power rapidly during flight, the LVC has sensed that the total voltage of the pack has dropped below 3.15V per cell average, and the airplane should be landed immediately.

⚠ WARNING

DO NOT ATTEMPT RADIO SETUP WITH MOTOR PLUGGED INTO ESC. INADVERTENT POWER-UP COULD CAUSE DEATH OR SERIOUS INJURY.

TRANSMITTER SETUP

Start with a **freshly reset new model memory** in your transmitter. **Make ONLY the changes shown in the Transmitter Configuration Guide.**

The Aura 8 installed in the FlexJet defaults to 3 flight modes that are switched via CH6/Aux 1 in your transmitter. You may need to reassign CH6/Aux 1 to a 3-position switch.

The retracts in the FlexJet are operated via CH5/Gear in your transmitter. You may need to reassign CH5/Gear to a 2-position switch.

Consult your transmitter manual if you have questions on how to change the switch or channel assignments.

The Aura comes pre-programmed with dual rates and expos specifically configured for the FlexJet. For large (greater than 5%) changes in expo or dual rates, it is highly recommended to reset all expos and rates to default in the transmitter, and tune through the Aura Config Tool.

The Aura Config Tool is free to download, and can be used on any Windows-based PC or tablet. Download at: <http://flexinnovations.com/AuraConfigTool>

More information for specific transmitter brands available here: http://wiki.flexinnovations.com/wiki/Aura#Aura_Tips

TRANSMITTER CONFIGURATION GUIDE

Wing Type	Normal - 1 Aileron, 1 Elevator, 1 Rudder (No Flaps)	
End Points (Travel EPA)	Aileron/Elevator/Rudder	125%¹
	Throttle, Gear (Ch.5), Aux 1 (Ch.6)	100%¹
Reversing	Ail/Ele/Rudder set to Normal Throttle depends on receiver connection type²	
Sub Trim	Verify at zero, sub-trim not allowed	
Trim Levers	Verify at zero	
CH. 5 (Gear)	Assigned to a 2-position switch (Retracts)	
CH. 6 (Aux1)	Assigned to a 3-position switch (Flight Modes)	
Timer	Set to 4:00 for initial flights with 5200mAh³	
	Set to 3:30 for initial flights with 4200mAh³	

1. Note: JR Mode B users set Throttle, Aileron, Elevator, Rudder and Gear travels to 88%.
2. Throttle direction depends on transmitter brand and receiver connection type. Leave at defaults to start, and reverse as needed.
3. The FlexJet can fly anywhere between 4 and 5+ minutes (w/6S 5200mAh Li-Po) depending on flying style and condition of flight battery.

AURA 8 AFCS

The Aura 8 advanced flight control system installed in your FlexJet is a giant leap forward in aircraft flight control system technology. Compatible with virtually every receiver on the market today, the Aura features special configuration for DSM systems via remote receiver connection(s), and serial data connection for Futaba or Hitec S.Bus, Spektrum SRXL, Graupner HOTT (Sum D of 8), JR XBus (Mode B), and Jeti UDI12 (standard) systems, as well as being compatible with traditional receivers via PWM servo connections.

The Aura 8 advanced flight control system in your FlexJet has been pre-tuned for ease of use, eliminating many hours of tedious setup. For the latest Aura features, programs, transmitter downloads, and instructions, please visit <http://wiki.flexinnovations.com/wiki/Aura>

The Aura is programmable through any Windows based PC or tablet. All dual rate, expo, travel, and assignable mode programs are adjusted inside the Aura through the PC application. An assignable master gain that is **OFF** by default can be enabled by the Aura application. If desired, assign CH 8/AUX 3 on a proportional dial or slider.

By default, **CH6/Aux1** is used to select the 3 flight modes by 3 position transmitter switch. **CH5/Gear** is used to retract/deploy the landing gear.

Description of Pre-Loaded Aura Flight Modes (FM)

Mode 1 (Gyro Off): Rates are set for general flight (same as Sport Mode). Exponential is tuned for comfortable flight.

Mode 2 (Sport Mode): Rates are set for general flight (same as Mode 1). Gains are moderate and tuned for comfortable feel/best performance for precision aerobatics. Expo is tuned for comfortable flight.

Mode 3 (High Rate Sport/Advanced Mode): Gains are highest and tuned for sport aerobatics. Rates are set to highest. Exponential is tuned for comfortable flight.

NOTE - Rudder stick movement will also move ailerons and elevator. This is NORMAL, due to pre-programmed mixing in the Aura 8 for knife-edge correction.

Each of the modes has been tuned by the Flex Team to offer a solid start. Because tastes in control feel are unique, if changes in rates and expo are needed, adjustments should be made through the **Aura 8, not in the transmitter**. Changes in gain value can only be made through the Aura or via *master gain* (if activated).

- Works conveniently with all major radio systems
- Accepts signals from DSM Remote Receiver(s), Spektrum SRXL, Futaba S.Bus, Graupner Hott (Sum D of 8), JR XBus (Mode B), Jeti UDI12 (standard), Hitec S.Bus, PPM Stream, or any brand of receiver via male to male servo connectors
- Expertly tuned and ready to use
- USB port allows loading model configurations, user programming, and firmware updates (cable included)
- Flexible and extensive programming through Windows-based PC or tablet
- 3+ flight modes allow precise or aggressive settings to be selected in flight
- 3-axis gyro utilized in FlexJet programming
- Powerful 32-bit processor and multi-axis sensor for future updates.

Visit wiki.flexinnovations.com/wiki/Aura for the latest Aura-related product information and tips for your particular radio brand.

REFERENCE ONLY: Aura Settings

		Mode 1	Mode 2	Mode 3
Aura 8 Rate Setup	Aileron	◀▶ 50%	◀▶ 55%	◀▶ 100%
	Elevator	▲ 45%	▲ 45%	▲ 100%
	Rudder	◀▶ 65%	◀▶ 70%	◀▶ 100%
		Mode 1	Mode 2	Mode 3
Aura 8 Expo Setup	Aileron	◀▶ 13%	◀▶ 12%	◀▶ 35%
	Elevator	▲ 15%	▲ 13%	▲ 25%
	Rudder	◀▶ 9%	◀▶ 8%	◀▶ 15%

The shown Aura 8 settings are pre-configured and the unit is ready to use. The chart shown is for informational purposes only. **DO NOT program these values into your transmitter.** No additional action is required to fly the airplane.

RECEIVER INSTALLATION/SERVO CONNECTIONS

Aura will auto-detect modern digital receiver connection(s). Using a modern digital receiver connection gives the Aura access to precise data of each channel for additional gyro-enabled outputs, simplifies wiring, and allows for more advanced features. To connect a modern digital receiver connection, follow the steps on this page, then skip ahead to the control direction test on **page 8**.

For traditional PWM receivers without digital connection(s), male to male servo leads must be used for each channel. Please refer to the "connecting a receiver via PWM connections section" on **page 7**.

Please note, regardless of connection type, If your radio system has a functioning throttle port, we recommend that you plug the ESC/BEC directly into the receiver (vs the Aura directly). This allows for the ESC to respond directly to the receiver's failsafe settings.

Supported Modern Data-Linked Receivers

Aura will auto-detect these modern digital receiver connections:

Spektrum Remote Receivers	Spektrum SRXL
Futaba or Hitec S.Bus	JR XBus (Mode B)
Graupner HOTT (Sum D of 8)	Jeti UDI12 (standard)*

A PPM (8CH, negative shift, approximately 22ms/frame) receiver may also be connected into Port 'B', however Aura will not auto-detect and setup must be performed through the Aura Config Tool (Windows Application).

DEFAULT AURA OUTPUT CONNECTIONS USING MODERN DIGITAL CONNECTION

S1	Throttle (ESC/BEC)
S2	Left Aileron
S3	Right Aileron
S4	Left Elevator
S5	Right Elevator
S6	Rudder
S7	Rudder (nose wheel)
S8	Ch5/Gear

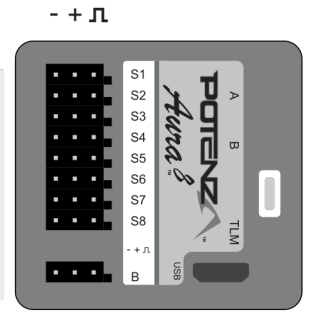

For specific information on receiver types and our recommended receivers for this aircraft, please visit the FlexJet Wiki page at the below URL:

<http://wiki.flexinnovations.com/wiki/FlexJet>

CONNECTING YOUR RECEIVER TO AURA

Digital Receiver Connections

1. While Spektrum and Futaba typically output their digital data stream by default, it may be necessary for JR DMSS, Graupner HOTT, and Jeti users to program the transmitter/receiver to output the correct digital format listed above. Consult your transmitter and receiver manuals for further details.
2. Bind your transmitter and receiver per your manufacturer's instructions.
3. Connect the included male to male extension to the receiver's digital stream port (ex: S.Bus, SRXL) and connect to servo port 'B' on the face of the Aura. Refer to your radio manufacturer's instructions for specific information on appropriate serial port connections and system settings.
4. With the transmitter powered, power up the aircraft. Aura will search (flashing/sweeping LEDs) and lock onto the receiver's signal. You will then see solid orange (power and calibrated sensor) plus solid green (valid radio source), and have control of the model.
5. Mount your receiver using double sided foam tape or hook and loop tape. Consult your receiver manual for proper mounting and antenna placement.

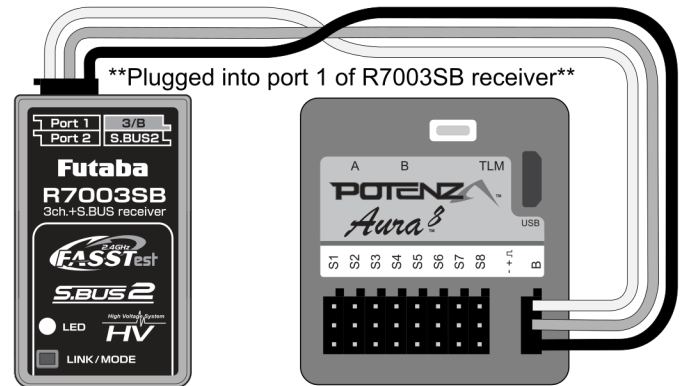

Please note, If you are using Futaba S.Bus be sure to use the S.Bus port in your receiver. Do NOT use the S.Bus2 port, as it is not currently supported for use with the Aura 8.

When using S.Bus, Aura reverses the throttle direction. It is therefore NOT necessary for Futaba S.Bus users to reverse the throttle IF the throttle/ESC is left plugged into the Aura.

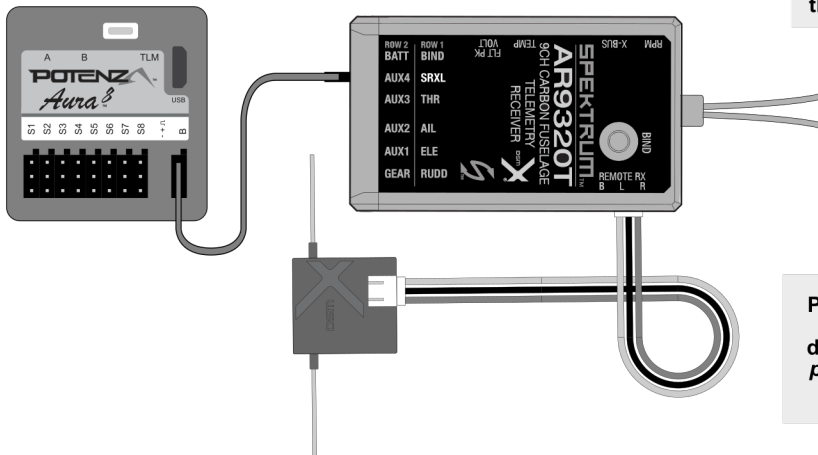

Please note, for optimum connection reliability and performance using Spektrum, the Flex Team highly recommends the use of the Spektrum AR8010T or AR9030T via SRXL.

If you are using a Spektrum SRXL receiver, be sure all remote receivers are plugged directly into the Spektrum receiver and not plugged into the Aura 8.

Please note, when using a modern digital receiver connection, the throttle source (ESC / throttle servo) should be plugged directly into the receiver and not plugged into the Aura 8 when possible. Please reference your radio manufacturer to verify if PWM ports are still active when using their data stream.

RECEIVER INSTALLATION/SERVO CONNECTIONS (CONTINUED)

Spektrum Remote Receivers

Please note, for optimum connection reliability and performance using Spektrum, the Flex Team highly recommends the use of a traditional receiver using SRXL. Remote receivers may still be used, however:

1. Connect (2) Spektrum Remote Receivers to Mini Port 'A' and Mini Port 'B' at the top of the Aura case.
- 2A. To bind a **DSMX** Spektrum Remote Receiver connection, insert a bind plug into Aura Port **S8**.
- 2B. To bind a **DSM2** Spektrum Remote Receiver connection, insert a bind plug into Aura port **S1 AND S8**.

If you are unsure which type of DSM remote receiver you have, start by attempting the bind process with a bind plug in S8. If you continue to have trouble binding, then insert one bind plug in S1, and one bind plug in S8.

3. Connect the flight battery to the ESC, and the remote receivers should begin to flash, indicating that they are ready to bind. Bind from here as recommended by your transmitter manufacturer.
4. Once bound (indicated by each remote receiver showing a solid orange LED), Aura will begin the Auto-Detect process, indicated by flashing/sweeping LEDs on the Aura. Once found, you will see solid orange (power and calibrated sensor) and solid green (valid receiver data) LEDs, indicating the Aura is in its flight-ready state.
5. Mount your receivers using double sided foam tape, or hook and loop tape. Consult your receiver manual for proper mounting orientations and procedures.

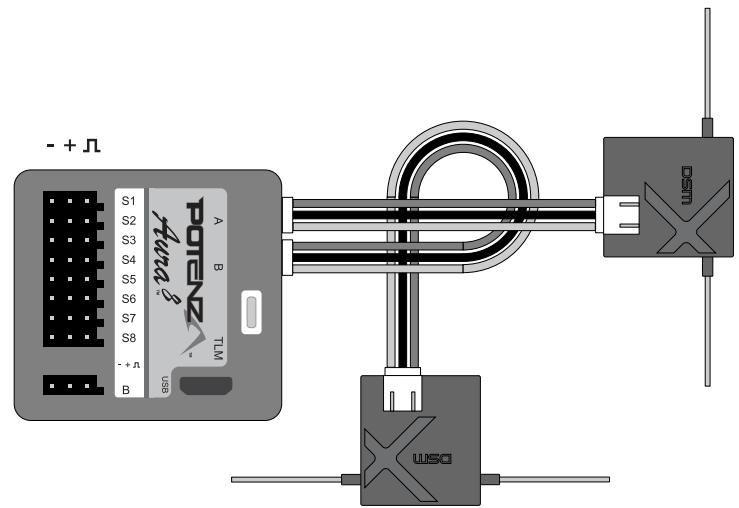

Note: It may be necessary to move the ESC lead to another open port (such as 'Port B') during the binding procedure. Be sure to return the ESC lead back to S1 after binding is complete.

Note: There are many JR-branded remote receivers that use Spektrum DSM2 and DSMX RF protocol. For these, follow the instructions as Spektrum remote receivers.

Connecting a Traditional Receiver to Aura with PWM Servo Connections

PWM is an acronym which stands for Pulse Width Modulation. A servo will move to a specific angle in a specific direction based on the width of the signal pulse it receives. Most transmitters output a total pulse width of 1.1-1.9ms, with the midpoint being 1.5ms. Lower pulse widths will move the servo to one side of neutral and higher pulse widths to the other side of neutral. In order to utilize this type of receiver connection with your FlexJet, male to male servo leads that connect the corresponding receiver ports to Aura 8 are required. A minimum 6-channel receiver is required to set up the FlexJet/Aura 8 with PWM servo connections. **Please purchase (1) FPZAU01 Aura 3-piece male to male servo cable/S.Bus and (2) FPZA1012 Servo Y-Harnesses to complete the PWM connection setup.**

1. Bind your receiver to your transmitter by following the instructions provided by your transmitter and receiver manufacturer. Verify that it is bound by connecting a spare servo to the receiver and verify that it responds to the appropriate input.
2. With the transmitter and receiver powered OFF, re-wire the Aura and connect to your receiver using the diagram below. Note that the throttle is plugged directly into the receiver.

NOTICE

VERIFY PROPER POLARITY OF ALL CABLE CONNECTIONS PRIOR TO ADDING POWER TO THE SYSTEM

All four (4) PWM male to male connections must be connected AND connected in the proper polarity from receiver outputs to Aura inputs for Aura to activate servo outputs. (Aileron - S1, Elevator - S2, Rudder - S3, Aux1/CH6 - S4)

3. With the motor unplugged from the ESC, and ALL connections made between Aura and the receiver (observing correct polarity), power on your transmitter and the airplane with the flight battery, ensuring that the airplane is kept stationary. After a few seconds, the LEDs on Aura will sweep back and forth as Aura searches for a valid control signal. Once found, Aura will emit solid orange, green, blue and red LEDs. After the source is found, **apply transmitter right rudder** to assist Aura with determining your radio type. A solid orange (Aura running), and solid green (Aura receiving valid signal from the receiver) LED is illuminated after which point control of the model is established. This is only required during initial setup.

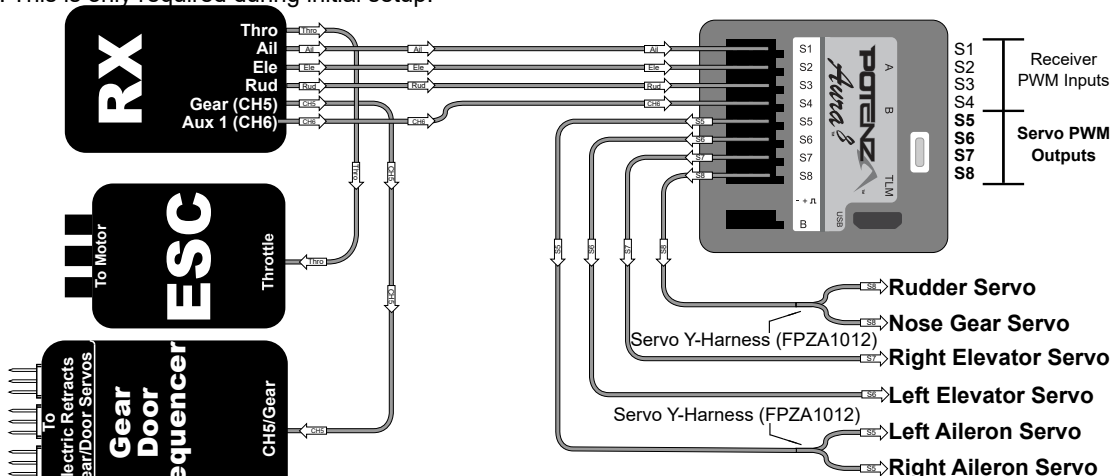

RECEIVER INSTALLATION / AURA 8 INSTALLATION NOTE

Throughout the manual we will ask you to power up the radio system. In order to assemble your FlexJet properly, It is critical that the receiver is bound to your transmitter and is communicating with Aura 8. **Please do not proceed until the Aura 8 emits a solid green LED (Aura received valid signal from receiver) and solid orange LED (Aura has power and calibrated sensor) when powered up.** In the event that you are having difficulties with radio or Aura 8 installation please see the following:

For issues with your transmitter and/or receiver, please review your transmitter/receiver manual or contact the manufacturer directly.

For issues regarding Aura 8 please reference the following:

- Wiki page: wiki.flexinnovations.com/wiki/Aura
- Email us at support@flexinnovations.com
- Contact Aura Support at 866-310-3539

CONNECTING A BATTERY/ARMING THE ESC

Observe the following procedures to safely power up your model after it has been bound.

1. Lower the throttle stick and trim to their lowest setting and turn on the transmitter. Wait for your transmitter to indicate the radio signal is being broadcast before proceeding.

If a battery is connected to the ESC with the throttle fully open on the active transmitter, the ESC will enter programming mode. If this occurs, simply disconnect the battery, lower the throttle, and reconnect the battery.

2. Ensure the aileron, elevator and rudder gimbals are centered.
3. With the airplane on a solid surface, connect the battery to the ESC and wait. The ESC will make the motor emit a series of audible tones during its initialization process.
4. The ESC will make the motor emit a short, final tone sequence indicating that the ESC is now armed, and the motor will spin in response to throttle stick movement.

⚠ WARNING

When making adjustments to linkages, transmitter settings or the Aura 8 flight control system, disengage motor by unplugging from ESC to guard against accidental spool up.

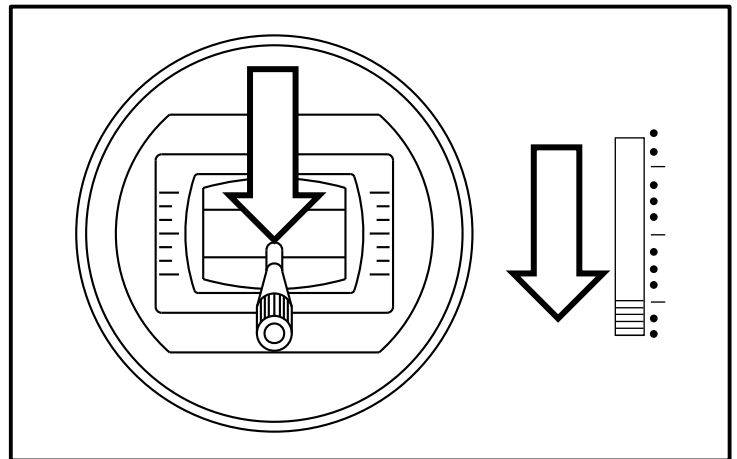

⚠ CAUTION

Always connect the battery when the throttle stick and throttle trim is in the idle/cut-off position.

⚠ WARNING

Hold the aircraft securely when connecting the battery before flight. Always ensure any and all objects are clear of the duct inlets and EDF fan unit as they may become entangled.

⚠ CAUTION

While assembling the FlexJet, ensure motor is disengaged by unplugging all wire leads that connect the ESC to the motor.

RETRACTS AND GEAR SEQUENCER OPERATION

The following steps will be required each time the aircraft is powered for flight:

1. Ensure your radio has Ch5/gear assigned to a 2-position switch.
2. Hold the FlexJet in a manner that the gear doors and retracts are unobstructed and free to close and open.
3. Cycle your transmitters Ch5/Gear switch **from down to up, then down again waiting about 1 second in each position.** The gear sequencer is now armed and the gear will deploy or retract.
4. Test the retracts. Ensure the gear/doors open and close without binding. When satisfied with the result, power off the aircraft.

Please note, Ch5/Gear can be reversed in the transmitter for user preference.



EDF ACCESS HATCH, TAIL PIPE, and EXHAUST NOZZLE REMOVAL

Required Tools and Fasteners: #1 Phillips Screwdriver
#11 Hobby Knife

1. Remove the two M3x10 Phillips washer head self-tapping screws that secure the EDF access hatch to the fuselage. Remove the EDF access hatch and place the hatch and screws in a secure location to be used at a later step in the assembly process.
2. Remove the two M3x25 Phillips self-tapping screws that secure the exhaust nozzle to the fuselage. Remove the exhaust nozzle and place the nozzle and screws in a secure location to be used at a later step in the assembly process.
3. Using a #11 hobby knife, cut the piece of tape that secures the thrust tube to the EDF fan housing and remove the tape from the ducted fan housing and thrust tube. **Be careful to only cut the tape. Do not cut through the thrust tube.**
4. Slide the tail pipe rearward until it is no longer connected to the ducted fan housing.
5. Carefully collapse the tail pipe (without creasing) and slide the tail pipe out the rear of the fuselage.

Please note, a video of the EDF access hatch, tail pipe, and exhaust nozzle installation/reinstallation is available at <http://wiki.flexinnovations.com/wiki/FlexJet>.

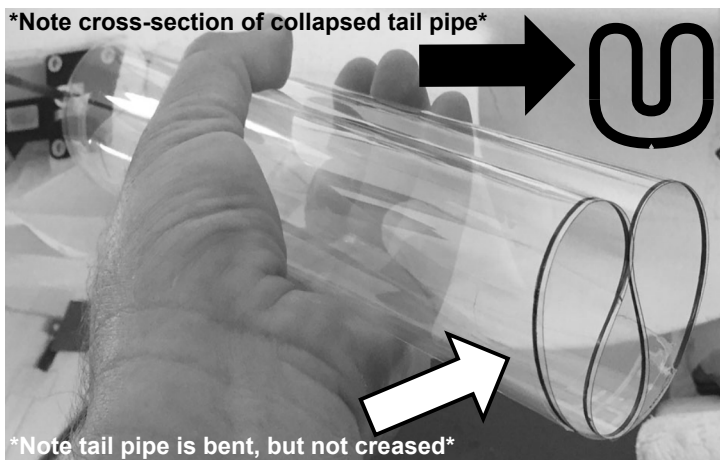
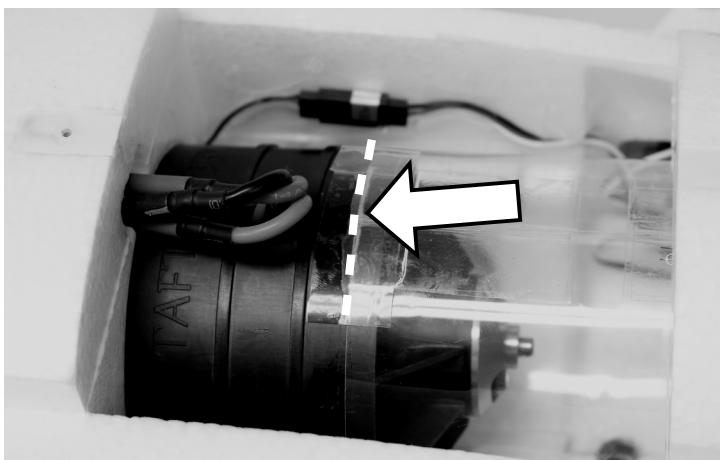
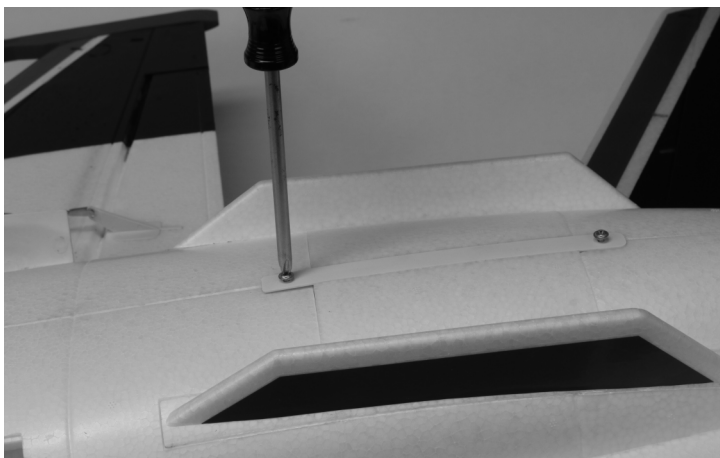

Note cross-section of collapsed tail pipe

Note tail pipe is bent, but not creased

FLYING STABILIZER INSTALLATION

Required Tools and Fasteners:



#1 Phillips Screwdriver, 2mm Hex Driver
Blue Thread Locker, Low-Tack Masking Tape
(2) M3x10mm Phillips Machine Thread Screw (*pre-installed*)
(2) M2 x 6mm Cap Head Self-Tapping Screws

To reduce the assembly time of your FlexJet, the stabilizer tubes have been installed at the factory.

1. Confirm that (1) M3x10mm Phillips head machine screw is securely fastened to each stabilizer tube. **Do not overtighten.**
2. Power on the radio system. Ensure the elevator servo arm is installed on the correct spline. The servo arm should be perpendicular relative to the servo case and pointing toward the bottom of the fuselage.
3. Cut out the **elevator trim gauges** located on the rear cover of the manual. Align the center-line of the elevator trim gauge with the panel line just forward of the flying stabilizers. Tape the elevator trim gauges onto the fuselage using low-tack masking tape.
4. Power on the transmitter and aircraft, once powered, insert a stabilizer into the fuselage.

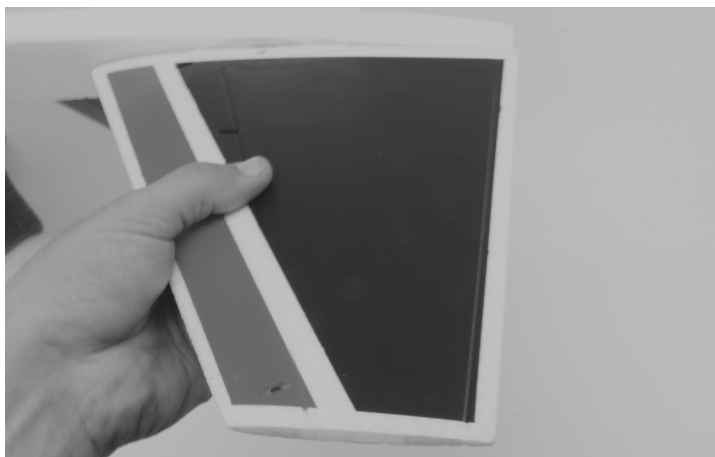
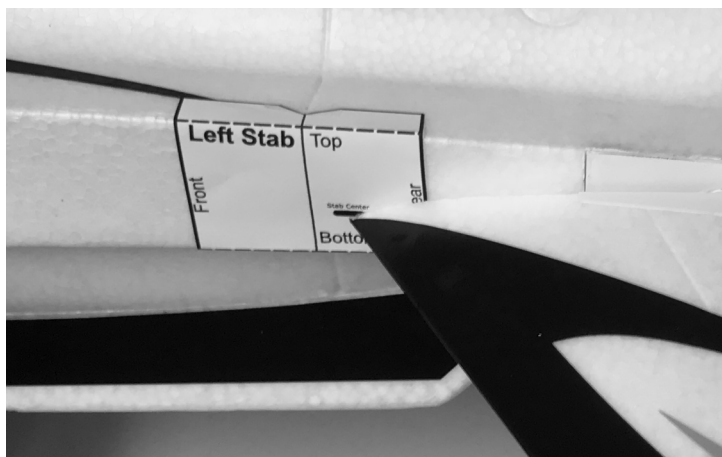
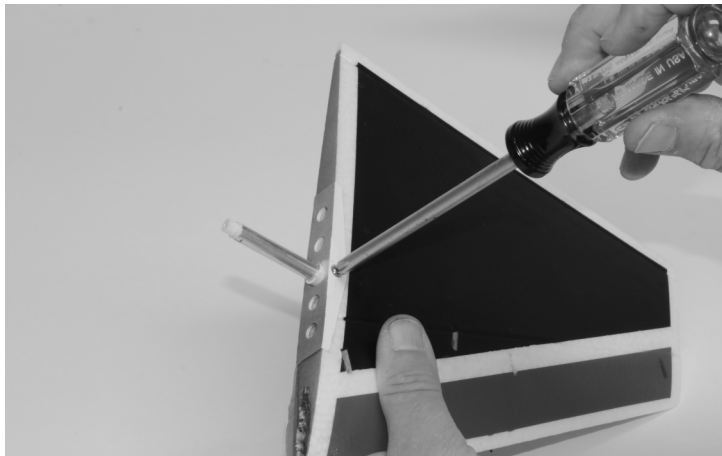

FLYING STABILIZER INSTALLATION (Continued)

5. Verify the transmitter elevator stick is set to neutral and trim is centered. Test fit the stab linkage arm onto the spline of the stab tube. The linkage arm should be parallel relative to the servo arm and pointing towards the bottom of the fuselage. Check the leading edge of the stabilizer relative to the elevator trim gauge. Remove the stab linkage arm and turn the clevis as necessary to center the stabilizer. **Please note, the stabilizer will hold a small amount of up elevator as indicated by the elevator trim gauge.**
6. Once satisfied with the mechanical trim of the stabilizer, use the included 2mm hex driver to secure the M2 x 6mm cap head self-tapping screw through the linkage arm and into the spline of the stab tube. **Be sure to avoid over-tightening the screw, do NOT use blue thread locker on this connection.**
7. Apply a drop of blue thread locker at the point where the clevis and control linkage meets.
8. Repeat steps 4-7 for the other stabilizer **ensuring the stab angle is the same for both left and right stabilizers before proceeding.**

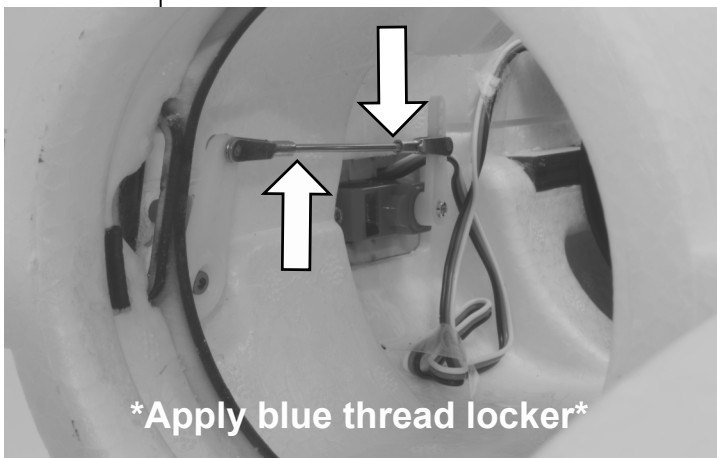
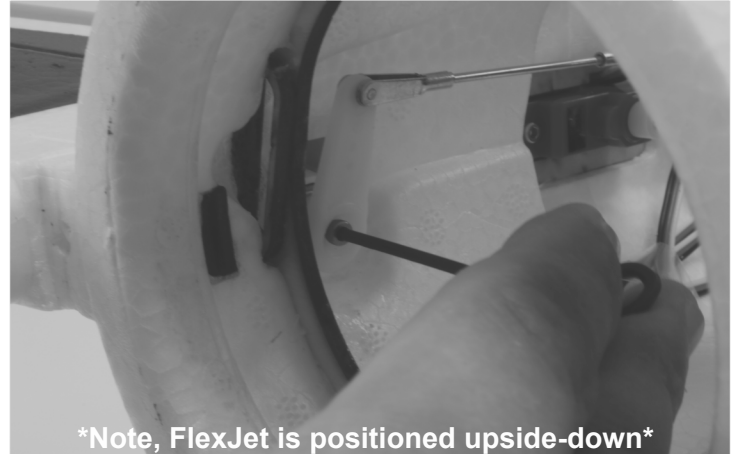
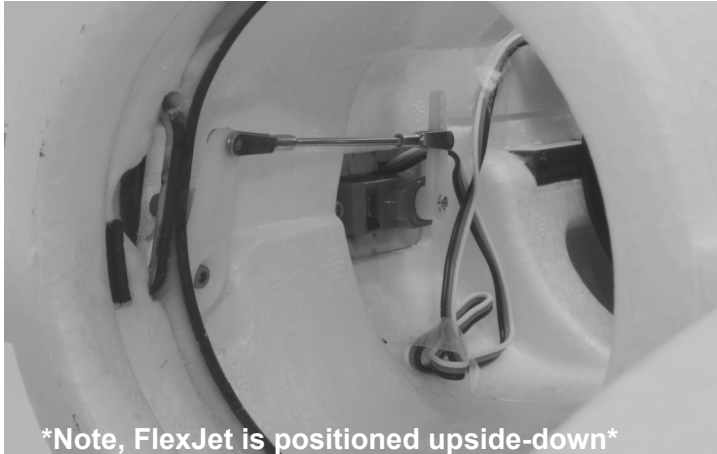

Wing Installation

Required Tools and Fasteners:



#1 Phillips Screwdriver
Blue Thread Locker
(2) M3x10 Phillips Head Self-Tapping Screws

1. Locate the four carbon fiber wing tubes. Insert a **short** tube into each wing panel **near the leading edge** and a **long** tube into each wing panel **near the trailing edge of the wing**.
2. Orient the servos toward the bottom of the fuselage and slide the left and right wing panels half-way onto the fuselage.
3. Connect the aileron servo lead to its respective extension in the fuselage.
4. Fully seat the wing panels into the fuselage, while being careful to align the wing mounting tab with the slot in the fuselage. Be sure to avoid pinching wires during this process.
5. Using a #1 phillips screwdriver, secure each wing panel to the fuselage with a M3x10 phillips head self-tapping screw. **Avoid over-tightening the screw, and do NOT use blue thread locker on this connection.**
6. Power on the radio system. Check the aileron trim by comparing the trailing edge of the aileron relative to the trailing edge of the wing.
7. If adjustment is needed, remove the clevis from the control horn, and turn the clevis. Re-attach the clevis to the control horn and inspect the mechanical trim of the aileron. Repeat this step until the aileron is flush with the trailing edge of the wing.
8. Once satisfied with the mechanical trim of the aileron, **apply a drop of blue thread locker at the point where the clevis and control linkage meet.**

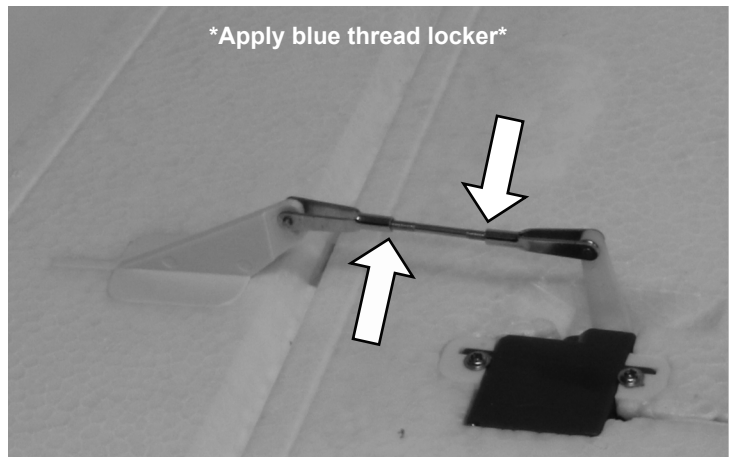
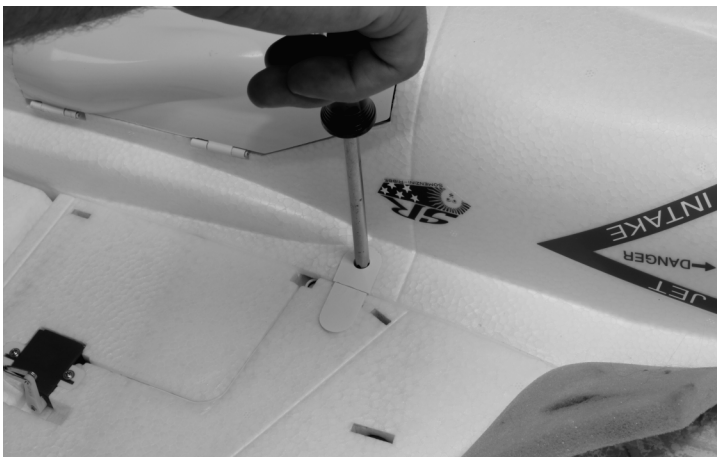
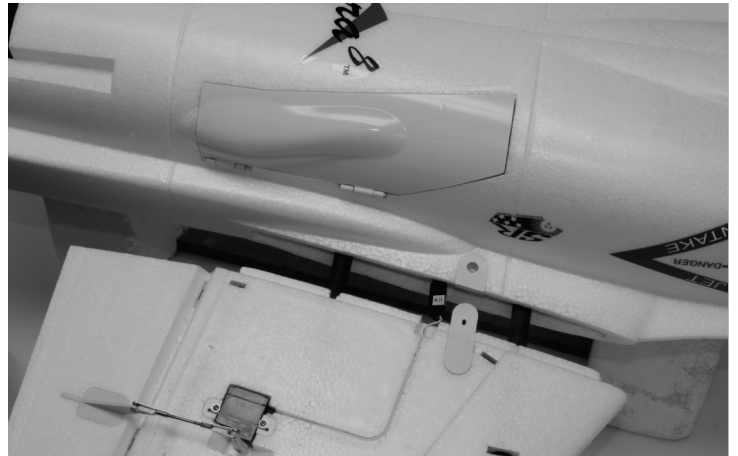
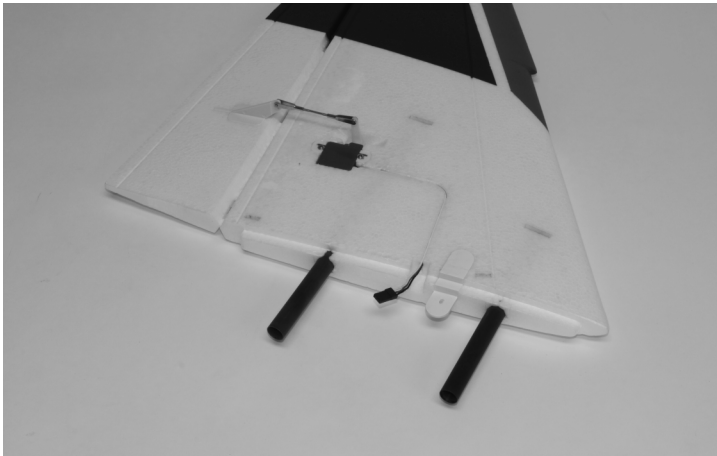

BATTERY INSTALLATION

Required Tools and Fasteners:

- (1) Hook Side Adhesive Backed Hook and Loop Strip
- (1) Hook and Loop Strap

1. Remove the canopy from the fuselage by pulling the canopy latch to the rear of the fuselage and lifting the canopy from the fuselage.
2. Apply a piece of hook-sided adhesive backed hook and loop strip to the battery tray.
3. Place the flight battery in the battery compartment and secure it with a hook and loop strap. Please note, the battery is placed toward the rear of the battery compartment.

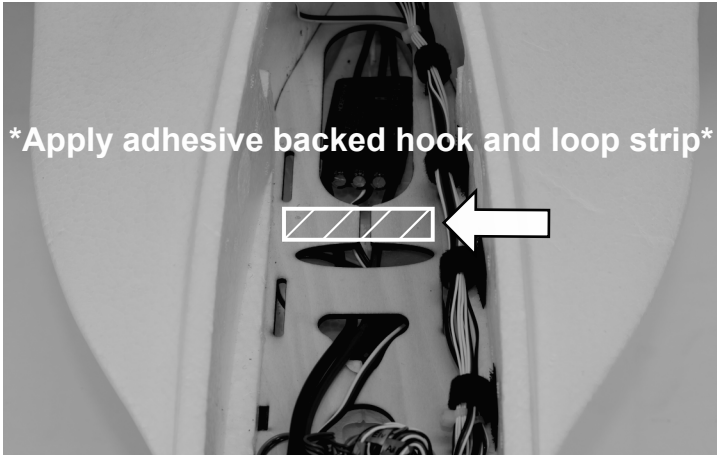

VERTICAL STABILIZER INSTALLATION

Required Tools and Fasteners:



- #1 Phillips Screwdriver, Emery Board, Felt-Tip Pen
- 15-30min Epoxy, Low-Tack Masking Tape
- M3x20mm Phillips Head Self-Tapping Screw

1. Apply a piece of low-tack masking tape to the inside of the fuselage covering the hole for the stabilizer tube.
2. Test fit the carbon fiber vertical stabilizer tube by inserting it into the hole of the fuselage, until it is flush with the bottom of the fuselage (meets the tape applied in step 1). If there is anything obstructing the tube, use a # 11 hobby knife to remove the obstruction.
3. Orient the servo towards the left of the fuselage and slide the vertical stabilizer halfway onto the fuselage. Plug in the rudder servo and fully seat the stabilizer to the fuselage, while being careful to align the stabilizer mounting slot with the tab on the fuselage. Be sure to avoid pinching wires during this process. Secure the stabilizer to the fuselage using a #1 Phillips screwdriver with a M3x20 Phillips head self-tapping screw. **Avoid over-tightening the screw, and do NOT use blue thread locker on this connection.**

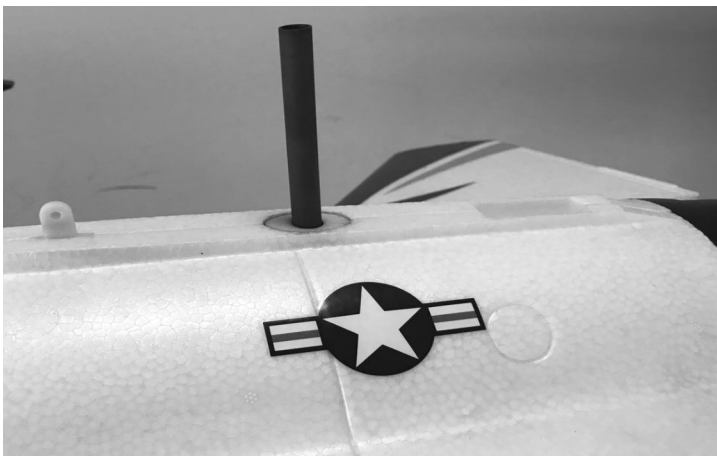

VERTICAL STABILIZER INSTALLATION (CON'T)

4. Position the FlexJet so that it is level. Standing approximately 10-20 feet (3-7 m) behind the aircraft, visually sight the vertical stabilizer, ensuring the installation is true and perpendicular relative to the fuselage. Use a file to fine-tune the plywood tube mount if needed.
5. After ensuring the vertical stabilizer is true, remove the stabilizer.
6. Mark the vertical stabilizer tube at the point where the tube exits the fuselage and remove it from the fuselage.
7. Mix and apply an appropriate amount of epoxy to the hole in the fuselage for the vertical stab tube and apply a thin coat to the tube that will be inserted into the fuselage. Insert the tube so that it is flush with the inner wall of the fuselage (touching the tape applied in step 1). Use a paper towel and isopropyl alcohol to wipe any excess epoxy off of the rudder tube that extends out of the fuselage and the fuselage itself. **Please note, if any excess epoxy remains on the vertical stabilizer tube and/or fuselage it will prohibit a flush fit of the fin to the fuselage as well as make vertical fin extremely difficult to remove. In addition, if the vertical stabilizer tube extends too far inside the fuselage, it will interfere with the thrust tube.**
8. Re-install the vertical stabilizer per step 3 and re-sight the stabilizer per step 4. It may be helpful to apply low-tack masking tape to the stabilizer and fuselage in a manner that temporarily holds the stabilizer in place as the epoxy cures.
9. Power on the radio system. Check the mechanical rudder trim by comparing the trailing edge of the rudder relative to the vertical stabilizer.
10. If adjustment is needed, remove the clevis from the control horn, and turn the clevis. Re-attach the clevis to the control horn and inspect the mechanical trim of the rudder. Repeat this step until the trailing edge of the rudder is centered relative to the vertical stabilizer.
11. Once satisfied with the mechanical trim of the rudder, apply a drop of blue thread locker at the point where the clevis and control linkage meets.
12. Inspect the glue joint of the fuselage and vertical stabilizer tube. If satisfied, remove the low-tack masking tape from inside of fuselage.

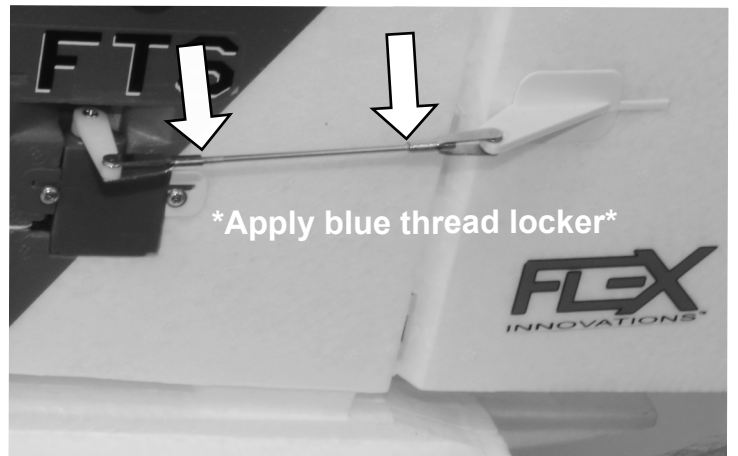
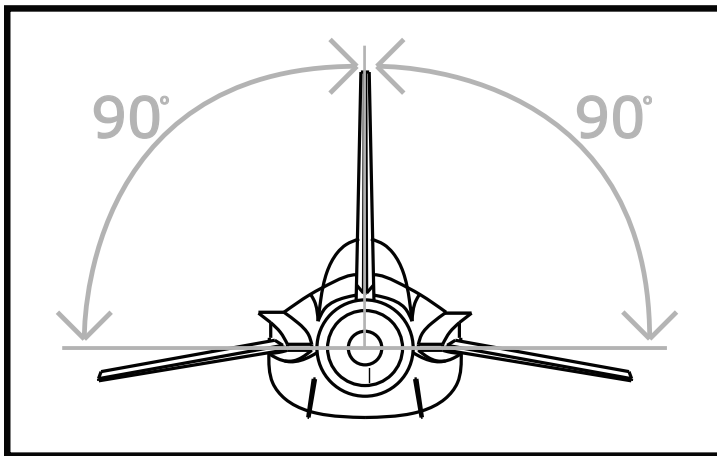
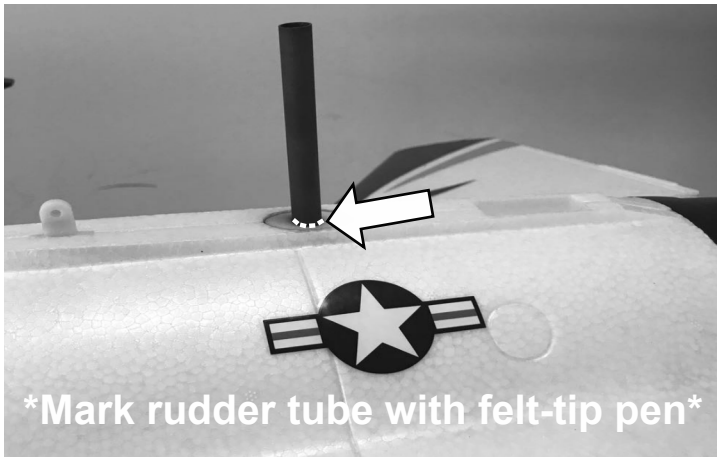

EDF ACCESS HATCH, TAIL PIPE, and EXHAUST NOZZLE RE-INSTALLATION

Required Tools and Fasteners:

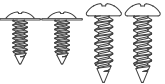

#1 Phillips Screwdriver
(2) M3x10 Phillips Washer Head Self-Tapping Screws, (2) M3x25 phillips Self-Tapping Screws
General Office Tape

1. Carefully collapse the tail pipe (without creasing) and insert the tail pipe into the fuselage until it reaches the EDF fan housing. **Note, the tail pipe is asymmetrical and can only be installed in one orientation. Make sure the side with the wider opening is inserted towards the EDF fan housing.**
2. Un-bend the tail pipe. Align the tailpipe with the fan housing, and 'tap' on the tailpipe's aft edge with your palm to help it move forward. Slide the tail pipe over the EDF Fan Housing.
3. Place the exhaust nozzle over tail pipe onto the fuselage. Secure the exhaust nozzle using a #1 Phillips screwdriver and (2) M3x25 Phillips self-tapping screws. **Note, the exhaust nozzle is asymmetrical and will only fit the fuselage in one orientation. Do not use blue thread locker on this connection.**
4. Slide the tail pipe until it is flush with the end of the exhaust nozzle. Once satisfied with the finish, secure the tail pipe to the EDF fan housing using the two included pieces of clear tape at the 2 and 10 o'clock orientation.
5. Secure the EDF access hatch to the fuselage using a #1 screwdriver and (2) M3x10 Phillips washer head self-tapping screws. **Note, the EDF access hatch is asymmetrical and will only fit the fuselage properly in one orientation. Do not use blue thread locker on this connection.**

Please note, a video of the EDF access hatch, tail pipe, and exhaust nozzle installation/reinstallation is available at <http://wiki.flexinnovations.com/wiki/FlexJet>.

Note cross-section of collapsed Tail Pipe

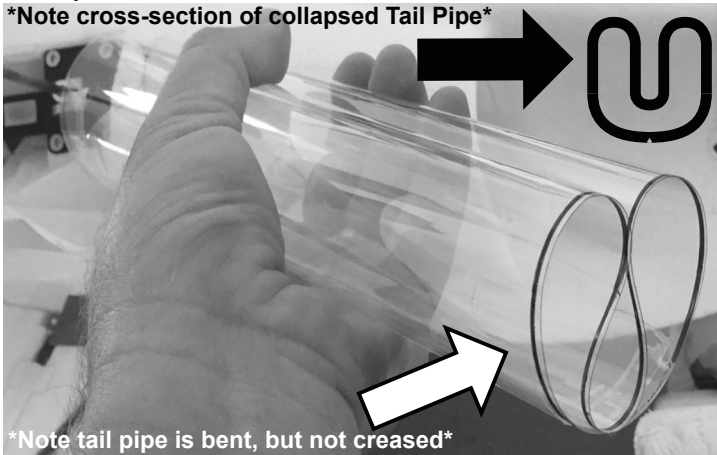

Note tail pipe is bent, but not creased

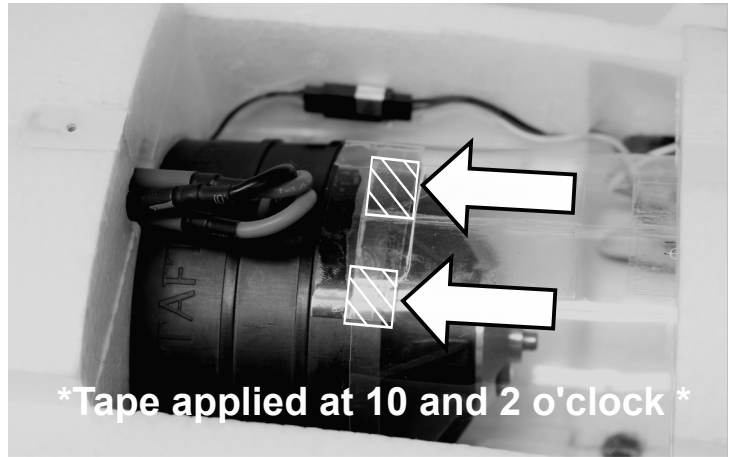
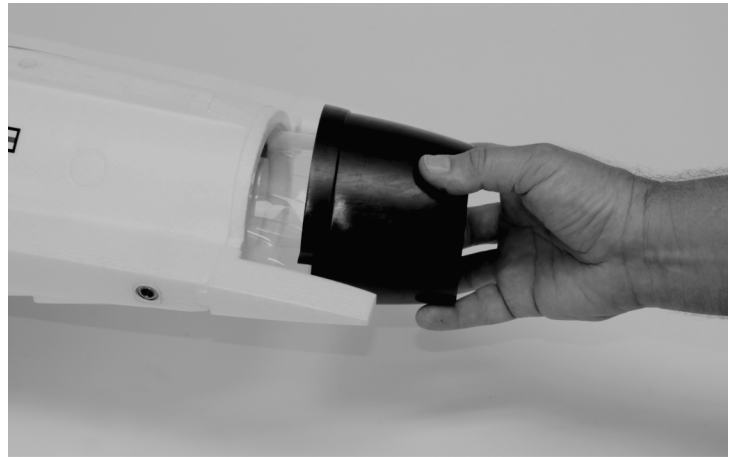

*Tape applied at 10 and 2 o'clock *

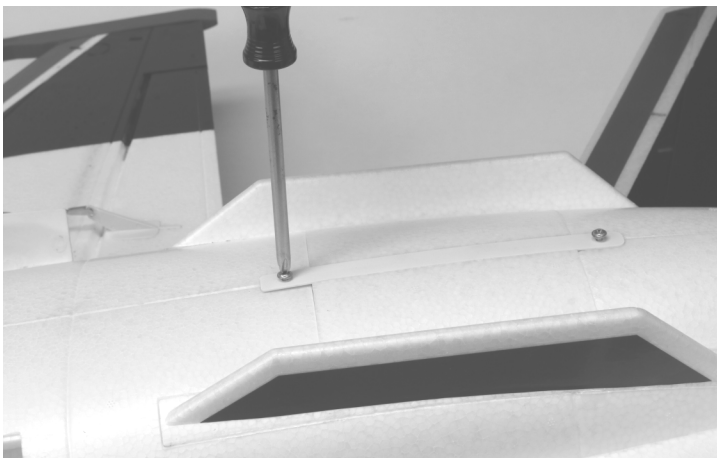

VENTRAL FIN INSTALLATION

Required Tools and Fasteners:

5-min Epoxy or Medium CA

1. Test fit the Ventral fin to the fuselage. **Please note, the ventral fins are asymmetrical and will only fit properly in one direction.**
2. Mix and apply an appropriate amount of 5-min epoxy to fuselage and ventral fin. Place the ventral fin onto the Fuselage. **Avoid applying glue to the EDF access hatch area.**
3. Using a paper towel and Isopropyl alcohol, wipe away any excess epoxy.



MISSILE RAIL INSTALLATION

Required Tools and Fasteners:

5-min Epoxy or Medium CA

1. Test fit the missile rails to the wings. **Please note, the missile rails are asymmetrical and will only fit properly in one direction.**
2. Mix and apply an appropriate amount of 5-min epoxy to the missile rail and wing. Place the missile rail onto the wing. **Avoid using too much glue as isopropyl alcohol will mar the paint of the FlexJet.**



TRANSMITTER CONTROL DIRECTION TEST

Refer to the chart below to determine the proper control surface directions relative to *transmitter stick input*. Please note, control surface movement in the chart have been exaggerated for clarity.

If controls are reversed, DO NOT REVERSE CONTROLS IN THE TRANSMITTER OR THE AURA CONFIG TOOL. Email us at support@flexinnovations.com for corrective action. Please note, that BOTH the Transmitter Control Direction Test AND the Flight Controller Sensor Direction Test (page 17) MUST BOTH BE PASSED! IF ONE DOES NOT PASS, DO NOT FLY!

Note: There is pre-configured rudder to aileron and rudder to elevator mixing programmed into the Aura. If you see elevator or ailerons move with rudder stick input, this function is intentional and completely **NORMAL**.

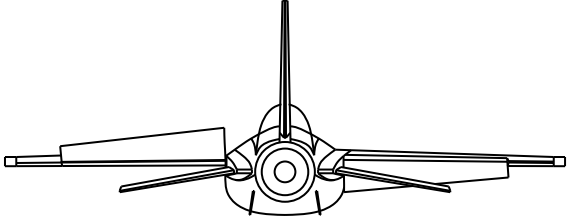
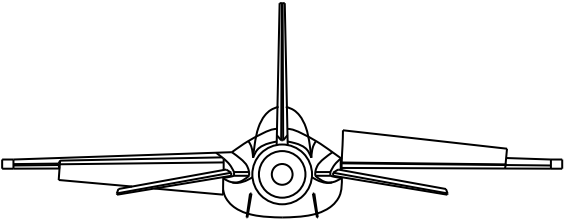
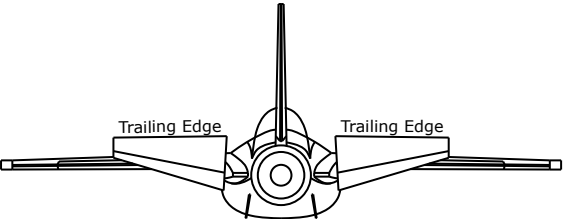
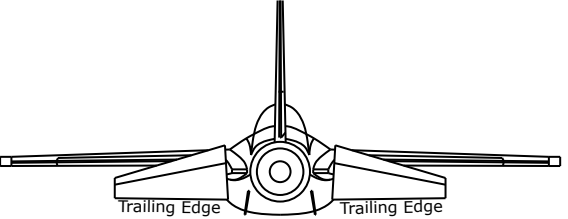
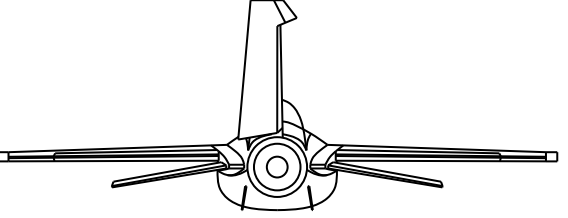
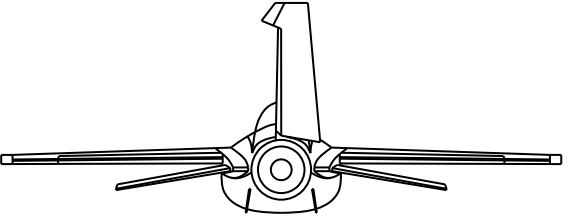
		Stick Movement	Proper Control Surface Deflection
AILERON	Stick Left		
	Stick Right		
ELEVATOR	Stick Aft		
	Stick Forward		
RUDDER	Stick Left		
	Stick Right		

FLIGHT CONTROL SENSOR DIRECTION TEST

Perform a test of the gyro system to verify the corrections made for a given movement are correct. If any of the tests do not result in the correct reaction for the airplane's gyro system, **DO NOT FLY THE AIRPLANE**, and contact us via email at support@flexinnovations.com.

The flight control system activates with RF broadcast. Perform these tests in Mode 3 (higher gain) for better visibility, and then again in Mode 2, and any other flight modes that have gyro gains assigned. (By default, Mode 1 has no gain assigned.) Control surface deflections are exaggerated in the drawings below for clarity. Please note that the control surfaces will move **ONLY** while the aircraft is **ROTATING**.

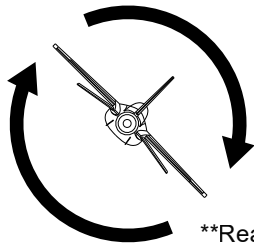
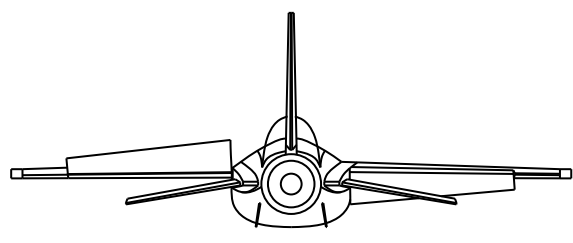
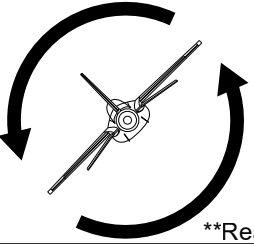
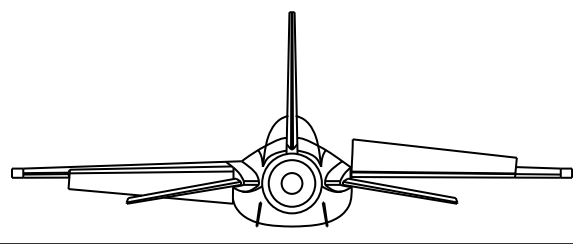
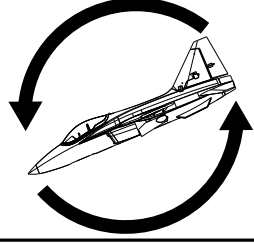
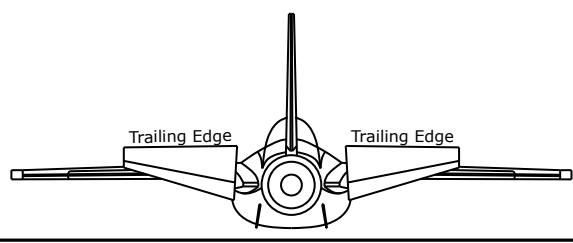
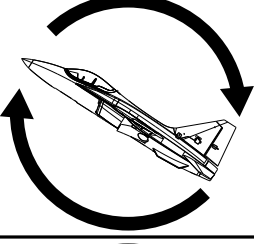
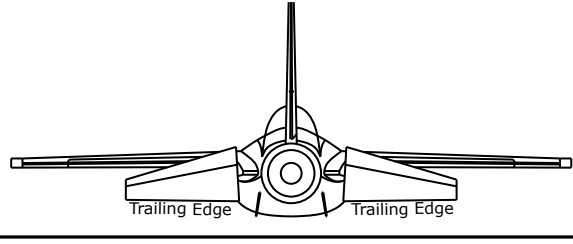
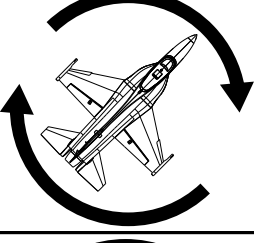
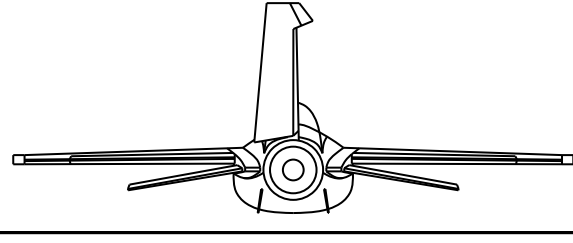
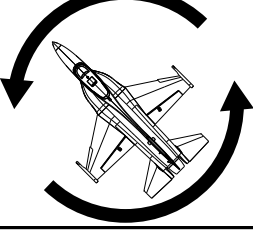
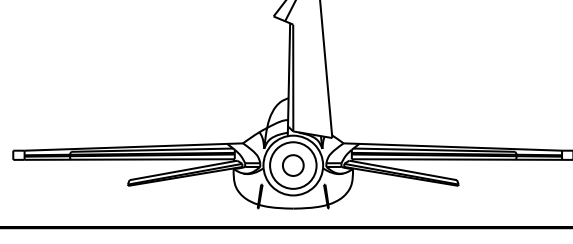
	Aircraft Movement	Proper Control Surface Deflection
AILERON	 <p>**Rear-View**</p>	
	 <p>**Rear-View**</p>	
ELEVATOR		 <p>Trailing Edge Trailing Edge</p>
		 <p>Trailing Edge Trailing Edge</p>
RUDDER		
		

CENTER OF GRAVITY VERIFICATION

The center of gravity (CG) location for the FlexJet is located **at the forward edge of the plastic wing bolt tab** and is measured by lifting the completed airplane upright, with all components installed and **the landing gear in the down position**. This location was determined from numerous test flights by designer and TopGun Champion David Ribbe.

Setting the center of gravity is one of the most important steps for success, particularly with a new airplane. The FlexJet is a high-performance airplane that can exceed speeds of 100mph. This makes it a very enjoyable aircraft to fly, but if the CG is not within an acceptable range, it will make the aircraft difficult, if not impossible to control. The desired CG can usually be accomplished by moving the flight battery forward or aft.

After flying the FlexJet you may adjust the CG up to 3/16" (4.76mm) forward or aft for personal preference.

NOTICE

The CG measurement should be made with the completed airframe with all components (batteries, servos, receiver, linkages, hardware, etc.) installed and the landing gear in the down position. Failure to do so will result in an inaccurate measurement.

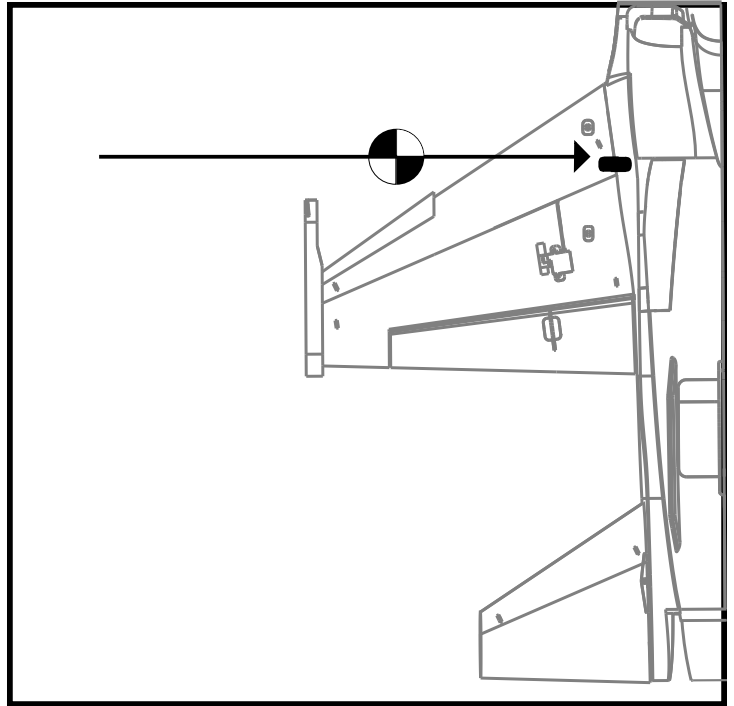

PRE-FLIGHT CHECKS

To help ensure a successful first flight, as well as many flights after, perform a few simple pre-flight checks to ensure the aircraft is ready for flight.

1. Verify control surfaces are properly hinged and in good working order. Pinch a control surface between your thumb and fore-finger, and stabilize the wing with your other hand. Give the control surface a firm pull away from the wing. The control surface should not come unhinged from the wing. Be sure to avoid over-stressing the part, as an aggressive pull may cause the surface to come unhinged even though it is hinged properly.
2. Verify that all hardware and all other aircraft parts are properly secured. This includes hardware and parts installed by the factory.
3. Verify your battery is fully charged and in good condition. Avoid using batteries with swollen cells, or batteries that do not charge back to their full capacity.
4. Verify the CG is in the proper location, and the battery is secured in place.
5. Ensure the Aura is on and functioning properly. Power on your transmitter, followed by the aircraft. Ensure the Aura is calibrated properly and receiving a valid radio source (solid orange + solid green LEDs).
6. Verify **transmitter stick inputs** result in the proper control surface movements (reference page 17).
7. Verify aircraft movement results in proper **Aura sensor corrections** (reference page 18).
8. Verify the motor and ESC function properly. Point the aircraft in a safe direction, and away from any objects or limbs that could become entangled in the fan unit. Hold the aircraft firmly so that you are behind the aircraft. Smoothly advance the throttle to full and back to idle. Listen and watch for any odd or unusual behavior from the motor and ESC.

FLYING YOUR FLEXJET

Selecting a Flying Site

Selecting a flying site is critical to a successful flight. Airplanes require a lot more room than other R/C products, therefore, a neighborhood or parking lot is not recommended. A local AMA field is the best location for flying your Flexjet. If no AMA field is available in your area, a large open field with short grass and generous overfly area is the best candidate. Know your overfly area. Ensure that there are no houses, playgrounds, people or other buildings that may be damaged if the airplane were to crash.



Takeoff

Taxi or place the FlexJet on the runway centerline, with the nose pointed into the wind. Select Mode 2, then set throttle trim so that the motor spins at it's lowest RPM without stopping. Smoothly advance the throttle to full while maintaining directional control with the rudder and slight back pressure on the elevator. The FlexJet should lift off smoothly once flying speed is attained. Fly in Flight Mode 2 until the FlexJet is fully trimmed (**see special trimming instructions**), and you are comfortable with it's handling, then explore the other modes as desired.

Flying

Altitude is your friend on the first flight. Briskly climb to a safe altitude and trim the airplane. The FlexJet should fly straight and level at 1/2-3/4 power with no input from the sticks. Try some basic maneuvers, and slowly progress into the FlexJet's flight envelope as you become more comfortable with the airplane's flight qualities and perfect your setup. **Note: if at any time, such as after gain adjustments, you experience unexpected control system inputs or oscillations, switch to Mode 1, land, and troubleshoot the issue. (Mode 1 turns the sensor inputs off with default programming)**

Landing

Be mindful of your flight time and allow adequate battery reserve for a couple of landing attempts, if necessary, on the first few flights. Select Flight Mode 2 and using 0 - 1/4 throttle slow the FlexJet to begin a landing approach. On the upwind leg, toggle Ch5/gear switch to deploy the gear. Visually confirm the gear are fully deployed. Once on final approach, smoothly apply up elevator as required to maintain 0-5 degrees of nose high angle of attack. Use throttle to control the descent speed. Once you are close to the ground, gradually reduce the throttle to idle and begin to smoothly apply up elevator as required to maintain 5-8 degrees of nose high angle of attack. The FlexJet should gently touch down and roll out with minimal elevator input. **Remember, you can always smoothly advance the throttle to full, and make a go-around to set up for another landing.** You don't have to land on the first attempt.

Trimming

The first several flights on your FlexJet should be dedicated to trimming and setup. Fly the airplane at 2/3 power in Flight Mode 2 and trim for level flight. Land, adjust linkages and return transmitter trim to zero, and fly again. Repeat until the airplane flies hands off, straight and level. Trim or sub-trim added via the transmitter will cause trim shifts when different flight modes are selected. To eliminate this trim shift, you have three options: **(1)** mechanically trim the model by turning the linkage clevises; **(2)** electronically trim the model via Subtrim Feature in the Servo Ports tab of the Aura Config Tool; **(3)** digital (non-PWM) receiver users can utilize the "Quick Trim" procedure below.

Trimming the Ailerons

Due to the FlexJet's large flight envelope, if your FlexJet is holding about 1/16th of an inch or more (1.5mm) of aileron trim it is likely that your Flexjet's aileron trim will change with speed changes. To properly trim the roll axis and prevent these trim changes, center the ailerons (mechanically or electronically) and use one of the techniques below to move the stabilizers in equal amounts in opposite directions to trim the roll axis: **(1)** mechanically trim the model by turning the linkage clevises; **(2)** electronically trim the model via Subtrim Feature in the Servo Ports tab of the Aura Config Tool; **(3)** digital (non-PWM) receiver users can utilize the "Quick Trim" procedure below.

Please reference **page 11** to adjust the flying stabilizers.

Pilots using a 'digital' receiver connection can accomplish this easily using the **Quick Trim** procedure. Start as instructed with the Ailerons perfectly mechanically centered. Fly and trim. Perform the Quick Trim procedure. Aura will put in any AILERON trim (along with Elevator trim) into the tail stabilizers instead of the ailerons, so your ailerons will return to being perfectly centered!

Aura Quick Trim

The Aura 8 features a Quick Trim Mode that eliminates the need for mechanical linkage adjustments during test flights. Aura will learn the trim values from your transmitter, and apply them to the control surfaces the next power-up.

NOTE: Quick Trim can also be used BEFORE flying to make small changes to adjust the control surfaces before flight.

NOTE: ENSURE AILERON/ELEVATOR/RUDDER SUB-TRIMS ARE ZERO BEFORE FLYING FOR QUICK TRIM PROCESS

NOTE: QUICK TRIM IS NOT AVAILABLE TO PWM CONNECTION USERS. IF YOU ARE USING A PWM CONNECTION, YOU WILL NEED TO **MECHANICALLY TRIM THE MODEL** or use the Subtrim in the Servo Ports of the Aura Config Tool.

1. Fly the airplane in Flight Mode 2. Trim the aircraft with the transmitter and land. **DO NOT CHANGE FLIGHT MODES.**
2. Power off the Aura. Insert a bind plug into Aura Port S3 (you will need to remove the servo lead that is currently in S3). Check the transmitter is on and repower the Aura.
3. Wait 5 seconds for the Aura to completely initialize. Confirm Quick Trim mode is active by checking the Blue LED is slowly flashing.
4. Remove the bind plug from **Aura Port S3**, and re-install the servo that was previously removed into S3. Removing the bind plug stores the current trims in the Aura. The Blue LED will flash quickly after control surface trim values are store. While the trim values are stored in Aura, they are not applied to the control surface(s) until the Aura is repowered.
5. Remove power from the Aura and center all control surface trims on the transmitter.
6. Re-power the Aura. The control surfaces are now adjusted for proper flight trim, even though the trim has been centered on the Transmitter. Switch between other Flight Modes to ensure you do not see any changes in trim.

ADVANCED FLEXJET AURA CONFIGURATION

The Aura 8 installed in the FlexJet is equipped with two possible Aura configurations - Stock and Expert. These may be accessed **WITHOUT THE USE OF the Aura Config Tool (WINDOWS-BASED PC OR TABLET programming application)** by using the Aura Quick Set feature. The "Expert" version offers three flight modes: Sport, Mid-High Rate and High Rate with tailerons.

NOTICE

The "Expert" flight modes cannot be configured by Quick Set when using PWM servo connections to Aura. If you are a PWM user, and wish to configure the Expert program, you must do so through the New Aura Config File Wizard in the Aura Config Tool (Windows-based Aura programming application)

Mode 1 - Low Rate

For sport or precision aerobatics.

Rates are low, expo adjusted for smooth flight.

Gains are set mid-low.

Mode 2 - Mid-High Rate

For spirited aerobatics.

Rates are mid-high, expo adjusted for smooth flight.

Gains are set middle.

Mode 3 - High Rate with Taileron

For aggressive aerobatics.

Rates are high, expo adjusted high for smooth flight.

Gains are set middle.

All flight modes can be flown at all speeds. Take-off and landing can be made in any flight mode, but the Low Rate is the smoothest and easiest.

1. Make sure all power is removed from the FlexJet. Be sure to unplug all three motor wires from ESC for safety.
2. Turn on your transmitter. Ensure you are on the correct model memory.
3. Remove the servo lead that is in Aura Port S2.
4. Insert a bind plug into Aura Port S2.
5. Power the FlexJet by plugging a battery into the ESC. The LEDs on the Aura will repeatedly double flash orange. This confirms you have entered Quick Set mode. The Green LED may be flashing, or solid. More information regarding the green LED is below.
6. Use the Aux1/CH6 switch (assigned earlier for Aura Flight Modes) to select the Expert or Stock Aura configurations.

If the green LED on the Aura is **SOLID**, the Aura is set to use the **STOCK** configuration.

If the green LED on the Aura is **FLASHING**, the Aura is set to use the **EXPERT** configuration.
7. You may optionally assign a Master Gain. (Before running Quickset, assign a proportional slider or knob to CH8/Aux3 in your transmitter). Master Gain will default to OFF when Quickset is run. **Sweep the CH8 Down and then UP. The RED LED will illuminate SOLID-ON for Master Gain ON, and OFF for master gain OFF.** Leave in the desired state/choice and continue.
8. Once you have selected your configuration, simply remove the bind plug from S2. All LEDs on Aura will be on while Aura is saving the settings. Once saved, the Aura will go back to its previous LED configuration from step 6. Power off the airplane and Aura, and replace the servo lead back into Aura Port S2.
9. Power on the radio system and verify that all controls function, and that both the transmitter direction test and Aura sensor direction test pass. Familiarize yourself with the new flight modes and their relative switch positions, and enjoy flying with your new flight modes!

The expert program is gyro-enabled in all 3 flight modes. If you wish to use a secondary switch to be able to turn the Aura off, we recommend using the Wizard in the Aura Config Tool, and setting up a Gyro Kill switch.

For more information on how to access the Expert program via the Aura Config Tool, please visit:

<http://wiki.flexinnovations.com/FlexJet>

EXPERT FLIGHT MODE 3 TRANSMITTER CONTROL DIRECTION TEST

Perform the following Transmitter control test, after installing (via quick set or Aura Config Tool) Aura 8 Expert configuration. **Please note, this control test is only for Mode 3**, to test modes 1 and 2 please reference *page 17*. *Please note*, Control Surface deflection has been exaggerated for clarity.

Refer to the chart below to determine the proper control surface directions relative to *transmitter stick input*.

If controls are reversed, DO NOT REVERSE CONTROLS IN THE TRANSMITTER OR THE AURA CONFIG TOOL. Email us at support@flexinnovations.com for corrective action. Please note, that BOTH the Transmitter Control Direction Test AND the Flight Controller Sensor Direction Test (page 18) MUST BOTH BE PASSED! IF ONE DOES NOT PASS, DO NOT FLY!

Note: There is pre-configured rudder to aileron and rudder to elevator mixing programmed into the Aura. If you see elevator or ailerons move with rudder stick input, this function is intentional and completely **NORMAL**.

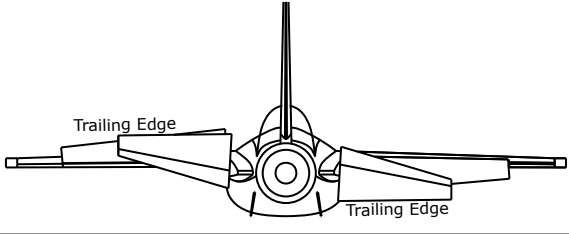
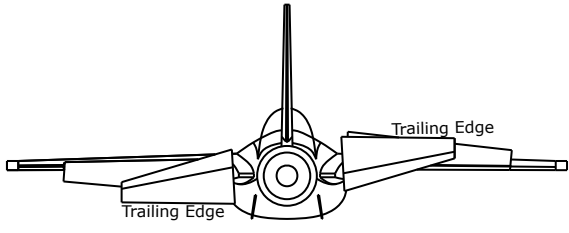
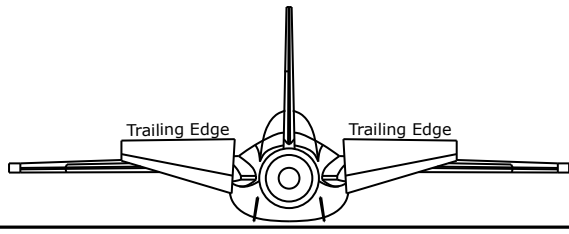
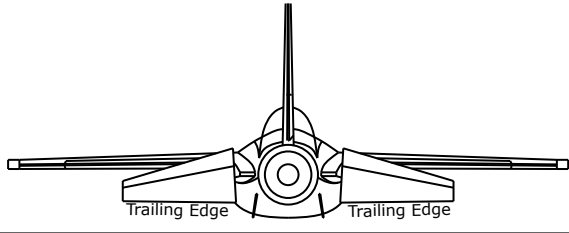
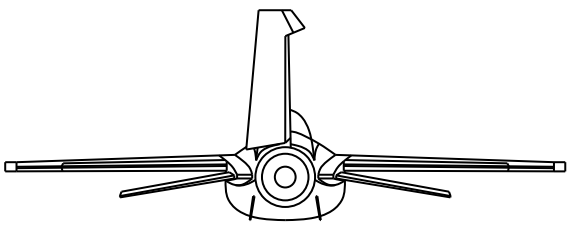
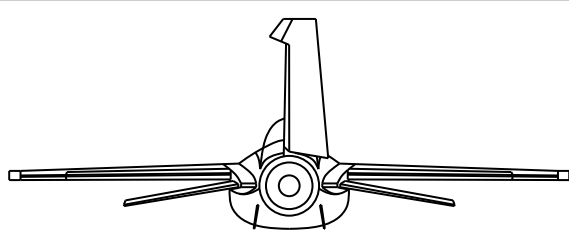
		Stick Movement	Proper Control Surface Deflection
AILERON	Stick Left		
	Stick Right		
ELEVATOR	Stick Aft		
	Stick Forward		
RUDDER	Stick Left		
	Stick Right		

AIRFRAME REPAIRS

The FlexJet is molded from durable EPO foam and is repairable with most adhesives. Similar to building and repairing wood or composite aircraft, the correct glue for a given application is critical to the repair holding and not breaking again. For major repairs, such as a broken fuselage, epoxy is preferred because it allows time to correct any misalignment, and is less brittle than CAs. For smaller repairs, such as a cracked control surface or small chunk of material missing from the airframe, regular CA is very effective. The use of odorless (foam safe) CA is not recommended on EPO foam because it is weaker than regular CA, takes a longer period of time to cure and the bond tends to be weaker.

NOTE: Avoid the use of CA accelerant in repairs. It can damage paint and will weaken the bond of the glue. If CA accelerant is used, be mindful of the locations of CA to prevent premature bonding of parts or bonding a hand or clamp to the airframe.

If a part is damaged too badly to be repaired, please refer to **Page 3** of this manual for a complete listing of available replacement parts.

NOTICE

If a crash is imminent, fully reduce the throttle to prevent further damage to the power system and reduce energy to lessen impact damage.

CRASH DAMAGE IS NOT COVERED UNDER WARRANTY

NOTE: Avoid keeping the aircraft in direct sunlight when not flying. Excessive heat can damage the airplane's structure, and UV light can permanently discolor decals.

REPLACING SERVOS

Required Tools and Fasteners: #1 Phillips Screwdriver

1. Disconnect the servo lead from its respective extension.
2. Unscrew the two servo mounting screws at each end of the servo case and remove.
3. Unscrew the servo arm screw from the servo, and remove the servo arm.

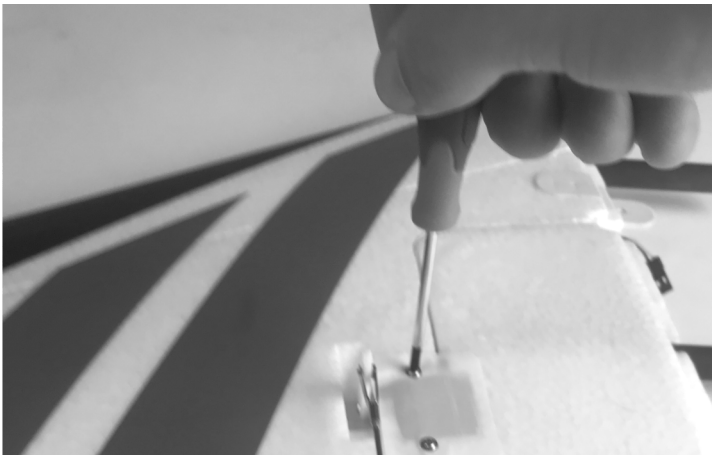

SERVICING THE POWER SYSTEM

Required Tools and Fasteners: #1 Phillips Screwdriver
M3 Hex Driver

1. Remove the access hatch, tail pipe, and exhaust nozzle as described on **page 10** of this manual.
2. Unplug the 3-motor wires from the ESC.
3. Using #1 Phillips screwdriver remove the M3x6 phillips washer head sheet metal screws that secure the EDF fan unit to the EDF mounting rails.
4. Using #1 Phillips screwdriver remove the M3x6 phillips machine screw that secures the rotor cone to the rotor.
5. Using an adjustable wrench, remove the M8 nut off of the motor adapter. Slide the motor adapter off of the motor shaft.
6. Using a M3 hex driver remove the (4) M3x6 that secure the motor to the EDF housing.
7. To remove the ESC, disconnect the ESC from the receiver or the Aura 8, and remove any cable ties holding the ESC to the fuselage.

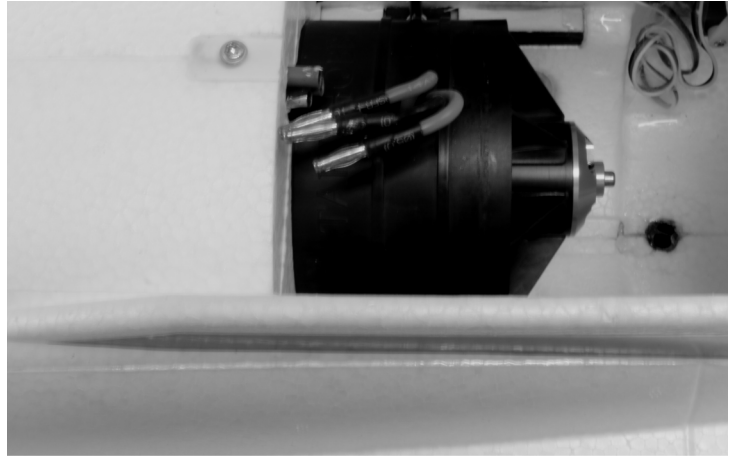
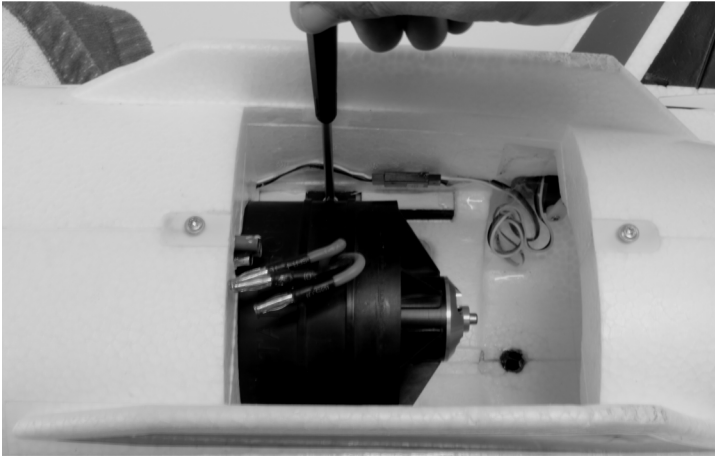

AIRCRAFT TROUBLESHOOTING GUIDE

Should you encounter any abnormal situations with your FlexJet, refer to the matrix below to determine probable cause and a recommended solution for the action.

If the required solution does not rectify the problem, please contact product support for further assistance.

! NOTICE

Unless specifically required, ALWAYS troubleshoot the airplane with the motor disengaged by unplugging all three motor leads from the ESC.

DISCREPANCY	PROBABLE CAUSE	RECOMMENDED SOLUTION
Motor nonresponsive (ESC initialization tones audible)	Throttle not at idle and/or throttle trim too high	Lower throttle stick and trim completely. If problem persists, ensure that the sub-trim and travel adjust are properly set in the radio's programming.
	Throttle channel is reversed	Reverse throttle channel in radio programming.
Motor nonresponsive (No ESC initialization tones audible)	Motor disconnected from ESC	Ensure plugs are fully seated. Check battery and/or plugs for damage and replace any damaged components found. DO NOT ATTEMPT TO REPAIR.
Motor turns in the wrong direction	The three motor wires are connected incorrectly to the ESC	Swap any TWO motor wires.
Reduced flight time or aircraft under powered	Flight battery not fully charged	Ensure battery is fully charged prior to installing in aircraft.
	Flight battery is weak or damaged	Remove battery from service and replace with a different battery.
	Ambient temperature is too cold	Ensure battery packs are adequately warm (70°F/21°C) before flight.
	Battery capacity too small for intended use	Replace battery with one of proper capacity and discharge capacity (C rating).
	ESC reaching preset LVC (low-voltage cutoff)	Recharge battery, or reduce flight time.
	Battery's discharge rating too low	Replace battery with one of a higher discharge rating.
Excessive fan noise and/or vibration	Damaged EDF Housing, rotor cone, fan rotor, prop adapter or motor	Replace damaged components. DO NOT ATTEMPT REPAIR.
	Fan rotor is not balanced	Balance or replace the fan.
	Fan adapter is not balanced	Balance or replace the adapter.
	Fan nut is loose	Tighten fan nut with properly sized wrench.
	Spinner is not fully in place or tightened	Loosen the spinner bolt, adjust as required and retighten bolt.
Control surface(s) non-responsive	Rotor cone or fan adapter threads not cut straight	Replace rotor cone or fan adapter. DO NOT ATTEMPT REPAIR.
	Airframe or control linkage system damaged	Replace damaged control system components. DO NOT ATTEMPT REPAIR.
	Transmitter model bound incorrectly, incorrect active model memory, incorrect Aura data input configuration, incorrect transmitter settings	Consult radio manual for proper binding and model selection instructions.
	Battery voltage too low	Use volt meter to check battery. Replace or recharge as necessary.
	Battery disconnected from ESC	Verify that battery is connected, and that the EC5 plugs are fully seated.
	Battery Eliminator Circuit (BEC) damaged	Replace ESC. DO NOT ATTEMPT REPAIR.
Failed control direction test	Damaged servo	Replace servo. DO NOT ATTEMPT REPAIR.
	Incorrect transmitter or Aura 8 setting. DO NOT FLY!	Reference transmitter and receiver sections of this manual. If no solution is found, contact customer support at support@flexinnovations.com .
Control surface oscillation	Exceeding maximum airspeed for configuration	Reduce airspeed.
	Fan rotor / rotor cone not balanced	Balance or replace fan rotor / rotor cone.
	Motor vibration	Inspect motor and motor mounting. Tighten screws as needed or replace motor.
	Loose Aura 8 Mounting	Realign and secure the Aura 8 to the aircraft.
	Excessive control linkage slop or play	Inspect control linkage system and replace components as necessary.
	Improper transmitter setup	Refer to the transmitter configuration guide in this manual to properly configure transmitter settings.
	Damaged rotor cone and/or fan	Replace rotor cone and rotor fan as needed. DO NOT ATTEMPT REPAIR.
	Improperly set master gain	Ensure master gain is set for proper gain value(s).
Trim changes between flight modes	Trims are not properly zeroed	Use Aura "Quick Trim" feature, or mechanically trim the model and reset transmitter trim to zero.
	Sub-trims are not properly zeroed	Use Aura "Quick Trim" feature, or mechanically trim the model and reset transmitter sub-trim to zero.
	Transmitter is out of calibration (aileron/elevator/rudder are not at neutral with sticks centered; reference transmitter monitor screen)	Calibrate transmitter (reference transmitter's instruction manual) or return transmitter to manufacturer for calibration.
PWM Receiver Connection type, and cannot get orange + green LED on Aura, and no control of model	Any of the four PWM cables not connected	Connect all four male to male servo cables between your receiver and Aura.
	Any of four PWM cables connected to incorrect ports	Connect all cables to the proper ports. Reference the diagram on the PWM receiver connections page of this manual.
	Polarity of any PWM cables incorrect	Reconnect servo cables with the proper polarity.
	Receiver not bound and/or outputting PWM servo pulses	Bind receiver per manufacturer's instructions and verify with a servo to ensure PWM signal is output from each channel as required.

LIMITED WARRANTY

Warranty Coverage

Flex Innovations, LLC. and its authorized resellers ("Flex") warrant to the original purchaser that the product purchased (the "Product") it will be free from defects in materials and workmanship at the date of purchase.

Outside of Coverage

This warranty is not transferable and does not cover:

- (a) Products with more than 45 days after purchased date.
- (b) Damage due to acts of God, accident, misuse, abuse, negligence, commercial use, or due to improper use, installation, operation or maintenance
- (c) Modification of or to any part of the Product.
- (d) Product not compliant with applicable technical regulations.
- (e) Shipping damage
- (f) Cosmetic damage
- (g) Products that have been partially, or fully assembled

OTHER THAN THE EXPRESS WARRANTY ABOVE, FLEX MAKES NO OTHER WARRANTY OR REPRESENTATION, AND HERBY DISCLAIMS ANY AND ALL IMPLIED WARRANTIES, INCLUDING, WITHOUT LIMITATION, THE IMPLIED WARRANTIES OF NONINFRINGEMENT, MERCHANTABILITY AND FITNESS FOR A PARTICULAR PURPOSE. THE PURCHASER ACKNOWLEDGES THAT THEY ALONE HAVE DETERMINED THAT THE PRODUCT WILL SUITABLY MEET THE REQUIREMENTS OF THE PURCHASER'S INTENDED USE.

Purchaser's Solution

Flex's sole obligation and purchaser's sole and exclusive remedy shall be that Flex will, at its option, either (i) service, or (ii) replace, any Product determined by Flex to be defective. Flex reserves the right to inspect any and all Product(s) involved in a warranty claim. Service or replacement decisions are at the sole discretion of Flex. Proof of purchase is required for all warranty claims. **SERVICE OR REPLACEMENT AS PROVIDED UNDER THIS WARRANTY IS THE PURCHASER'S SOLE AND EXCLUSIVE REMEDY.**

Limitation of Liability

FLEX SHALL NOT BE LIABLE FOR SPECIAL, INDIRECT, INCIDENTAL OR CONSEQUENTIAL DAMAGES, LOSS OF PROFITS OR PRODUCTION OR COMMERCIAL LOSS IN ANY WAY, REGARDLESS OF WHETHER SUCH CLAIM IS BASED IN CONTRACT, WARRANTY, TORT, NEGLIGENCE, STRICT LIABILITY OR ANY OTHER THEORY OF LIABILITY, EVEN IF FLEX HAS BEEN ADVISED OF THE POSSIBILITY OF SUCH DAMAGES.

Further, in no event shall the liability of Flex exceed the individual price of the Product on which liability is asserted. As Flex has no control over use, setup, assembly, modification or misuse, no liability shall be assumed nor accepted for any resulting damage or injury. By the act of use, setup or assembly, the user accepts all resulting liability. If you as the purchaser or user are not prepared to accept the liability associated with the use of the Product, purchaser is advised to return the Product immediately in new and unused condition to the place of purchase.

Law

these terms are governed by Florida law (without regard to conflict of law principals). This warranty gives you specific legal rights, and you may also have other rights which vary from state to state. **FLEX RESERVES THE RIGHT TO MODIFY THIS WARRANTY AT ANY TIME WITHOUT PRIOR NOTICE.**

Questions & Assistance

Visit www.flexinnovations.com/articles.asp?ID=269 to find customer support in your region.

Inspection or Services

If this Product needs to be inspected or serviced and is compliant in the region you live and use the Product in, please contact your regional Flex authorized reseller. Pack the Product securely using a shipping carton. Please note that original boxes need to be included, but are not designed to withstand the rigors of shipping without additional protection. Ship via a carrier that provides tracking and insurance for lost or damaged parcels, as Flex is not responsible for merchandise until it arrives and is accepted at our facility.

Warranty Requirements

For Warranty consideration, you must include your original sales receipt verifying the proof of purchase date, original packaging materials, including the shipping carton. Provided warranty conditions have been met, your Product will be replaced free of charge. Shipping charges are as follows: shipping to Flex paid by customer, shipping to customer paid by Flex. Service or replacement decisions are at the sole discretion of Flex.

COMPLIANCE INFORMATION FOR THE EUROPEAN UNION



Declaration of Conformity (In accordance with ISO/IEC 17050-1)

Product(s): FlexJet Super PNP Orange
FlexJet Super PNP Blue

Item Number(s): FPM3470A
FPM3470B

The object of declaration described above is in conformity with the requirements of the specifications listed below, following the provisions of the EMC Directive 2004/108/EC.

EN 55022: 2010+AC:2011
EN 55024: 2010
EN 61000-3-2: 2006+A2:2009
EN 61000-3-3: 2013

EN 61000-6-3: 2007/A1:2011
EN 61000-6-1: 2007



Instructions for disposal of WEEE by users in the European Union

This product must not be disposed of with other waste. Instead, it is the user's responsibility to dispose of their waste equipment by handing it over to a designated collections point for the recycling of waste and electronic equipment. The separate collection and recycling of your waste equipment at the time of disposal will help to conserve natural resources and ensure that it is recycled in a manner that protects human health and the environment. For more information about where to drop off your waste equipment for recycling, please contact your local city office, your household waste disposal service or where you purchased this product.



Academy of Model Aeronautics National Model Aircraft Safety Code

Effective January 1, 2015

- A. GENERAL:** A model aircraft is a non-human-carrying aircraft capable of sustained flight in the atmosphere. It may not exceed limitations of this code and is intended exclusively for sport, recreation, education and/or competition. All model flights must be conducted in accordance with this safety code and any additional rules specific to the flying site.
- Model aircraft will not be flown:
 - In a careless or reckless manner.
 - At a location where model aircraft activities are prohibited.
 - Model aircraft pilots will:
 - Yield the right of way to all human-carrying aircraft.
 - See and avoid all aircraft and a spotter must be used when appropriate. (AMA Document #540-D.)
 - Not fly higher than approximately 400 feet above ground level within three (3) miles of an airport without notifying the airport operator.
 - Not interfere with operations and traffic patterns at any airport, heliport or seaplane base except where there is a mixed use agreement.
 - Not exceed a takeoff weight, including fuel, of 55 pounds unless in compliance with the AMA Large Model Airplane program. (AMA Document 520-A.)
 - Ensure the aircraft is identified with the name and address or AMA number of the owner on the inside of affixed to the outside of the model aircraft. (This does not apply to model aircraft flown indoors.)
 - Not operate aircraft with metal-blade propellers or with gaseous boosts except for helicopters operated under the provisions of AMA Document #555.
 - Not operate model aircraft while under the influence of alcohol or while using any drug that could adversely affect the pilot's ability to safely control the model.
 - Not operate model aircraft carrying pyrotechnic devices that explode or burn, or any device which propels a projectile or drops any object that creates hazard to persons or property.

Exceptions:

- Free Flight fuses or devices that burn producing smoke and are securely attached to the model aircraft during flight.
 - Rocket motors (using solid propellant) up to a G-series size may be used provided they remain attached to the model during flight. Model rockets may be flown in accordance with the National Model Rocketry Safety Code but may not be launched from model aircraft.
 - Officially designated AMA Air Show Teams (AST) are authorized to use devices and practices as defined within the Team AMA Program Document. (AMA Document #718.)
- Not operate a turbine-powered aircraft, unless in compliance with
 - the AMA turbine regulations. (AMA Document #510-A.)
 - Model aircraft will not be flown in AMA sanctioned events, air shows or model demonstrations unless:
 - The aircraft, control system and pilot skills have successfully demonstrated all maneuvers intended or anticipated prior to the specific event.
 - An inexperienced pilot is assisted by an experienced pilot.
 - When and where required by rule, helmets must be properly worn and fastened. They must be OSHA, DOT, ANSI, SNELL or NOCSAE approved or comply with comparable standards.

B. RADIO CONTROL (RC)

- All pilots shall avoid flying directly over unprotected people, vessels, vehicles or structures and shall avoid endangerment of life and property of others.
- A successful radio equipment ground-range check in accordance with manufacturer's recommendations will be completed before the first flight of a new or repaired model aircraft.
At all flying sites a safety line(s) must be established in front of which all flying takes place. (AMA Document #706.)
 - Only personnel associated with flying the model aircraft are allowed at or in front of the safety line.
 - At air shows or demonstrations, a straight safety line must be established.
 - An area away from the safety line must be maintained for spectators.
 - Intentional flying behind the safety line is prohibited.

- RC model aircraft must use the radio-control frequencies currently allowed by the Federal Communications Commission (FCC). Only individuals properly licensed by the FCC are authorized to operate equipment on Amateur Band frequencies.
- RC model aircraft will not knowingly operate within three (3) miles of any pre-existing flying site without a frequency-management agreement. (AMA Documents #922 and #923)
- With the exception of events flown under official AMA Competition Regulations, excluding takeoff and landing, no powered model may be flown outdoors closer than 25 feet to any individual, except for the pilot and the pilot's helper(s) located at the flightline.
- Under no circumstances may a pilot or other person touch an outdoor model aircraft in flight while it is still under power, except to divert it from striking an individual.
- RC night flying requires a lighting system providing the pilot with a clear view of the model's attitude and orientation at all times. Hand-held illumination systems are inadequate for night flying operations.
- The pilot of an RC model aircraft shall:
 - Maintain control during the entire flight, maintaining visual contact without enhancement other than by corrective lenses prescribed for the pilot.
 - Fly using the assistance of a camera or First-Person-View (FPV) only in accordance with the procedures outlined in AMA Document #550.
 - Fly using the assistance of autopilot or stabilization system only in accordance with the procedures outlined in AMA Document #560

C. FREE FLIGHT

- Must be at least 100 feet downwind of spectators and automobile parking when the model aircraft is launched.
- Launch area must be clear of all individuals except mechanics, officials, and other fliers.
- An effective device will be used to extinguish any fuse on the model aircraft after the fuse has completed its function.

D. CONTROL LINE

- The complete control system (including the safety thong where applicable) must have an inspection and pull test prior to flying.
- The pull test will be in accordance with the current Competition Regulations for the applicable model aircraft category.
- Model aircraft not fitting a specific category shall use those pull-test requirements as indicated for Control Line Precision Aerobatics.
- The flying area must be clear of all utility wires or poles and a model aircraft will not be flown closer than 50 feet to any above-ground electric utility lines.
- The flying area must be clear of all nonessential participants and spectators before the engine is started.

If you are not an AMA member, please consider joining. Founded in 1936 and open to anyone interested in model aviation, the AMA is the governing body for model aviation in the United States and sanctions over 2,000 competitions annually. Membership in the AMA provides liability insurance coverage, protects modelers' rights and interests, and is required to fly at most of the 2,700+ R/C sites nationwide.

Academy of Model Aeronautics
5161 East Memorial Drive
Muncie, IN 47302-9252
Toll Free (800) 435-9262
Fax (765) 741-0057

www.modelaircraft.org



Elevator Trim Gauges

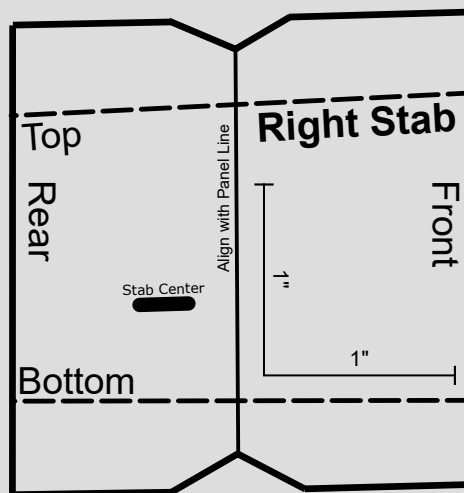
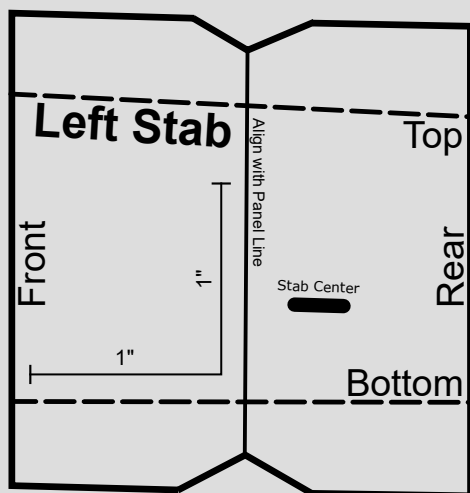

1. Cut-out the elevator trim gauges by cutting around the thick solid line. Do **not** cut through the center line.
2. Fold the elevator trim gauges at the dashed lines.
3. Verify the elevator trim gauges are printed at proper size by measuring the 1 inch vertical and horizontal scale.
4. Please reference page 10, step 3 for use with FlexJet

©2018 Flex Innovations, LLC.

Premier AircraftTM, PotenzaTM, and Top Value RCTM are trademarks or registered trademarks of Flex Innovations, LLC.
 DSM[®], DSM2TM, and DSMXTM are trademarks or registered trademarks of Horizon Hobby LLC
 FutabaTM is a registered trademark of Futaba Denshi Kogyo Kabushiki Kaisha Corporation of Japan.
 JetiTM, UDI, and Jeti Model are trademarks or registered trademarks of Jelen, Ing. Stanislav of Czech Republic
 Hitec is a trademark or registered trademark of Hitec RCD USA Inc.
 Graupner HoTT[®] is a registered trademark of Graupner Co., Ltd.