

DESIGNED BY:

Giuseppe Tompazini

SUPER PNP
Instruction Manual

FLEXTM
INNOVATIONS
www.flexinnovations.com

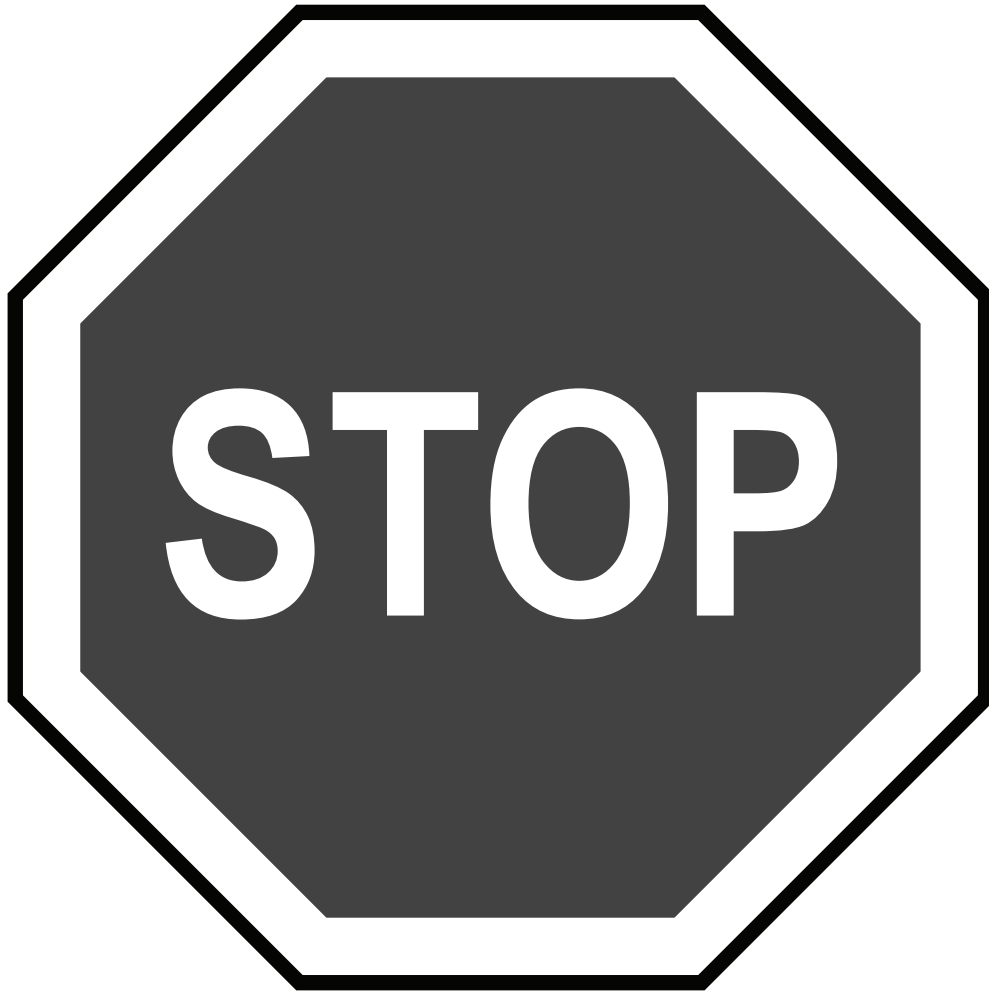

BEFORE CONTINUING WITH THIS INSTRUCTION MANUAL OR ASSEMBLY OF YOUR AIRCRAFT, PLEASE VISIT OUR WIKI PAGE SUPPORT SITE FOR THE LATEST PRODUCT UPDATES, FEATURE CHANGES, MANUAL ADDENDUMS, AND FIRMWARE CHANGES FOR BOTH YOUR AIRCRAFT AND THE INSTALLED FT AURA 5 LITE ADVANCED FLIGHT CONTROL SYSTEM.

**wiki.flexinnovations.com/wiki/Pirana
wiki.flexinnovations.com/wiki/Aura**

TABLE OF CONTENTS

Specifications.....	3	FPV Video Gear Installation (Optional).....	14, 15
Replacement Parts Listing.....	3	Battery Installation.....	16
Optional Completion Items.....	3	Connecting a Battery to the LED Controller.....	17
Completion Items	3	Propeller Installation.....	18
Battery Charging Guidelines	3	Center of Gravity Verification	18
Special Language Definitions.....	4	Control Direction Test.....	19
Important Information Regarding Warranty.....	4	Flight Control Sensing Direction Test.....	20
Safety Warnings and Precautions.....	4	Pre-flight Checklist.....	21
Low Voltage Cutoff.....	4	Launch Assist.....	21
FT Aura 5 Lite	5	Trimming.....	22
Transmitter Setup.....	6	Aura Quick Change Mode.....	23
Receiver Installation/Servo Connections.....	7	Flying Your Piraña.....	24
Connecting Battery/Arming ESC.....	7	Aircraft Troubleshooting Guide.....	25
Connecting/Binding your Receiver to Aura.....	8	Airframe Repairs.....	26
Connecting your Receiver to Aura.....	9	Replacing Servos.....	26
Aura Auto-Detect.....	9	Servicing the Power System.....	27
ESC Throttle Calibration.....	9	AMA Safety Code.....	28
Receiver Installation (Mounting Locations)	10	Limited Warranty.....	29
Wing Installation.....	11		
Vertical Fin Installation.....	12, 13		

INCLUDES

- Piraña assembled and painted airframe with decals applied
- FT Aura 5 Lite Advanced Flight Control System (programmed and ready to use)
- Potenza 20L 1200Kv Motor
- ZTW 50A ESC
- (2) Potenza DS17 Digital Servos
- (2) Potenza DS12 Digital Servos
- APC 6.5 x 6.5 Propeller
- (1) FPV Nose

REQUIRES

- 5+ Channel Computer Transmitter
- 6S 1300-1800 45C+ Li-Po Battery
- Serial-Capable Receiver

SPECIFICATIONS

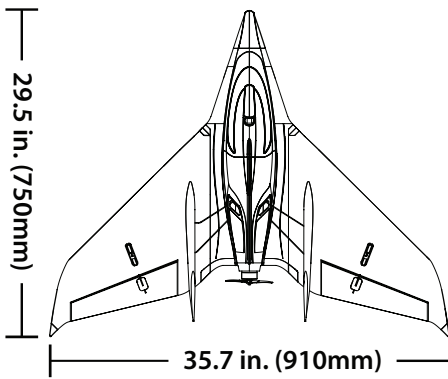

2lb 4oz (1020g)

RTF with 6S 1500mAh 45C battery installed



REPLACEMENT PARTS

FPM4170A	Piraña Super PNP (Orange)
FPM4170B	Piraña Super PNP (Yellow)
FPM417001A	Piraña Fuselage (Orange)
FPM417001B	Piraña Fuselage (Yellow)
FPM417002A	Piraña Wing Set (Orange)
FPM417002B	Piraña Wing Set (Yellow)
FPM417004A	Piraña Vertical Fin with Rudders (Orange)
FPM417004B	Piraña Vertical Fin with Rudders (Yellow)
FPM417005A	Piraña Speed Nose (Orange)
FPM417005B	Piraña Speed Nose (Yellow)
FPM417006A	Piraña FPV Nose (Orange)
FPM417006B	Piraña FPV Nose (Yellow)
FPM417007A	Piraña Decal Set (Orange)
FPM417007B	Piraña Decal Set (Yellow)
FPM417009	Piraña Plywood Floor w/screw
FPM417011	Piraña Hardware Set
FPM417011A	Piraña Rear Hatch (Orange)
FPM417011B	Piraña Front Hatch (Yellow)
FPM417012A	Piraña Front Hatch (Orange)
FPM417012B	Piraña Rear Hatch (Yellow)
FPZDS12P	Potenza DS12 Sub-Micro Servo for Piraña
FPZDS17	Potenza DS17 Sub-Micro Servo
FPZM1020LA	Potenza 20L Brushless Outrunner 1200KV Motor (6s)
FPZM1020L1	Potenza 1020L Prop Nut and Washer
FPZM1020L2	Potenza 1020L Aluminum Motor Mount
ZTW50A Pirana	ZTW 50A Piraña
LPO6565	APC 6.5x6.5 Prop
FPZA1016	Potenza Advanced R/C LED Controller (6s)

OPTIONAL ACCESSORIES

FPZA1010	Potenza Digital Battery Analyzer
FPZB15006S45	Potenza 6S 1500mAh 45C Li-Po Battery
FPZB15006S100	Potenza 6S 1500mAh 100C Li-Po Battery
FPZB18006S45	Potenza 6S 1800mAh 45C Li-Po Battery
SPM4651T	Spektrum DSMX SRXL 2 Receiver with Telemetry
SPM9745	Spektrum DSMX Remote Receiver
FUTR6202SBW	Futaba R6202SBW S.BUS FASST Receiver
FUTR2001SB	Futaba R2001SB S.BUS S-FHSS Receiver
FUTT6K	Futaba T6K Transmitter and Receiver
IDSTD2	iSDT D2 Smart AC Dual Battery Charger 100W x 2
FPZA1027	iSDT Charge Lead Adapter
FPM417003A	Piraña Vertical Fin (NO Rudders) (Orange)
FPM417003B	Piraña Vertical Fin (NO Rudders) (Yellow)
FPM417010	Piraña Video TX Mount

COMPLETION ITEMS

INSTALLED!	Potenza 20L 1200Kv Brushless Outrunner Motor (FPZM1020LA)
INSTALLED!	ZTW 50A ESC with 5.5V SBEC (ZTW50APirana)
INSTALLED!	Potenza DS12 Sub-Micro (2) and DS17 Sub-Micro (2) Digital Servos (FPZDS12) (FPZDS17)
INSTALLED!	FT Aura 5 Lite Advanced Flight Control System (FLT8050)
INCLUDED!	APC 6.5x6.5 Propeller (LPO6565)
NEEDED TO COMPLETE	1500mAh 6S 22.2v 45C or higher Li-Po Battery (FPZB15006S45)
NEEDED TO COMPLETE	5+ Channel Computer Transmitter
NEEDED TO COMPLETE	5+ Channel Serial Receiver

BATTERY CHARGING GUIDELINES

WARNING

FOLLOW ALL INSTRUCTIONS PROVIDED BY YOUR BATTERY AND CHARGER MANUFACTURER. FAILURE TO COMPLY CAN RESULT IN FIRE.

The assembly of the Piraña can be accomplished in less than one hour. Prior to assembling the airplane, it is advisable to charge your battery so that you are ready to begin setup upon completion of the assembly of your model.

We recommend the use of an advanced Li-Po balancing charger for your batteries to get the maximum performance and lifespan from them.

Our airplanes are designed around our Potenza Li-Po batteries and we recommend the Potenza 6S 1500 Li-Po (FPZB15006S45) in the Piraña based on our extensive testing and development.

This battery features an EC3 connector, no soldering is required for use in your Piraña.

All are available online at www.flexinnovations.com and your local Flex Innovations retailer.

SPECIAL LANGUAGE DEFINITIONS

The following terms are used throughout the product literature to indicate various levels of potential harm when operating this product:

- NOTICE:** Procedures, which if not properly followed, create a possibility of physical property damage AND a little or no possibility of injury.
- CAUTION:** Procedures, which if not properly followed, create the probability of physical property damage AND a possibility of serious injury.
- WARNING:** Procedures, which if not properly followed, create the probability of property damage, collateral damage, and serious injury OR create a high probability of serious injury.

WARNING

AGES 14+

This product is not intended for use by children under 14 years without direct adult supervision.

ATTENTION

Read the ENTIRE instruction manual to become familiar with the features of the product before operating. Failure to assemble or operate the product correctly can result in damage to the product, personal property, and cause serious or fatal injury.

All instructions, warranties and other collateral documents are subject to change at the sole discretion of Flex Innovations LLC, Inc. For up-to-date product literature, please visit our website at www.flexinnovations.com and click on the Piraña and LT Aura 5 Lite product pages.

IMPORTANT INFORMATION REGARDING WARRANTY

Please read our Warranty and Liability Limitations section before building this product. If you as the Purchaser or user are not prepared to accept the liability associated with the use of this Product, you are advised to return this Product immediately in new and unused condition to the place of purchase.

SAFETY WARNINGS AND PRECAUTIONS

Protect yourself and others by following these basic safety guidelines.

1. This manual contains instructions for safety, operation and maintenance. It is essential to read and follow all the instructions and warnings in the manual, prior to assembly, setup or use, in order to operate correctly and avoid damage or serious injury.
2. This model is not a toy, rather it is a sophisticated hobby product and must be operated with caution and common sense. This product requires some basic mechanical ability. Failure to operate this product in a safe and responsible manner could result in injury or damage to the product or other property.
3. This model must be assembled according to these instructions. Do not alter or modify the model outside of these instructions provided by Flex Innovations, LLC, as doing so may render it unsafe and/or unflyable. It is your responsibility to ensure the airworthiness of the model.
4. Inspect and check operation of the model and all its components before every flight.
5. If you are not an experienced pilot or have not flown a high-performance model before, it is recommended that you seek assistance from an experienced pilot in your R/C club for your first flights. If you're not a member of a club, the Academy of Model Aeronautics (AMA) has information about clubs in your area whose membership includes experienced pilots.
6. Never fly in visible moisture or submerge the airplane or any of its electronic components in water. Permanent damage to electronic components may occur, or corrosion of components may lead to intermittent failures.

LOW VOLTAGE CUTOFF

Li-Po batteries have a nominal (rated) voltage of 3.7v per cell, and fully charged, reach 4.2v per cell. Batteries are designed to be discharged below the nominal voltage. However, if they are discharged below 3.0v per cell, damage will occur and the pack will lose capacity. For best long term battery life, set a timer and land after a time that leaves approximately 15% of the battery's capacity remaining.

Low voltage cutoff is a feature that is built into the ZTW 50A ESC that is designed to protect the connected battery from being discharged too far and causing permanent damage to the cells. Circuitry within the ESC will automatically detect when the input voltage from the battery pack reaches below 3.0V per cell (average) and will remove power to the motor, but still deliver power to the servos so that a safe landing can be made. If the motor begins to lose power rapidly during flight, the LVC has sensed that the total voltage of the pack has dropped below 3.0V per cell average and the airplane should be landed immediately.

The FT Aura 5 Lite AFCS (Advanced Flight Control System) comes programmed and installed in your Piraña, making setup a breeze. This highly-refined 3-axis gyro makes the aircraft fly like it is a larger aircraft and in less wind. Thanks to the Aura's advanced implementation, it not only enhances the flying experience, but it never interferes with the Pilot's control.

The FT Aura 5 Lite comes configured with Flight Modes (dual rates, expos and gyro settings) set by the Flex Innovations team, and offers a great starting point for most pilots. Since these are already configured for you in the Aura, there is no need to set up dual rates or expos in your transmitter. Simply follow the Transmitter Configuration Guide in this manual for complete details on the transmitter programming required for the Piraña and FT Aura 5 Lite.

Visit wiki.flexinnovations.com/wiki/Aura for the latest Aura-related product information and updates.

Description of Pre-Loaded Aura Light Modes

Mode 1 (Sport, Gyro Off) - Gyro gain is set to off. All rates are set to low, and exponential is tuned for comfortable flight.

Mode 2 (Sport, Gyro On) - Gyro gain is set to low. All rates are set to low and exponential is tuned for comfortable flight.

Mode 3 (Advanced, Gyro On) - Gyro gain is moderate. All rates are set to high and exponential is tuned for comfortable flight.

Each of the modes are tuned by the Flex Team to offer a solid starting point. Individual preferences can vary, so sometimes changes in rates and expo are required to better suit individual preferences. Adjustments should be made in the FT Aura 5 Lite via the Aura Config Tool, **NOT** in the transmitter. Changes in gain value can only be made through the Aura.

TRANSMITTER SETUP

WARNING

DO NOT ATTEMPT RADIO SETUP WITH PROPELLER INSTALLED. INAVERTENT POWER UP
COULD CAUSE DEATH OR SERIOUS INJURY

The included FT Aura 5 Lite is designed to work seamlessly with all popular transmitter and receiver brands, however, transmitter setup is significantly different than when setting up a model without Aura.

When programming your transmitter, start with a freshly reset, new model memory in your transmitter. Make ONLY the changes shown in the Transmitter Configuration Guide.

TRANSMITTER CONFIGURATION GUIDE						
	Spektrum, Futaba, JR ¹ & Graupner		FrSky		Jeti (Ex-Bus)	
Wing/Tail Type	1 Aileron, 1 Elevator, 1 Rudder		1 Aileron, 1 Elevator, 1 Rudder		1 Aileron, 1 Elevator, 1 Rudder	
End Points (Travel, EPA, or ATV)	Ail/Ele/Rud Thro/CH5/CH6	125% 100%	Ail/Ele/Rud Thro/Ch5/Ch6	100% 84%	Ail/Ele/Rud Thro/CH5/CH6	100% 80%
Reversing	Not Allowed ²					
Sub Trim	Verify at zero, NOT ALLOWED					
Trim Levers	Verify at zero					
CH5 (Gear)	Assign to a 3-position switch					
Timer ³	Set to 4:00 for initial flights					

1. JR XBUS, Mode A is shown in the chart above, and is the preferred method to connect to Aura.
2. If you are using a Futaba transmitter, please note that some Futaba transmitters have the throttle set to reversed by default. We recommend that you leave the reversing set to the defaults and reverse it if needed after testing.
3. This aircraft can typically fly anywhere between 4 and 7 minutes (w/6S 1500mAh Li-Po), depending on flying style.

FOR CUSTOMERS USING TRANSMITTERS OTHER THAN WHAT IS LISTED IN THE CHART ABOVE, PLEASE VISIT
OUR WIKI PAGE FOR INSTRUCTIONS SPECIFIC TO YOUR TRANSMITTER AND RECEIVER BRAND

HITEC

wiki.flexinnovations.com/wiki/Aura/HitecSbusUse

RECEIVER INSTALLATION/SERVO CONNECTIONS

Choosing a Receiver

Aura will auto-detect modern serial receiver connections. For use in the Piraña, only a serial receiver connection or a Spektrum Remote Receiver can be used. Below are a few examples of receivers that can be used with the FT Aura 5 Lite. This is not a complete list of compatible receivers, rather a short list to assist you in your receiver selection.

Supported Serial Receivers

- Spektrum Remote Receiver** - SPM9645, SPM9745
- Spektrum SRXL** - SPMAR8010T, SPMAR9030T
- Spektrum SRXL2** - SPM4651T, SPM4650
- Futaba S.BUS** - Futaba R2001SB, R6202SBW, R7008SB
- Hitec S.BUS** - Optima SL, Maxima SL
- FrSky S.BUS** - RX4R, RX6R
- Graupner HOTT (Sum D of 8)** GR12L, GR16L
- JR XBus (Mode A & Mode B)** - RG012BX, RG613BX, RG821BX
- Jeti EX-Bus** - REX10, R9 EX, REX6

DEFAULT AURA CONNECTIONS	
S1.....	Throttle
S2.....	Left Elevon
S3.....	Right Elevon
S4.....	Left Rudder
S5.....	Right Rudder
Port B.....	Serial Receiver Input
Mini Port B....	Spektrum Remote Receiver Input

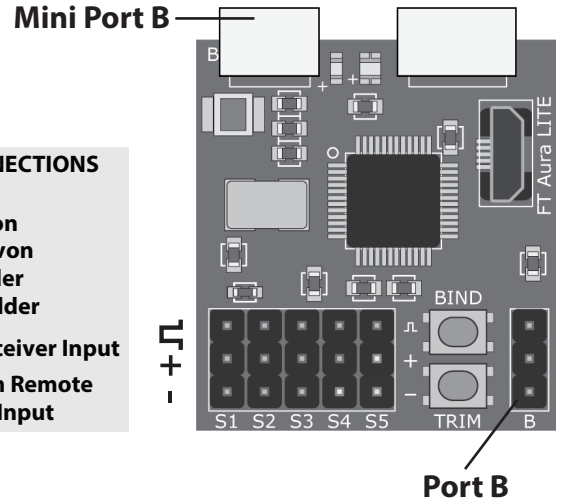

CONNECTING A BATTERY/ARMING THE ESC

Observe the following procedures to safely power up your model after it has been bound.

1. Ensure the propeller is removed unless this sequence is followed to power up before flight.
2. Turn on the transmitter, lower the throttle stick AND throttle trim to their lowest settings. Be sure to wait for your transmitter to indicate the radio signal is being broadcast before proceeding.
3. If a battery is connected to the ESC with throttle fully open on the transmitter, the ESC will enter programming mode. If this occurs, simply disconnect the battery, lower the throttle and reconnect the battery.
4. Ensure the aileron, elevator, and rudder gimbals are centered.
5. With the airplane on a solid surface, connect the battery to the ESC and wait. The ESC will make the motor emit a series of audible tones during its initialization process.
6. The ESC will make the motor emit a short, final tone sequence indicating that the ESC is now armed and the motor will spin in response to throttle stick movement.

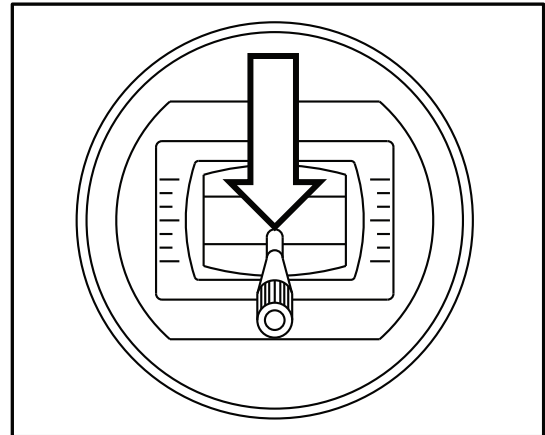

⚠ CAUTION

ONLY CONNECT THE BATTERY WHEN THE THROTTLE STICK AND THROTTLE TRIM IS IN THE IDLE (CUT-OFF) POSITION.

CONNECTING YOUR RECEIVER TO AURA

Spektrum Remote Receivers

If using a Spektrum Remote Receiver, connect it to Aura Mini Port B using the cable provided with your receiver.

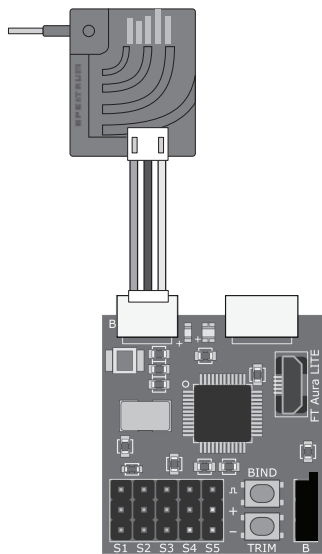

Binding Your Receiver

1. With your transmitter and receiver powered OFF, press and hold the bind button on the FT Aura 5 Lite.
2. Power on the FT Aura 5 Lite and your aircraft by connecting the flight battery to the ESC.
3. Release the bind button on the FT Aura 5 Lite, and confirm that the remote receiver is rapidly flashing orange.
4. Follow your transmitter manual for binding. This is typically done by holding the bind button on your transmitter while simultaneously powering it on.

Serial Receivers

If using a standard serial receiver, connect the provided male to male cable to your receiver's serial port. Connect the other end of the cable to Aura Port B noting proper polarity.

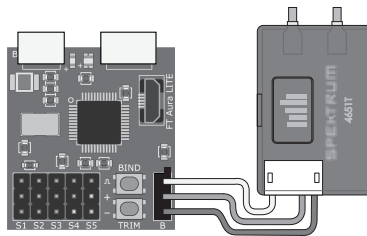

Note: The Spektrum 4651T receiver requires the use of a different cable to connect to Aura. The cable is included with the receiver when it is purchased directly from Flex Innovations. You can also purchase the cable itself at flexinnovations.com (FPZA1039)

Note: If you are using Futaba S.Bus, be sure to use the proper S.BUS port in your receiver. **DO NOT** use the S.BUS2 port, as it is not supported with the FT Aura 5 Lite. Refer to your manufacturer's instructions for proper S.Bus use.

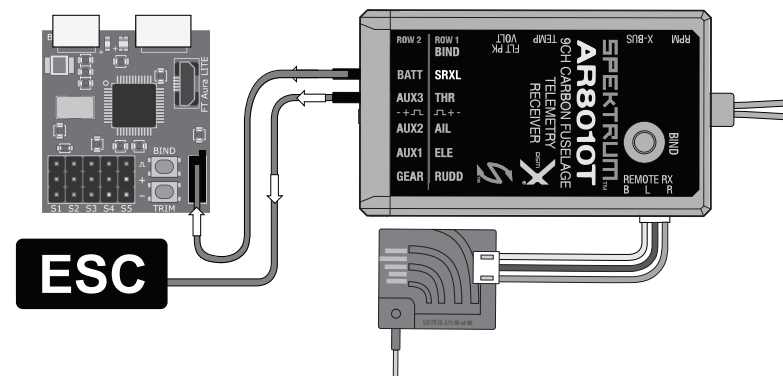
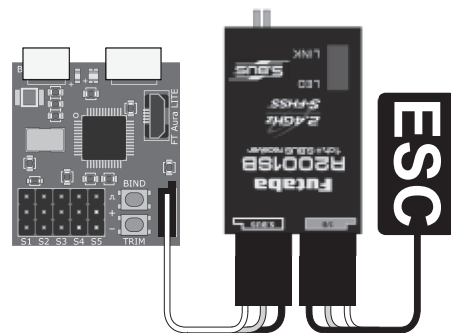

Note: When using Spektrum SRXL to connect to the Aura, always connect the remote receivers to the Spektrum receiver, NOT the Aura

Binding Your Receiver

Bind your receiver to your transmitter per your receiver and transmitter manufacturer's instructions.

Note: If your serial receiver has a working throttle port while it sends serial data, USE IT. Plug the ESC lead into the throttle port of your receiver.

CONNECTING YOUR RECEIVER TO AURA (Auto-Detect)

FT Aura 5 Lite Auto-Detect

Once your receiver is bound, powered, and connected to the Aura, the Aura will begin the Auto-Detect process to learn what type of receiver you are using and set itself up for that specific system.

Auto-Detect is indicated by a series of sweeping LEDs of various colors on the FT Aura 5 Lite. After Auto-Detect is completed, verify that Aura is on and receiving data from your receiver by looking at the LEDs on the Aura.

Ready-To-Fly:



Solid Orange LED (Aura On and Calibrated)
Solid Green LED (Aura Receiving Valid receiver data)

Possible Errors:



Flashing Orange LED (Aura Moved During Power Up)
No Green LED (Aura NOT Receiving Receiver Data)

ESC THROTTLE CALIBRATION

In order to map the full range of the ESC output to your throttle stick motion you will have to perform an ESC throttle calibration.

NOTE: Execute ESC throttle calibration with the propeller removed.

1. Power ON your transmitter, DISABLE any throttle hold or throttle kill switches, completely lower the throttle trim and set the stick to full throttle.
2. Connect the flight pack to your Piraña.
3. Listen for tones coming from the ESC through the motor. After about two seconds, you should hear two tones.
4. Pull the throttle stick back to idle.
5. Listen for the ESC to confirm with two tones from the motor, followed by the arming tones.

The ESC throttle range has now been properly calibrated, and is stored in the ESC's memory until it is calibrated again. You can repeat this process as many times as necessary.

RECEIVER INSTALLATION (MOUNTING LOCATIONS)

Required Tools and Fasteners

#1 Phillips Screwdriver
#2 Phillips Screwdriver

1. Lift the forward hatch off of the fuselage by lifting at the front and pulling the hatch forward away from the fuselage. Remove the (4) rear hatch screws using a #2 Phillips screwdriver, and lift the rear hatch off the fuselage.

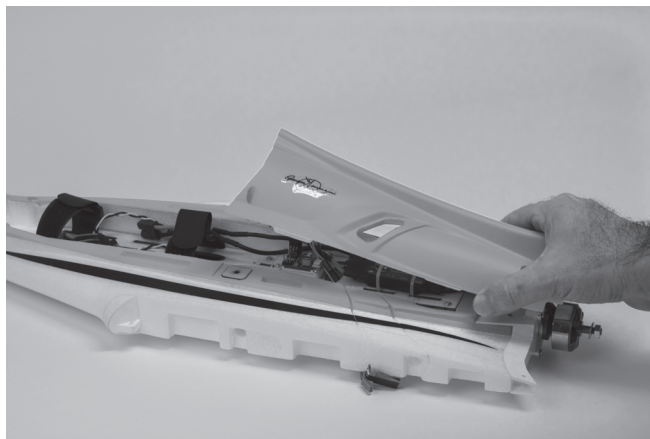
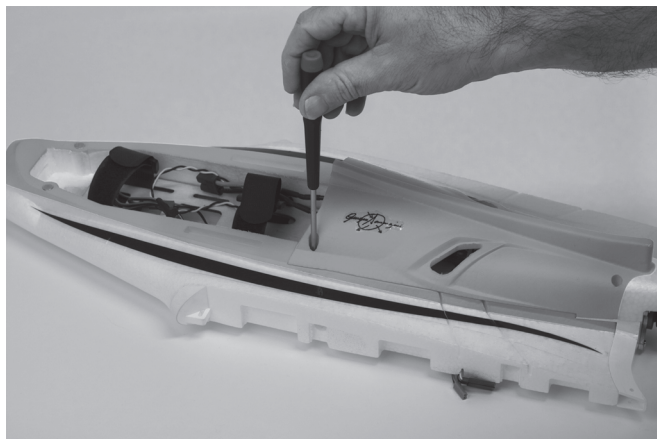

2. Both forward and rear plywood trays can be removed with a #1 Phillips screwdriver, offering plenty of space for mounting your receiver. If using a Spektrum Remote Receiver, there is additional mounting locations in the vertical fins. Follow your receiver manufacturer's instructions for details on how to mount your receiver(s).

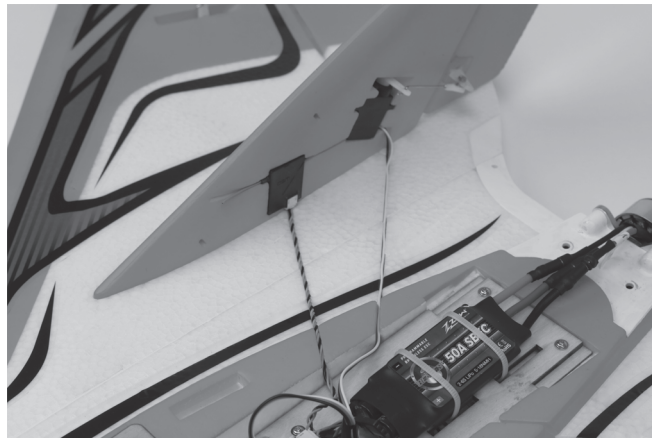
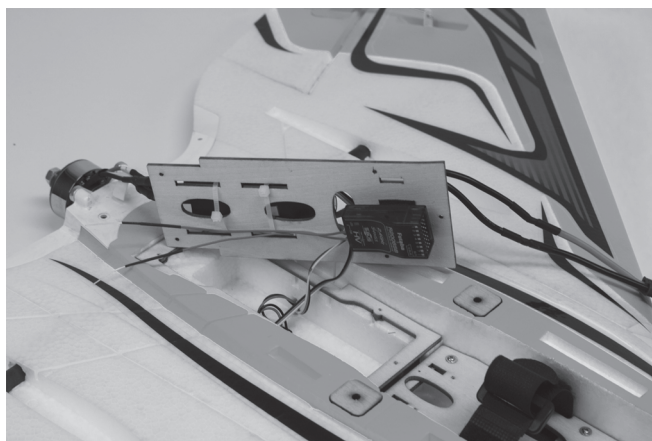
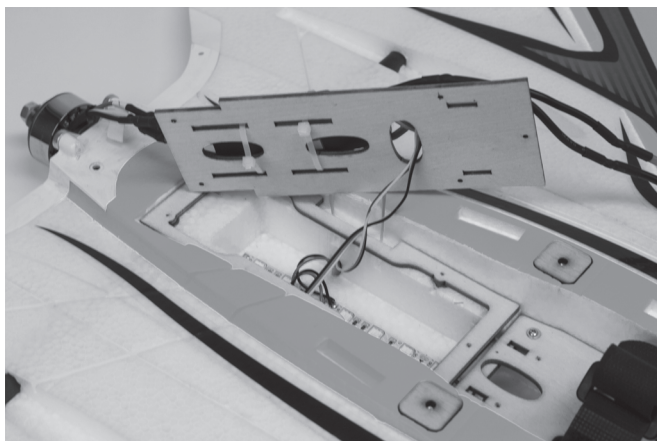

WING INSTALLATION

Required Tools and Fasteners

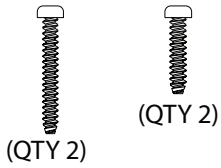

#2 Phillips Screwdriver

Front: (2) M3x15 Phillips head self-tapping screws

Rear: (2) M3.5x10 Phillips head self-tapping screws

1. Locate both wings and wing tubes.
2. Insert both wing tubes into the fuselage, noting that the short tube is installed at the front, and the long tube is installed at the rear.

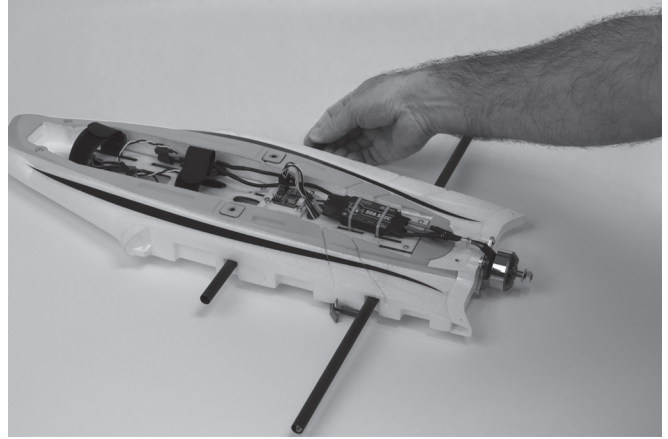
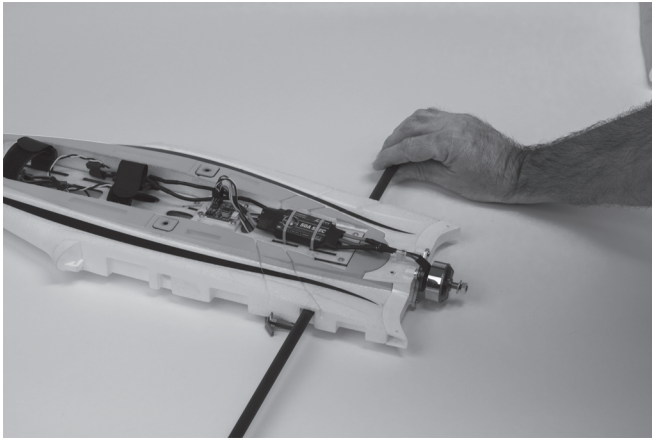

3. Slide a wing panel onto the wing tube until only a small gap is left. Connect the elevon servo wire, as well as the LED JST wire, and fully seat the wing to the fuselage, being careful to avoid pinching the elevon and LED wires.
4. Secure each panel with (1) M3x15 self-tapping Phillips head screw at the front, and (1) M3.5x10 Phillips head self-tapping screw at the rear. Repeat for the other side.

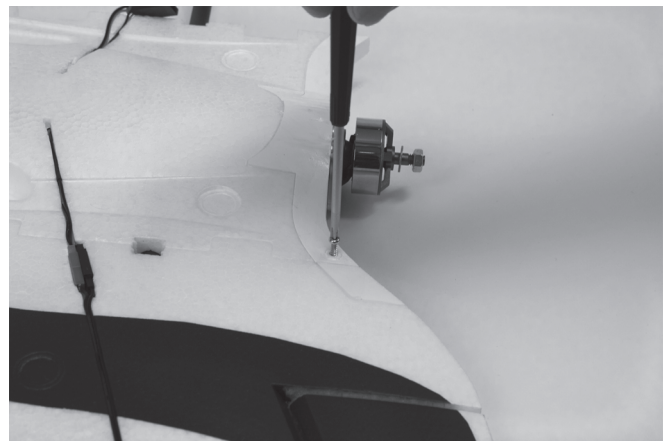
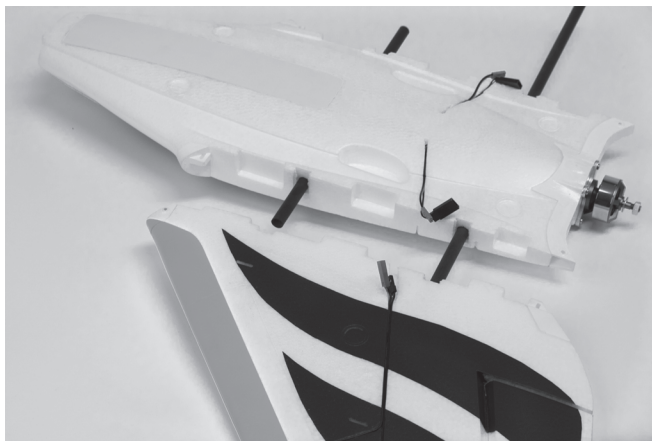

VERTICAL FIN INSTALLATION

Required Tools and Fasteners



(QTY 4)

#2 Phillips Screwdriver

(4) M3x15 Phillips head self-tapping screws

1. Locate the left and right vertical fins. Insert the vertical fin into the pocket in the main wing noting that the decals face the wing tips, and the servos orient toward the middle of the aircraft. Be careful not to pinch the servo wire.

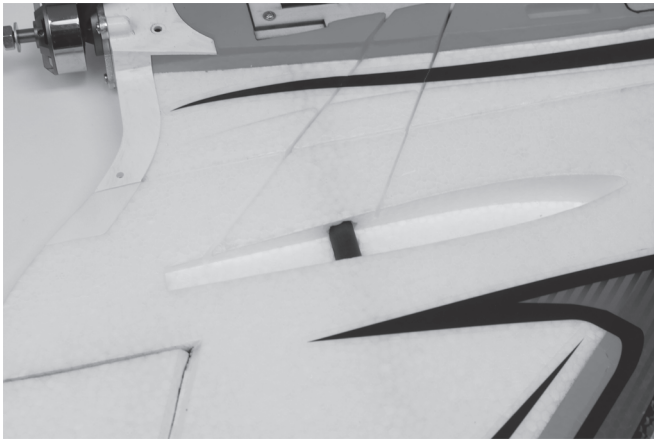

2. Secure a vertical fin in place from the bottom side of the wings by using a #2 Phillips screwdriver and (2) M3x15 Phillips self-tapping screws.

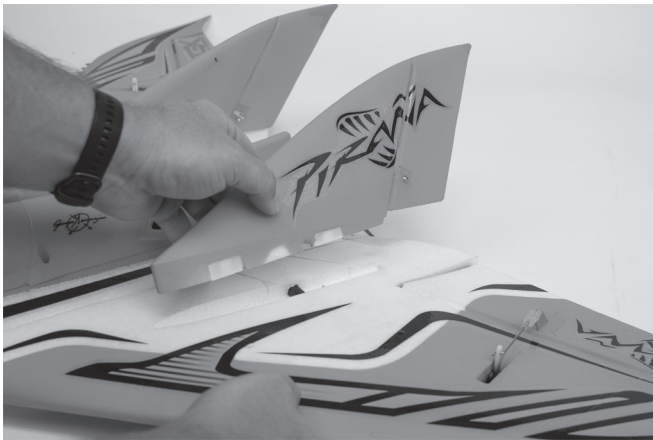

VERTICAL FIN INSTALLATION (CONTINUED)

3. Push the servo wire and Remote Receiver wire (if applicable) into the slot in the wing and fuselage. Connect each wire to their corresponding ports on Aura.

Left Rudder - S4
Right Rudder - S5
Remote Receiver - Mini Port B

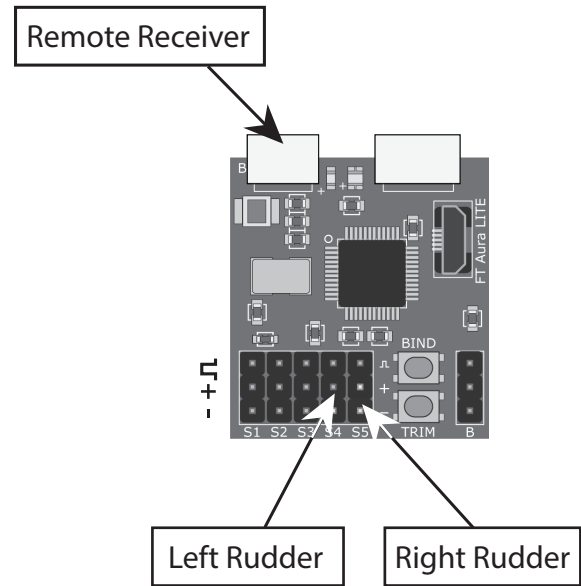
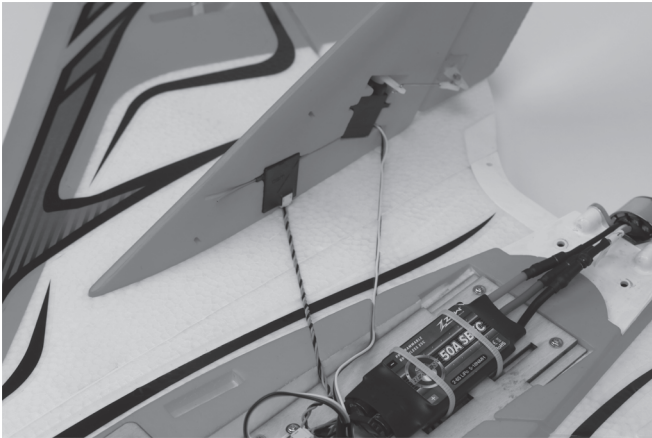

4. The rear access hatch can be re-installed at this time using the screws removed when mounting your receiver on page 10.

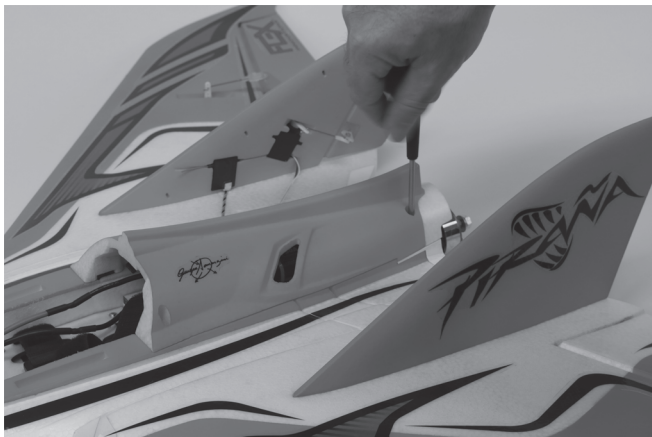

NOSE INSTALLATION

We recommend using clear tape in addition to the magnets too hold the removable nose to fuselage.

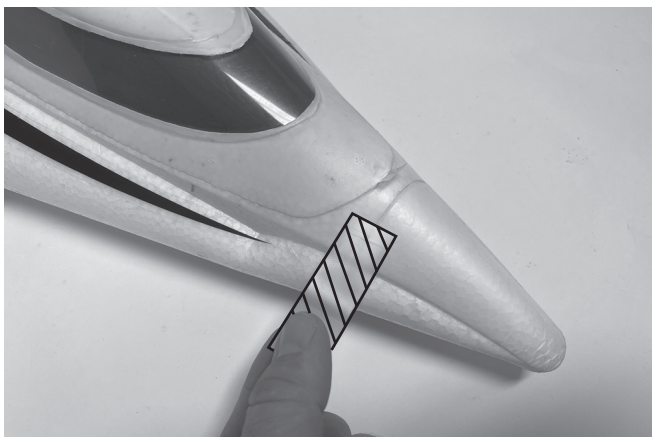

FPV Video Gear Installation (optional)

Required Tools and Fasteners



(QTY 2)

#1 Phillips Screwdriver

(2) M2x10 Phillips head self-tapping screws

Hot Glue Gun (for mounting camera)

NOTE: The video transmitter mount is an optional accessory (FPM417010), and can be purchased at flexinnovations.com or through your local Flex Innovations dealer.

1. Mount your video transmitter and antenna as desired. A hole is provided in the top of the fuselage for your FPV antenna. An optional video transmitter mount is available separately, and is secured to the main plywood tray using a #1 Phillips screwdriver and (2) M2 x 10 self-tapping screws that are provided with the mount. We used some hook and loop tape with a cable tie to secure the video transmitter in place.



FPV Video Gear (continued)

2. Due to the wide variety of video cameras available, we've provided a nose that may need to be modified slightly to fit your particular camera. An easy way to mount your video camera is to simply use a couple small dots of hot glue on the front and rear of the camera to secure it in place. Be sure to avoid getting glue on important lenses or electrical components.

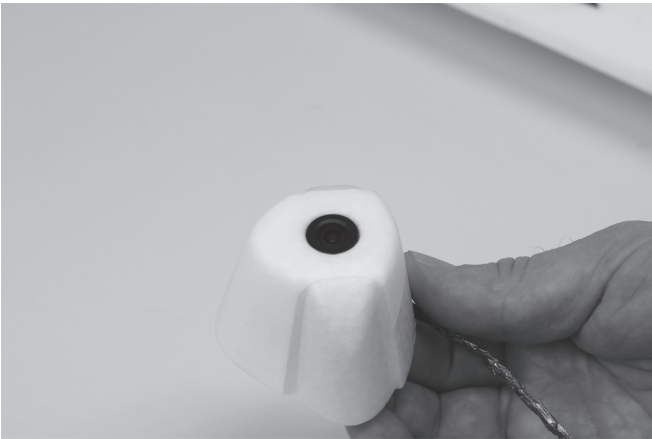
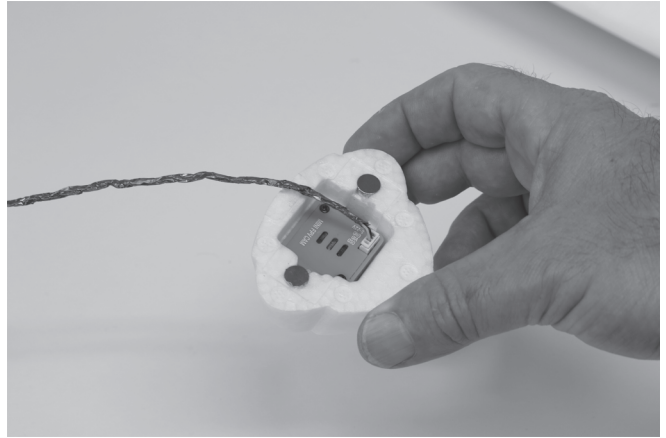
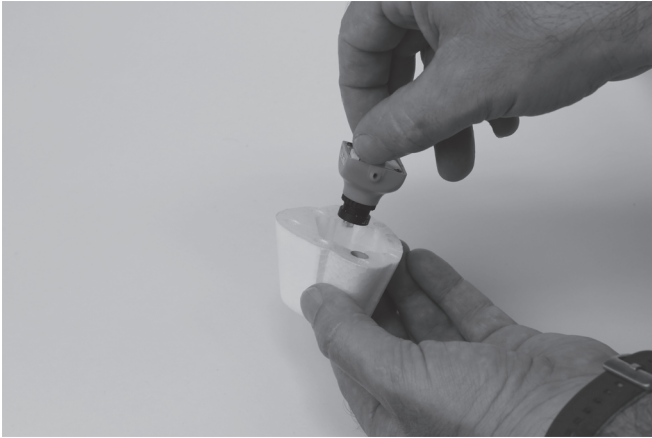

3. Route the camera wire through the slot in the front of the fuselage. Since camera sizes and weights vary, we recommend using regular clear tape to secure the FPV nose in place as the magnets may not be strong enough to support the weight of the camera.

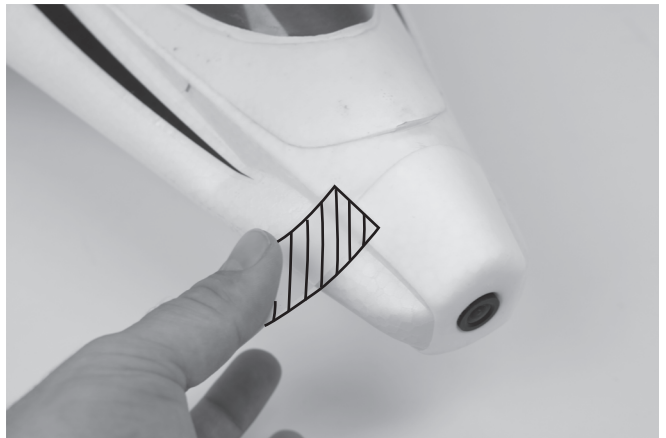
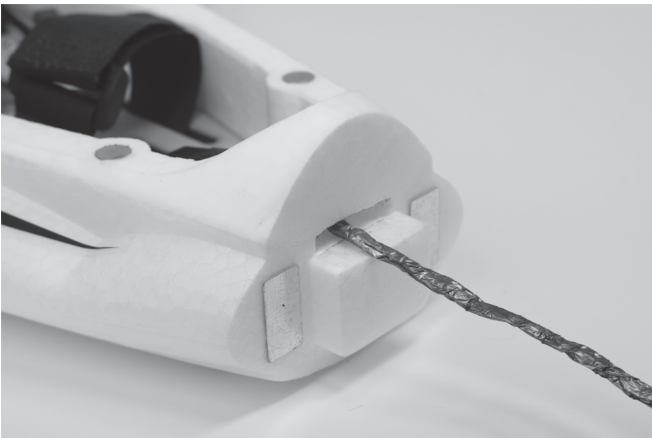

BATTERY INSTALLATION

1. Install the hook side of adhesive-backed hook and loop tape to the plywood battery tray in the fuselage, and the loop side to your battery.
2. Place the battery on the tray, and secure it in place with the provided hook and loop strap.



CONNECTING A BATTERY TO THE LED CONTROLLER

The LEDs on your aircraft are switchable via the transmitter and are designed to be powered by 12 volts (3S Li-Po) through the 6S JST-XH balance tab on the LED controller. By default, the LED controller is left unplugged from the receiver or Aura.

If the servo lead of the LED controller is not plugged into the Aura or a receiver (where it is not receiving a signal), the LEDs will default in the ON position, allowing the aircraft to be flown with the LEDs on using a basic 5-channel transmitter or serial receiver with no servo port or Satellite.

If you wish to switch your LEDs on and off from the transmitter, follow these simple steps:

NOTICE

YOU MUST USE A SERIAL RECEIVER WITH A WORKING CHANNEL 7 (AUXILIARY 2) PORT.

1. Plug the servo lead of the LED controller into an open channel on your receiver. We recommend channel 7.
2. Assign channel 7 (or the channel that you plugged the LED controller into) to a 2-position switch on your transmitter.
3. Verify the lights switch on and off when the assigned switch moves positions and the LEDs are powered. If you want the switch to work in the opposite direction, simply reverse the channel in your transmitter.

⚠ WARNING

THE LEDs DRAW CURRENT FROM ONLY 3 CELLS OF THE BATTERY POWERING THEM. IF USING A HIGHER CELL COUNT BATTERY FOR POWER, 3 OF THE CELLS WILL HAVE LOWER VOLTAGE THAN THE OTHERS AT THE END OF EACH FLIGHT. LEAVE EXCESS VOLTAGE IN THE BATTERY AT THE END OF EACH FLIGHT TO PREVENT THE OVER-DISCHARGING OF THE CELLS THAT POWER THE LEDs. YOU MUST BALANCE CHARGE YOUR BATTERIES AFTER EACH FLIGHT THE LED CONTROLLER IS POWERED BY ANYTHING OTHER THAN A 3 CELL BATTERY.

⚠ WARNING

DO NOT LEAVE THE BATTERY PLUGGED INTO THE LED CONTROLLER FOR EXTENDED PERIODS OF TIME. DOING SO CAN DAMAGE THE BATTERY.

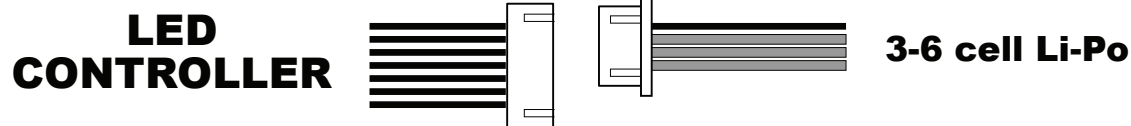

NOTE: Black wire is Negative (-), other wires are positive (+). Incorrect connection can result in failure of the LED controller and/or the LED strips.

PROPELLER INSTALLATION

Required Tools and Fasteners

Adjustable Wrench

1. Locate the propeller and propeller nut. Install the propeller on to the motor shaft with the convex side facing forward. Use an adjustable wrench to tighten the propeller nut.

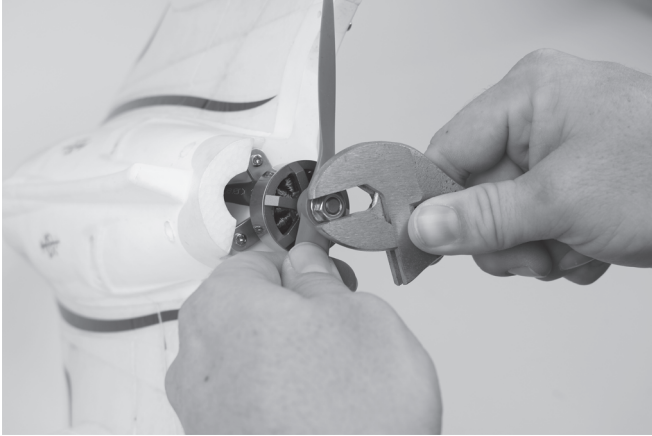

NOTE: The propeller nut is left-hand threaded. Turn the nut counter-clockwise to tighten, and clockwise to loosen.

CENTER OF GRAVITY VERIFICATION

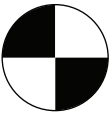

The center of gravity (CG) is measured from the trailing edge of the fuselage near the centerline of the aircraft.

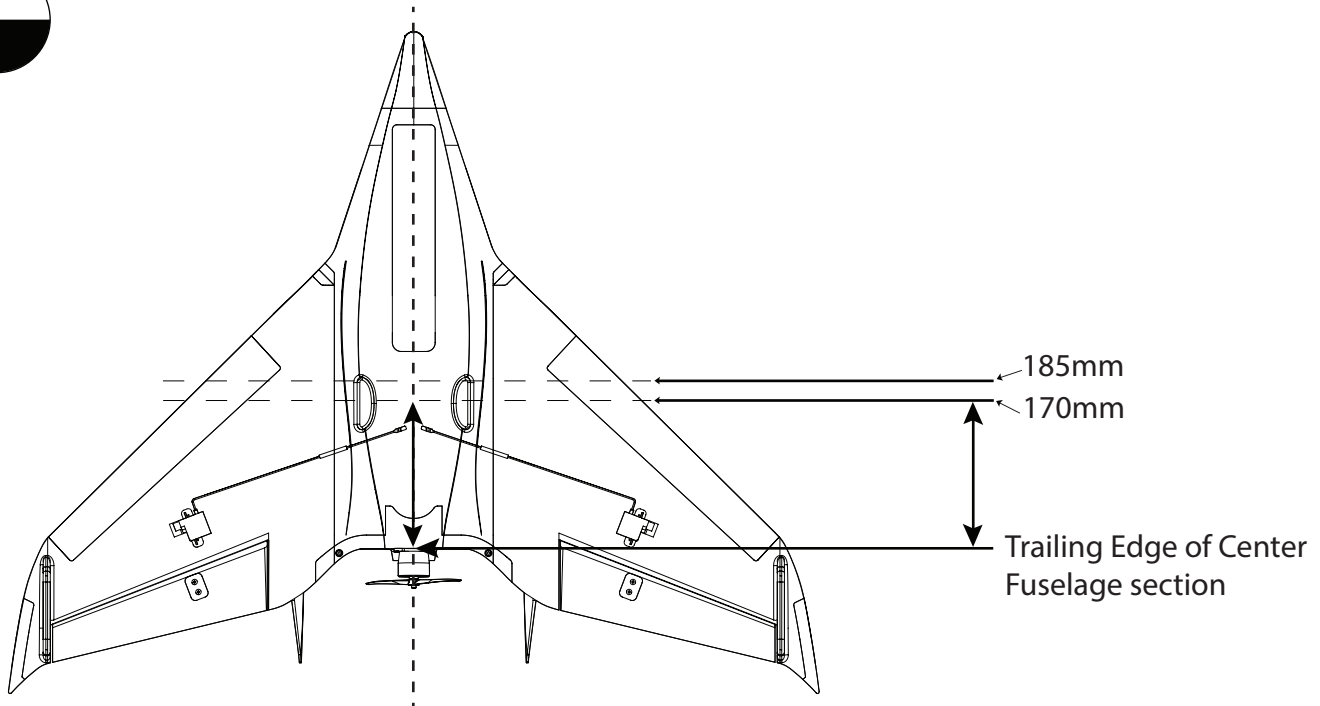

The CG range is from 170mm to 185mm (6-11/16-inches to 7-9/32 inches) when measured as depicted in the image above.





174mm (6-27/32-inches) is the optimum location for all types of flying.

Do not fly the Pirana with a CG further aft than 170mm (6-11/16-inches), as the aircraft can become unstable.

CONTROL DIRECTION TEST

Refer to the chart below to determine the proper control surface directions.

If controls are reversed, DO NOT REVERSE CONTROLS IN TRANSMITTER OR IN THE AURA CONFIG TOOL. Email us at support@flexinnovations.com for corrective action. Note that BOTH the Transmitter Control Direction Test AND the Flight Controller Sensor Direction Test **MUST BOTH BE PASSED! IF ONE DOES NOT PASS, DO NOT FLY!**

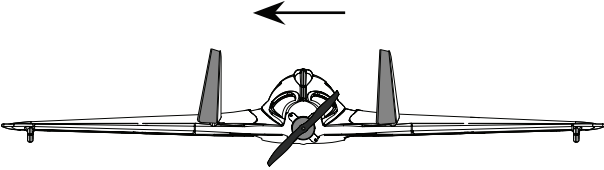
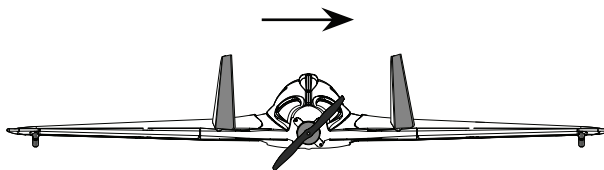
	Transmitter Command	Proper Control Surface Deflection
AILERON	Stick Left	
	Stick Right	
ELEVATOR	Stick Forward	
	Stick Aft	
RUDDER	Stick Left	
	Stick Right	

FLIGHT CONTROL SENSING DIRECTION TEST

Perform a test of the gyro system to verify the corrections made for a given movement are correct. If any of the tests do not result in the correct reaction from the airplane's gyro system, **DO NOT FLY THE AIRPLANE**, and contact us via email at support@flexinnovations.com.

The flight control system activates with RF broadcast. Perform these tests in Mode 3 (higher gain) for better visibility and then in Mode 2, and in any other modes that have gyro gains assigned. (By default, Mode 1 has no gain assigned). Control surface deflections are exaggerated in the drawings below for clarity. Please note, that the control surfaces will move **ONLY** when the aircraft is being **ROTATED**.

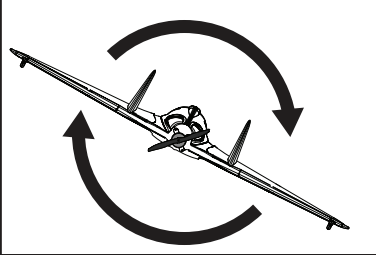
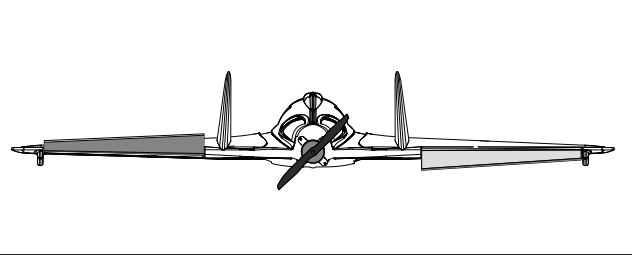
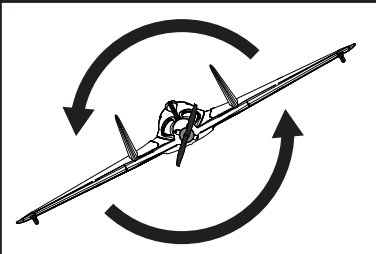
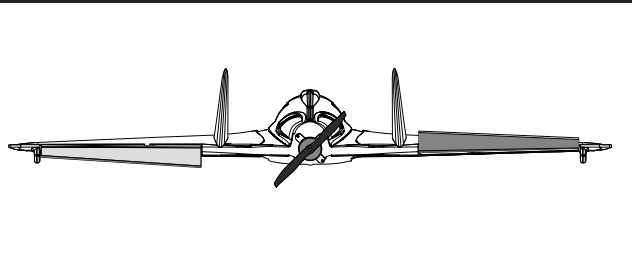
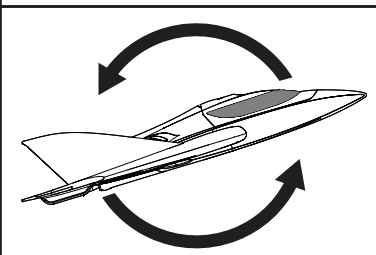
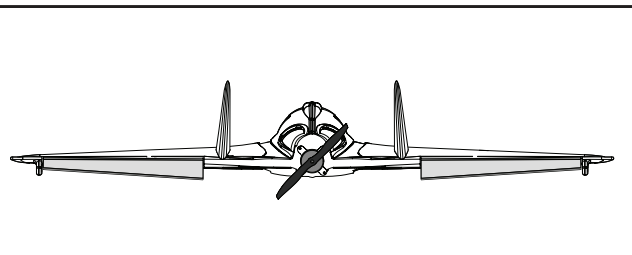
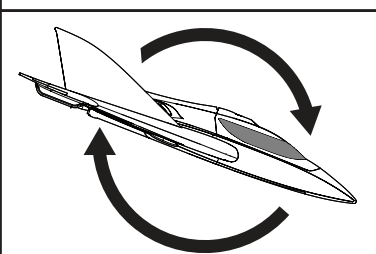
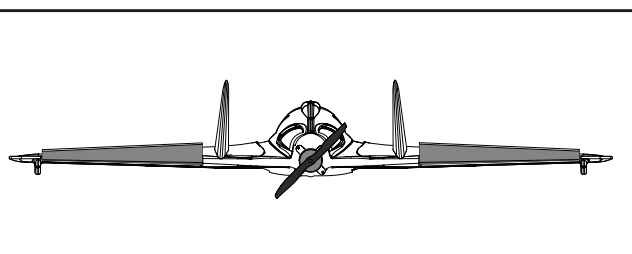
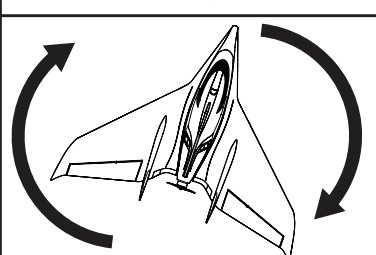
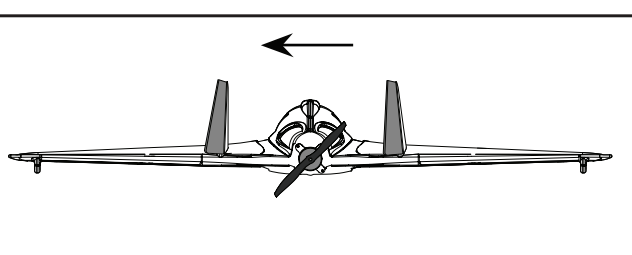
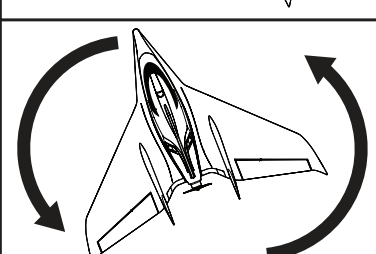
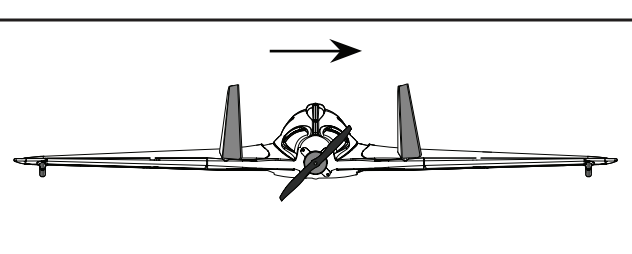
	Aircraft Movement	Proper Control Surface Deflection
AILERON		
		
ELEVATOR		
		
RUDDER		
		

PRE-FLIGHT CHECKLIST

To help ensure a successful first flight, as well as many flights after, perform a few simple pre-flight checks to be sure the aircraft is ready to fly.

1. Verify all control surfaces are properly hinged and are in good working order. Pinch a control surface between your thumb and fore finger and stabilize the wing with your other hand. Give the control surface a good pull away from the wing. The control surface should not come unhinged from the wing. Be sure to avoid over-stressing the part as an aggressive pull may cause the control surface to come unhinged even though it was hinged properly. If hinging is loose, **DO NOT FLY!** Apply thin CA to the loose side(s) of the hinged to re-secure.
2. Verify that all hardware and other aircraft parts are properly secured, including those connections that require blue thread lock. This includes hardware and parts installed by the factory.
3. Verify your battery is fully charged and in good condition. Avoid using batteries with swollen cells, or batteries that do not charge back to their full capacity.
4. Verify the C.G. is in the proper location and the battery is secured in place.
5. Ensure the Aura is on and functioning properly. Power on your transmitter, followed by the aircraft. Ensure the Aura is calibrated properly and receiving a valid radio source (solid orange+solid green LEDs).
6. Verify transmitter stick inputs result in the proper control surface movements (reference page 19) and that Aura flight modes work properly.
7. Verify aircraft movement results in proper Aura sensor corrections (reference page 20).
8. Verify the motor and ESC function properly. Point the aircraft in a safe direction. Hold the airframe firmly, smoothly advance the throttle to full and back to idle. Listen and watch for any odd or unusual behavior for the motor or speed controller.

LAUNCH ASSIST

Launch Assist makes hand launching your model a breeze! Launch Assist establishes a brisk climb rate while keeping the wings level and instantly returns control to the pilot once elevator or aileron inputs are made on the transmitter.

Stick positions to activate Launch Assist

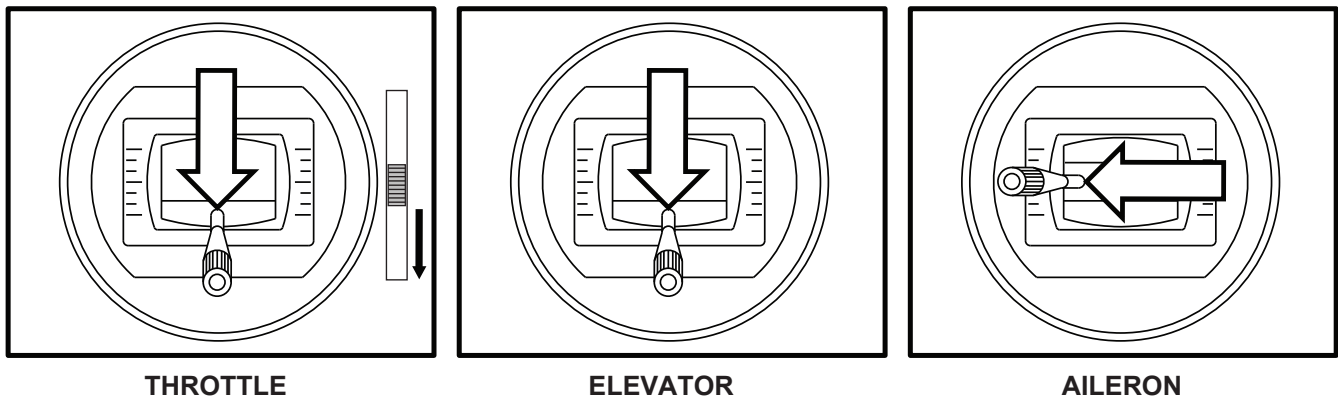

To Activate Launch Assist:

1. Power on the transmitter and the aircraft. Make sure the aircraft remains motionless for 8 seconds. With throttle stick and throttle trim low, **HOLD** full left aileron and full up elevator and rudder centered for 3 seconds. When Launch Assist is active, the Red LED on Aura will flash and the elevons will move to keep the wings level and command a climb.
2. Let the sticks return to center and proceed to hand launch the aircraft. Launch the aircraft with the motor off. Once the aircraft has left your hand, quickly move the throttle to full while being sure to keep all other sticks centered. **Do not hand-launch the aircraft over your shoulder under power, as serious injury can occur.**

To Deactivate Launch Assist:

- Simply move the aileron or elevator stick away from center and control will resume in the Flight Mode selected.
- Moving the throttle or rudder stick does not deactivate launch assist.

TRIMMING

The first several flights of your new Piraña should be dedicated to setup and trimming. Trimming your aircraft with the Aura is different than you would typically trim the aircraft without Aura. Transmitter trim or sub-trim will cause trim shifts when different flight modes are selected. To eliminate this trim shift, the model should be mechanically trimmed, or Aura “Quick Trim” may be used instead. You can only adjust the Level Assist trim setting by using Aura Quick Trim.

NOTE: It is important to first have the proper CG setting before finalizing your trim position as CG can have a large impact on how the aircraft trims. For proper CG information, please take a look at the Center of Gravity section of this manual.

Aura Quick Trim

The FT Aura 5 Lite features a Quick Trim Mode that eliminates the need for mechanical linkage adjustments during test flights. Aura will learn the trim values from your transmitter and apply them to the control surfaces after power up when enabling Quick Trim.

NOTE: Quick Trim may be repeated as needed for fine tuning, or if changes to the aircraft are made.

NOTE: Ensure Aileron, Elevator and Rudder transmitter sub-trims are zero before flying in order to allow Quick Trim to work properly.

Aura Quick Trim (3-Axis, Standard)

1. Fly the airplane in your preferred 3-Axis (Standard Controls) Flight Mode at 2/3 power. Trim the aircraft with the transmitter and land. **DO NOT CHANGE FLIGHT MODES.**
2. Open the battery hatch so that you have access to the Aura. Press and hold the trim button to enter Quick Trim mode. This is indicated by a blue flashing LED.
3. Press and hold the trim button again to save the trims. This is indicated by a fast flashing blue LED.
4. Press and hold the trim button again to restart the Aura with the new trims.
5. Cycle the power on the aircraft.

Aura Quick Trim (6-Axis, Level Assist)

1. Fly the airplane in the 6-Axis (Level Assist) Flight Mode at 2/3 power. Use the trim on the transmitter to level the aircraft in both pitch and roll. Land and **DO NOT CHANGE FLIGHT MODES.**
2. Open the battery hatch so that you have access to the Aura. Press and hold the trim button to enter Quick Trim mode. This is indicated by a blue flashing LED.
3. Press and hold the trim button again to save the trims. This is indicated by a fast flashing blue LED.
4. Press and hold the trim button again to restart the Aura with the new trims.
5. Cycle the power on the aircraft.

NOTE: For newer pilots, Level Assist commands a slight pitch up while at full power, and an easy descent or pitch down at idle. Do NOT trim the aircraft in Level Assist at full-power, as it will affect these settings.

AURA QUICK CHANGE MODE

The FT Aura 5 Lite in the Piraña has two optional configurations that can be selected without the use of a PC; Level Assist and Air Brakes

Level Assist

Level Assist prevents the aircraft from being over controlled by limiting pitch and bank angles and prevents the aircraft from rotating upside down. It also self-levels the aircraft when the sticks are returned to neutral. Activating Level Assist replaces Flight Mode 1 in the standard setup.

Air Brakes

Air Brakes are when both rudders deflect in opposite directions toward the center of the aircraft, which causes drag and slows the aircraft down. The FT Aura 5 Lite uses channel 6 from your transmitter as an on/off switch to control the airbrakes. While active, the airbrakes are also mixed to the throttle so that simply advancing the throttle will return the rudders to neutral.

Assign channel 6 to a 2-position switch in your transmitter if you wish to activate the Air Brakes.

To enter Quick Change Mode, use the following steps:

1. Power ON your transmitter and the aircraft, and verify you are getting a valid signal from the receiver to the Aura. You should see a solid orange and solid green LED visible on the Aura.
2. Press and hold **both BIND and TRIM buttons** to enter Quick Change Mode. Quick Change Mode is indicated by fast a flashing green LEDs.

After entering Quick Change Mode you can:

1. Check Sensor Directions

- Roll the aircraft right, to confirm the elevons move in a manner to counter the direction of movement.
- Pitch the nose up, to confirm the elevons move in a manner to counter the direction of movement.
- Yaw the aircraft nose right, to confirm the rudder moves in a manner to counter the direction of movement.

Note: These movements are exaggerated for clarity while in Quick Change mode, and do not represent their actual movements in flight.

2. Change Flight Mode 1 between Standard (3-Axis) and Level Assist (6-Axis)

- Press and HOLD the BIND button until you see a solid blue LED.
- The servos will cycle back and forth TWICE to confirm Flight Mode 1 has changed to Level Assist.

You can repeat button presses to switch back and forth as many times as necessary.

3. Change Air Brakes from Inactive, to Active

- Press and HOLD the TRIM button until you see a solid RED LED.
- The servos will cycle to confirm the change has been stored.

To save your selections and exit Quick Change Mode:

- Press and HOLD both the BIND and the TRIM buttons again to exit Quick Change Mode and Restart the Aura. Your changes have now been stored.

Note: Futaba users who wish to use airbrakes must visit our Wiki site for information on how to configure airbrake setup.

wiki.flexinnovations.com/wiki/Pirana

Selecting a Flying Site

Selecting a flying site is critical to a successful flight. Airplanes require a lot more room than other R/C products, therefore, a neighborhood or parking lot is less than ideal. A large open field with short grass and generous overfly area are the best candidates. If no AMA field is available in your area. Know your overfly area-ensure that there are no houses, playgrounds, or other buildings that may be damaged if the airplane were to crash.



Hand Launching

Activate Launch Assist. Grab the Piraña using the small reliefs in the bottom of the fuselage of the aircraft, or at the leading edge of the wing, approximately halfway to the wing tip. If using the reliefs in the bottom of the fuselage, keep the throttle OFF during launch to avoid injury. Take a few brisk strides forward and launch the aircraft in a level or slightly nose-up attitude. Once the aircraft leaves your hand, advance the throttle to full power. Be careful to avoid bumping your aileron or elevator sticks. Once the aircraft has climbed to a comfortable altitude, simply move the ailerons or elevator to disable Launch Assist and continue with the flight.

Flying

Trim the aircraft based on our recommendations on page 22 of this instruction manual, being sure to keep the aircraft in the same Flight Mode that you trimmed it in. Try some basic maneuvers and slowly progress into the airplane's flight envelope as you become more comfortable with the aircraft's flight qualities and perfect your setup. At a safe altitude, try other flight modes as desired. Note: If at any time, such as after gain adjustments, you experience unexpected control system inputs or oscillations, switch to Mode 1 (gyro off), land and troubleshoot the issue.

Landing

Be mindful of your flight time and allow adequate battery reserve for a couple of go-arounds, if necessary, on the first few flights. Select a landing site for belly landing, such as a grass field. Select Mode 2 and slow the aircraft to align into the wind and with your landing zone. The airplane should descend smoothly in this configuration with proper airspeed. Once you are close to the ground, gradually close the throttle fully and begin to smoothly apply up elevator as required to arrest descent and the airplane should gently touch down with the nose slightly high.

AIRCRAFT TROUBLESHOOTING GUIDE

Should you encounter any abnormal situations with your Piraña, refer to the matrix below to determine the probable cause and a recommended solution for the action.

If the required solution does not rectify the problem, please contact product support for further assistance.

DISCREPANCY	PROBABLE CAUSE	RECOMMENDED SOLUTION
Motor nonresponsive (no ESC initialization tones audible).	Throttle not at idle and/or throttle trim too high	Lower throttle stick and trim completely. If problem persists, ensure that the sub trim and travel adjust are properly set in the transmitter's programming.
	Throttle channel is reversed	Reverse throttle channel in transmitter programming
	Motor disconnected from ESC	Ensure plugs are fully seated. Check battery and/or plugs for damage and replace any damaged components found - DO NOT ATTEMPT REPAIR
Series of tones are heard from the motor	Throttle is slightly open when battery plugged in causing the ESC to go into programming mode.	Make sure the throttle stick and throttle trim are all the way down.
Motor turns in the wrong direction	The three motor wires are connected incorrectly to the ESC	Swap any TWO motor wires.
Reduced flight time or aircraft underpowered	Flight battery not fully charged	Ensure battery is fully charged prior to installing in aircraft
	Propeller installed backwards	Install propeller so that convex side faces forward
	Flight battery damaged	Remove battery from service completely and replace with a different battery
	Ambient temperature is too cold	Ensure battery packs are adequately warm (70°F/21°C) before flight
	Battery capacity too small for intended use	Replace battery with one of proper capacity and discharge capacity (C rating)
	ESC reaching preset LVC (low-voltage cutoff)	Recharge flight battery or reduce flight time
	Battery is too weak or damaged	Check battery's physical condition, check battery voltages after charge
Excessive propeller noise and/or vibration	Battery's discharge rating may be too small	Replace battery with one with higher 'C' rating
	Damaged propeller, collet, or motor	Replace damaged components - DO NOT ATTEMPT REPAIR
	Propeller is not balanced	Balance or replace the propeller
	Propeller nut is loose	Tighten propeller nut with appropriate-sized wrench
Control surfaces nonresponsive	Airframe or control linkage system damage	Examine airframe for damage, repair as required; inspect control linkage system (servo, pushrod, control horn) for damaged components and replace as required
	Wire damaged or connector loose	Examine wires and connections, replace as necessary
	Transmitter bound incorrectly, incorrect active model memory, incorrect Aura data input configuration, incorrect Aura transmitter settings	Consult radio manual for proper binding and model selection instructions
	Battery voltage too low	Use volt meter to check battery; recharge or replace as necessary
	Battery disconnected from ESC	Check that the EC3 plugs are fully seated
	BEC (battery elimination circuit) damaged	Replace ESC - DO NOT ATTEMPT REPAIR
Failed control direction test	Damaged Servo	Replace Servo - DO NOT ATTEMPT REPAIR
	Incorrect Aura 5 or Transmitter Setting - DO NOT FLY!	Reference transmitter and receiver sections of this manual. If no solution found, contact customer support at support@flexinnovations.com
Controls reversed	FT Aura 5 LITE or transmitter settings incorrect	Refer to control surface direction chart and transmitter setup; adjust appropriate settings as required. Check Piraña and Aura wiki web pages for additional information. Contact customer support at support@flexinnovations.com
Control surface oscillation	Exceeding maximum airspeed for configuration	Reduce airspeed
	Gains too high for aircraft/flight configuration	Refer to FT Aura 5 Lite manual to decrease desired control surface gain
	Propeller/spinner not balanced	Balance or replace propeller
	Motor vibration	Inspect motor mounting bolts and re-tighten as necessary
	Loose FT Aura 5 Lite mounting	Re-align and secure the FT Aura 5 Lite to the aircraft
	Control linkage slop	Examine control system and repair or replace work components
	Improper transmitter setup	Refer to FT Aura 5 Lite manual to correctly configure transmitter
	Damaged propeller	Replace damaged component- DO NOT ATTEMPT REPAIR
Improperly set master gain	Ensure master gain is set for proper gain value	
Trim changes between flight modes	Trims are not properly zeroed	Readjust control linkage and re-center trims in radio
	Transmitter sub-trim is not properly zeroed	Remove sub-trim; adjust the servo arm or clevis to achieve proper geometry
	Transmitter is not properly calibrated (aileron/elevator/rudder are not neutral with sticks centered; reference transmitter monitor)	Calibrate transmitter (reference manufacturer's instructions, or return to manufacturer for calibration)
Launch assist not engaging	Needs additional time to arm.	Rest airplane on a flat surface and be sure to not move it for 8 seconds.
	Trims not set properly	Keep aileron, elevator, and rudder trims centered, and throttle trim fully lowered. Use Quick Trim as needed. (See page 22)

AIRFRAME REPAIRS

The Piraña is molded from durable EPO foam and is repairable with most adhesives. Similar to building and repairing wood or composite airplanes, the correct glue for a given application is critical to the repair holding and not breaking again. For major repairs, such as a broken fuselage, epoxy is preferred because it allows time to correct any misalignment. For smaller repairs, such as cracked control surface or small chunk of material missing from the airframe, regular CA is very effective. The use of odorless (foam safe) CA is not recommended on EPO foam aircraft, such as the Piraña, because it is weaker than standard CA and takes a longer period of time to cure and the bond tends to be weaker.

NOTE: Avoid the use of CA accelerant in repairs. It can damage paint and will weaken the bond of the glue. If CA accelerant is used, be mindful of the locations of CA to prevent premature bonding of parts, or bonding a hand or clamp to the airframe.

If a part is damaged too badly to be repaired, please refer to the front of the manual for a complete listing of spare airframe parts.

NOTICE: If a crash is imminent, fully reduce the throttle to prevent further damage to the power system and reduce energy to lessen impact damage.

BE ADVISED THAT CRASH DAMAGE IS NOT COVERED UNDER ANY PRODUCT WARRANTY.

Avoid keeping the aircraft in direct sunlight when not flying. Excessive heat and UV exposure can damage the airplanes structure and can also permanently discolor decals.

REPLACING SERVOS

Required Tools

#1 Phillips Screwdriver

1. Unplug the servo from the receiver.
2. Unscrew the mounting screw located at each end of the servo and remove.
3. Unscrew the servo arm from the servo and remove the servo arm.

NOTE: The rudder servos are glued into the vertical fin, (only around the perimeter of the servo) so a sharp #11 Xacto knife will be required to cut the glue around the servo to remove the servo from the fin.

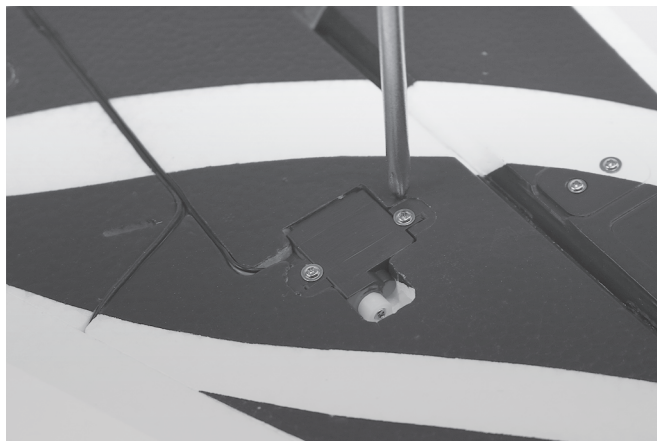

SERVICING THE POWER SYSTEM

Required Tools and Fasteners:

#1 Phillips Screwdriver, 13mm box wrench

1. Remove the propeller from the motor.
2. Remove the front and rear hatches
3. Remove the (4) bolts holding the motor to the firewall using a #1 Phillips screwdriver. Disconnect the motor from the ESC.
4. To remove ESC, simply unplug it's lead from the receiver or Aura and the output leads from the motor.
5. If you discover the motor shaft is rotating in the incorrect direction after replacing the motor, simply swap one of the three wires going to the motor and it will reverse the shaft rotation.

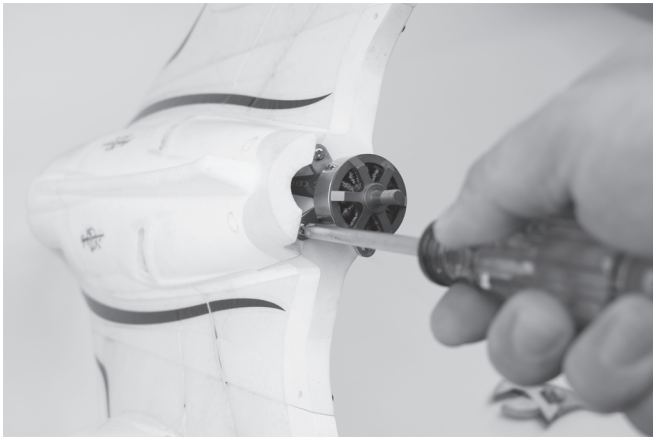

AMA SAFETY CODE

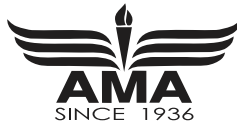

When flying your aircraft, we recommend following the guidelines set by the Academy of Model Aeronautics (AMA). You can find their safety handbooks as well as more information on the AMA at their website, located at the address below:

www.modelaircraft.org

LIMITED WARRANTY

Warranty Coverage

Flex Innovations, LLC. and its authorized resellers ("Flex") warrant to the original purchaser that the product purchased (the "Product") it will be free from defects in materials and workmanship at the date of purchase.

Outside of Coverage

This warranty is not transferable and does not cover:

- (a) Products with more than 45 days after purchased date.
- (b) Damage due to acts of God, accident, misuse, abuse, negligence, commercial use, or due to improper use, installation, operation or maintenance
- (c) Modification of or to any part of the Product.
- (d) Product not compliant with applicable technical regulations.
- (e) Shipping damage.
- (f) Cosmetic damage

OTHER THAN THE EXPRESS WARRANTY ABOVE, FLEX MAKES NO OTHER WARRANTY OR REPRESENTATION, AND HEREBY DISCLAIMS ANY AND ALL IMPLIED WARRANTIES, INCLUDING, WITHOUT LIMITATION, THE IMPLIED WARRANTIES OF NONINFRINGEMENT, MERCHANTABILITY AND FITNESS FOR A PARTICULAR PURPOSE. THE PURCHASER ACKNOWLEDGES THAT THEY ALONE HAVE DETERMINED THAT THE PRODUCT WILL SUITABLY MEET THE REQUIREMENTS OF THE PURCHASER'S INTENDED USE.

Purchaser's Solution

Flex's sole obligation and purchaser's sole and exclusive remedy shall be that Flex will, at its option, either (i) service, or (ii) replace, any Product determined by Flex to be defective. Flex reserves the right to inspect any and all Product(s) involved in a warranty claim. Service or replacement decisions are at the sole discretion of Flex. Proof of purchase is required for all warranty claims. **SERVICE OR REPLACEMENT AS PROVIDED UNDER THIS WARRANTY IS THE PURCHASER'S SOLE AND EXCLUSIVE REMEDY.**

Limitation of Liability

FLEX SHALL NOT BE LIABLE FOR SPECIAL, INDIRECT, INCIDENTAL OR CONSEQUENTIAL DAMAGES, LOSS OF PROFITS OR PRODUCTION OR COMMERCIAL LOSS IN ANY WAY, REGARDLESS OF WHETHER SUCH CLAIM IS BASED IN CONTRACT, WARRANTY, TORT, NEGLIGENCE, STRICT LIABILITY OR ANY OTHER THEORY OF LIABILITY, EVEN IF FLEX HAS BEEN ADVISED OF THE POSSIBILITY OF SUCH DAMAGES.

Further, in no event shall the liability of Flex exceed the individual price of the Product on which liability is asserted. As Flex has no control over use, setup, assembly, modification or misuse, no liability shall be assumed nor accepted for any resulting damage or injury. By the act of use, setup or assembly, the user accepts all resulting liability. If you as the purchaser or user are not prepared to accept the liability associated with the use of the Product, purchaser is advised to return the Product immediately in new and unused condition to the place of purchase.

Law

These terms are governed by Florida law (without regard to conflict of law principals). This warranty gives you specific legal rights, and you may also have other rights which vary from state to state. **FLEX RESERVES THE RIGHT TO MODIFY THIS WARRANTY AT ANY TIME WITHOUT PRIOR NOTICE.**

Questions & Assistance

Visit <https://www.flexinnovations.com/flex-dealers/> for customer support in your region.

Inspection or Services

If this Product needs to be inspected or serviced and is compliant in the region you live and use the Product in, please contact your regional Flex authorized reseller. Pack the Product securely using a shipping carton. Please note that original boxes needs to be included, but are not designed to withstand the rigors of shipping without additional protection. Ship via a carrier that provides tracking and insurance for lost or damaged parcels, as Flex is not responsible for merchandise until it arrives and is accepted at our facility.

Warranty Requirements

For Warranty consideration, you must include your original sales receipt verifying the proof of purchase date. Provided warranty conditions have been met, your Product will be replaced free of charge. Shipping charges are as follows: to Flex paid by customer, Flex out it is paid by Flex. Service or replacement decisions are at the sole discretion of Flex.

COMPLIANCE INFORMATION FOR THE EUROPEAN UNION

 **Declaration of Conformity** (In accordance with ISO/IEC 17050-1)

Product(s): Piraña Super PNP
Item Number(s): FPM4170A, FPM4170B

Piraña Super PNP (Orange)
Piraña Super PNP (Yellow)

The object of declaration described above is in conformity with the requirements of the specifications listed below, following the provisions of the EMC Directive 2004/108/EC.

EN 55022: 2010+AC: 2011
EN 55024: 2010
EN 61000-3-2: 2006+A2:2009
EN 61000-3-3: 2013

EN 61000-6-3: 2007/A1:2011
EN 61000-6-1: 2007



Instructions for disposal of WEEE by users in the European Union

This product must not be disposed of with other waste. Instead, it is the user's responsibility to dispose of their waste equipment by handing it over to a designated collections point for the recycling of waste and electronic equipment. The separate collection and recycling of your waste equipment at the time of disposal will help to conserve natural resources and ensure that it is recycled in a manner that protects human health and the environment. For more information about where to drop off your waste equipment for recycling, please contact your local city office, your household waste disposal service or where you purchased the product.



© 2020 Flex Innovations, LLC.

Potenza™ is a trademark trademark of Flex Innovations, LLC.

DSM®, DSM2™, and DSMX™ are trademarks of Horizon Hobby, Inc.

Futaba is a registered trademark of Futaba Denshi Kogyo Kabushiki Kaisha Corporation of Japan.

Jeti, UDI, and Jeti Model are trademarks or registered trademarks of Jelen, Ing. Stanislav of Czech Republic

HoTT is a registered trademark of SJ, Inc.