

Your Futaba R7208SB/R7308SB programming can be updated easily online. When functions are improved, the update file can be downloaded from our website.

For more information, check out web site for FAQ regarding updating this product.

*The display screen is an example. The screen depends on the PC.

Required for update

CIU-3

*CIU-2 cannot be used.



CGY750/GY701/GY520
Extensions

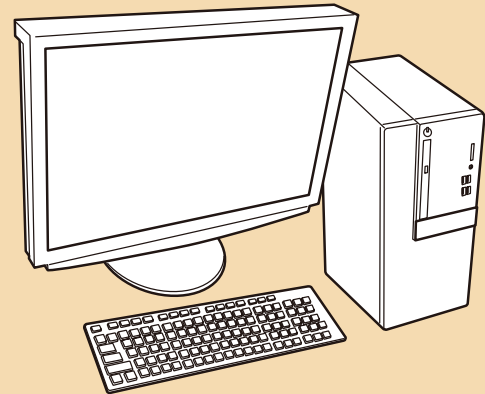

PC
(Access is possible by the web)

Preparations

1. Install the driver for the CIU-3 onto your PC.

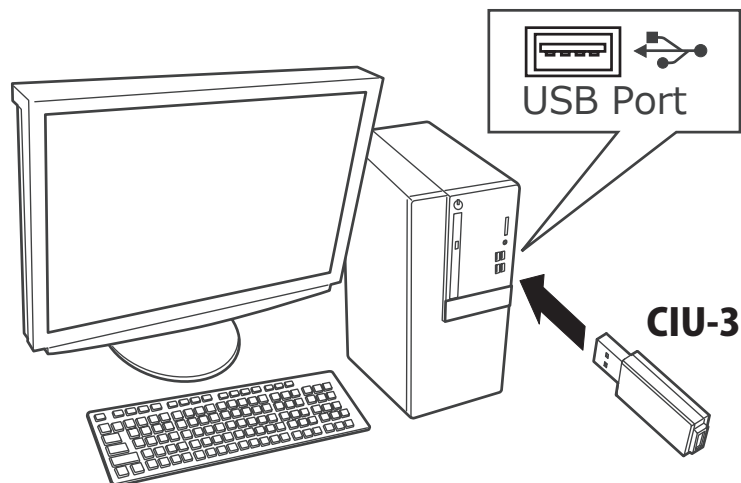

- ◆ When the **CIU-3** is first connected to the PC, once the CIU-3 is connected to the PC, download the recommended driver software Using Windows Vista, the "Found New Hardware Wizard" window appears on the screen. Click "Locate and install driver software".
- ◆ Refer to the manual of the CIU-3 for further information.

Updating procedure

1. Download the zip file of the update data from our website or your local distributor's website.

<http://www.rc.futaba.co.jp>

<https://futabausa.com>

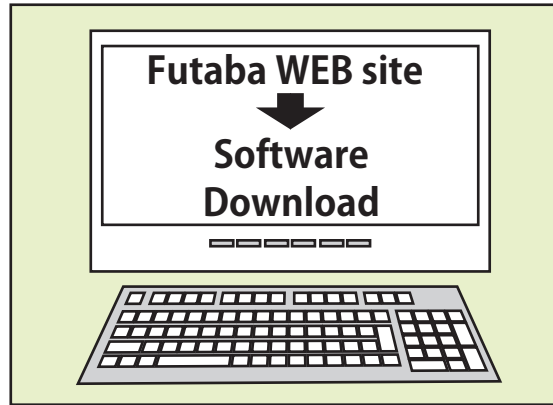

2. Extract the zip file on your computer.

*The software of R7208SB and R7308SB is common.

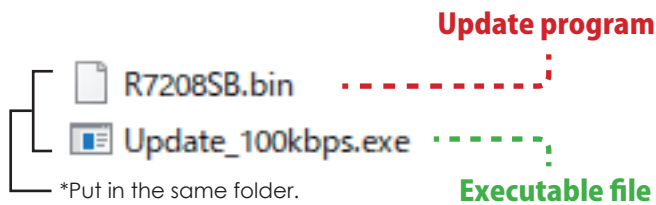

3. Connect as shown in the figure.

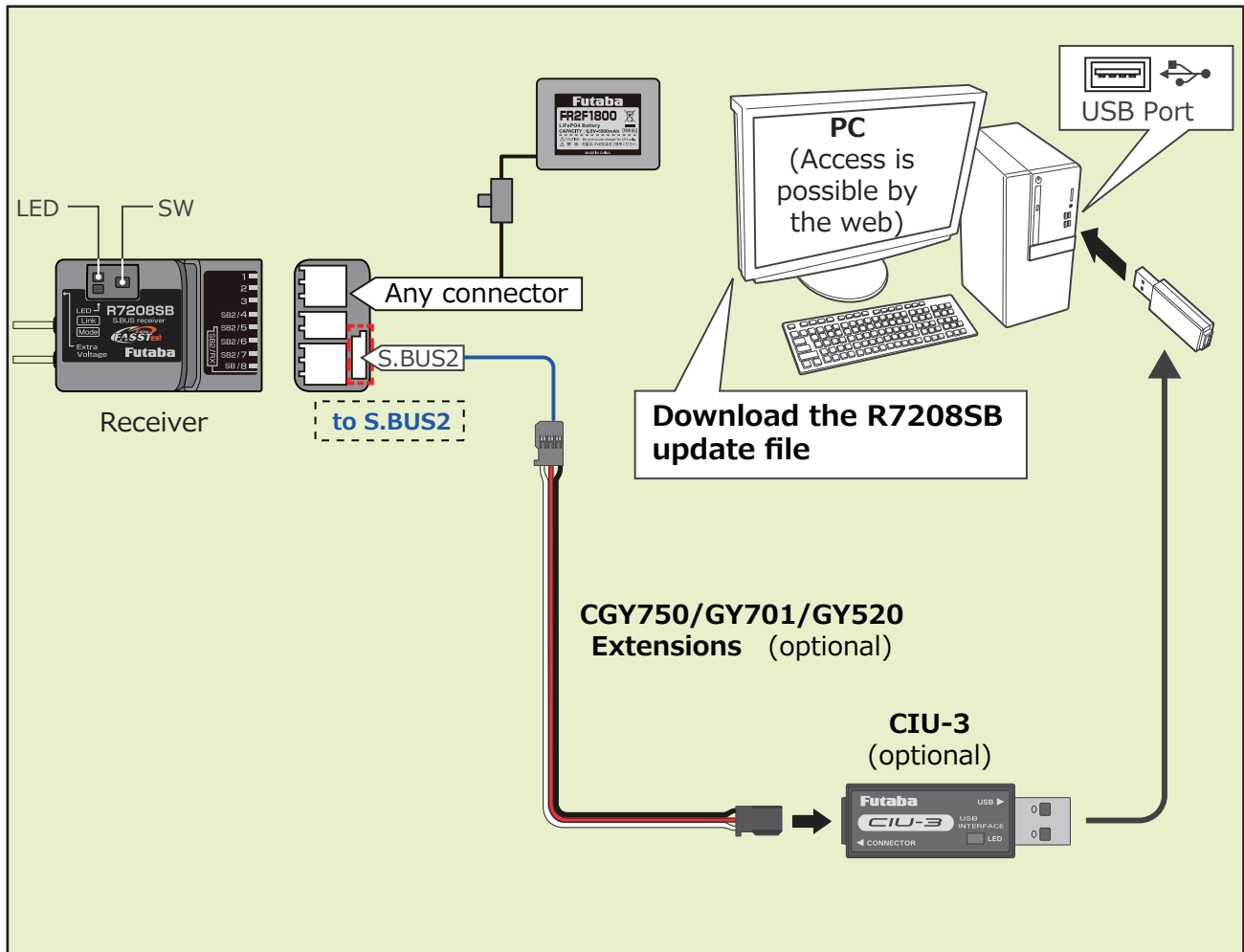

4. Turn on the receiver power while pressing down the switch.

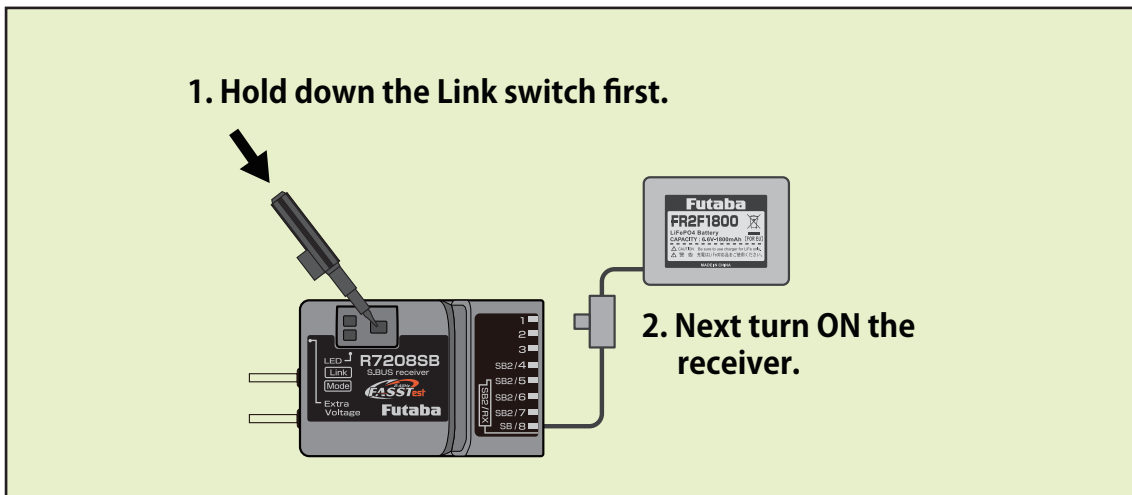

5. LED flash red once, release the switch.

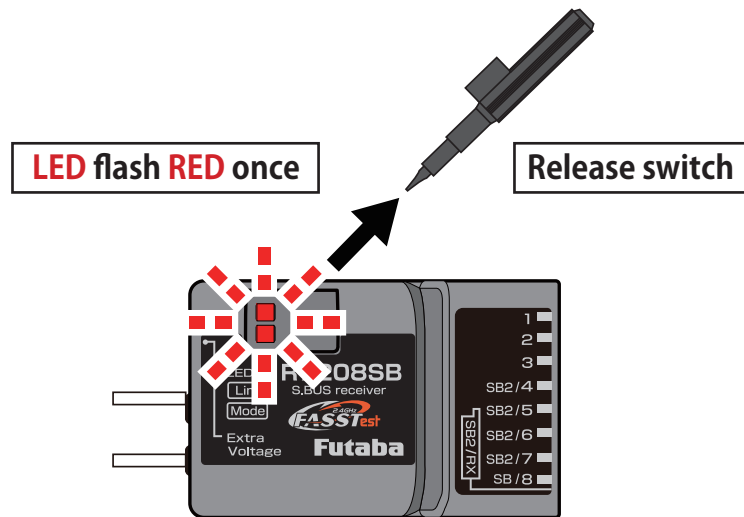

6. Press the switch again.

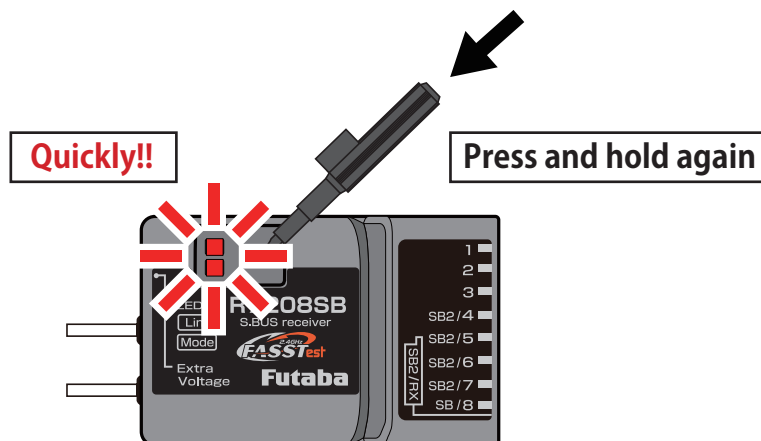

7. Release the switch when the solid orange.

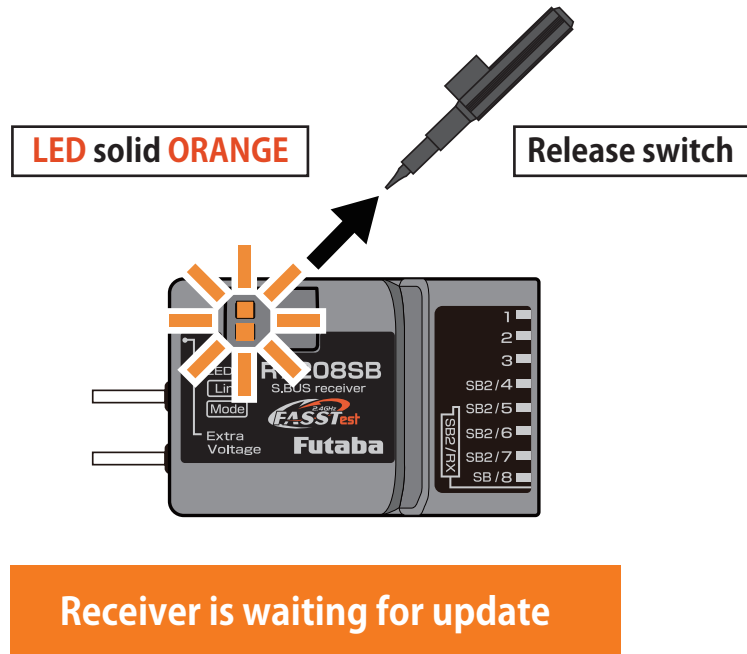

8. Execute the update file copied to the PC.

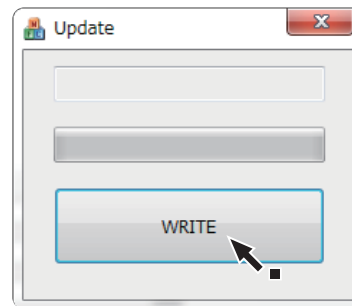

Write

9. Operate the PC update. (The receiver should keep orange on.)

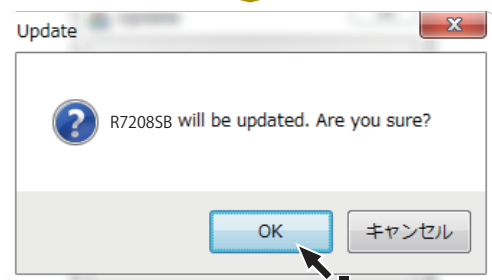

OK

Wait

Don't turn off the power !

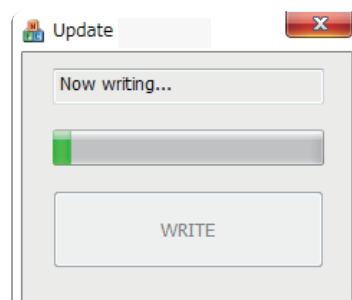

Flickers **GREEN** during update

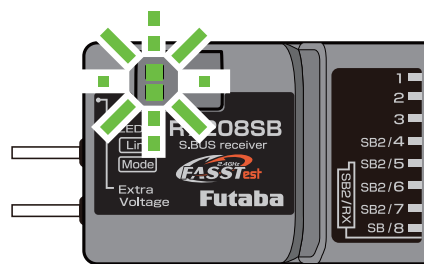

LED solid **GREEN**

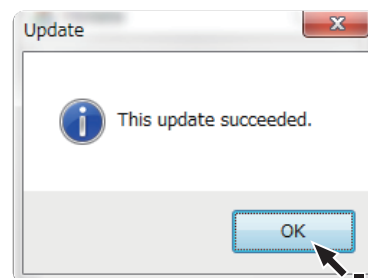
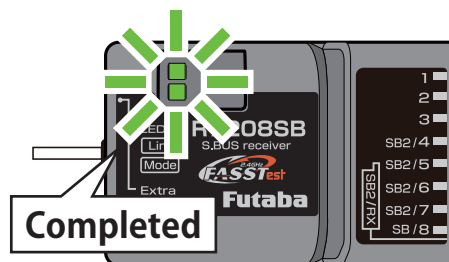

10. The **GREEN LED** on the R7208SB/R7308SB lights up when the update is complete. A completion message box will appear on your PC. Click OK.

11. Turn off the power switch of your R7208SB/R7308SB and remove the CIU-3.

12. Be sure to check the each function before use.

V1.3 UPDATE

- Fixed the bug that F/S does not work when receiving error when FASSTest12ch telemetry OFF mode is used.
- Fixed a bug that the RPM display of the telemetry RPM sensor (SBS-01RM/RO/RB) did not become 0.
- Fixed the malfunction of the battery fail-safe setting CH when the battery fail-safe state occurred when using R9001SB and dual RX link mode.
- Fixed the operation response when using dual RX link mode with R9001SB in FASSTest12ch mode.

V1.1 UPDATE

- Fixed an issue where some transmitters could not be linked.

Back of receiver

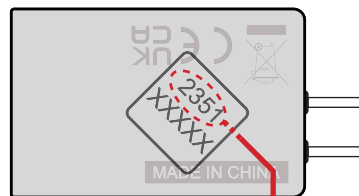

Receivers whose serial number is 2351 or earlier are eligible. Receivers from 2352 onwards do not need to be updated.