

RV-8

DAY & NIGHT VERSIONS

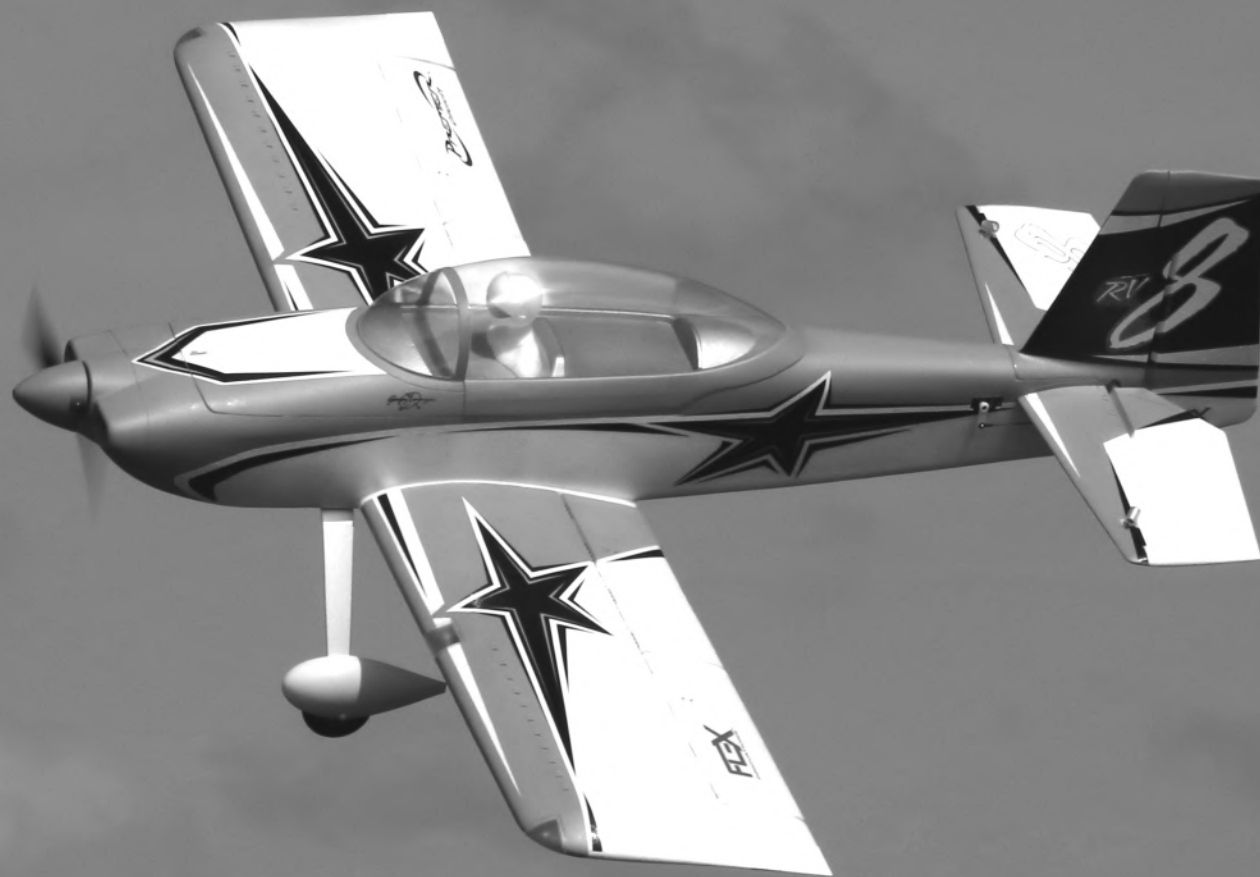

SUPER
PNP
Instruction Manual

DESIGNED BY:

Giuseppe Tompazini



BEFORE CONTINUING WITH THIS INSTRUCTION MANUAL OR ASSEMBLY OF YOUR AIRCRAFT, PLEASE VISIT OUR WIKI SUPPORT SITE FOR THE LATEST PRODUCT UPDATES, FEATURE CHANGES, MANUAL ADDENDUMS AND FIRMWARE CHANGES FOR BOTH YOUR AIRCRAFT AND THE INSTALLED AURA 8 ADVANCED FLIGHT CONTROL SYSTEM.

**wiki.flexinnovations.com/wiki/RV8
wiki.flexinnovations.com/wiki/Aura**

TABLE OF CONTENTS

Introduction.....	2	Horizontal Stabilizer Installation	16
Box Contents	2	Rudder and Elevator Linkage Installation.....	17, 18
Specifications	3	Main Wing Installation	19
Completion Items	3	Transmitter Control Direction Test	20
Battery Charging Guidelines	3	Flight Control Sensing Direction Test	21
Special Language Definitions	4	Motor And Propeller Installation	22
Important Information Regarding Warranty	4	Propeller and Spinner Installation.....	23
Safety Warnings and Precautions	4	Center of Gravity Verification	24
Low Voltage Cutoff.....	4	Pre-Flight Checks	24
Main Landing Gear Installation.....	5, 6, 7	Flying your RV-8	25
Tailwheel Installation.....	8	Airframe Repairs.....	26
Vertical Fin Installation.....	9	Replacing Servos.....	26
Aura 8 AFCS.....	10	Aircraft Troubleshooting Guide	27
Transmitter Setup	11	Limited Warranty.....	28
Connecting a Battery/Arming the ESC	12	AMA Safety Code	29
LED Controller Connections (Night Version Only).....	12		
Receiver Installation/Servo Connections.....	13, 14, 15		

INTRODUCTION

Unparalleled Flight Performance

The Flex Innovations RV-8 is a massive, yet lightweight airframe that offers an incredibly wide flight envelope. From beginners to experts, the RV-8 has something to offer everyone. Beautiful scale lines, clear canopy with pilot figure and a beautiful color scheme deliver a true-to-scale presence in the air and on the ground.

With over hundreds of designs, World F3A and Free Style Champion Quique Somenzini has maximized the simplicity and practicality of the RV-8 design and matched it with the incredible Aura 8 Flight Control System (AFCS) for the ultimate stability with out interfering with the pilot's control. It takes less than one-hour to assemble out of the box and remains quick to assemble at the field, yet transportable in size.

For the latest updates, features, addendums and more, before assembly, please visit:

wiki.flexinnovations.com/wiki/RV8

wiki.flexinnovations.com/wiki/Aura

- Pre-installed and custom-tuned Aura 8 Advanced Flight Control System with bounceback control
- 70-size, 500kV motor and 100A ESC for big power
- (6) New, High-Precision Potenza DS-34 servos.
- Light wing loading for easy handling
- 5-9 minute flight times depending on battery choice and throttle management
- Designed around the popular 6S 5200mAh battery.
- Light Weight EPO foam that is durable and easy to repair
- CA Hinges for free movement and large throws

BOX CONTENTS



SPECIFICATIONS

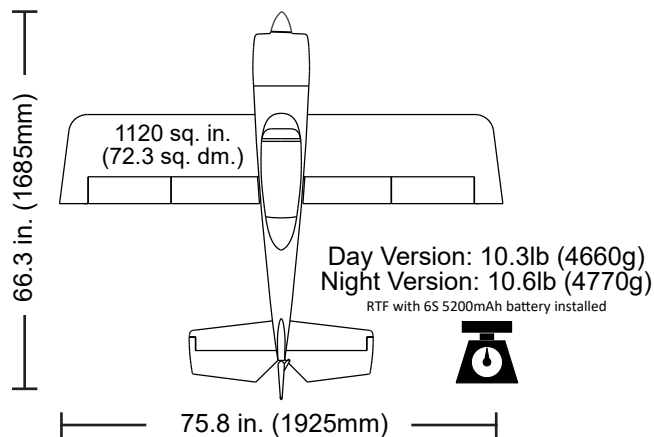

REPLACEMENT PARTS

FPM357001	Fuselage (Day)
FPM358001	Fuselage (Night)
FPM357002R	Right Wing (Day)
FPM357002L	Left Wing (Day)
FPM358002R	Right Wing (Night)
FPM358002L	Left Wing (Night)
FPM357003	Horizontal Stabilizer Set
FPM357004	Canopy Hatch
FPM357005	Aluminum Landing Gear
FPM357006	Wheel Pant, Wheel and Tail Gear Set
FPM357007	Wing and Stab Tube Joiner Set
FPM357008	Pushrod Set
FPM357009	Decal Set
FPM357010	Spinner
FPM357011	Stabilizer LED Set
FPM357012	Hardware Package
FPM357013	Pilot
FPM357014	Cowling with Screws
FPM357015	Vertical Stabilizer
FPZM1070	Potenza 70 500Kv BL Motor
FPZM10701	Potenza 70 Bolt-On Prop Adapter
FPZM10702	Potenza 70 Aluminum X-Mount
FPZM10703	Potenza 70 Motor Shaft
FPMP17570E	SR 17.5 x 7E Propeller
FPZDS34	Potenza DS34 Digital Metal Gear Mini Servo
ZTW100AEBEC	ZTW 100A ESC with 10A External BEC
FPZA1016	Potenza Advanced R/C LED Controller (6s)
FPZA1017	Potenza 1.5 in. Plastic Servo Arm (2)
FPZAURA08ZZRV8	Potenza Aura 8 AFCS for the RV-8

OPTIONAL ACCESSORIES

FPM357016	RV-8 Float Set
FPZAU01	Potenza 3pc. Male-Male Servo Connectors
FPZB52006S40	Potenza 6S 5200mAh 45C Li-Po
FPZB62006S40	Potenza 6S 6200mAh 40C Li-Po
FPZA1010	Potenza Digital Battery Analyzer
ZTWCARD	ZTW ESC Programming Card
SPMAR8010T	Spektrum AR8010T DSMX Receiver <small>(Recommended SPM Receiver)</small>
SPM9645	Spektrum DSMX Remote Receiver
FUTR2001SB	R2001SB S.BUS S-FHSS Receiver
FUTR7003SB	R7003SB S.BUS FASSTest Receiver <small>(Recommended FUT Receiver)</small>
FPM357017	RV-8 Keychain Camera Mount

COMPLETION ITEMS

INSTALLED!		Potenza 70 500Kv Brushless Outrunner Motor (FPZM1070)
INSTALLED!		ZTW 100A ESC with 5V/10A BEC (ZTW100AEBEC)
INSTALLED!		Potenza DS34 Digital Servos (FPZDS34)
INSTALLED!		Aura 8 Advanced Flight Control System (FPZAURA08ZZRV8)
INCLUDED!		17.5 x 7 Electric SR Propeller (FPMP17570E)
NEEDED TO COMPLETE		4200-6200mAh 6S 22.2V 35C+ Li-Po (FPZB52006S40)
NEEDED TO COMPLETE		6+ Channel Computer Transmitter (7+ Channels Required for Switchable Night LEDs)
NEEDED TO COMPLETE		Spektrum DSMX Remote Receiver(s) Spektrum SRXL Receiver Futaba S.Bus Receiver Hitec S.Bus Receiver Graupner SumD Receiver JR XBus Mode B Receiver Jeti UDI 12 Receiver 6+ Channel Receiver (any brand)

BATTERY CHARGING GUIDELINES

WARNING

FOLLOW ALL INSTRUCTIONS PROVIDED BY YOUR BATTERY AND CHARGER MANUFACTURER. FAILURE TO COMPLY CAN RESULT IN FIRE.

The assembly of the RV-8 can be accomplished in less than one hour. Prior to assembling the airplane, it is advisable to charge your battery so that you are ready to begin setup upon completion of the assembly of your model.

We recommend the use of an advanced Li-Po balancing charger for your batteries to get the maximum performance and lifespan.

Our airplanes are designed around our Potenza Li-Po batteries, and we recommend the Potenza 6S 5200mAh 40C Li-Po based on our extensive testing and development. These batteries feature an EC5 connector, so no soldering is required for use in your RV-8.

All are available at www.flexinnovations.com

SPECIAL LANGUAGE DEFINITIONS

The following terms are used throughout the product literature to indicate various levels of potential harm when operating this product:

- NOTICE:** Procedures, which if not properly followed, create a possibility of physical property damage AND a little or no possibility of injury.
- CAUTION:** Procedures, which if not properly followed, create the probability of physical property damage AND a possibility of serious injury.
- WARNING:** Procedures, which if not properly followed, create the probability of property damage, collateral damage, and serious injury OR create a high probability of serious injury.

WARNING

AGES 14+

This product is not intended for use by children under 14 years without direct adult supervision.

ATTENTION

Read the ENTIRE instruction manual to become familiar with the features of the product before operating. Failure to assemble or operate the product correctly can result in damage to the product, personal property, and cause serious or fatal injury.

All instructions, warranties and other collateral documents are subject to change at the sole discretion of Flex Innovations, Inc. For up-to-date product literature, please visit our website at www.flexinnovations.com, click on your aircraft and the Aura 8 AFCS product pages.

IMPORTANT INFORMATION REGARDING WARRANTY

Please read our Warranty and Liability Limitations section before building this product. If you as the Purchaser or user are not prepared to accept the liability associated with the use of this Product, you are advised to return this product immediately in new and unused condition to the place of purchase.

SAFETY WARNINGS AND PRECAUTIONS

Protect yourself and others by following these basic safety guidelines.

1. This manual contains instructions for safety, operation and maintenance. It is essential to read and follow all the instructions and warnings in the manual, prior to assembly, setup or use, in order to operate correctly and avoid damage or serious injury.
2. This model is not a toy, rather it is a sophisticated hobby product and must be operated with caution and common sense. This product requires some basic mechanical ability. Failure to operate this product in a safe and responsible manner could result in injury or damage to the product or other property.
3. This model must be assembled according to these instructions. Do not alter or modify the model outside of these instructions provided by Flex Innovations, Inc. as doing so may render it unsafe and/or unflyable. It is your responsibility to ensure the airworthiness of the model.
4. Inspect and check operation of the model and all its components before every flight.
5. If you are not an experienced pilot or have not flown a high-performance model before, it is recommended that you seek assistance from an experienced pilot in your R/C club for your first flights. If you're not a member of a club, the Academy of Model Aeronautics (AMA) has information about clubs in your area whose membership includes experienced pilots.
6. Keep the propeller area clear from such items as loose clothing, jewelry, long hair, or tools as they can become entangled. Keep your hands and body parts away from the propeller as injury can occur.
7. Never fly in visible moisture, or submerge the airplane or any of its electronic components in water. Permanent damage to electronic components may occur, or corrosion of components may lead to intermittent failures.

LOW VOLTAGE CUTOFF

Li-Po batteries have a nominal (rated) voltage of 3.7V per cell, and fully charged, reach 4.2V per cell. Batteries are designed to be discharged below the nominal voltage, however, if they are discharged below 3.0V per cell, damage will occur and the pack will lose capacity. For best long term battery life, set a timer and land after a time that leaves approximately 15% of the battery's capacity remaining.

Low voltage cutoff is a feature that is built into the included ESC that is designed to protect the connected battery from being discharged too far and causing permanent damage to the cells. Circuitry within the ESC will automatically detect when the input voltage from the battery pack reaches below 3.15V per cell (average) and will remove power to the motor, but still deliver power to the servos so that a safe landing may be made. If the motor begins to lose power rapidly during flight, the LVC has sensed that the total voltage of the pack has dropped below 3.15V per cell average, and the airplane should be landed immediately.

Note: The ESC is set to low timing for efficiency.

MAIN LANDING GEAR INSTALLATION

Required Tools and Fasteners:



(QTY 2) (QTY 10) (QTY 4)

#1 Phillips Screwdriver
1.5mm Hex Driver
8mm Open End Wrench
12mm Open End Wrench
Adjustable Wrench (optional)

(2) M3x12 Phillips Head Self-Tapping Screw
(10) M3x8 Phillips Head Self-Tapping Screw
(4) M3x20 Phillips Head Machine Screw
Blue Thread Lock

1. Locate the wheel pants. Use a #1 Phillips screwdriver to remove the screws from the wheel pants and separate the wheel pant halves from each other.
2. Locate the landing gear. Place the inside half of the wheel pant against the outside of landing gear leg, and the wheel pant retaining plate against the inside. Note that the retaining plates are identical. Use a #1 Phillips screwdriver and a M3x12 screw to secure the wheel pant half in place. Be sure the landing gear and wheel pant are oriented in the proper direction.

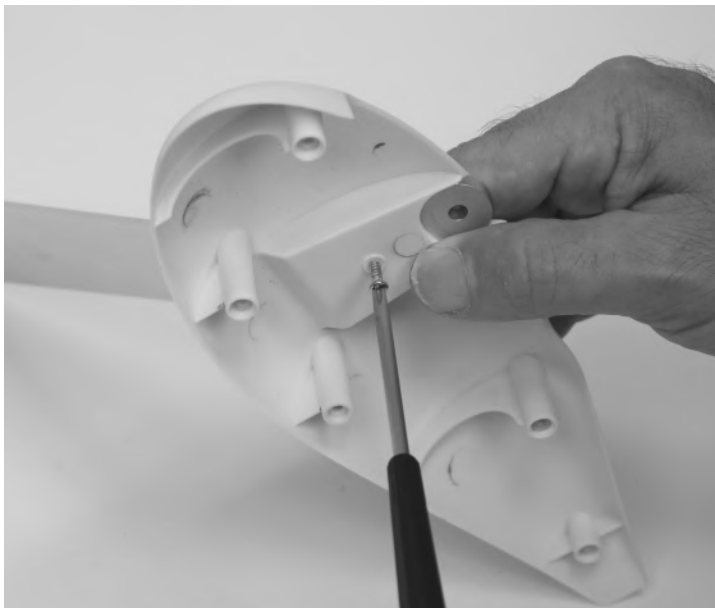
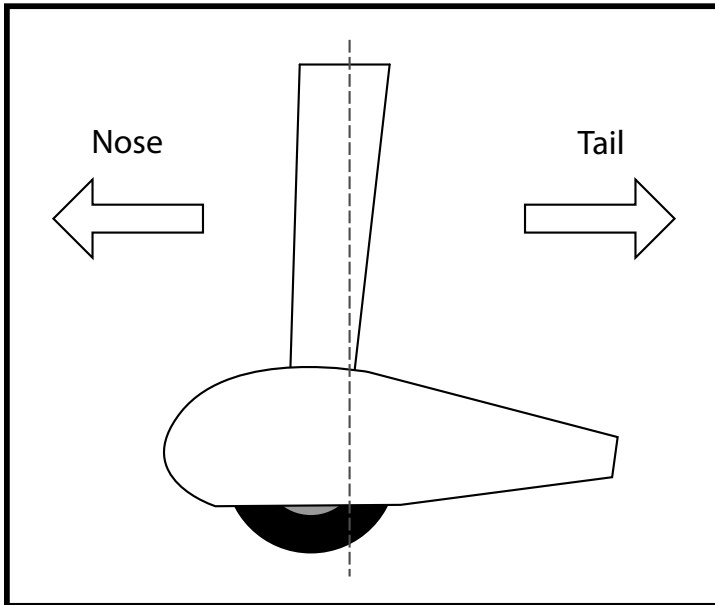

MAIN LANDING GEAR INSTALLATION (CONTINUED)

3. Locate the wheel and axle assembly. Use a 1.5mm hex driver to remove the set screws in the wheel collars. Apply blue thread lock to the set screws and re-assemble.
4. Slide the threaded end of the axle through the landing gear from the outside of the landing gear. Place a washer over the axle and apply blue thread lock to the axle threads. Secure the axle to the landing gear using an M5 nut and an 8mm and 12mm open end wrench.



MAIN LANDING GEAR INSTALLATION (CONTINUED)

6. Use a #1 Phillips screwdriver and five M3x8 self-tapping screws to secure the outside half of the wheel pant to the landing gear assembly.



7. Apply blue thread lock to the four M3x20 machine screws. Use a #1 Phillips screwdriver and the four M3x20 screws to secure the landing gear to the fuselage.

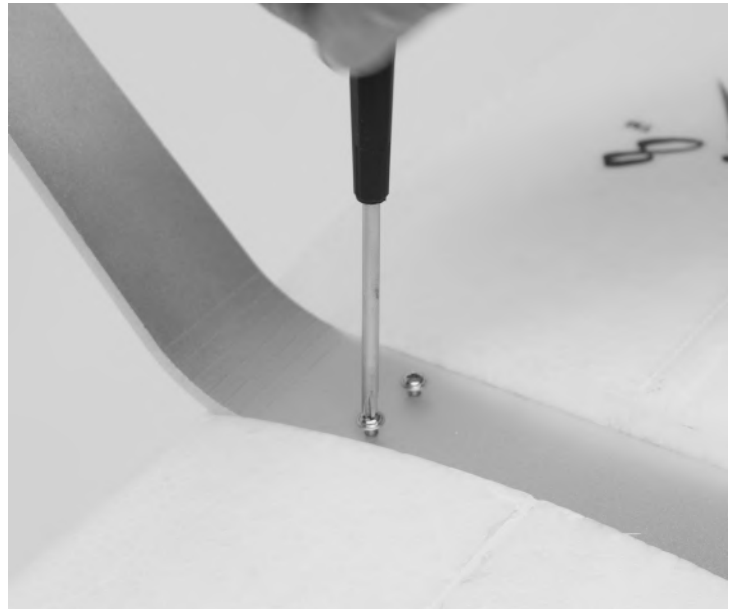
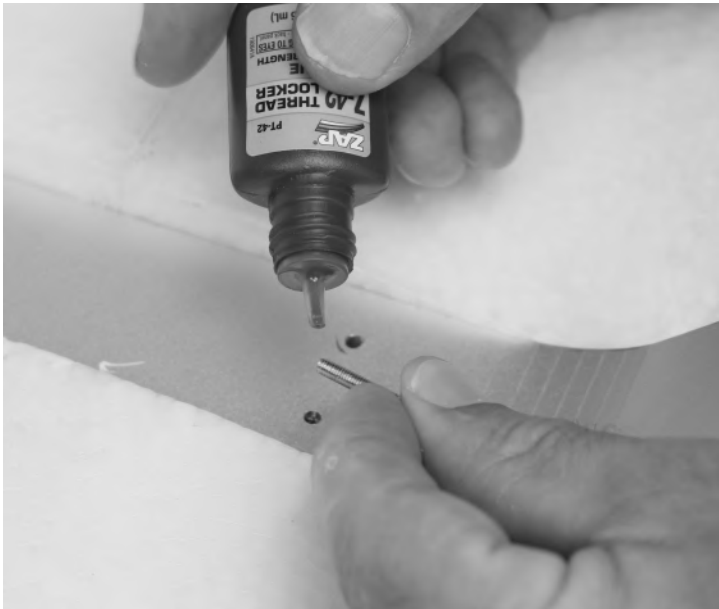

TAIL WHEEL INSTALLATION

Required Tools and Fasteners: #1 Phillips Screwdriver
(3) M3x7 Phillips Head Self-Tapping Screw



(QTY 3)

1. Locate the vertical fin assembly, tail wheel and tail wheel retaining plate. Insert the tail wheel into the bottom of the rudder, being sure to orient it so that the tail wheel wire angles towards the tail as the wire moves away from the fuselage.
2. Insert the retaining plate into the cavity on the bottom of the rudder. Use a #1 Phillips screwdriver and the three M3x7 self-tapping screws to secure it in place.

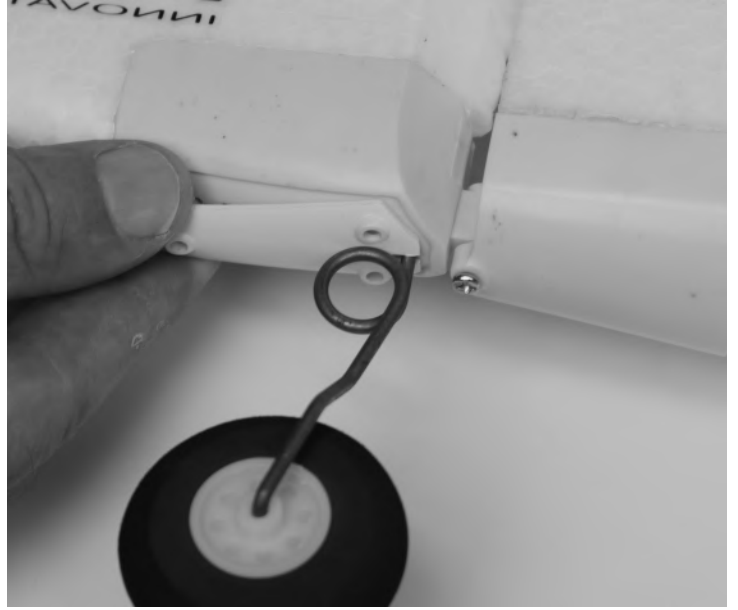

VERTICAL FIN INSTALLATION

Required Tools and Fasteners: 30-Minute Epoxy 220 Grit Sandpaper
Craft Sticks (for mixing epoxy) Paper Towels
Mixing Cup Isopropyl Alcohol

1. Locate the vertical fin assembly and vertical fin tube. The vertical fin tube is the shortest tube included with your aircraft. Test fit the vertical fin to the fuselage by inserting the tube into the vertical fin, and then into the fuselage. Confirm everything fits, and aligns appropriately. Make any adjustments and test fit again until you are happy with the fit of the parts.
2. Use 220 grit sandpaper to scuff the vertical fin tube to prepare the surface for gluing. Use a paper towel and isopropyl alcohol to clean the tube after scuffing. It is important to only scuff the tube. **DO NOT remove a significant amount of material from the tube as it can weaken the structure.**

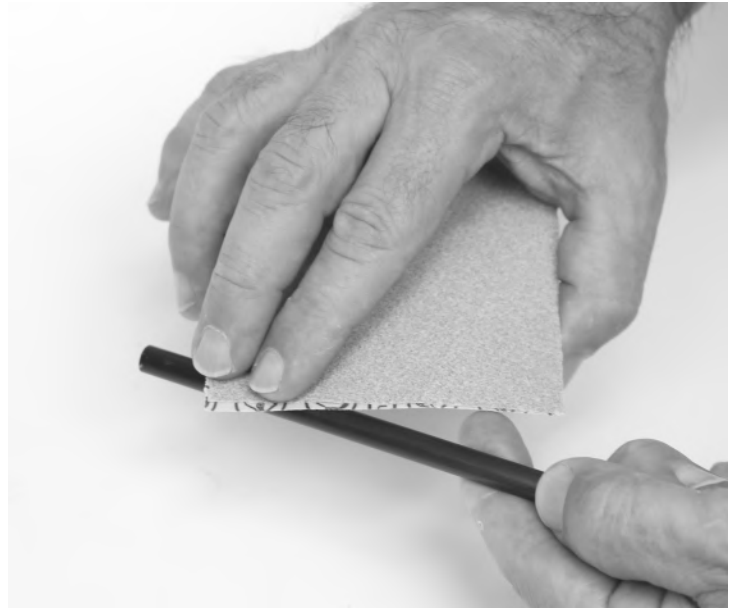
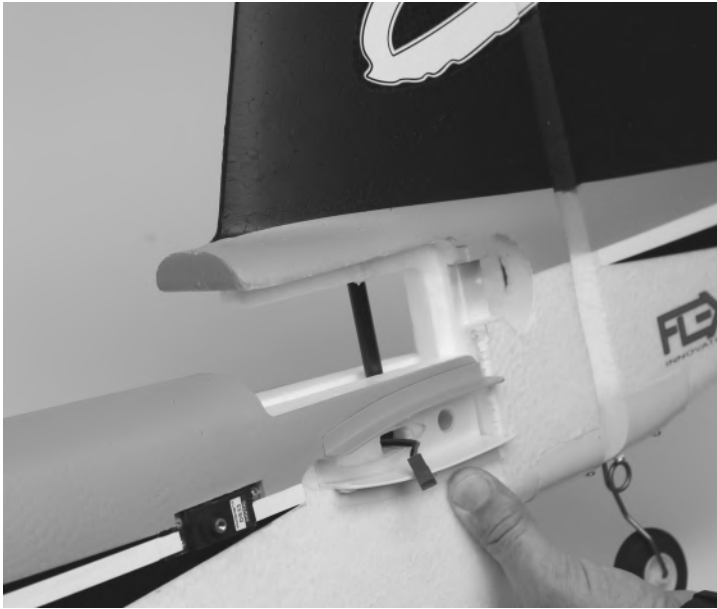

3. Use the craft sticks and mixing cups to mix an adequate amount of 30-minute epoxy. Apply epoxy to the vertical fin tube hole as well as the fuselage parts that meet the vertical fin. Assemble the parts, being sure to wipe up any excess epoxy with a paper towel. Confirm alignment, and wait for the epoxy to cure before proceeding to the next step. **DO NOT use tape to secure the fin in place as it will remove paint when it is removed.**

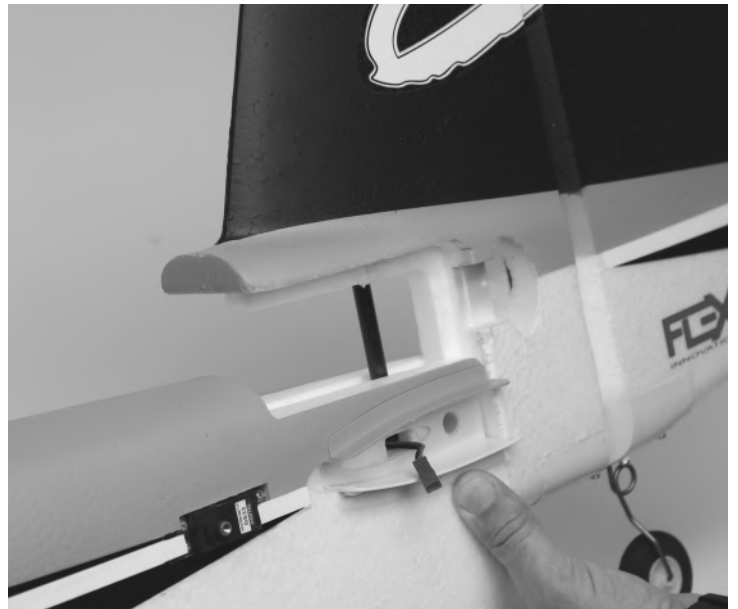

AURA 8 AFCS

The Aura 8 Advanced Flight Control System (AFCS) installed in your RV-8 is a giant leap forward in aircraft flight control system technology. Compatible with virtually every receiver on the market today, the Aura features special configuration for DSM systems via remote receiver connection(s), and serial data connection for Futaba or Hitec S.Bus, Spektrum SRXL, Graupner HOTT (Sum D of 8), JR XBus (Mode B), and Jeti UDI12 (standard) systems, as well as being compatible with traditional receivers via PWM servo connections.

The Aura 8 advanced flight control system installed in your aircraft has been pre-tuned for ease of use, eliminating many hours of tedious setup. For the latest Aura features, programs, transmitter downloads, and instructions, please visit wiki.flexinnovations.com/wiki/Aura

The Aura is programmable through any Windows based PC or tablet. All dual rate, expo, travel and assignable mode programs are adjusted inside the Aura through the PC application. An assignable master gain that is OFF by default can be enabled by the Aura application. If desired, assign CH 8/AUX 3 on a proportional dial or slider.

By default, CH5/Gear is used to select the 3 flight modes by 3 position transmitter switch. CH6/Aux 1 is used to manipulate the flaps by 3 position transmitter switch. If you wish to control the LED's in your RV-8 (Night Version only), you'll need to use a standard receiver and plug the LED controller into an open channel in your receiver.

- Works conveniently with all major radio systems
- Accepts signals from DSM Remote Receiver(s), Spektrum SRXL, Futaba S.Bus, Graupner Hott (Sum D of 8), JR XBus (Mode B), Jeti UDI12 (standard), Hitec S.Bus, PPM Stream, or any brand of receiver via male to male servo connectors
- Expertly tuned and ready to use
- USB port allows loading model configurations, user programming, and firmware updates (cable included)
- Flexible and extensive programming through Windows-based PC or tablet
- 3+ flight modes allow precise or aggressive settings to be selected in flight
- 3-axis gyro utilized in RV-8 programming

Visit wiki.flexinnovations.com/wiki/Aura for the latest Aura-related product information and tips for your particular radio brand.

Description of Pre-Loaded Aura Flight Modes (FM)

Mode 1 (Gyro Off):

Gyro gain is set to 0 (off). All rates are set to low for general flight (same as Sport Mode). Exponential is tuned for comfortable flight.

Mode 2 (Sport):

Gyro gains are moderate and tuned for comfortable feel/best performance for general flight. All rates are set to low for general flight. Exponential is tuned for comfortable flight.

Mode 3 (High Rate/Live Wing Mode):

Gyro gains are moderate and tuned for general flight. Flaps work with aileron in roll. All rates are set to highest. Exponential is tuned for comfortable flight.

Each of the modes has been tuned by our team to offer a solid start. Because tastes in control feel are unique, if changes in rates and expo are needed, adjustments should be made through the Aura.

Changes in gain value can only be made through the Aura.

⚠ WARNING

DO NOT ATTEMPT RADIO SETUP WITH PROPELLER INSTALLED. INADVERTENT POWER UP COULD CAUSE DEATH OR SERIOUS INJURY.

TRANSMITTER SETUP

The Aura 8 AFCS is designed to work seamlessly with all major transmitter and receiver brands. When programming your transmitter, start with a freshly reset new model memory in your transmitter. **Make ONLY the changes shown in the Transmitter Configuration Guide unless otherwise noted.**

The Aura 8 in your aircraft defaults to 3 flight modes that are switched via CH5/Gear in your transmitter. You may need to reassign CH5/Gear to a 3-position switch.

The Night LEDs are switchable on/off via the transmitter. You will need to use a standard receiver, and plug the LED controller into an open channel port in your receiver. You may need to reassign that channel in your transmitter to a 2-position switch.

Consult your transmitter manual if you have questions on how to change the switch or channel assignments.

The Aura comes pre-programmed with dual rates and expos specifically designed for your aircraft. For large (greater than 5%) changes in expo or dual rates, it is highly recommended to reset all expos and rates to default in the transmitter, and tune through the Aura Config Tool.

The Aura Config Tool is free to download, and can be used on any Windows-based PC or tablet. Download at:

www.flexinnovations.com/AuraConfigTool

TRANSMITTER CONFIGURATION GUIDE		
	Spektrum, Futaba & Graupner	JR DMSS ¹
Wing/Tail Type	1 Aileron, 1 Flap, 1 Elevator, 1 Rudder	1 Aileron, 1 Flap, 1 Elevator, 1 Rudder
End Points (Travel Adjust or ATV)	Ail/Ele/Rud 125%	Ail/Ele/Rud 88%
	Thro/Gear/Flap 100%	Thro/Gear/Flap 88%
Reversing	None Required²	None Required
Sub Trim	Verify at zero, NOT ALLOWED	Verify at zero, NOT ALLOWED
Trim Levers	Verify at zero	Verify at zero
CH. 5 (Gear)	Assigned to a 3-position switch	Assigned to a 3-position switch
CH. 6 (Flap)	Use flap system, assign CH. 6 (Flap) to a 3-position switch Set switch position values to 0% (neutral), -50% (takeoff), -100% (full flap)	
Flap > Ele Mix	Neutral - 0% Takeoff - 17% Down Elevator Landing - 17% Down Elevator	
Timer ⁴	Set to 5:30 for initial flights	

1. JR transmitter users that use Spektrum DSM2/DSMX receivers should follow the Spektrum information in the chart above.
2. If you are using a Futaba transmitter, please note that some Futaba transmitters have the throttle set to reversed by default. Leave reversing set to defaults to start, and reverse as needed.
3. This is only required to switch the LEDs on/off via the transmitter. If the LED controller is unplugged from the receiver or Aura 8, the lights default in the ON position when powered.
4. This aircraft can fly anywhere between 5 and 9 minutes (w/6S 5200mAh Li-Po), depending on flying style.

NOTICE

FOR CUSTOMERS USING TRANSMITTERS OTHER THAN WHAT IS LISTED IN THE CHART ABOVE, PLEASE VISIT OUR WIKI PAGE FOR INSTRUCTIONS SPECIFIC TO YOUR TRANSMITTER AND RECEIVER BRAND

JETI wiki.flexinnovations.com/wiki/Aura/JetiUse

HITEC wiki.flexinnovations.com/wiki/Aura/HitecSbusUse

FRSKY wiki.flexinnovations.com/wiki/Aura/FrSkyUse

CONNECTING A BATTERY/ARMING THE ESC

Observe the following procedures to safely power up your model after it has been bound. **Ensure propeller is removed unless sequence is followed to power up before flight.**

1. Lower the throttle stick and trim to their lowest setting and turn on the transmitter. Wait for your transmitter to indicate the radio signal is being broadcast before proceeding.

If a battery is connected to the ESC with the throttle fully open on the active transmitter, the ESC will enter programming mode. If this occurs, simply disconnect the battery, lower the throttle, and reconnect the battery.

2. Ensure the aileron, elevator and rudder gimbals are centered.
3. With the airplane on a solid surface, connect the battery to the ESC and wait. The ESC will make the motor emit a series of audible tones during its initialization process.
4. The ESC will make the motor emit a short, final tone sequence indicating that the ESC is now armed, and that the motor will spin in response to throttle stick movement.

! WARNING

When making adjustments to linkages, transmitter settings or the Aura 8 flight control system, remove the propeller to guard against accidental spool up.

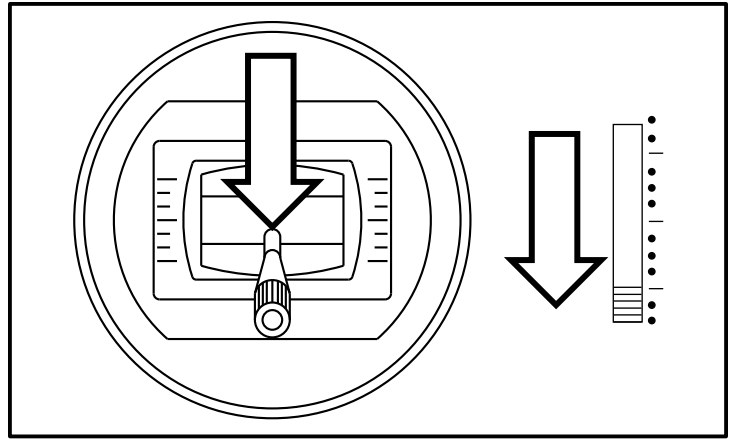

! CAUTION

Always connect the battery when the throttle stick and throttle trim is in the idle/cut-off position.

! WARNING

Hold the aircraft securely when connecting the battery before flight. Always ensure the propeller is clear of any and all objects as they may become entangled.

CONNECTING A BATTERY TO THE LED CONTROLLER (NIGHT VERSION ONLY)

The LEDs on your aircraft are switchable via the transmitter, and are designed to be powered by 12 volts (3S Li-Po) through the 6S JST-XH balance tab on the LED controller. By default, the LED controller is left unplugged.

IN ORDER TO CONTROL THE LEDS FROM THE TRANSMITTER, YOU MUST USE A STANDARD RECEIVER THAT IS CAPABLE OF 7+ CHANNELS, AND KEEPS THE SERVO PORTS ACTIVE WHEN USING A DIGITAL DATA STREAM (like S.Bus, SRXL etc.).

If the servo lead of the LED controller is not plugged into the Aura or a receiver, the LEDs will default in the ON position, allowing the Night Version to be flown at night with a basic 6-channel transmitter or receiver.

The LEDs should be powered from a separate 3S Li-Po battery per the diagram below.

! WARNING

The LEDs draw approximately 2.5A from ONLY 3 cells of the battery powering it. If using a higher cell count battery for power, 3 of the cells will have a lower voltage than the others at the end of each flight. Leave excess voltage in the battery at the end of each flight to prevent the over-discharging of the cells that power the LEDs. **You MUST balance charge** your batteries after each flight the LED controller is powered by anything other than a 3 cell battery.

! WARNING

Do not leave the battery plugged into the LED controller for extended periods of time. Doing so can damage the battery.

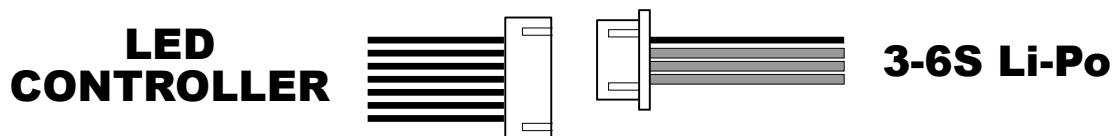

RECEIVER INSTALLATION/SERVO CONNECTIONS

Aura will auto-detect modern digital receiver connection(s). Using a modern digital receiver connection gives the Aura access to precise data of each channel for additional gyro-enabled outputs, simplifies wiring, and allows for more advanced features. To connect a modern digital receiver connection, follow the steps on this page, then skip ahead to page 16.

For traditional PWM receivers without digital connection(s), male to male servo leads must be used for each channel. Please refer to the connection diagram on page 15.

DEFAULT AURA CONNECTIONS

S1	Throttle (ESC/BEC)
S2	Left Aileron
S3	Right Aileron
S4	Elevator
S5	Rudder
S6	Left Flap
S7	Right Flap
S8	Float Water Rudder

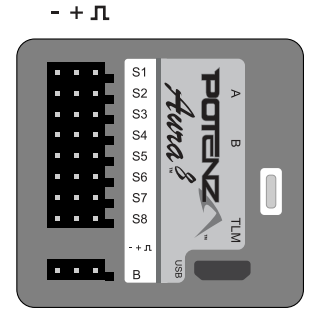

Supported Modern Data-Linked Receivers

Aura will auto-detect these modern digital receiver connections:

Spektrum Remote Receiver(s) Futaba or Hitec S.Bus Graupner HOTT (Sum D of 8)	Spektrum SRXL JR XBus (Mode B) Jeti UDI12 (standard)*
--	---

A PPM (8CH, negative shift, approximately 22ms/frame) receiver may also be connected into Port 'B', however Aura will not auto-detect and setup must be performed through the Aura Config Tool (Windows Application).

For specific information on receiver types and our recommended receivers for this aircraft, please visit the RV-8 Wiki page at the below URL:

wiki.flexinnovations.com/wiki/RV8

Connecting Your Receiver to Aura

Digital Receiver Connections

Examples of Recommended Receivers:

Spektrum SRXL AR7700 AR8010T AR9030T	Futaba S.Bus S-FHSS - R2001SB FASST - R6303SB FASSTest - R7008SB
JR XBus RG612BX RG712BX	Graupner SUMD GR-12L GR-16L
Jeti UDI EX R6i EX R11	Hitec S.Bus Optima SL-8
FrSky S.Bus RX6R RX8R	

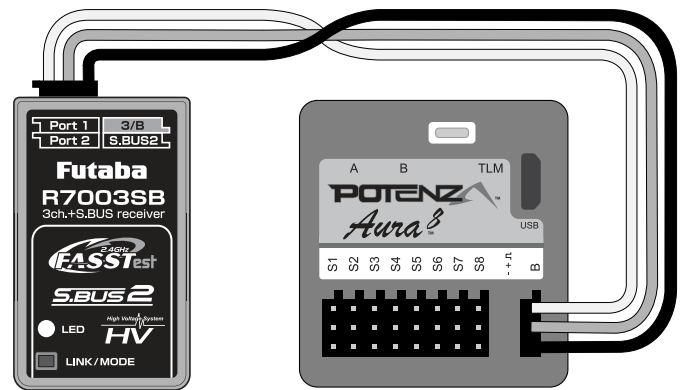

Note: If you are using Futaba S.Bus, be sure to use the proper S.Bus port in your receiver. DO NOT use the S.Bus 2 port, as it is not supported for use with the Aura 8. Refer to your manufacturer's instructions for proper S.Bus use.

1. While Spektrum and Futaba usually output their digital data stream, it may be necessary for JR DMSS, Graupner HOTT, and Jeti users to program the transmitter/receiver to output the correct digital format listed on the previous page. Consult your transmitter and receiver manuals for further details.
2. Bind your transmitter and receiver per your manufacturer's instructions.
3. Connect the included male to male servo extension to the receiver's data port (ex: S.Bus, SRXL etc.) and connect to servo port 'B' on the face of the Aura. Refer to your radio manufacturer's instructions for specific information on appropriate serial port connections and system settings.

If your receiver has a working throttle port while using it's digital connection, USE IT. Move the ESC (throttle) lead from Aura Port S1 to your receiver's throttle port. Consult your receiver and/or transmitter instruction manual for specific details on your system.

4. With the transmitter powered, power up the aircraft. Aura will search (sweeping LEDs) and lock onto the signal. You will then see solid orange (power and calibrated sensor) plus solid green (valid radio source), and have control of the model.

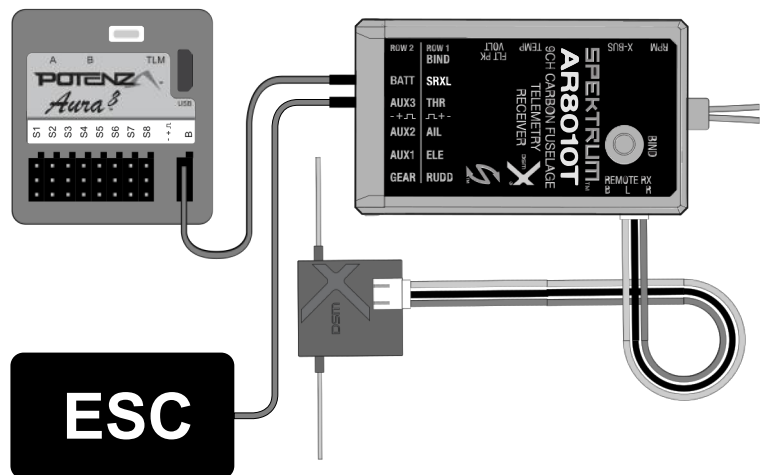

Note: When using Spektrum SRXL to connect to the Aura, always connect the remote receivers to the Spektrum receiver, NOT to the Aura.

RECEIVER INSTALLATION/SERVO CONNECTIONS (CONTINUED)

Spektrum Remote Receivers

Please note, for optimum connection reliability and performance using Spektrum, the Flex Team **HIGHLY** recommends the use of a traditional receiver with SRXL (like the AR8010T or AR9030T). Remote receivers may still be used, however.

1. Connect (2) **matching** Spektrum remote receivers to Mini Port 'A' and Mini Port 'B' at the top of the Aura case.
- 2A. To bind a **DSMX** Spektrum remote receiver connection, insert a bind plug into Aura Port **S8**.
- 2B. To bind a **DSM2** Spektrum remote receiver connection, insert a bind plug into Aura Port **S1 AND S8**.

If you are unsure which type of DSM remote receiver you have, start by attempting the bind process with a bind plug in S8. If you continue to have trouble binding, then insert one bind plug in S1, and one bind plug in S8.

3. Connect the flight battery to the ESC and the remote receivers will begin to flash, indicating that they are ready to bind. Follow the instructions provided with your transmitter to complete the bind process.
4. Once bound (indicated by both remote receivers showing a solid orange LED), Aura will begin the Auto-Detect process, indicated by sweeping LEDs on the Aura. Once complete, you will see a solid orange (power and calibrated sensor) and solid green (Aura receiving valid receiver data) LED, indicating that the Aura is in its flight ready state.
5. Mount your receivers using double sided foam tape or hook and loop tape. Consult your receiver manual for proper mounting orientations and procedures.

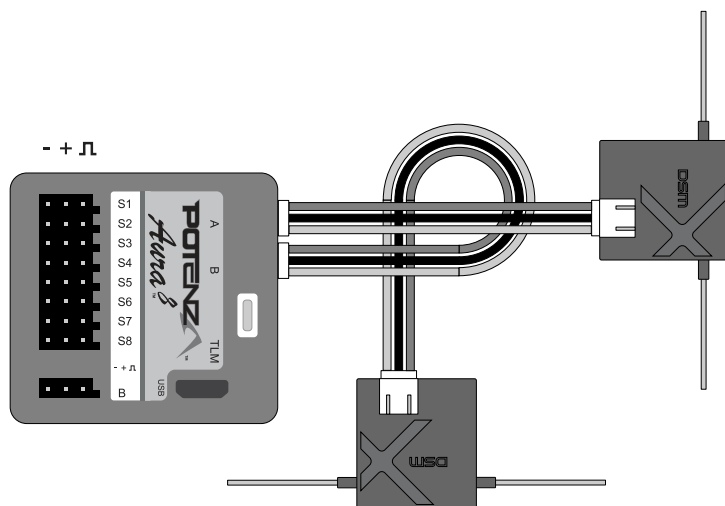

Note: It may be necessary to move the ESC lead to another open port (such as 'Port B') during the binding procedure. Be sure to return the ESC lead back to S1 after binding is complete.

Note: There are many JR-branded remote receivers that use Spektrum DSM2 and DSMX RF protocol. For these, follow the instructions as Spektrum remote receivers.

RECEIVER INSTALLATION/SERVO CONNECTIONS (CONTINUED)

Connecting a Traditional Receiver to Aura with PWM Servo Connections

PWM is an acronym which stands for Pulse Width Modulation. A servo will move to a specific angle in a specific direction based on the width of the signal pulse it receives. Most transmitters output a total pulse width of 1.1-1.9ms, with the midpoint being 1.5ms. Lower pulse widths will move the servo to one side of neutral and higher pulse widths to the other side of neutral. Different from serial data connections (S.Bus, SRXL etc.) this is how traditional receivers work. In order to utilize this type of receiver connection with your aircraft, male to male servo leads to connect the corresponding receiver ports to Aura are required. A minimum 6-channel receiver is required to set up Aura with PWM servo connections. **Please purchase FPZAU01 Aura 3-piece male to male servo cable/S.Bus to complete the PWM connection setup.**

1. Bind your receiver to your transmitter by following the instructions provided by your transmitter and receiver manufacturer. Verify that it is bound by connecting a spare servo to the receiver and verify that it responds to the appropriate input.
2. With the transmitter and receiver powerd OFF, connect your receiver to Aura using the diagram below. Note that the throttle is plugged directly into the receiver, and other connections will need to removed per the diagram below. Depending on your particular transmitter, you may need to reverse the throttle in the transmitter when the ESCs throttle lead is plugged directly into your receiver.

NOTICE

VERIFY PROPER POLARITY OF ALL CABLE CONNECTIONS PRIOR TO ADDING POWER TO THE SYSTEM

All four (4) PWM male to male connections must be connected AND connected in the proper polarity from receiver outputs to Aura inputs for Aura to activate servo outputs. (Aileron - S1, Elevator - S2, Rudder - S3, Gear/CH5 - S4)

3. With the propeller removed and ALL connections made (observing correct polarity), power on your transmitter and the airplane with the flight battery, ensuring that the airplane is kept stationary. After a few seconds, the LEDs on Aura will sweep back and forth as Aura searches for a valid control signal. Once found, a solid orange (aura Running), and solid green (Aura receiving valid signal from the receiver) LED is illuminated. After the source is found, apply transmitter right rudder to assist Aura to determine your radio type, after which point control of the model is established. This is only required during initial setup

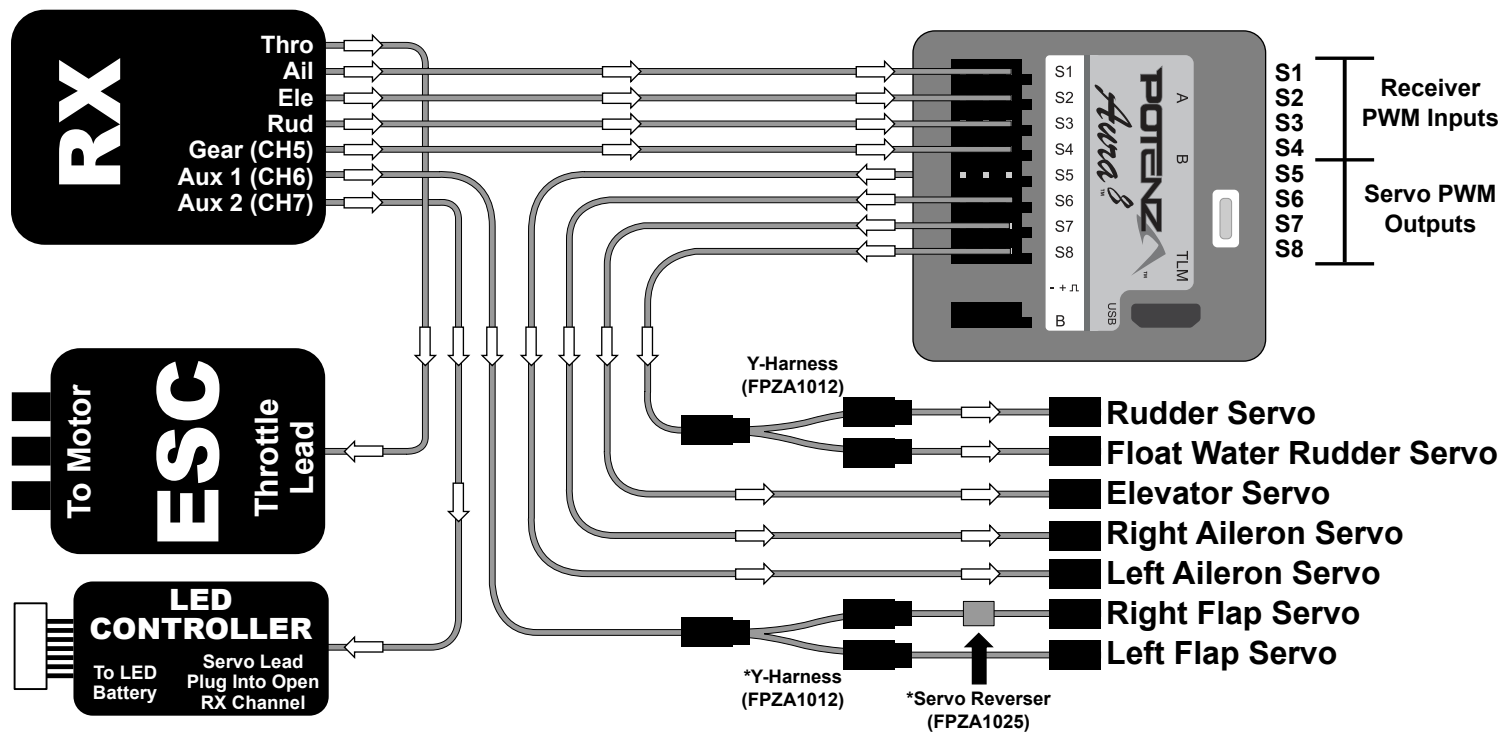

Note: The LEDs on the RV-8 Night Version are able to be turned on and off via a channel from your transmitter. Simply plug the servo lead from the LED controller following the diagram above and assign that channel to a 2-position switch on your transmitter accordingly.

If you do not have an available channel on your transmitter and/or receiver for the LED controller, you can simply leave the servo lead unplugged, and the lights will be on by default (once powered). Be sure to secure the wiring to the fuselage.

If you are using a traditional Spektrum receiver, with remote receivers, DO NOT plug any remote receivers into the Aura 8. They should instead be plugged directly into your traditional receiver.

* Y-Harness and Servo Reverser is not required if using a 7+ channel transmitter and receiver (or 8+ if you want switchable LEDs) with dual flap servo and independent servo reversing capability.
 ** Arrows indicate signal (data) flow. They do not necessarily indicate voltage (+) flow.

HORIZONTAL STABILIZER INSTALLATION

Required Tools and Fasteners:

#1 Phillips Screwdriver
Blue Thread Lock

(4) M3x8 Phillips Head Self-Tapping Screw



(QTY 4)

1. Insert the horizontal stabilizer tube into the fuselage and roughly center.
2. Slide the left and right sides of the horizontal stabilizer onto the tube. Ensure the control horn orients to the bottom of the fuselage and that the elevator joiner tabs are indexed properly. Do not force the stabilizer into place.
3. Use a #1 Phillips screwdriver and two M3x8 Phillips head self-tapping screw to secure each stabilizer in place.



RUDDER AND ELEVATOR LINKAGE INSTALLATION

Required Tools and Fasteners:

Elevator and Rudder Pushrod Assemblies
M2x10 Phillips Head Machine Screw (4)
M2 Flat Washer (4)
M2 Lock Nut (4)
M3x6 Phillips Head Machine Screw (4)

#1 Phillips Screwdriver
#0 Phillips Screwdriver
Needle-Nosed Pliers (or Hemostats)
Blue Thread Lock

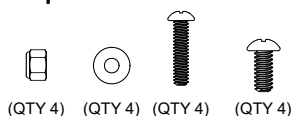

1. Locate the rudder and elevator pushrod assemblies, as well as the servo arms and hardware. Note that both pushrods and servo arms are the same length.
2. Power on your transmitter, and move your Flight Mode switch (assigned on page 11 of this manual) to Mode 1 (Gyro Off). Power on the airplane, and confirm the Aura is in Mode 1 by rotating the airplane quickly, and verifying that you get no gyro controlled servo movement.
3. With the aircraft still powered on, install the rudder and elevator servo arms perpendicular to the servo case, being sure to orient the servo arm towards the bottom of the fuselage. **Apply blue thread lock** to the M3x6 phillips head machine screw, and secure the servo arm in place with a #1 Phillips screwdriver.

WARNING

DUE TO VARIANCES IN PRODUCTION AND THE LARGE CONTROL SURFACE THROWS ON THIS AIRCRAFT, PROPER SERVO CENTERING AND TRAVEL ADJUSTMENT IS CRITICAL TO PREVENT SERVO OVER TRAVEL AND FAILURE. IF THE SERVO ARMS ON YOUR AIRCRAFT DO NOT SIT PERPENDICULAR TO THE SERVO CASE, YOU MUST USE THE AURA CONFIG TOOL TO ADJUST THE SUB-TRIM AND OUTPUT SCALE VALUES TO PREVENT OVER TRAVEL OF THE SERVOS.

To download the Aura Config Tool, please visit:
<https://www.flexinnovations.com/articles.asp?ID=257>

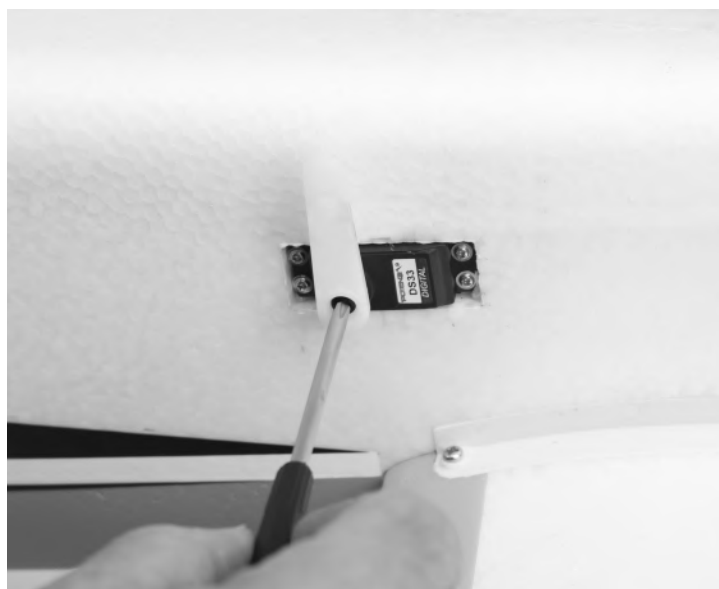

RUDDER AND ELEVATOR LINKAGE INSTALLATION (CONTINUED)

- Use a #0 Phillips screwdriver, M2x10 machine screw, M2 washer and M2 lock nut to secure the linkage to the control horn and servo arm. Use the chart below for proper control horn and servo arm linkage locations. The order of components is as follows:

M2x10 Machine Screw
M2 Washer
Servo Arm or Control Horn
M2 Lock Nut

- Repeat the process for the other control linkage.

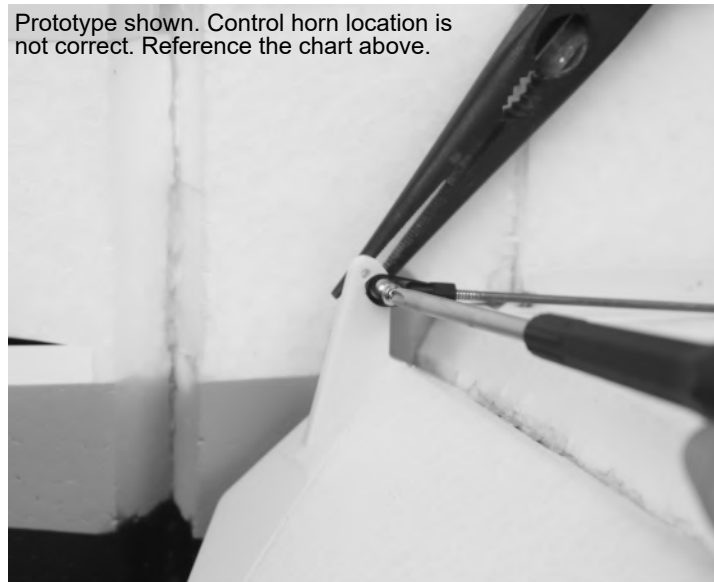
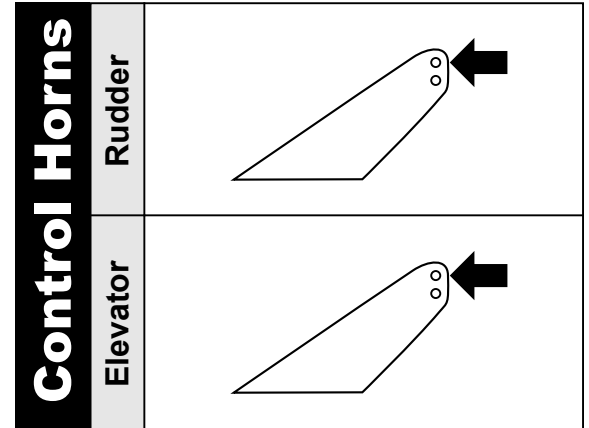
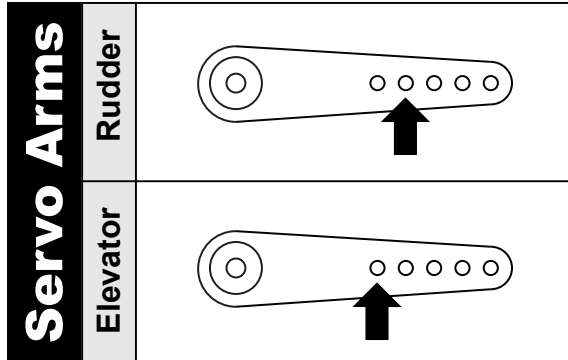

MAIN WING INSTALLATION

Required Tools and Fasteners:

M4x18 Thumb Machine Screw (2)



WARNING

REMOVE THE AILERON SERVO SCREWS AND APPLY BLUE THREAD LOCK TO THE SCREWS. RE-INSTALL THE SCREWS AND TIGHTEN FULLY. FAILURE TO DO SO MAY RESULT IN A CRASH

1. Remove the canopy from the fuselage by pulling the latch to the rear and lifting the canopy from the fuselage. Insert the main wing tube into the fuselage and roughly center.
2. Slide the left and right wing panels onto the tube. Ensure the servos orient to the bottom of the fuselage.
3. Connect the aileron servo leads to their respective extensions in the fuselage. If you have a night version, connect the wing JST to the LED controller JST connector per the diagram below.
4. Fully seat the wing into the fuselage while being careful to align the wing mounting tab with the slot in the fuselage. Be sure to avoid pinching any wires during this process. Secure the wing to the fuselage using a M4x18 thumb screw.

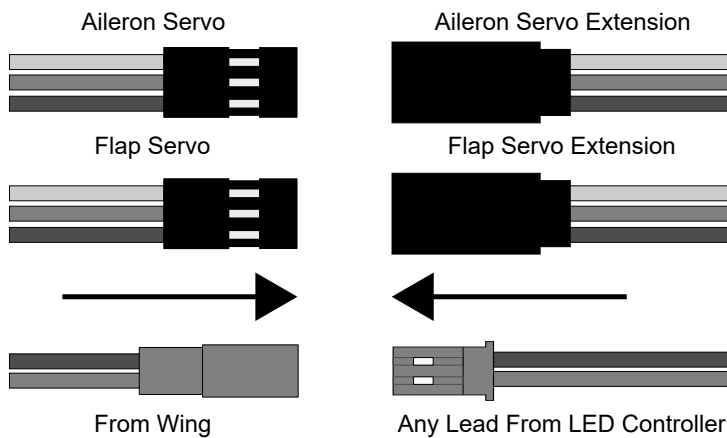
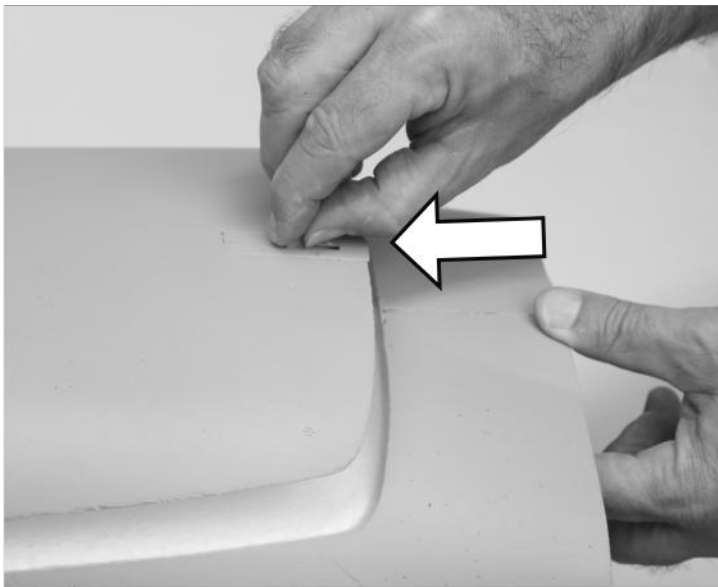

*JST connector for Night Version Only



TRANSMITTER CONTROL DIRECTION TEST

Refer to the chart below to determine the proper control surface directions.

If controls are reversed, DO NOT REVERSE CONTROLS IN THE TRANSMITTER OR THE AURA CONFIG TOOL. Email us at support@flexinnovations.com for corrective action. Note that BOTH the Transmitter Control Direction Test AND the Flight Controller Sensor Direction Test MUST BOTH BE PASSED! IF ONE DOES NOT PASS, DO NOT FLY!

Note: There is a pre-configured rudder to elevator mix programmed into the Aura. If you see the elevator move with rudder stick input, this function is intentional and completely **NORMAL**.

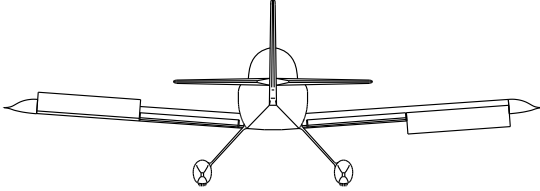
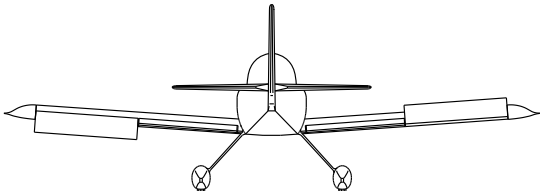
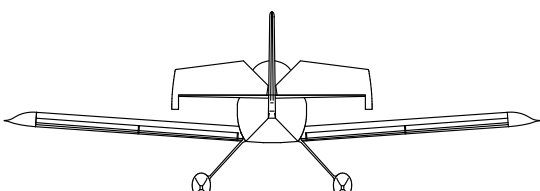
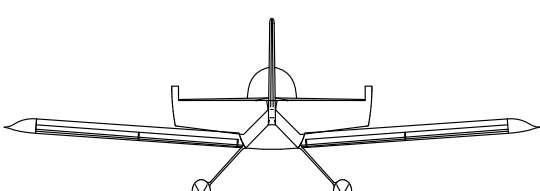
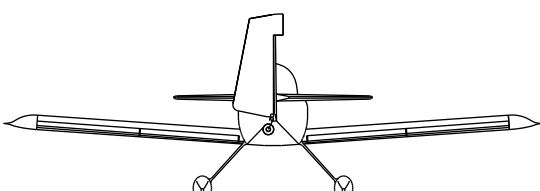
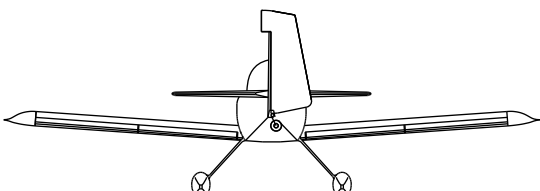
		Stick Movement	Proper Control Surface Deflection
AILERON	Stick Left		
	Stick Right		
ELEVATOR	Stick Aft		
	Stick Forward		
RUDDER	Stick Left		
	Stick Right		

FLIGHT CONTROL SENSING DIRECTION TEST

Perform a test of the gyro system to verify the corrections made for a given movement are correct. If any of the tests do not result in the correct reaction for the airplane's gyro system, **DO NOT FLY THE AIRPLANE**, and contact us via email at support@flexinnovations.com.

The flight control system activates with RF broadcast. Perform these tests in Mode 3 (higher gain) for better visibility, and then again in Mode 2, and any other flight modes that have gyro gains assigned. (By default, Mode 1 has no gain assigned.) Control surface deflections are exaggerated in the drawings below for clarity. Please note that the control surfaces will move **ONLY** while the aircraft is **ROTATING**.

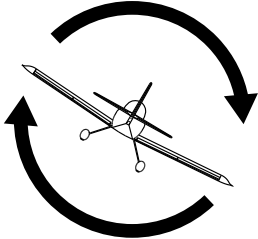
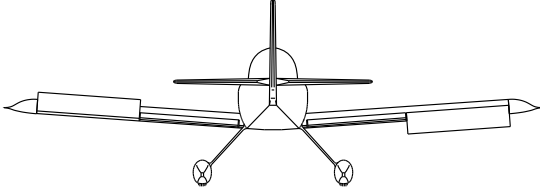
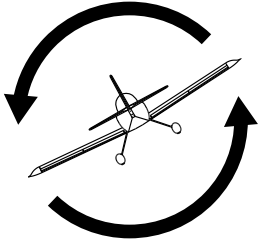
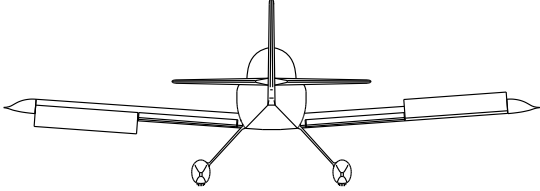
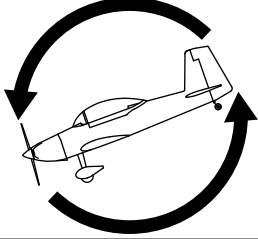
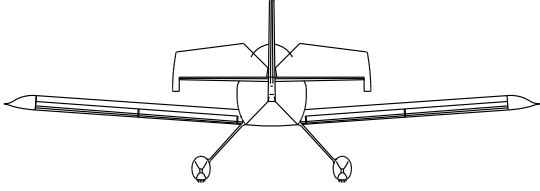
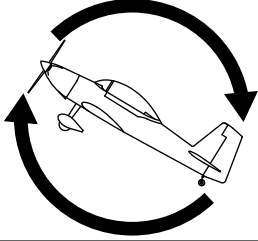
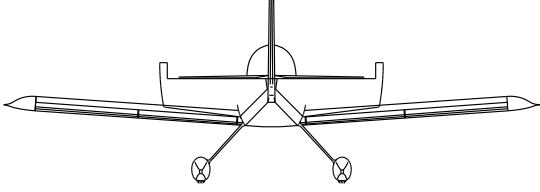
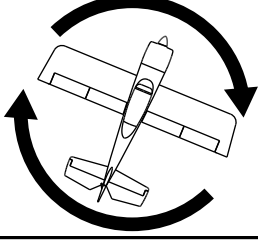
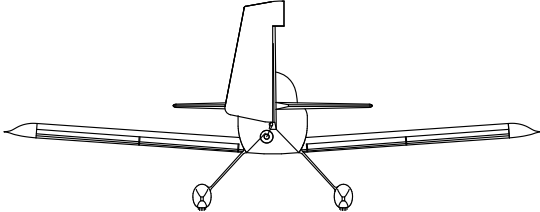
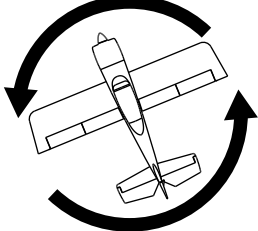
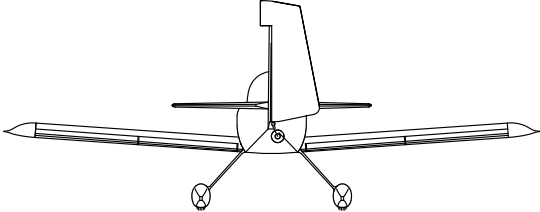
	Aircraft Movement	Proper Control Surface Deflection
AILERON		
		
ELEVATOR		
		
RUDDER		
		

EXHAUST INSTALLATION

Required Tools and Fasteners: Medium CA

CA Accelerator

1. Locate the two black foam scale exhaust pieces. Use medium CA to secure the exhaust as shown in the photo below. You can also use CA accelerator to help speed up the process.

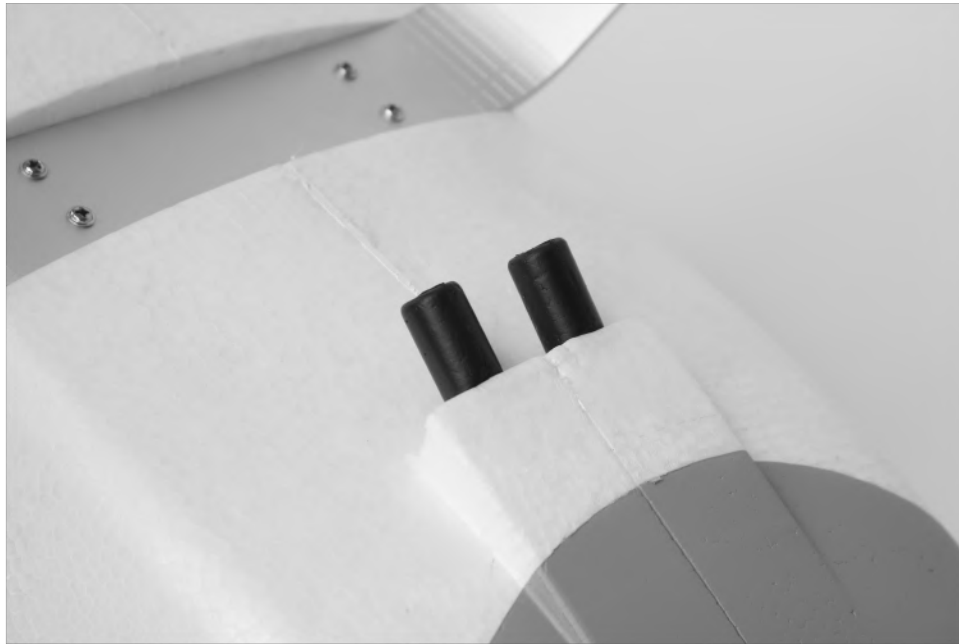

MOTOR AND PROPELLER INSTALLATION

Required Tools and Fasteners:

Motor Assembly
M4x22 Phillips Button Head Screw (4)
M4x8 Phillips Flat Head Screw (4)
M3x10 Phillips Button Head Screw (1)

M3x8 Phillips Button Head Screw (2)
M8 Nut
#1 Phillips Screwdriver
Blue Thread Lock

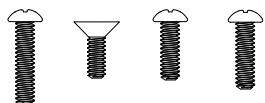

(QTY 4) (QTY 4) (QTY 2) (QTY 1)

1. Locate the motor assembly. Use a 2.5mm hex driver to remove the four prop adapter screws in the front of the motor. Apply blue thread lock to the screws and reassemble.
2. Locate the aluminum x-mount for the motor. Apply blue thread lock to the M4x12 Phillips flat head screws and use a #1 Phillips screwdriver to secure the x-mount to the back of the motor. Be sure to orient the mount so that the flat head screws sink into the mount and sit flush with the back of the motor mount.
3. Plug the motor wires into the ESC wires. There is no proper polarity; plug any one of the motor wires into any one of the ESC wires. If the motor spins backwards when you test motor function, simply swap any two wires to make the motor spin in the proper direction.
4. Apply blue thread lock to the M4x22 Phillips button head screws and use a #1 Phillips screwdriver to secure the motor to the firewall of the aircraft.



Note: Different Motor Shown



Note: Different Motor Shown

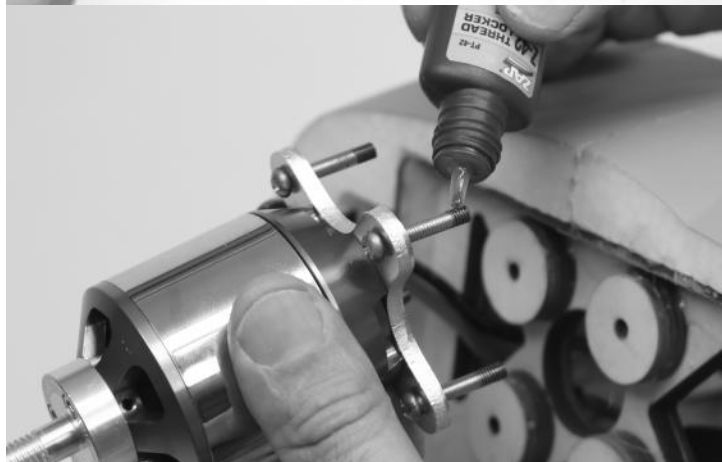

MOTOR AND PROPELLER INSTALLATION (CONTINUED)

4. Use a #1 Phillips screwdriver and two M3x8 Phillips button head screws to secure the the cowling to the aircraft.
5. Place the propeller onto the propeller adapter, with the convex side facing forward. Place the propeller washer over the shaft, and thread the propeller nut onto the propeller adapter. Use an adjustable wrench to tighten the propeller nut.
6. Place the spinner over the prop shaft, being sure to align the cutouts in the spinner with the propeller blades. Use a M3x10 Phillips button head screw and a #1 Phillips screwdriver to secure the spinner in place.

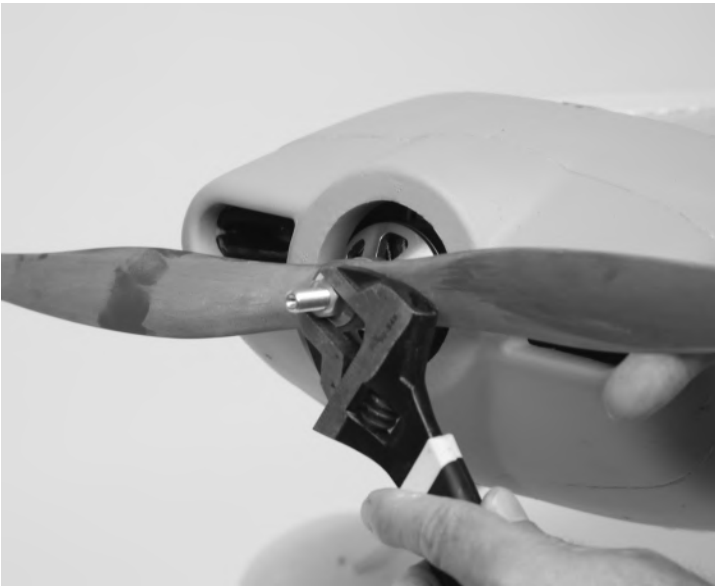
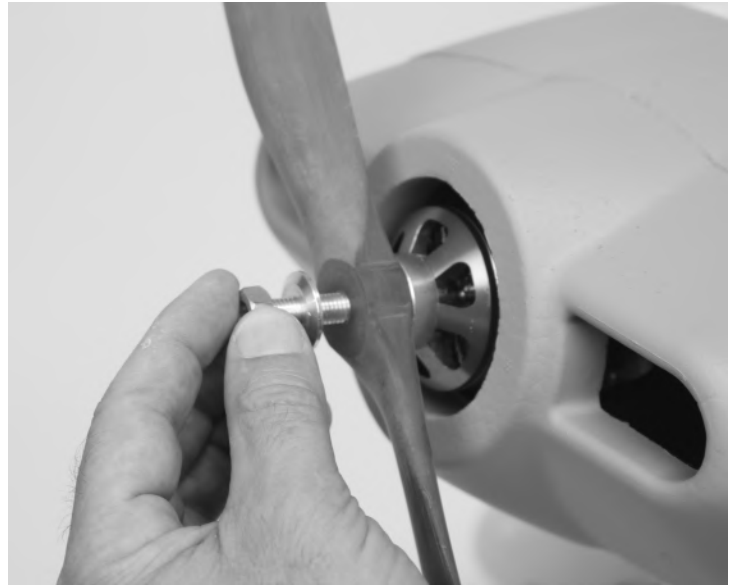
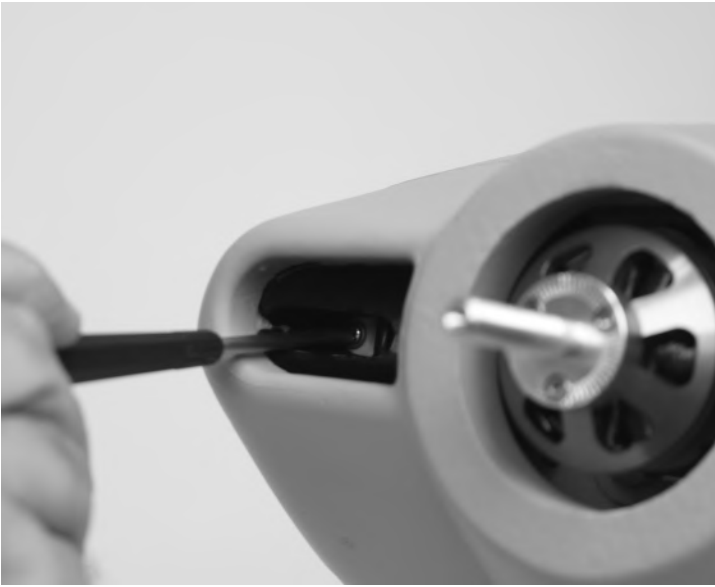

CENTER OF GRAVITY VERIFICATION

The center of gravity (CG) location for your aircraft is located in two locations depending on the flying style you wish to fly.

For general sport flying, the CG is located 11-7/32 inches (285mm) FORWARD of the trailing edge of the wing.

For more aerobatic capability, the CG is located 10-13/16 inches (275mm) FORWARD of the trailing edge of the wing.

These CGs are measured by lifting the completed airplane upright, with all components installed. This location was determined from many test flights by designer and multi-time world aerobatic champion, Quique Somenzini. Lift the airplane from the underside of the wing to check CG.

Setting the center of gravity is one of the most important steps for success, particularly with a new airplane. The RV-8 is a high-performance airplane with large control surface throws, and a high thrust-to-weight ratio. These two factors combined make it a very enjoyable aircraft to fly, but if the CG is not within an acceptable range, it will make the aircraft difficult, if not impossible to control.

NOTICE

The CG measurement should be made with the completed airframe with all components (batteries, servos, receiver, linkages, hardware, etc.) installed. Failure to do so will result in an inaccurate measurement.

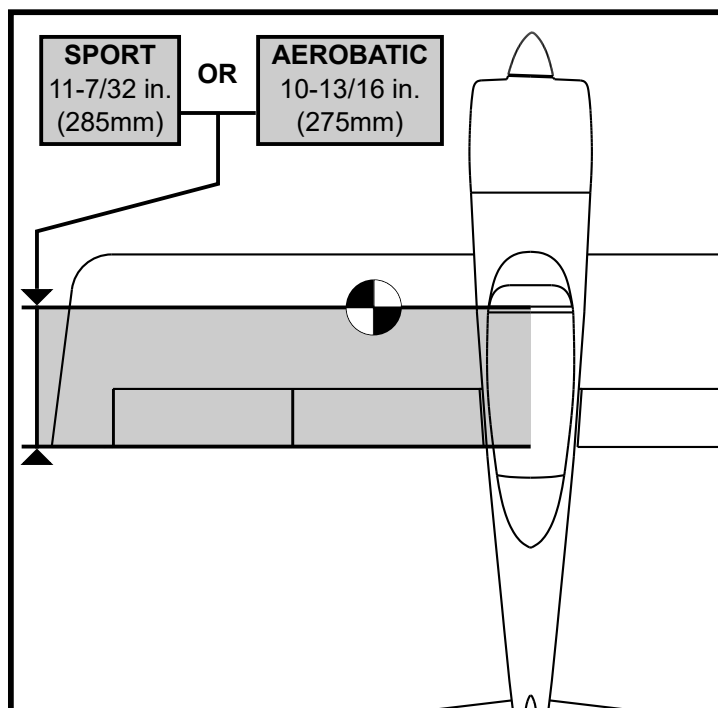

PRE-FLIGHT CHECKS

To help ensure a successful first flight, as well as many flights after, perform a few simple pre-flight checks to ensure the aircraft is ready for flight.

1. Verify control surfaces are properly hinged and in good working order. Pinch a control surface between your thumb and fore finger, and stabilize the wing with your other hand. Give the control surface a firm pull away from the wing. The control surface should not come unhinged from the wing. Be sure to avoid over-stressing the part, as an aggressive pull may cause the surface to come unhinged even though it is hinged properly. **If hinging is loose, do not fly.** Apply thin CA to the loose side(s) of the hinge(s) to resecure.
2. Verify that all hardware and all other aircraft parts are properly secured, including those connections that require blue thread lock. This includes hardware and parts installed by the factory.
3. Verify your battery is fully charged and in good condition. Avoid using batteries with swollen cells, or batteries that do not charge back to their full capacity.
4. Verify the CG is in the proper location, and the battery is secured in place.
5. Ensure the Aura is on and functioning properly. Power on your transmitter, followed by the aircraft. Ensure the Aura is calibrated properly and receiving a valid radio source (solid orange + solid green LEDs).
6. Verify transmitter stick inputs result in the proper control surface movements (reference page 20), and that all Aura flight modes work properly.
7. Verify aircraft movement results in proper Aura sensor corrections (reference page 21).
8. Verify the motor and ESC function properly. Point the aircraft in a safe direction, and away from any objects or limbs that could become entangled in the propeller. Hold the aircraft firmly so that you are behind the aircraft. Smoothly advance the throttle to full and back to idle. Listen and watch for any odd or unusual behavior from the motor and ESC.

FLYING YOUR RV-8

Selecting a Flying Site

Selecting a flying site is critical to a successful flight. Airplanes require a lot more room than other R/C products, therefore, a neighborhood or parking lot is not recommended. A local AMA field is the best location for flying your aircraft. If no AMA field is available in your area, a large open field with short grass and generous overfly area is the best candidate. Know your overfly area. Ensure that there are no houses, playgrounds, people or other buildings that may be damaged if the airplane were to crash.



Takeoff

Taxi or place the aircraft on the runway centerline, with the nose pointed into the wind. Select Flight Mode 2, then set throttle trim so that the motor spins at it's lowest RPM without stopping. For the first flight, set flaps to up. Smoothly advance the throttle to full while maintaining directional control with the rudder and slight back pressure on the elevator. The airplane should lift off smoothly before the throttle is fully open. Fly in Flight Mode 2 until the aircraft is fully trimmed (see special trimming instructions), and you are comfortable with it's handling, then explore the other modes as desired.

Flying

Altitude is your friend on the first flight. Briskly climb to a safe altitude and trim the airplane. The airplane should fly straight and level at 1/2-3/4 power with no input from the sticks. Try some basic maneuvers, and slowly progress into the airplane's flight envelope as you become more comfortable with the airplane's flight qualities and perfect your setup. **Note: if at any time, such as after gain adjustments, you experience unexpected control system inputs or oscillations, switch to Mode 1, and land and troubleshoot the issue. (Mode 1 turns the sensor inputs off with default programming)**

Landing

Be mindful of your flight time and allow adequate battery reserve for a couple of landing attempts, if necessary, on the first few flights. Select Flight Mode 2 and slow the airplane and align with the runway, into the wind. Keep the throttle at 1/8-1/4 power for the majority of the descent. The airplane should descend smoothly in this configuration with proper airspeed. Once you are close to the ground, gradually close the throttle fully and begin to smoothly apply up elevator as required to arrest descent and the airplane should gently touch down with a short roll out. **Remember, you can always smoothly advance the throttle to full, and make a go-around to set up for another landing.** You don't have to land on the first attempt. After you get comfortable landing the aircraft without flaps, you can experiment more with both flap positions on landings.

Trimming

The first several flights on your aircraft should be dedicated to trimming and setup. Fly the airplane at 2/3 power in Flight Mode 2 and trim for level flight. Land, adjust linkages and return the trim to zero, and fly again. Repeat until the airplane flies hands off, straight and level. Transmitter trim or sub-trim will cause trim shifts when different flight modes are selected. To eliminate this trim shift, you can mechanically trim the model, or you can complete Aura "Quick Trim".

Please note, due to the nature of Aura Flight Modes, trim in low rates will not be as effective as trim in high rates. This functionality is NORMAL.

Aura Quick Trim

The Aura 8 features a Quick Trim Mode that eliminates the need for mechanical linkage adjustments during test flights. Aura will learn the trim values from your transmitter, and apply them to the control surfaces at power up when enabling quick trim mode.

NOTE: Quick Trim can also be used BEFORE flying to make small changes to center the control surfaces before flight.

NOTE: ENSURE AILERON/ELEVATOR/RUDDER TRANSMITTER SUB-TRIMS ARE ZERO BEFORE FLYING FOR QUICK TRIM PROCESS

NOTE: QUICK TRIM IS **NOT** AVAILABLE TO PWM CONNECTION USERS. IF YOU ARE USING A PWM CONNECTION, YOU WILL NEED TO **MECHANICALLY TRIM THE MODEL.**

1. Fly the airplane in Flight Mode 2. Trim the aircraft with the transmitter and land. **DO NOT CHANGE FLIGHT MODES.**
2. Power off the Aura. Insert a bind plug into **Aura Port S3** (you will need to remove the servo lead that is currently in S3). Check the transmitter is on and repower the Aura.
3. Wait 5 seconds for the Aura to completely initialize. Confirm Quick Trim mode is active by checking the Blue LED is slowly flashing.
4. Remove the bind plug from **Aura Port S3**, and re-install the servo that was previously removed into S3. Removing the bind plug stores the current trims in the Aura. The Blue LED will flash quickly after control surface trim values are stored. While the trim values are stored in Aura, they are not applied to the control surface(s) until the Aura is repowered.
5. Remove power from the Aura and center all control surface trims on the transmitter.
6. Re-power the Aura. The control surfaces should be unchanged even though the trim has been centered on the Transmitter. Switch between other Flight Modes to ensure you do not see any changes in trim.

CAUTION

USE CAUTION WHEN FLYING YOUR AIRCRAFT IN FLIGHT MODE 3 AT HIGH AIRSPEEDS. DOING SO CAN INDUCE CONTROL SURFACE OSCILLATIONS AND MAY CAUSE A CRASH.

AIRFRAME REPAIRS

Your aircraft is molded from durable EPO foam and is repairable with most adhesives. Similar to building and repairing wood or composite aircraft, the correct glue for a given application is critical to the repair holding and not breaking again. For major repairs, such as a broken fuselage, epoxy is preferred because it allows time to correct any misalignment, and is less brittle than CAs. For smaller repairs, such as a cracked control surface or small chunk of material missing from the airframe, regular CA is very effective. The use of odorless (foam safe) CA is not recommended on EPO foam because it is weaker than regular CA and takes a longer period of time to cure.

NOTE: Avoid the use of CA accelerant in repairs. It can damage paint and will weaken the bond of the glue. If CA accelerant is used, be mindful of the locations of CA to prevent premature bonding of parts or bonding a hand or clamp to the airframe.

If a part is damaged too badly to be repaired, please refer to page 3 of this manual for a complete listing of available replacement parts.

NOTICE

If a crash is imminent, fully reduce the throttle to prevent further damage to the power system and reduce energy to lessen impact damage. Never allow the propeller to contact the ground under power, even at a slow idle.

CRASH DAMAGE IS NOT COVERED UNDER WARRANTY

NOTE: Avoid keeping the aircraft in direct sunlight when not flying. Excessive heat can damage the airplane's structure, and UV light can permanently discolor decals.

REPLACING SERVOS

Required Tools and Fasteners: #1 Phillips Screwdriver

1. Disconnect the servo from the Aura 8.
2. Unscrew the servo arm screw from the servo, and remove the servo arm.
3. Unscrew the two servo mounting screws at each end of the servo and remove. Please note, the aileron servo extensions are wired to the navigation lights for connection simplicity. **DO NOT** remove the aileron servo extensions from the wing, as damage to your navigation and landing lights may occur.

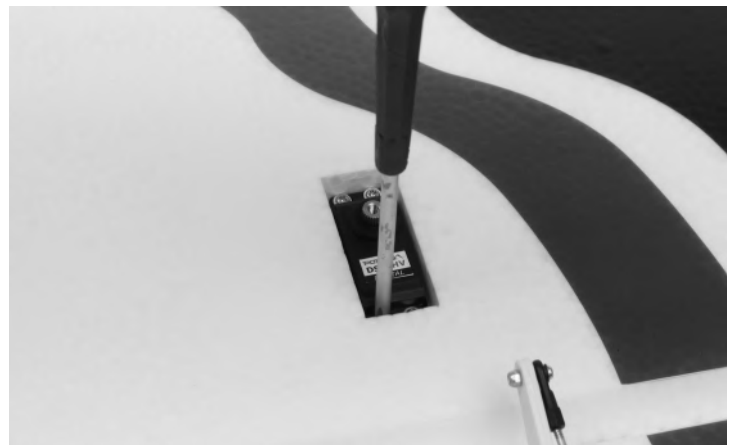
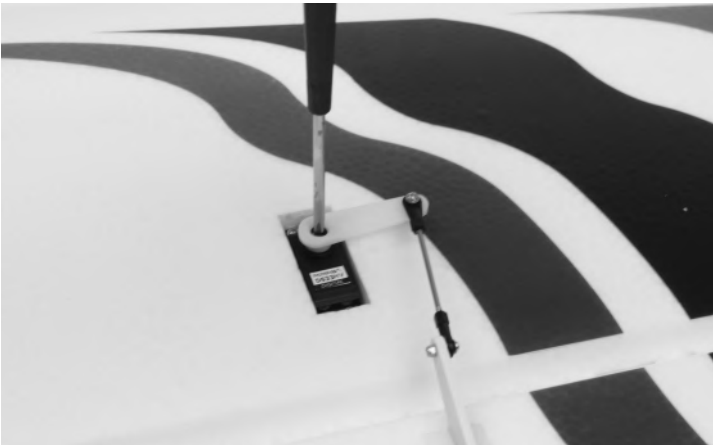

TIP: Plug a spare servo extension into the servo lead before removing to make it easier to install the lead of the servo when replaced. Note that this does not work for the aileron servo extensions, as they should not be removed per step 3 above.

AIRCRAFT TROUBLESHOOTING GUIDE

Should you encounter any abnormal situations with your aircraft, refer to the matrix below to determine probable cause and a recommended solution for the action.

If the required solution does not rectify the problem, please contact product support for further assistance.

⚠ NOTICE

Unless specifically required, ALWAYS troubleshoot the airplane with the propeller removed.

DISCREPANCY	PROBABLE CAUSE	RECOMMENDED SOLUTION
Motor nonresponsive (ESC initialization tones audible)	Throttle not at idle and/or throttle trim too high	Lower throttle stick and trim completely. If problem persists, ensure that the sub-trim and travel adjust are properly set in the radio's programming.
	Throttle channel is reversed	Reverse throttle channel in radio programming.
Motor nonresponsive (No ESC initialization tones audible)	Motor disconnected from ESC	Ensure plugs are fully seated. Check battery and/or plugs for damage and replace any damaged components found. DO NOT ATTEMPT TO REPAIR.
Motor turns in the wrong direction	The three motor wires are connected incorrectly to the ESC	Swap any TWO motor wires.
Reduced flight time or aircraft under powered	Flight battery not fully charged	Ensure battery is fully charged prior to installing in aircraft.
	Propeller installed backwards	Install the propeller so that the convex side faces forward.
	Flight battery is weak or damaged	Remove battery from service and replace with a different battery.
	Ambient temperature is too cold	Ensure battery packs are adequately warm (70°F/21°C) before flight.
	Battery capacity too small for intended use	Replace battery with one of proper capacity and discharge capacity (C rating).
	ESC reaching preset LVC (low-voltage cutoff)	Recharge battery, or reduce flight time.
	Battery's discharge rating too low	Replace battery with one of a higher discharge rating.
Excessive propeller noise and/or vibration	ESC timing set to high	Re-program ESC to low timing
	Damaged spinner, propeller, prop adapter or motor	Replace damaged components. DO NOT ATTEMPT REPAIR.
	Propeller is not balanced	Balance or replace the propeller.
	Prop nut is loose	Tighten prop nut with properly sized wrench.
	Spinner is not fully in place or tightened	Loosen the spinner bolt, adjust as required and retighten bolt.
Control surface(s) non-responsive	Propeller nut or propeller adapter threads not cut straight	Rotate 180 degrees and re-tighten or Replace propeller nut or propeller shaft. DO NOT ATTEMPT REPAIR.
	Airframe or control linkage system damaged	Replace damaged control system components. DO NOT ATTEMPT REPAIR.
	Transmitter model bound incorrectly, incorrect active model memory, incorrect Aura data input configuration, incorrect transmitter settings	Consult radio manual for proper binding and model selection instructions.
	Battery voltage too low	Use volt meter to check battery. Replace or recharge as necessary.
	Battery disconnected from ESC	Verify that battery is connected, and that the EC5 plugs are fully seated.
Failed control direction test	Battery Eliminator Circuit (BEC) damaged	Replace ESC. DO NOT ATTEMPT REPAIR.
	Damaged servo	Replace servo. DO NOT ATTEMPT REPAIR.
Control surface oscillation	Incorrect transmitter or Aura 8 setting. DO NOT FLY!	Reference transmitter and receiver sections of this manual. If no solution is found, contact customer support at support@flexinnovations.com .
	Exceeding maximum airspeed for configuration	Reduce airspeed.
	Propeller/spinner not balanced	Balance or replace spinner/propeller.
	Motor vibration	Inspect motor and motor mounting. Tighten screws as needed or replace motor.
	Loose Aura 8 Mounting	Realign and secure the Aura 8 to the aircraft.
	Excessive control linkage slop or play	Inspect control linkage system and replace components as necessary.
	Improper transmitter setup	Refer to the transmitter configuration guide in this manual to properly configure transmitter settings.
	Damaged spinner and/or propeller	Replace spinner and/or propeller as needed. DO NOT ATTEMPT REPAIR.
Trim changes between flight modes	Improperly set master gain	Ensure master gain is set for proper gain value(s).
	Trims are not properly zeroed	Use Aura "Quick Trim" feature, or mechanically trim the model and reset transmitter trim to zero.
	Sub-trims are not properly zeroed	Use Aura "Quick Trim" feature, or mechanically trim the model and reset transmitter sub-trim to zero.
PWM Receiver Connection type, and cannot get orange + green LED on Aura, and no control of model	Transmitter is out of calibration (aileron/elevator/rudder are not at neutral with sticks centered; reference transmitter monitor screen)	Calibrate transmitter (reference transmitter's instruction manual) or return transmitter to manufacturer for calibration.
	Any of the four PWM cables not connected	Connect all four male to male servo cables between your receiver and Aura.
	Any of four PWM cables connected to incorrect ports	Connect all cables to the proper ports. Reference the diagram on the PWM receiver connections page of this manual.
	Polarity of any PWM cables incorrect	Reconnect servo cables with the proper polarity.
PWM Receiver Connection type, and cannot get orange + green LED on Aura, and no control of model	Receiver not bound and/or outputting PWM servo pulses	Bind receiver per manufacturer's instructions and verify with a servo to ensure PWM signal is output from each channel as required.

LIMITED WARRANTY

Warranty Coverage

Flex Innovations, Inc. and its authorized resellers ("Flex") warrant to the original purchaser that the product purchased (the "Product") it will be free from defects in materials and workmanship at the date of purchase.

Outside of Coverage

This warranty is not transferable and does not cover:

- (a) Products with more than 45 days after purchased date.
- (b) Damage due to acts of God, accident, misuse, abuse, negligence, commercial use, or due to improper use, installation, operation or maintenance
- (c) Modification of or to any part of the Product.
- (d) Product not compliant with applicable technical regulations.
- (e) Shipping damage
- (f) Cosmetic damage
- (g) Products that have been partially, or fully assembled

OTHER THAN THE EXPRESS WARRANTY ABOVE, FLEX MAKES NO OTHER WARRANTY OR REPRESENTATION, AND HERBY DISCLAIMS ANY AND ALL IMPLIED WARRANTIES, INCLUDING, WITHOUT LIMITATION, THE IMPLIED WARRANTIES OF NONINFRINGEMENT, MERCHANTABILITY AND FITNESS FOR A PARTICULAR PURPOSE. THE PURCHASER ACKNOWLEDGES THAT THEY ALONE HAVE DETERMINED THAT THE PRODUCT WILL SUITABLY MEET THE REQUIREMENTS OF THE PURCHASER'S INTENDED USE.

Purchaser's Solution

Flex's sole obligation and purchaser's sole and exclusive remedy shall be that Flex will, at its option, either (i) service, or (ii) replace, any Product determined by Flex to be defective. Flex reserves the right to inspect any and all Product(s) involved in a warranty claim. Service or replacement decisions are at the sole discretion of Flex. Proof of purchase is required for all warranty claims. **SERVICE OR REPLACEMENT AS PROVIDED UNDER THIS WARRANTY IS THE PURCHASER'S SOLE AND EXCLUSIVE REMEDY.**

Limitation of Liability

FLEX SHALL NOT BE LIABLE FOR SPECIAL, INDIRECT, INCIDENTAL OR CONSEQUENTIAL DAMAGES, LOSS OF PROFITS OR PRODUCTION OR COMMERCIAL LOSS IN ANY WAY, REGARDLESS OF WHETHER SUCH CLAIM IS BASED IN CONTRACT, WARRANTY, TORT, NEGLIGENCE, STRICT LIABILITY OR ANY OTHER THEORY OF LIABILITY, EVEN IF FLEX HAS BEEN ADVISED OF THE POSSIBILITY OF SUCH DAMAGES.

Further, in no event shall the liability of Flex exceed the individual price of the Product on which liability is asserted. As Flex has no control over use, setup, assembly, modification or misuse, no liability shall be assumed nor accepted for any resulting damage or injury. By the act of use, setup or assembly, the user accepts all resulting liability. If you as the purchaser or user are not prepared to accept the liability associated with the use of the Product, purchaser is advised to return the Product immediately in new and unused condition to the place of purchase.

Law

these terms are governed by Florida law (without regard to conflict of law principals). This warranty gives you specific legal rights, and you may also have other rights which vary from state to state. **FLEX RESERVES THE RIGHT TO MODIFY THIS WARRANTY AT ANY TIME WITHOUT PRIOR NOTICE.**

Questions & Assistance

Visit www.flexinnovations.com/articles.asp?ID=269 to find customer support in your region.

Inspection or Services

If this Product needs to be inspected or serviced and is compliant in the region you live and use the Product in, please contact your regional Flex authorized reseller. Pack the Product securely using a shipping carton. Please note that original boxes need to be included, but are not designed to withstand the rigors of shipping without additional protection. Ship via a carrier that provides tracking and insurance for lost or damaged parcels, as Flex is not responsible for merchandise until it arrives and is accepted at our facility.

Warranty Requirements

For Warranty consideration, you must include your original sales receipt verifying the proof of purchase date, original packaging materials, including the shipping carton. Provided warranty conditions have been met, your Product will be replaced free of charge. Shipping charges are as follows: shipping to Flex paid by customer, shipping to customer paid by Flex. Service or replacement decisions are at the sole discretion of Flex.

COMPLIANCE INFORMATION FOR THE EUROPEAN UNION



Declaration of Conformity (In accordance with ISO/IEC 17050-1)

Product(s): RV-8 Super PNP
RV-8 Night Version Super PNP

Item Number(s): FPM3570
FPM3580

The object of declaration described above is in conformity with the requirements of the specifications listed below, following the provisions of the EMC Directive 2004/108/EC.

EN 55022: 2010+AC:2011
EN 55024: 2010
EN 61000-3-2: 2006+A2:2009
EN 61000-3-3: 2013

EN 61000-6-3: 2007/A1:2011
EN 61000-6-1: 2007



Instructions for disposal of WEEE by users in the European Union

This product must not be disposed of with other waste. Instead, it is the user's responsibility to dispose of their waste equipment by handing it over to a designated collections point for the recycling of waste and electronic equipment. The separate collection and recycling of your waste equipment at the time of disposal will help to conserve natural resources and ensure that it is recycled in a manner that protects human health and the environment. For more information about where to drop off your waste equipment for recycling, please contact your local city office, your household waste disposal service or where you purchased this product.

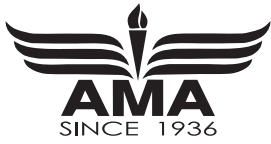

Academy of Model Aeronautics National Model Aircraft Safety Code

Effective January 1, 2015

- A. GENERAL:** A model aircraft is a non-human-carrying aircraft capable of sustained flight in the atmosphere. It may not exceed limitations of this code and is intended exclusively for sport, recreation, education and/or competition. All model flights must be conducted in accordance with this safety code and any additional rules specific to the flying site.
- Model aircraft will not be flown:
 - In a careless or reckless manner.
 - At a location where model aircraft activities are prohibited.
 - Model aircraft pilots will:
 - Yield the right of way to all human-carrying aircraft.
 - See and avoid all aircraft and a spotter must be used when appropriate. (AMA Document #540-D.)
 - Not fly higher than approximately 400 feet above ground level within three (3) miles of an airport without notifying the airport operator.
 - Not interfere with operations and traffic patterns at any airport, heliport or seaplane base except where there is a mixed use agreement.
 - Not exceed a takeoff weight, including fuel, of 55 pounds unless in compliance with the AMA Large Model Airplane program. (AMA Document 520-A.)
 - Ensure the aircraft is identified with the name and address or AMA number of the owner on the inside of affixed to the outside of the model aircraft. (This does not apply to model aircraft flown indoors.)
 - Not operate aircraft with metal-blade propellers or with gaseous boosts except for helicopters operated under the provisions of AMA Document #555.
 - Not operate model aircraft while under the influence of alcohol or while using any drug that could adversely affect the pilot's ability to safely control the model.
 - Not operate model aircraft carrying pyrotechnic devices that explode or burn, or any device which propels a projectile or drops any object that creates hazard to persons or property.

Exceptions:

- Free Flight fuses or devices that burn producing smoke and are securely attached to the model aircraft during flight.
 - Rocket motors (using solid propellant) up to a G-series size may be used provided they remain attached to the model during flight. Model rockets may be flown in accordance with the National Model Rocketry Safety Code but may not be launched from model aircraft.
 - Officially designated AMA Air Show Teams (AST) are authorized to use devices and practices as defined within the Team AMA Program Document. (AMA Document #718.)
- Not operate a turbine-powered aircraft, unless in compliance with
 - the AMA turbine regulations. (AMA Document #510-A.)
 - Model aircraft will not be flown in AMA sanctioned events, air shows or model demonstrations unless:
 - The aircraft, control system and pilot skills have successfully demonstrated all maneuvers intended or anticipated prior to the specific event.
 - An inexperienced pilot is assisted by an experienced pilot.
 - When and where required by rule, helmets must be properly worn and fastened. They must be OSHA, DOT, ANSI, SNELL or NOCSAE approved or comply with comparable standards.

B. RADIO CONTROL (RC)

- All pilots shall avoid flying directly over unprotected people, vessels, vehicles or structures and shall avoid endangerment of life and property of others.
- A successful radio equipment ground-range check in accordance with manufacturer's recommendations will be completed before the first flight of a new or repaired model aircraft. At all flying sites a safety line(s) must be established in front of which all flying takes place. (AMA Document #706.)
 - Only personnel associated with flying the model aircraft are allowed at or in front of the safety line.
 - At air shows or demonstrations, a straight safety line must be established.
 - An area away from the safety line must be maintained for spectators.
 - Intentional flying behind the safety line is prohibited.

- RC model aircraft must use the radio-control frequencies currently allowed by the Federal Communications Commission (FCC). Only individuals properly licensed by the FCC are authorized to operate equipment on Amateur Band frequencies.
- RC model aircraft will not knowingly operate within three (3) miles of any pre-existing flying site without a frequency-management agreement. (AMA Documents #922 and #923)
- With the exception of events flown under official AMA Competition Regulations, excluding takeoff and landing, no powered model may be flown outdoors closer than 25 feet to any individual, except for the pilot and the pilot's helper(s) located at the flightline.
- Under no circumstances may a pilot or other person touch an outdoor model aircraft in flight while it is still under power, except to divert it from striking an individual.
- RC night flying requires a lighting system providing the pilot with a clear view of the model's attitude and orientation at all times. Hand-held illumination systems are inadequate for night flying operations.
- The pilot of an RC model aircraft shall:
 - Maintain control during the entire flight, maintaining visual contact without enhancement other than by corrective lenses prescribed for the pilot.
 - Fly using the assistance of a camera or First-Person-View (FPV) only in accordance with the procedures outlined in AMA Document #550.
 - Fly using the assistance of autopilot or stabilization system only in accordance with the procedures outlined in AMA Document #560

C. FREE FLIGHT

- Must be at least 100 feet downwind of spectators and automobile parking when the model aircraft is launched.
- Launch area must be clear of all individuals except mechanics, officials, and other fliers.
- An effective device will be used to extinguish any fuse on the model aircraft after the fuse has completed its function.

D. CONTROL LINE

- The complete control system (including the safety thong where applicable) must have an inspection and pull test prior to flying.
- The pull test will be in accordance with the current Competition Regulations for the applicable model aircraft category.
- Model aircraft not fitting a specific category shall use those pull-test requirements as indicated for Control Line Precision Aerobatics.
- The flying area must be clear of all utility wires or poles and a model aircraft will not be flown closer than 50 feet to any above-ground electric utility lines.
- The flying area must be clear of all nonessential participants and spectators before the engine is started.

If you are not an AMA member, please consider joining. Founded in 1936 and open to anyone interested in model aviation, the AMA is the governing body for model aviation in the United States and sanctions over 2,000 competitions annually. Membership in the AMA provides liability insurance coverage, protects modelers' rights and interests, and is required to fly at most of the 2,700+ R/C sites nationwide.

Academy of Model Aeronautics
5161 East Memorial Drive
Muncie, IN 47302-9252
Toll Free (800) 435-9262
Fax (765) 741-0057

www.modelaircraft.org

POTENZA™

FLEX™
INNOVATIONS
INCORPORATED
www.flexinnovations.com

©2017 Flex Innovations, Inc.
Premier Aircraft™, Potenza™, and Top Value RC™ are trademarks or registered trademarks of Flex Innovations, Inc.
DSM®, DSM2™, and DSMX™ are trademarks or registered trademarks of Horizon Hobby LLC
Futaba™ is a registered trademark of Futaba Denshi Kogyo Kabushiki Kaisha Corporation of Japan.
Jeti™, UDI, and Jeti Model are trademarks or registered trademarks of Jelen, Ing. Stanislav of Czech Republic
Hitec is a trademark or registered trademark of Hitec RCD USA Inc.
Graupner HoTT® is a registered trademark of Graupner Co., Ltd.