



ЯK-54

Code : SEA 360

ASSEMBLY MANUAL



Specifications:

Wingspan ----- 73 in (185.0 cm)

Wing Area ----- 996.3 sp.in (64.3 dm²)

Weight ----- 11.5-12.3 lbs (5.2-5.6 kg)

Length ----- 65.7 in (167.0 cm)

Engine ----- 35-40cc

Servo----- 5 channels 6 servos

Motor 180/ 3000-3500watt/ ESC 80A-120A/ Lipo
12s 3300-4200mAh

Electric propeller 20x8-21x10



INTRODUCTION

Thank you for choosing the **YAK 54** ARTF by **SG MODELS**. The **YAK 54** was designed with the intermediate/advanced sport flyer in mind. It is a semi scale airplane which is easy to fly and quick to assemble. The airframe is conventionally built using balsa, plywood to make it stronger than the average ARTF, yet the design allows the aeroplane to be kept light. You will find that most of the work has been done for you already. The motor mount has been fitted and the hinges are pre-installed. Flying the **YAK 54** is simply a joy.

This instruction manual is designed to help you build a great flying aeroplane. Please read this manual thoroughly before starting assembly of your **YAK 54** Use the parts listing below to indentify all parts.

WARNING

Please be aware that this aeroplane is not a toy and if assembled or used incorrectly it is capable of causing injury to people or property. WHEN YOU FLY THIS AEROPLANE YOU ASSUME ALL RISK & REPONSIBILITY.

If you are inexperienced with basic R/C flight we strongly recommend you contact your R/C supplier and join your local R/C model Flying Club. R/C Model Flying Clubs offer a variety of training procedures designed to help the new pilot on his way to successful R/C flight. They will also be able to advise on any insurance and safety regulations that may apply.

KIT CONTENTS



KIT CONTENTS

SEA360 YAK 54

1. Fuselage
2. Wing set (2)
3. Tail set (2)
4. Cowling
5. Wing tube
6. landing gear
7. Fuel tank
8. Tail wheel
9. Spinner

ADDITIONAL ITEMS REQUIRED

- 35-40cc gasoline engine.
- Computer radio 5 channel with 6 servos.
- Glow plug to suit engine.
- Propeller to suit engine 20x8-21x10.
- Protective foam rubber for radio system.

TOOLS & SUPPLIES NEEDED

- Thin cyanoacrylate glue.
- Medium cyanoacrylate glue.
- 30 minute epoxy.
- 5 minute epoxy.
- Hand or electric drill.
- Assorted drill bits.
- Modelling knife.
- Straight edge ruler.
- 2mm ball driver.
- Phillips head screwdriver.
- 220 grit sandpaper.
- 90° square or builder's triangle.
- Wire cutters.
- Masking tape & T-pins.
- Thread-lock.
- Paper towels.

HINGING THE AILERON

Note: *The control surfaces, including the ailerons, elevators, and rudder, are prehinged with hinges installed, but the hinges are not glued in place. It is imperative that you properly adhere the hinges in place per the steps that follow using a high-quality thin C/A glue.*

Carefully remove the aileron from one of the wing panels. Note the position of the hinges.

1.

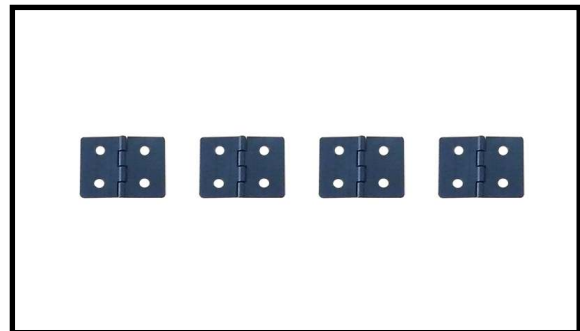

Prepare the aileron hinges by scuffing the area that will be inserted into the wing or flying surface with medium grit sandpaper. Be careful not to remove too much material. Use isopropyl alcohol, and a paper towel to remove any excess debris that remains on the hinges.

2.

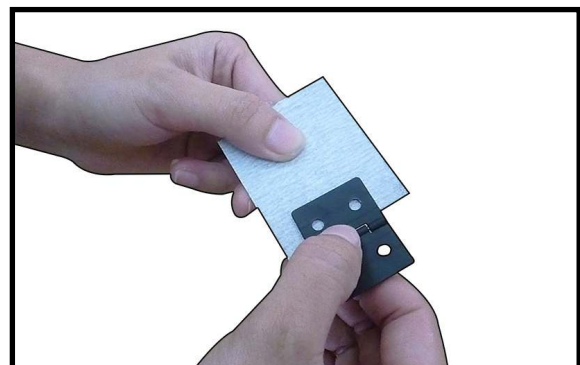

Mix a sufficient amount of 30-minute epoxy in a cup, and with a toothpick, smear epoxy in the hinge pockets of the wing panel and aileron. Slowly and carefully, insert each hinge into the wing panel. Partially remove and re-install the hinge to ensure that you've completely coated it with glue. Clean up any excess epoxy with isopropyl alcohol, and tape the aileron in place to cure.

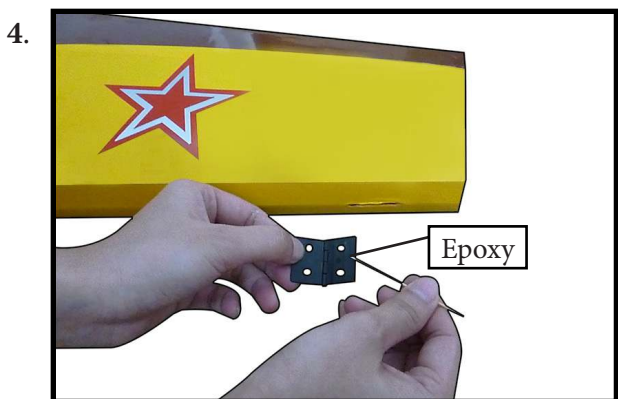
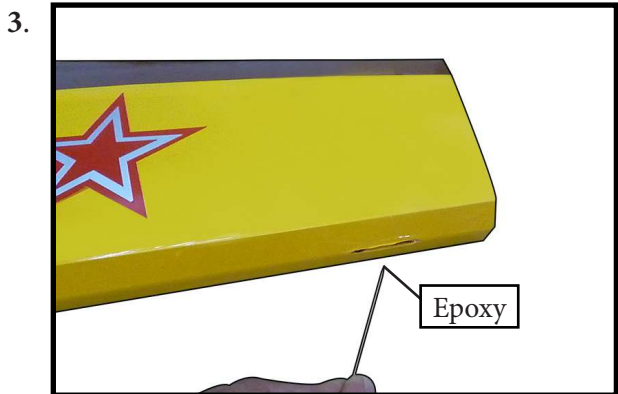

Press the aileron and wing together such that less than a 1/64" hinge line gap exists between the aileron and wing. The bevels should virtually touch. Use a paper towel and rubbing alcohol to wipe away any visible epoxy around the hinges.



Allow the glue to fully cure for at least 6 hours.

When fully cured, move each control surface throughout its travel range several times to break away any epoxy in the hinge. Be sure to deflect the surface fully.

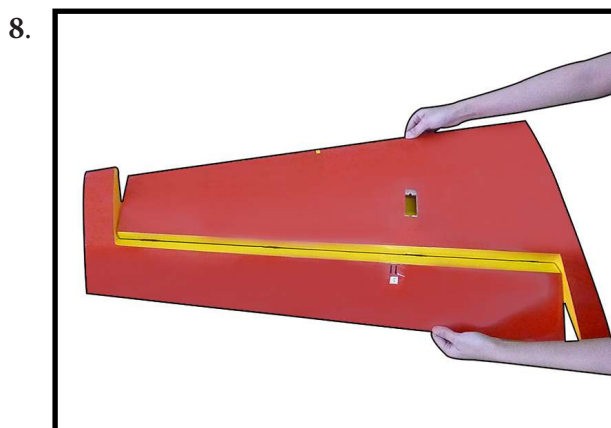

Note : *Work the aileron up and down several times to "work in" the hinges and check for proper movement.*

INSTALL THE AILERONS CONTROL HORN

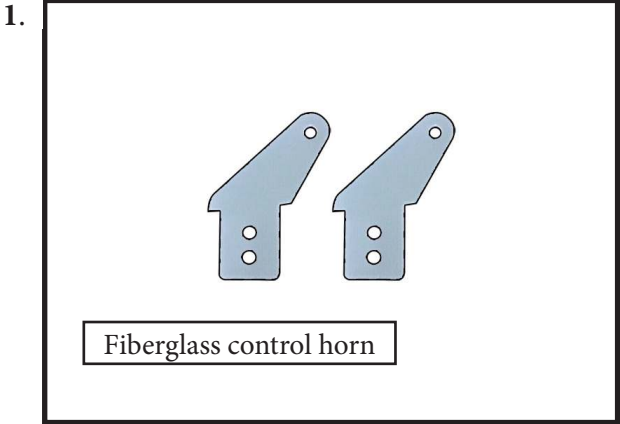

Prepare the aileron control horns by sanding the section that extends into the control surface with medium grit sand paper. Use isopropyl alcohol and a paper towel to remove any excess debris from the control horn.

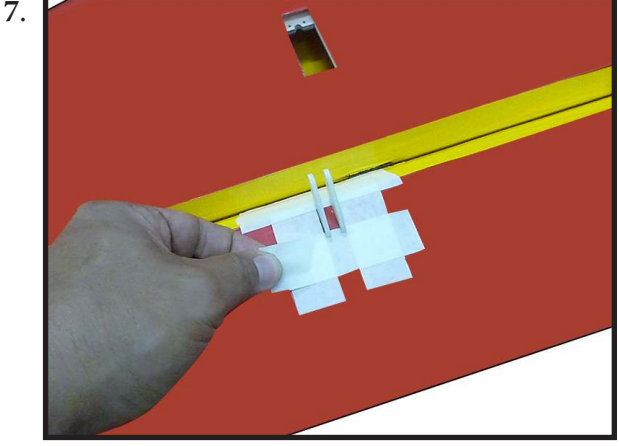
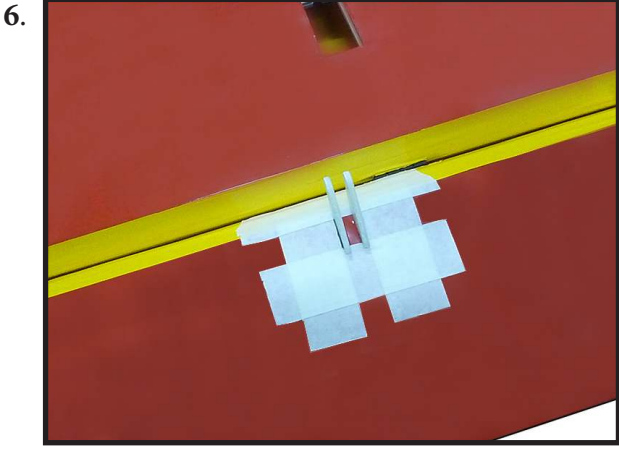
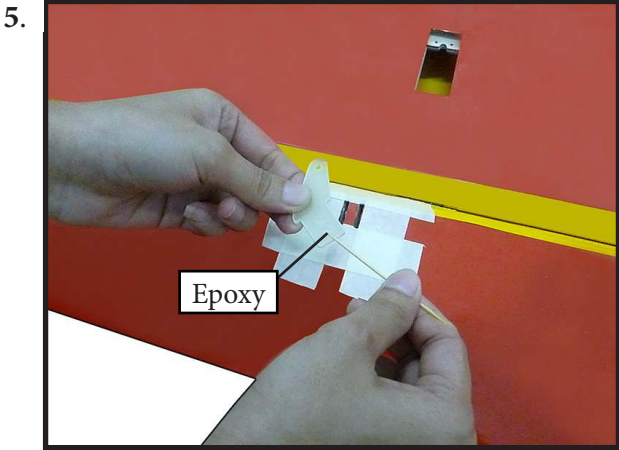
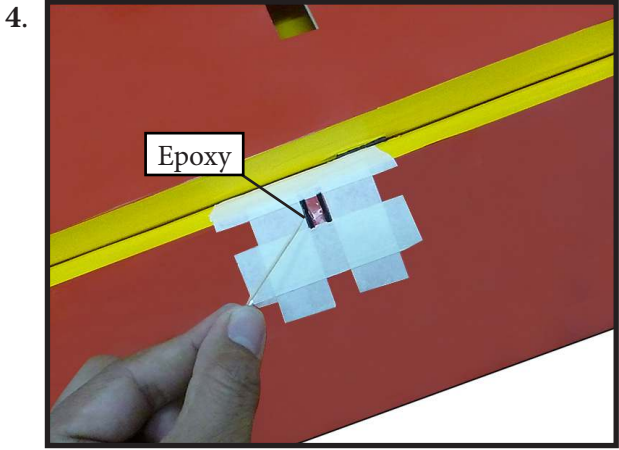
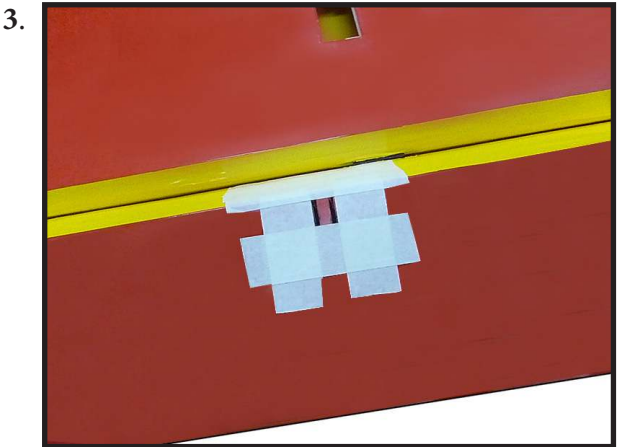
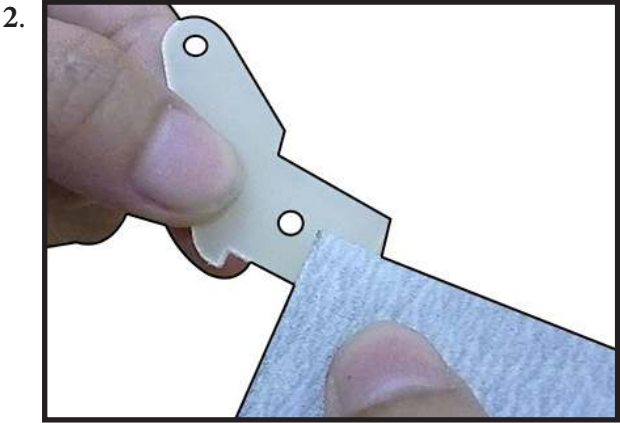

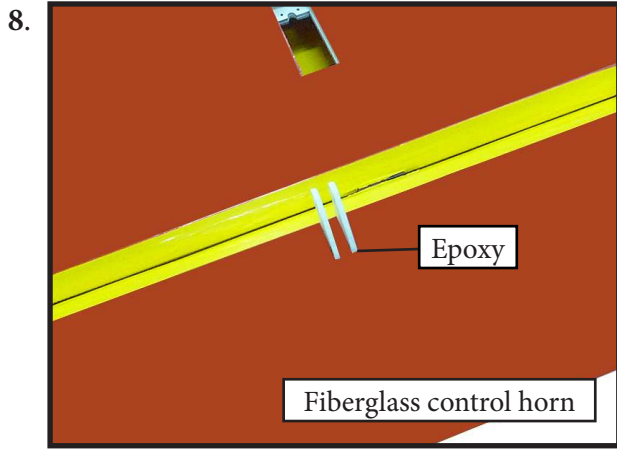

Attach the extension to the servo lead and secure with Safety Clip, safety wire, tape or other method. Ensure the plugs will not come apart from vibration or light tension.

INSTALLING THE AILERON SERVOS

Please study images below.



Minimum servo spec.
Torque : 333.00 oz-in (23.98 kg-cm) @ 6.0V; oz-in (29.02 kg-cm) @ 7.4V

NOTE : servos arm for aileron is not provided from manufacturer.

Layout the servo on the wing to test fit the installation and ensure servo lead is he correct length.

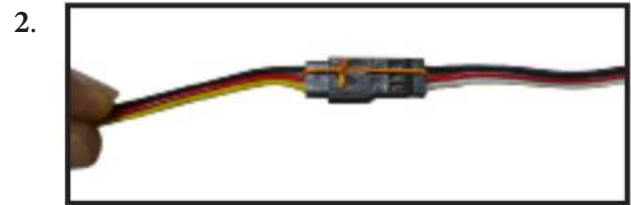

Fasten the pull string from the servo hole to the male plug of the servo extension.

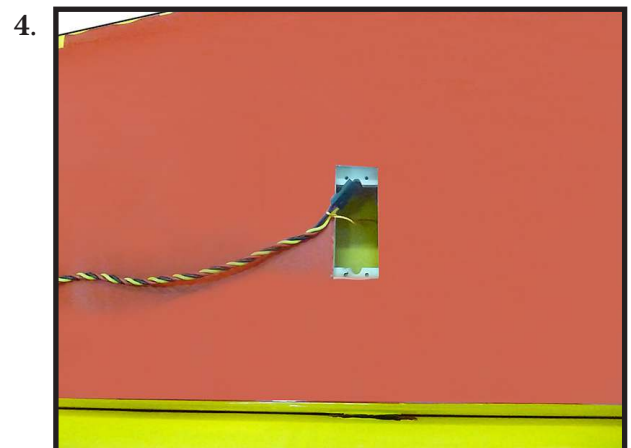

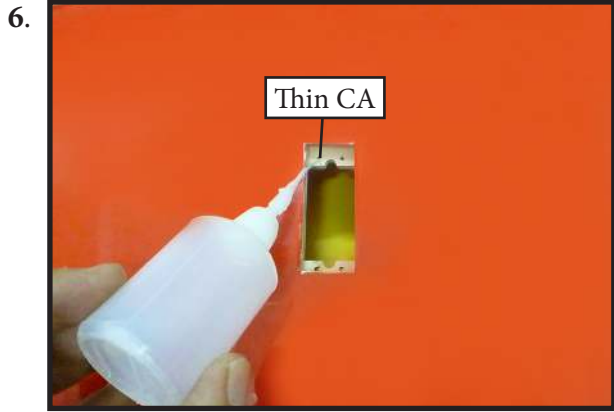

Install servo with servo mounting screws.

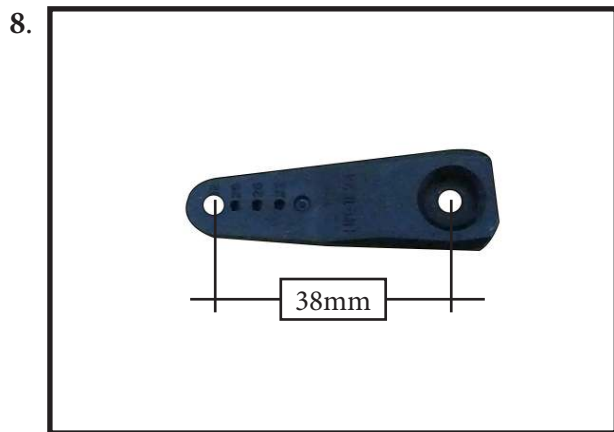

INSTALLING THE AILERON PUSHROD

Please study images below.

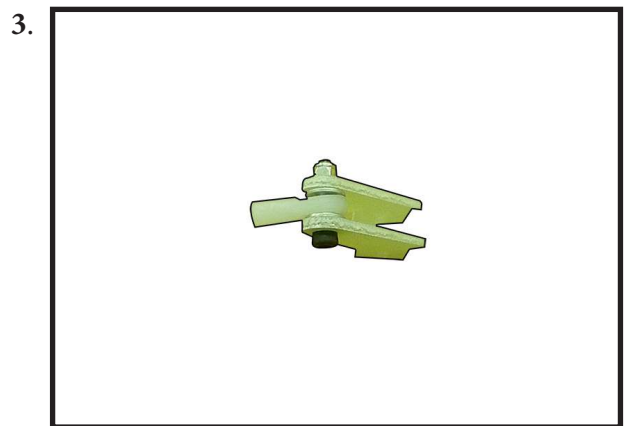
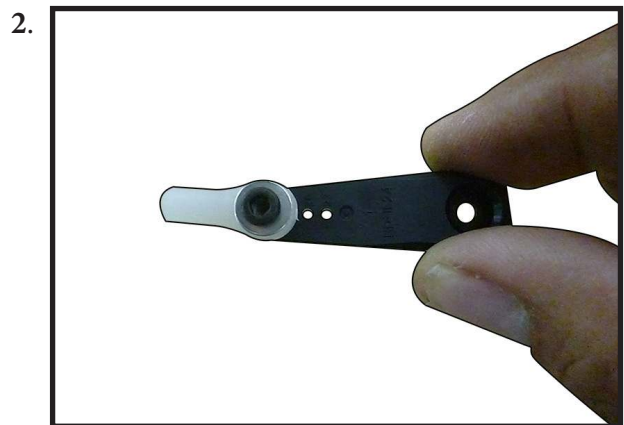
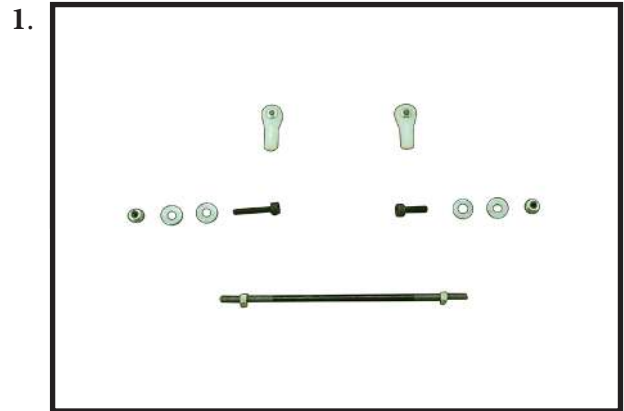

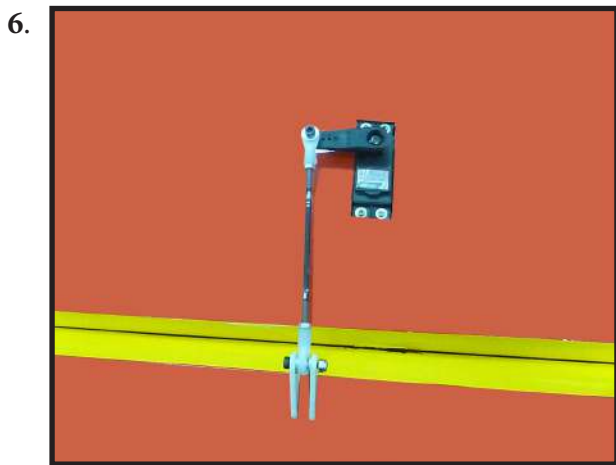
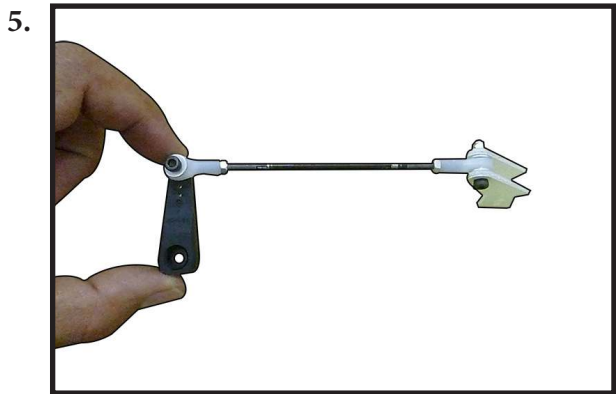
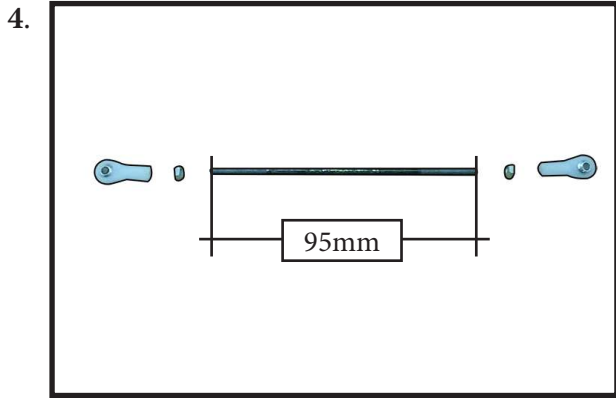

Repeat all the above steps for the other wing.



INSTALL HINGE FOR STABILIZER AND ELEVATOR

Please study images below.

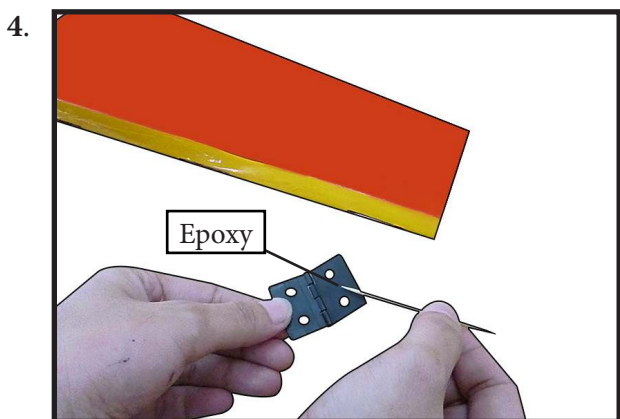
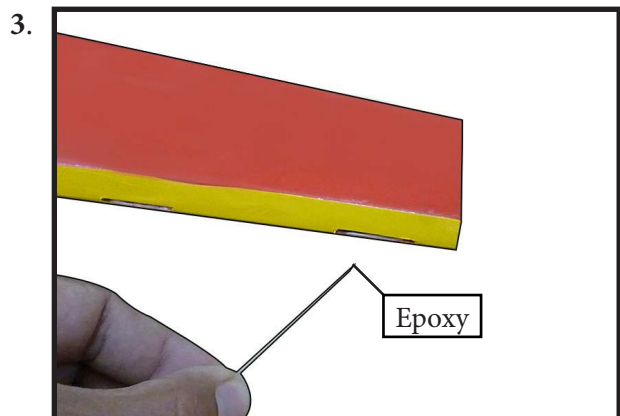
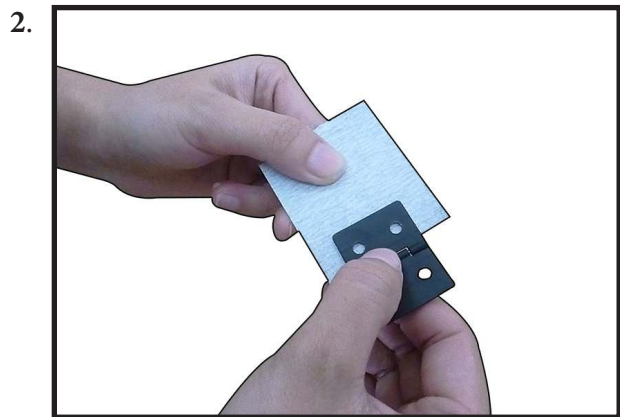
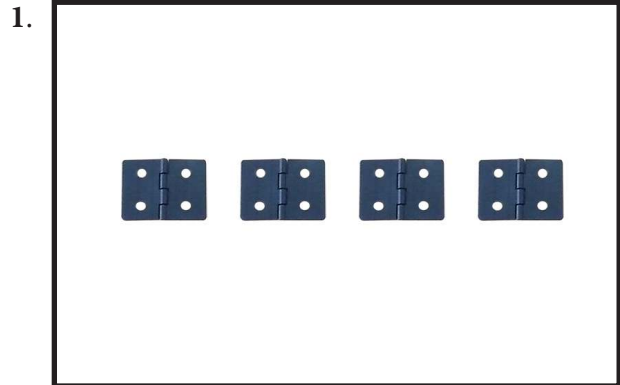

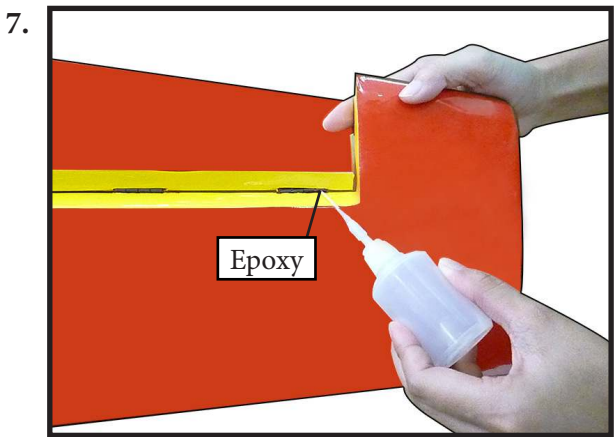
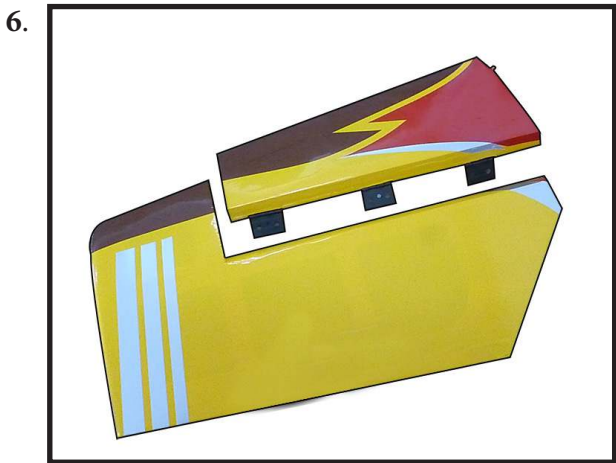
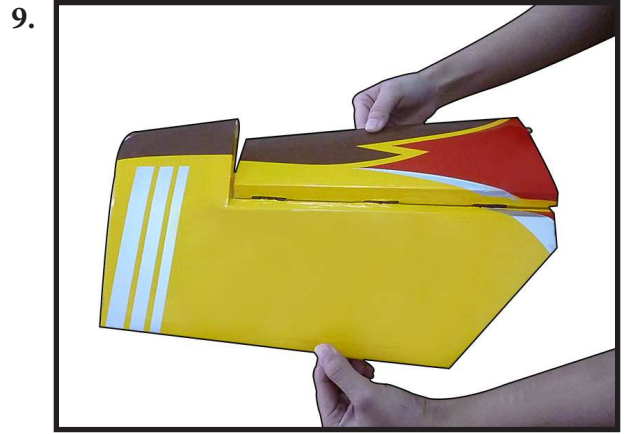

INSTALL ELEVATOR CONTROL HORN

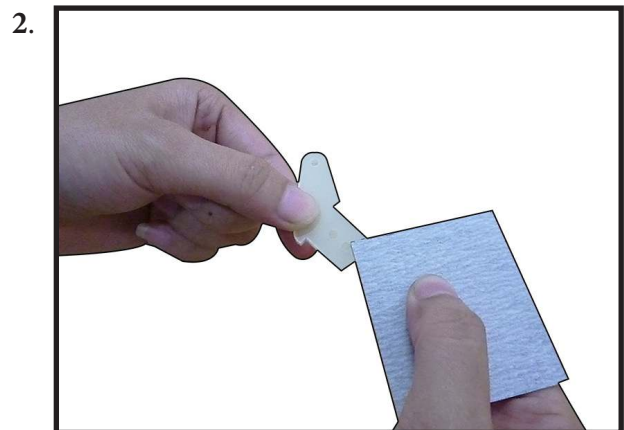
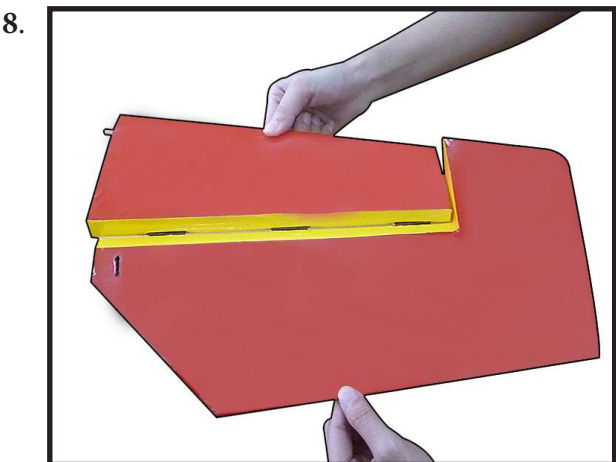
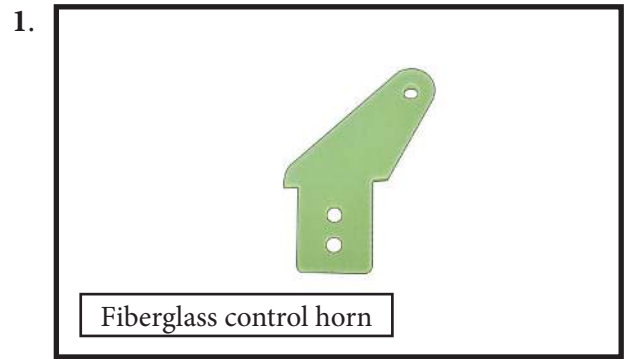

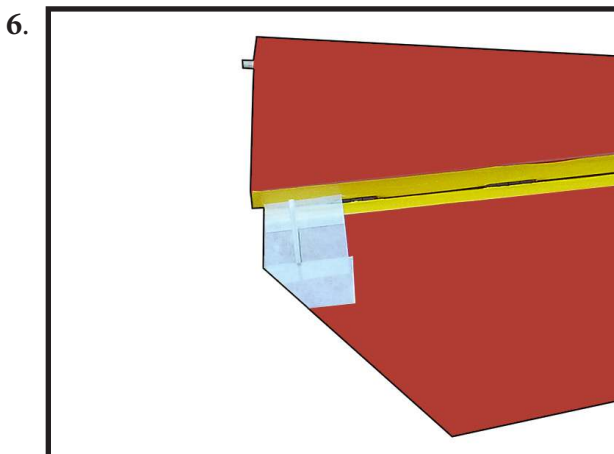
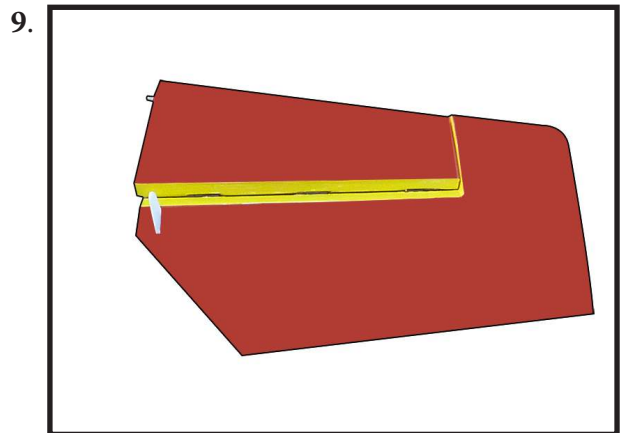
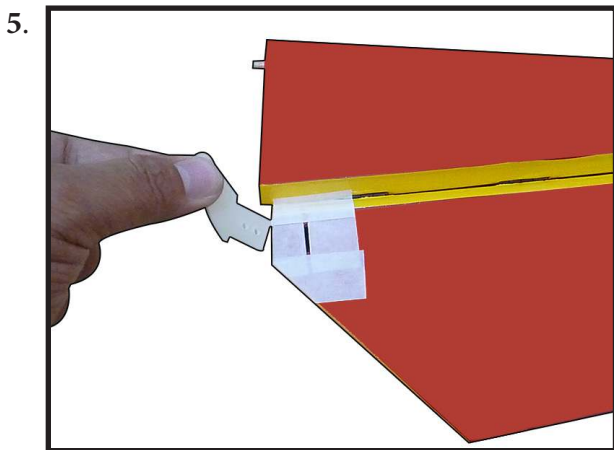
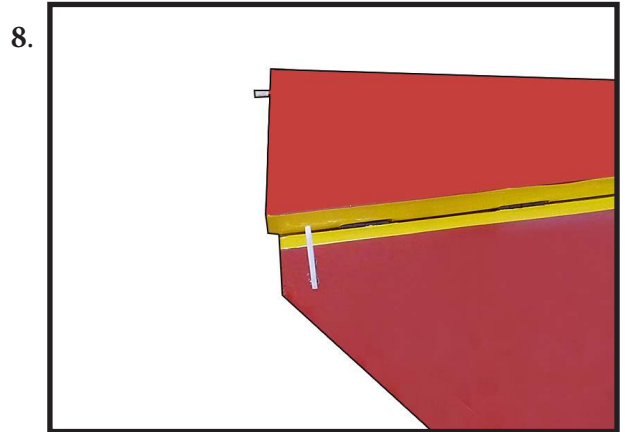
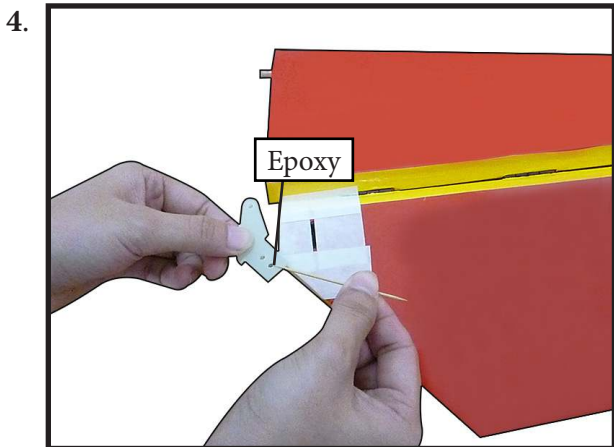
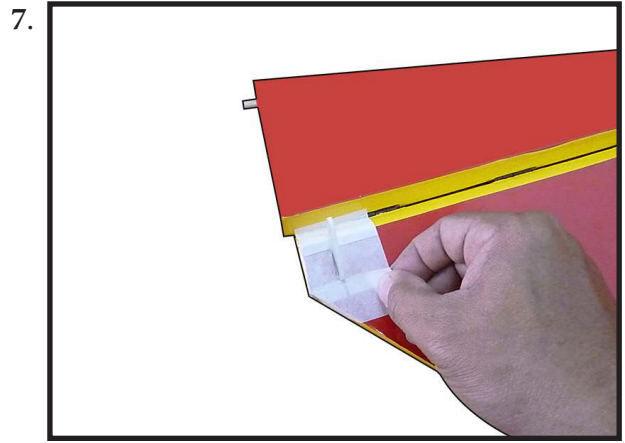
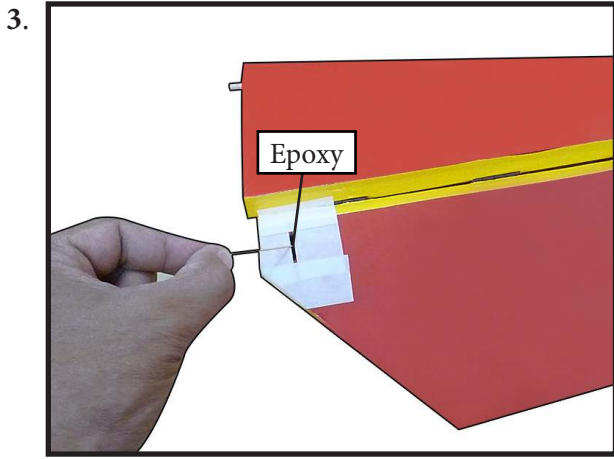

You cut horizontal tail sever hole.



11.



14.

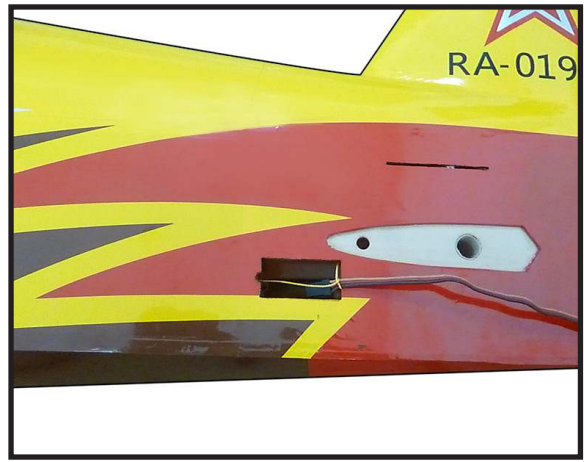

12.

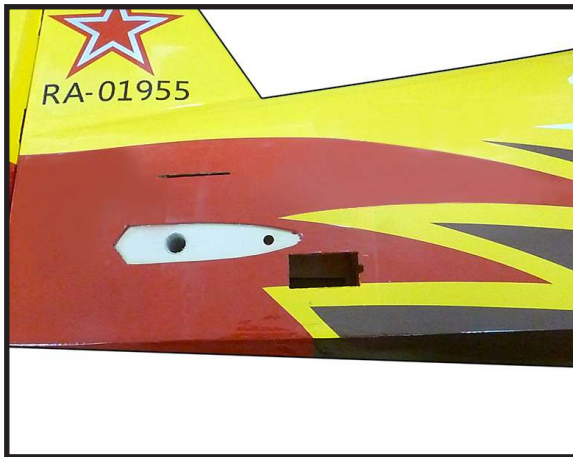

15.

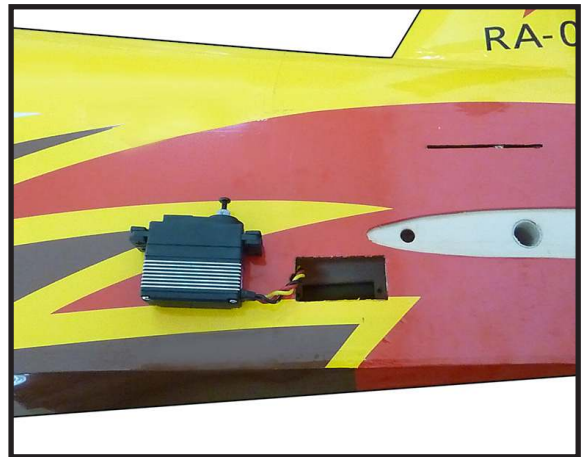

13.

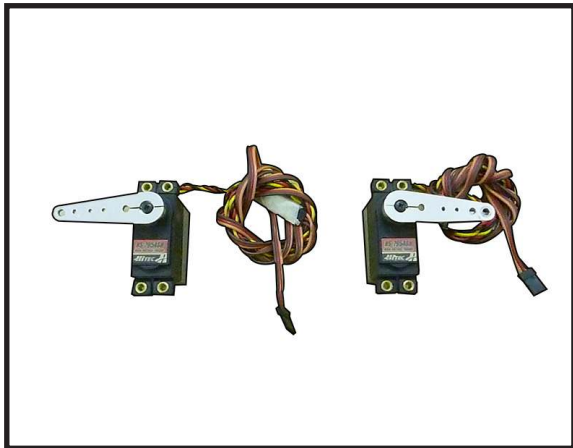

16.



Minimum servo spec.
Torque : 333.00 oz-in (23.98 kg-cm) @ 6.0V; oz-in (29.02 kg-cm) @ 7.4V

17.



INSTALL HINGE FOR RUDDER AND FIN

Please study images below.

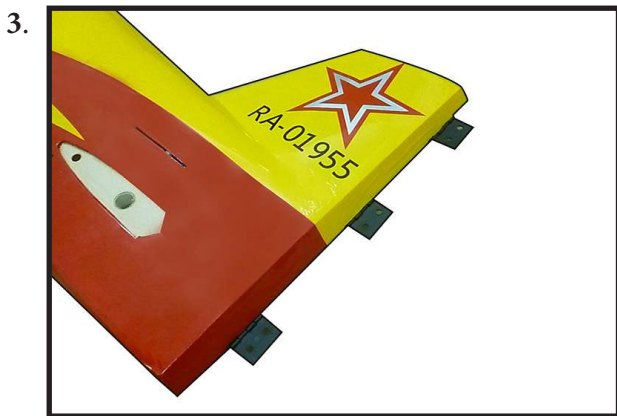
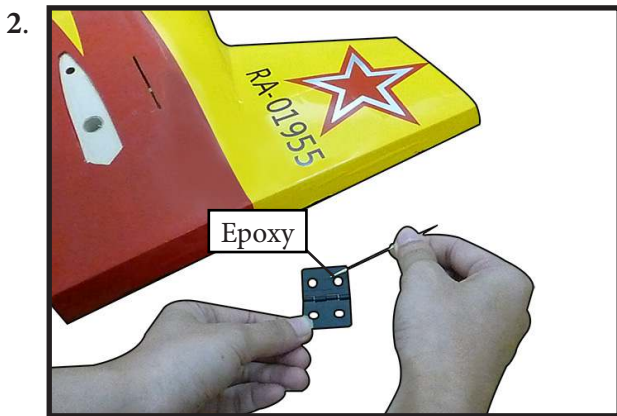

INSTALL RUDDER CONTROL HORN

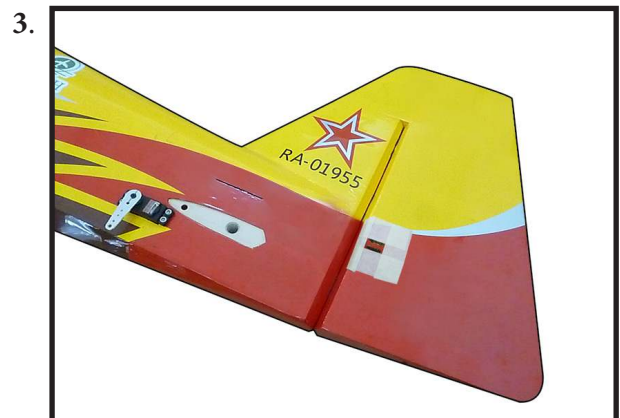
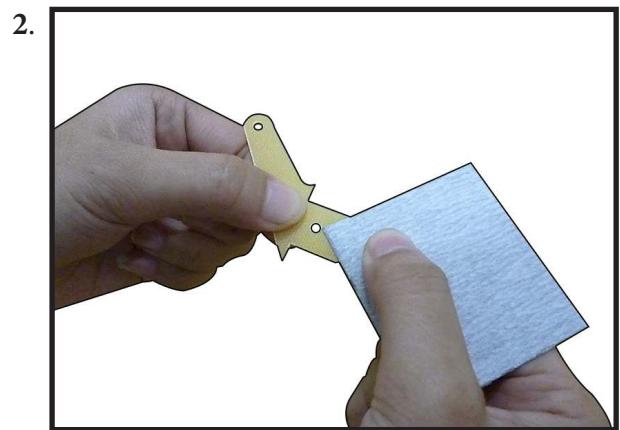
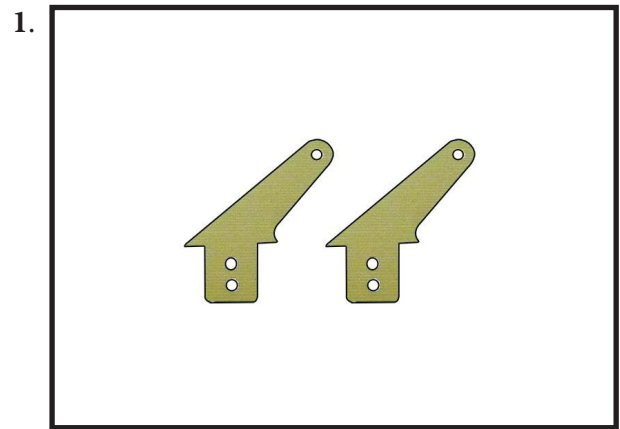

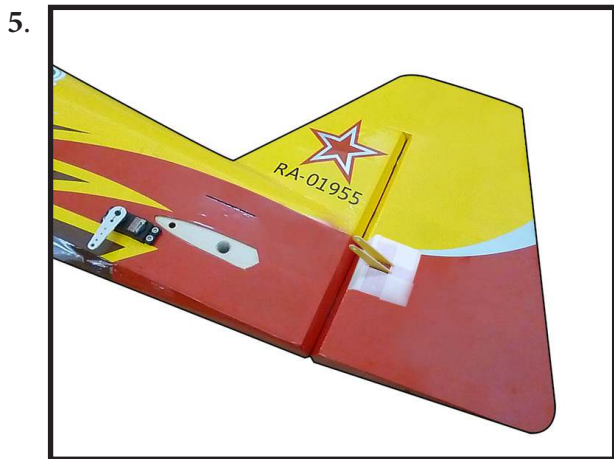
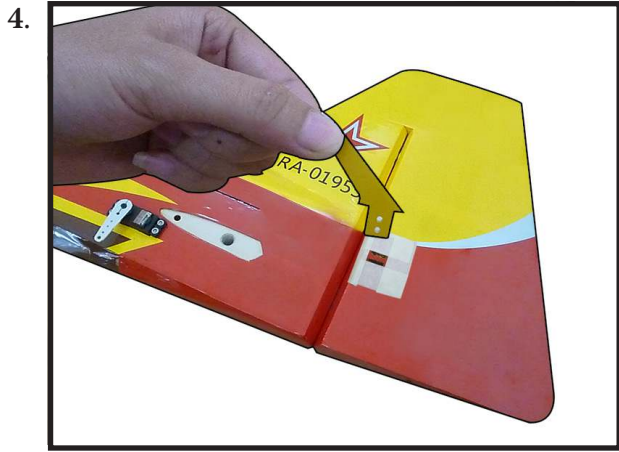

HORIZONTAL TAIL INSTALLATION

Please study images below.

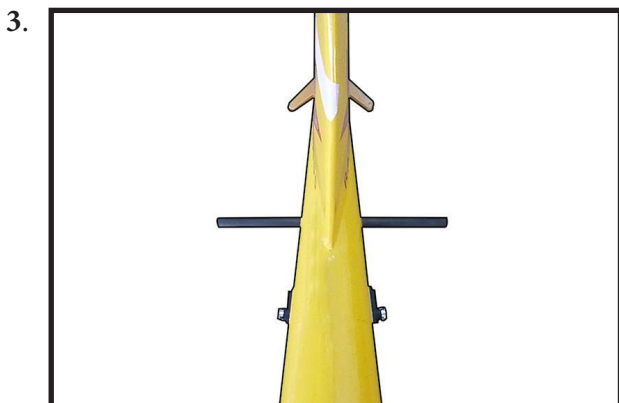
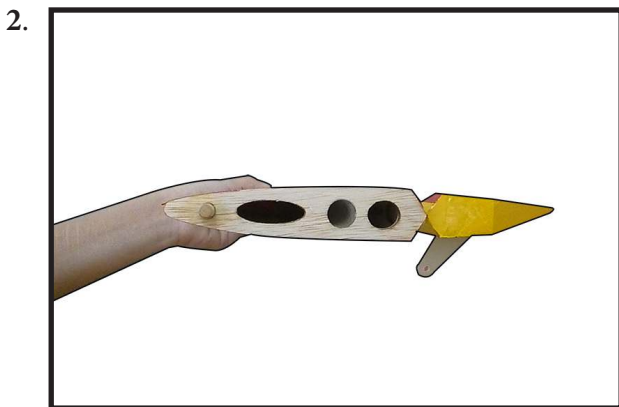
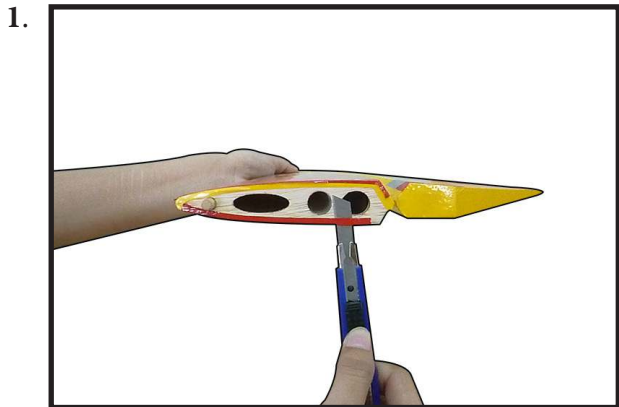
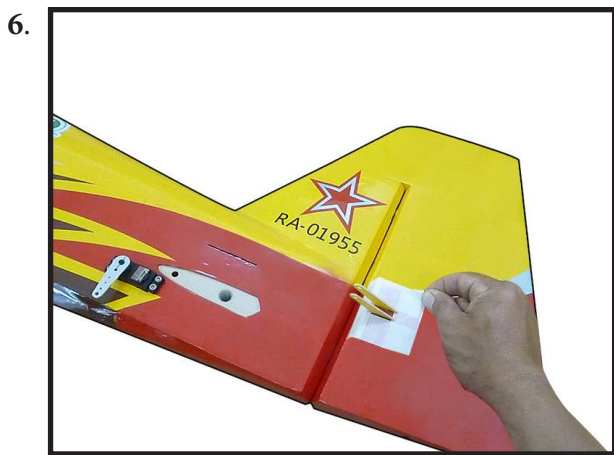

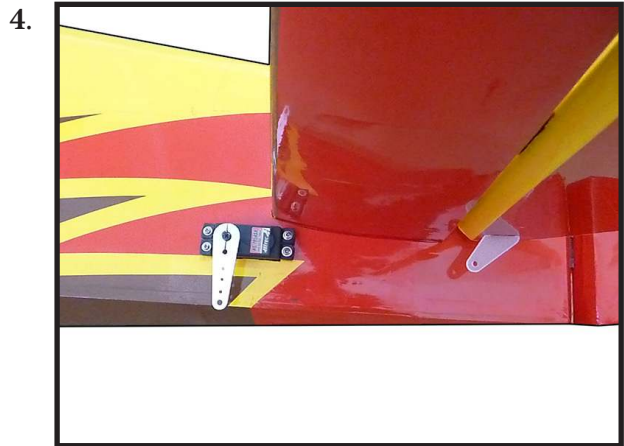
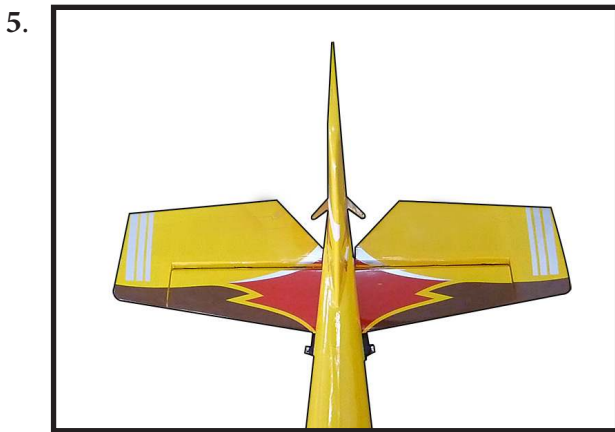
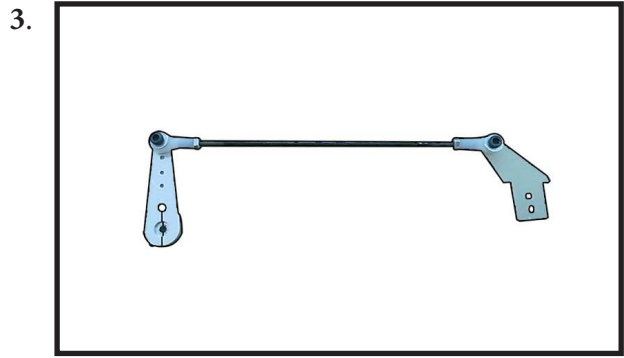

ELEVATOR PUSHROD INSTALLATION.

Please study images below.

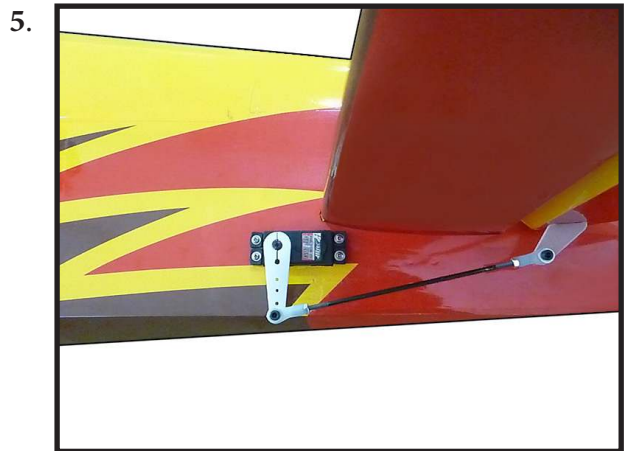
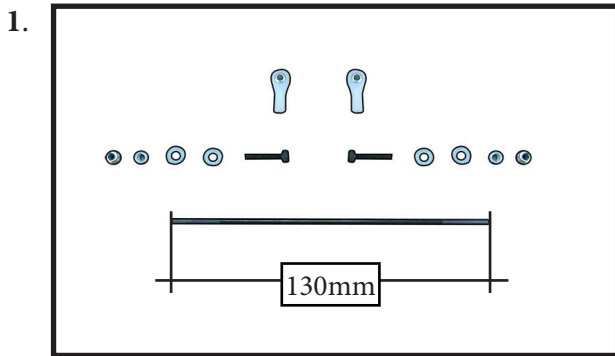

INSTALL RUDDER CABLE AND SERVO

NOTE : servos arm is not provided from manufacturer.

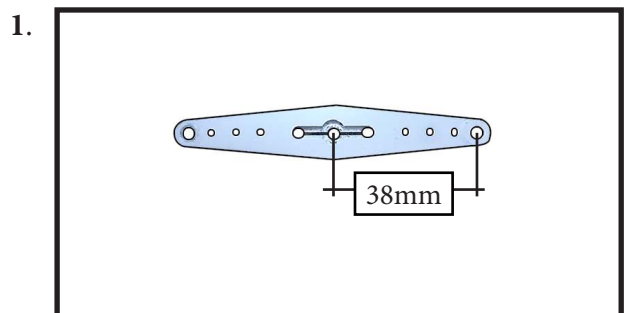
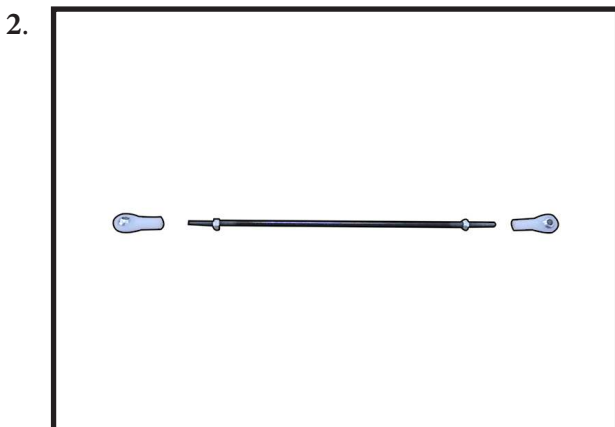

2.

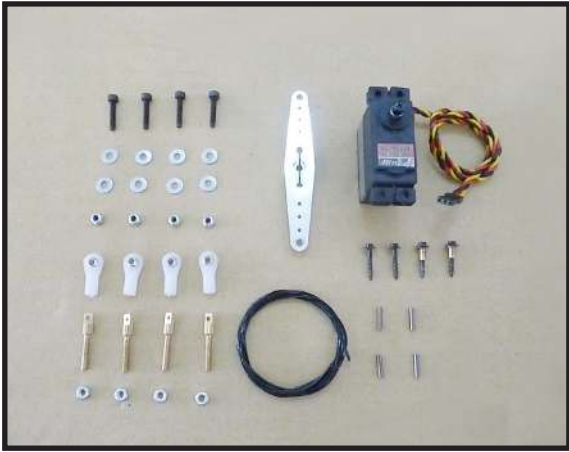

Tape the rudder balance tab to the top leading edge of the vertical fin in the neutral position as shown. This ensures the rudder is straight when the cables are attached.

3.



Thread the rudder cable through a brass swage tube, then the threaded coupler, and back through the brass swage tube on both sides. Pull light tension on the cable through the coupler on both sides as shown.

4.

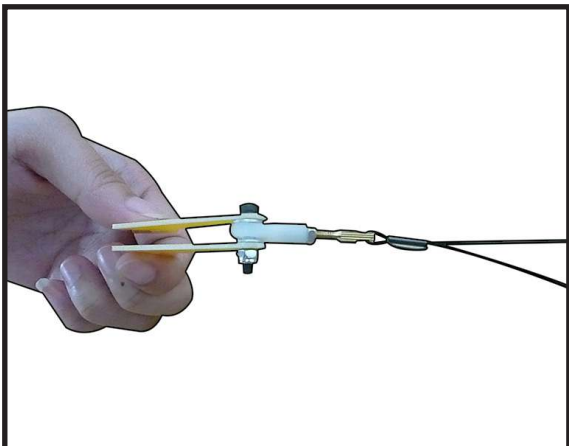

5.



Loop the cable back through the brass swage tube and tighten the second loop through the brass swage tube as shown.

6.



Crimp the brass tube with a crimping tool or pliers.

7.



Cut off excess cable as shown.

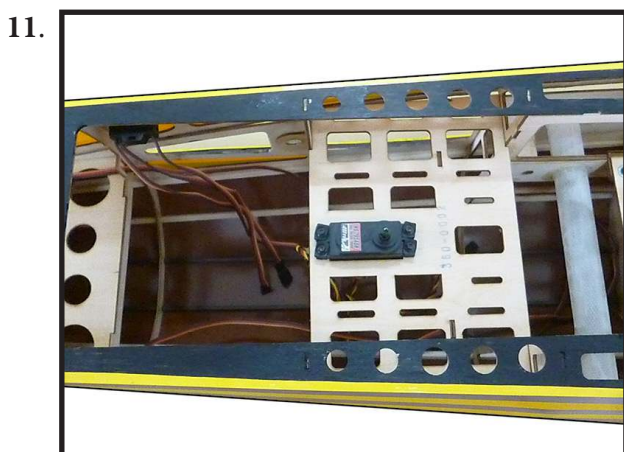
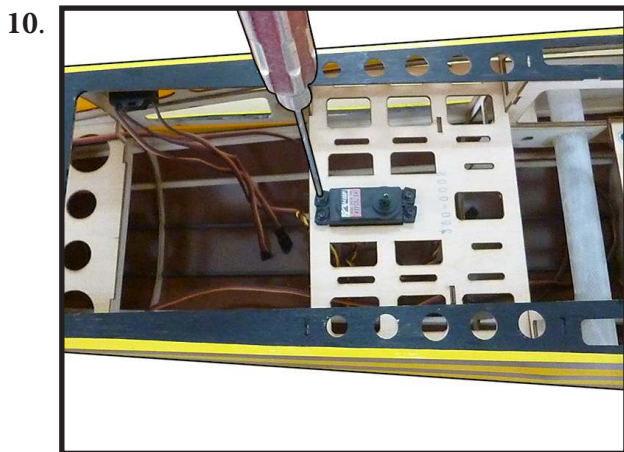

Feed one rudder cable through the pre installed cable exit tube in the rear of the fuse toward the front of the fuse. Repeat for other side.



Thread cable through brass swage tube.

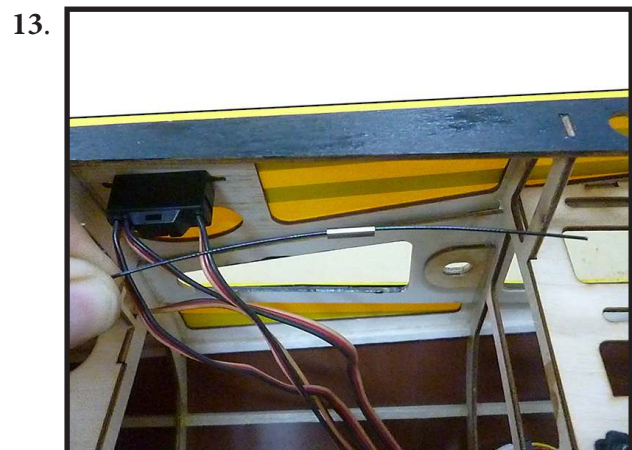

Thread cable through the threaded coupler hole, and back through the brass swage tube as shown.

Loop the cable back through the brass swage tube and pull tight.

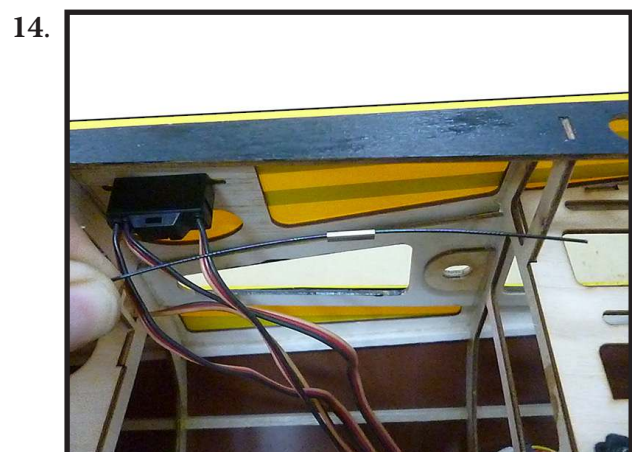

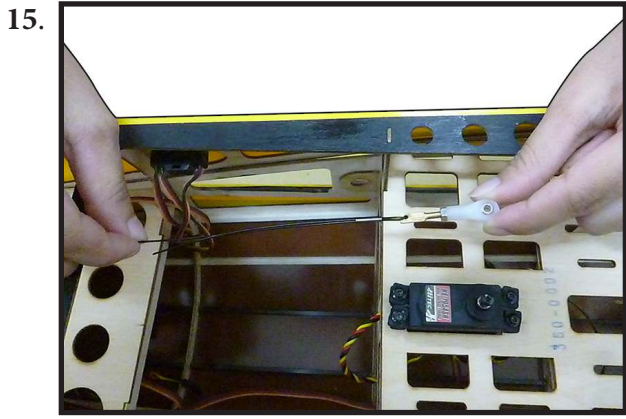

Crimp the brass swage tube with a crimping tool or pliers.

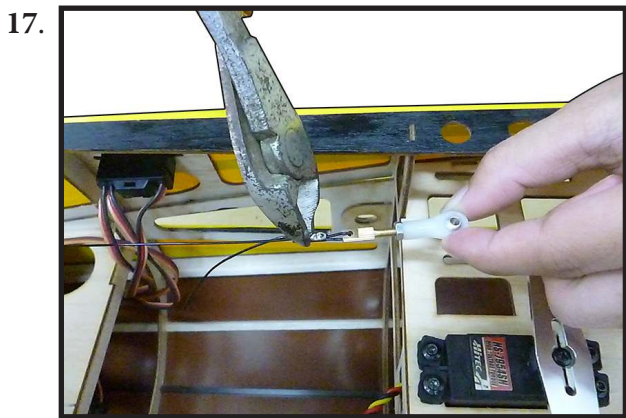

Cut off excess cable as shown.

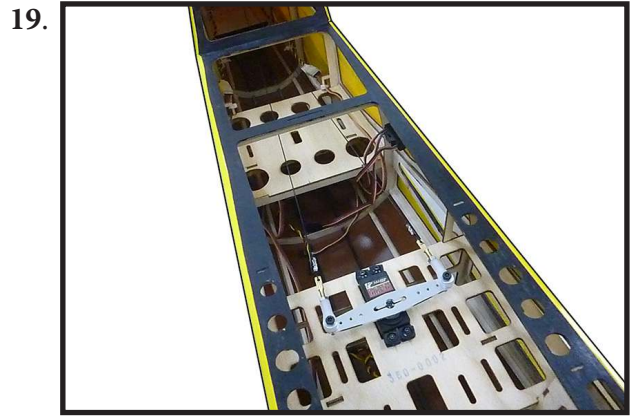

TAILWHEEL INSTALLATION

Locate items necessary to install tailwheel.

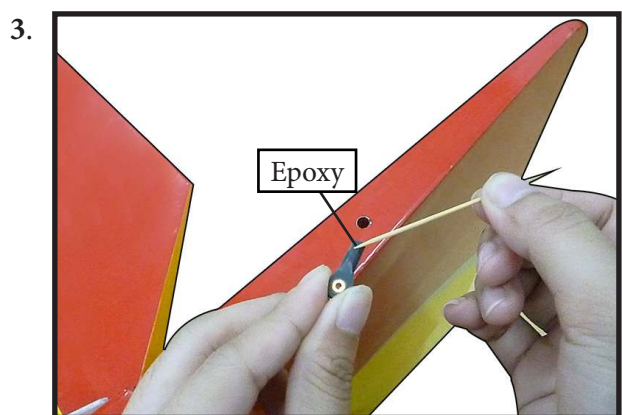
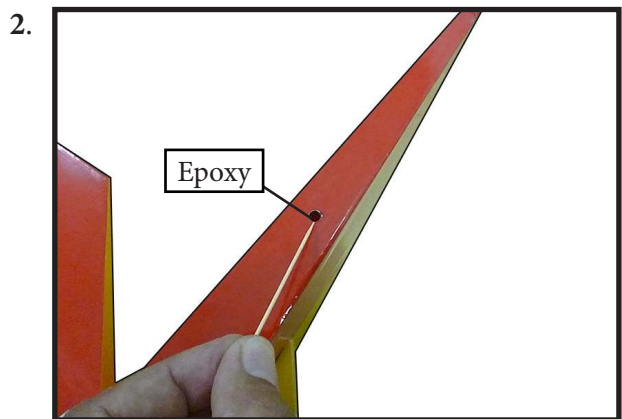
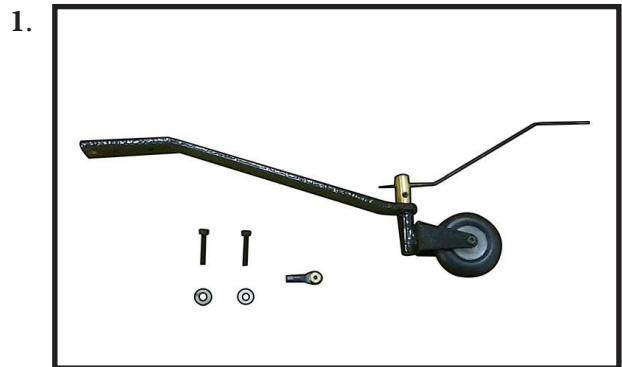

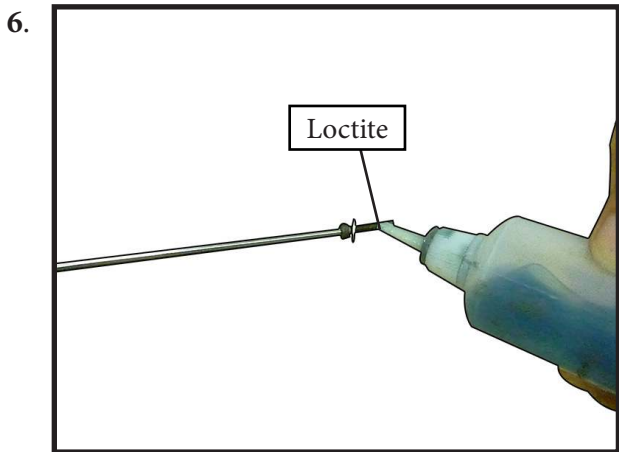
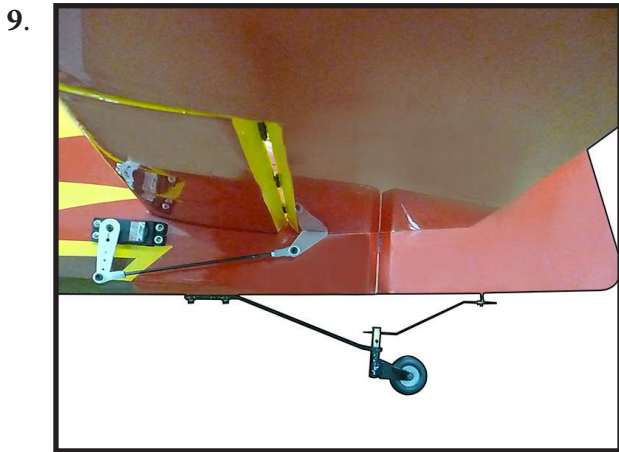
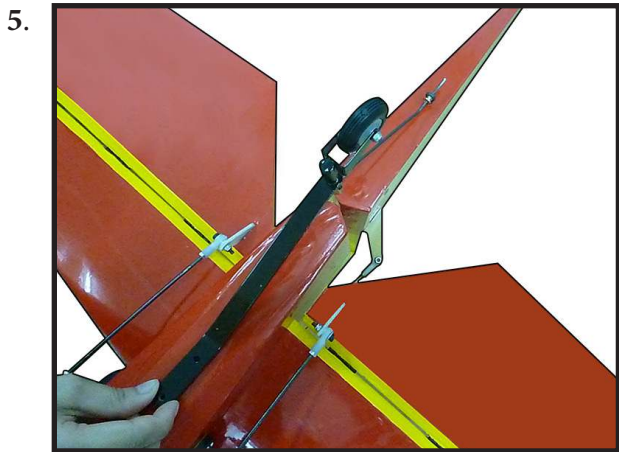
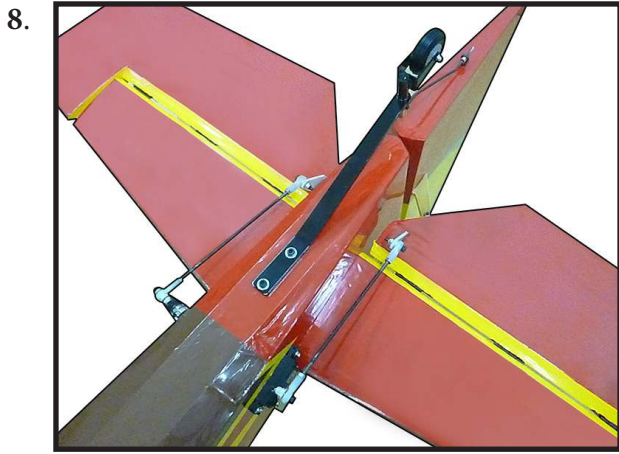
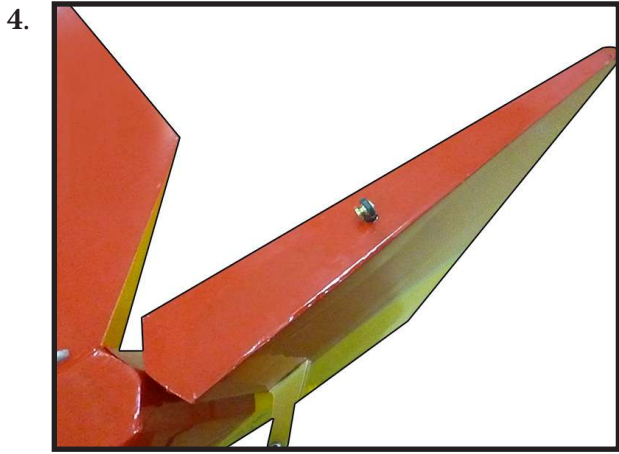

INSTALLING THE MAIN LANDING GEAR TO FUSELAGE

Please study images below.

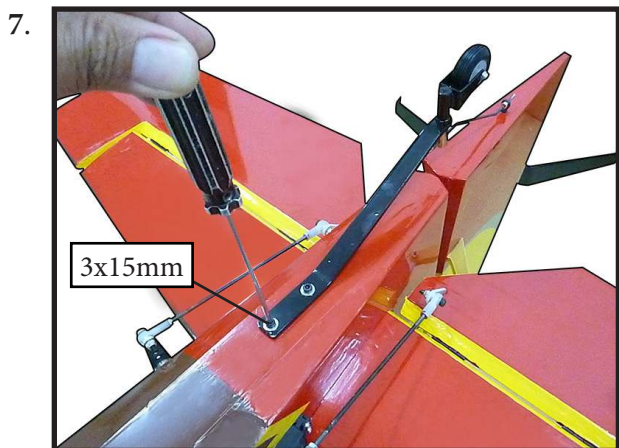

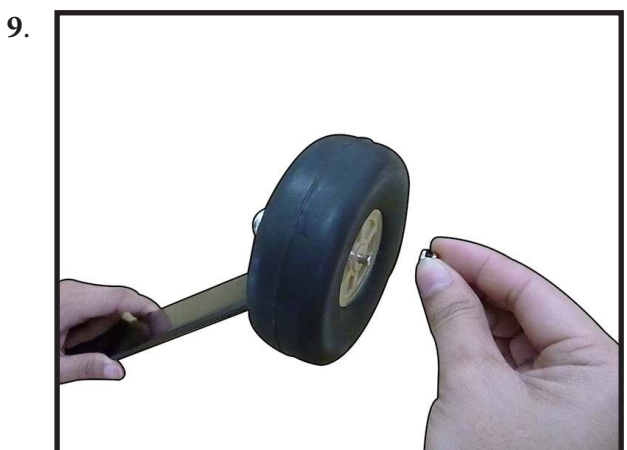
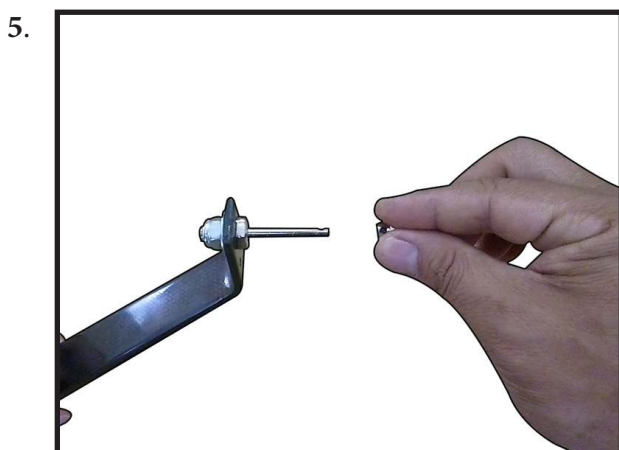
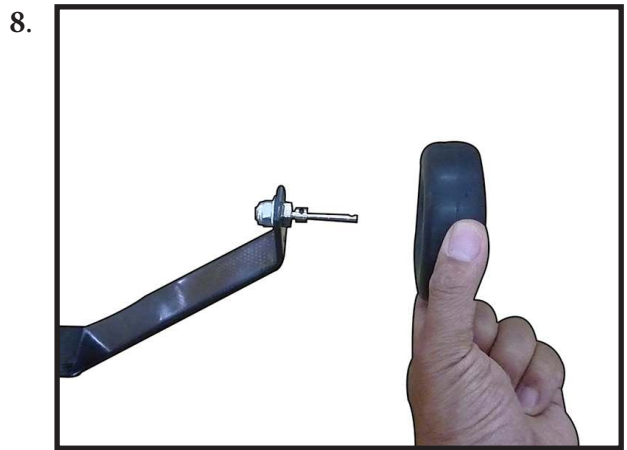
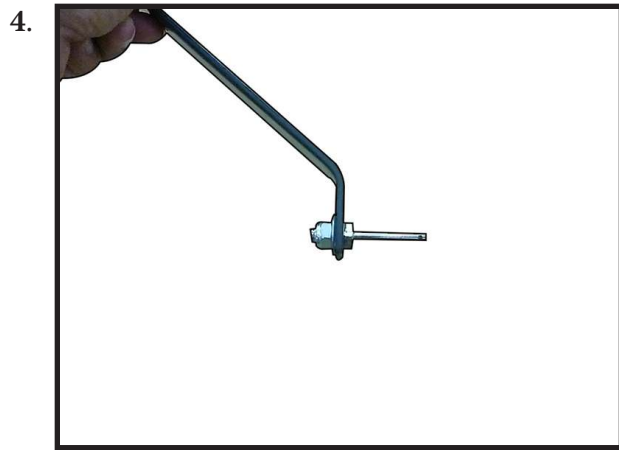
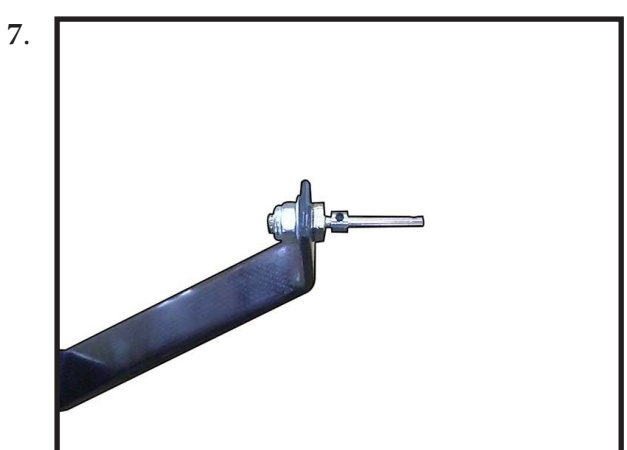
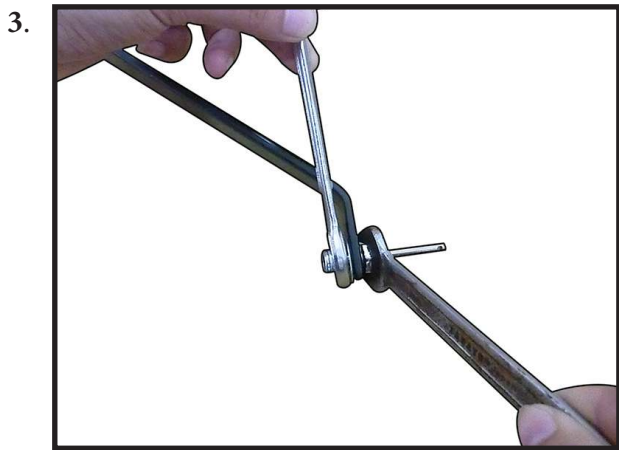
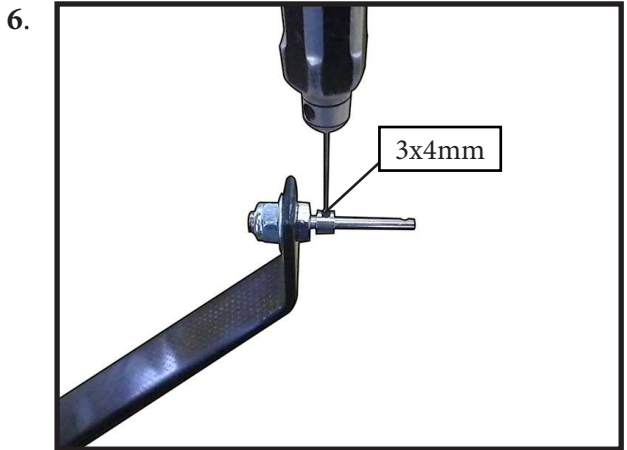
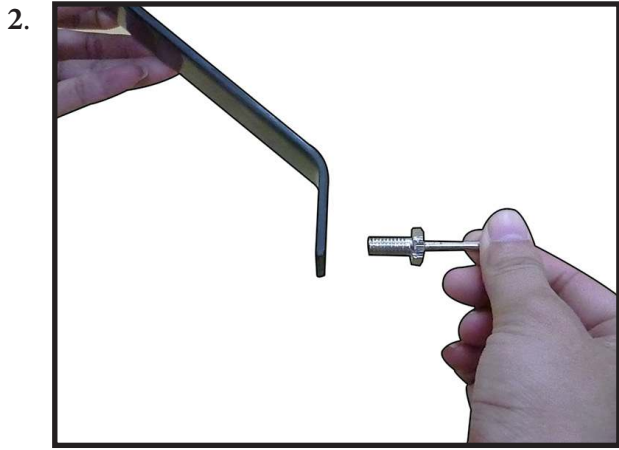

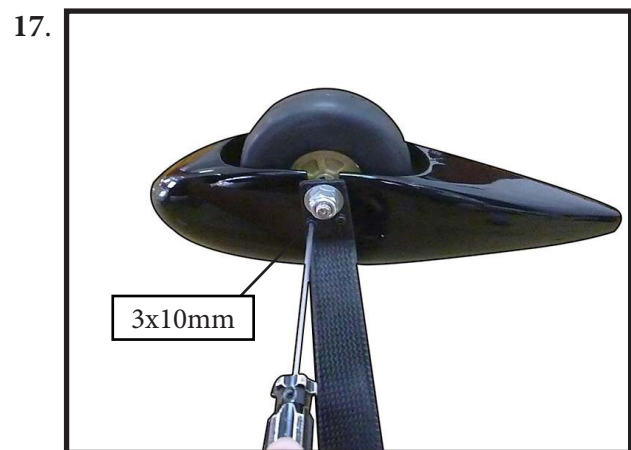
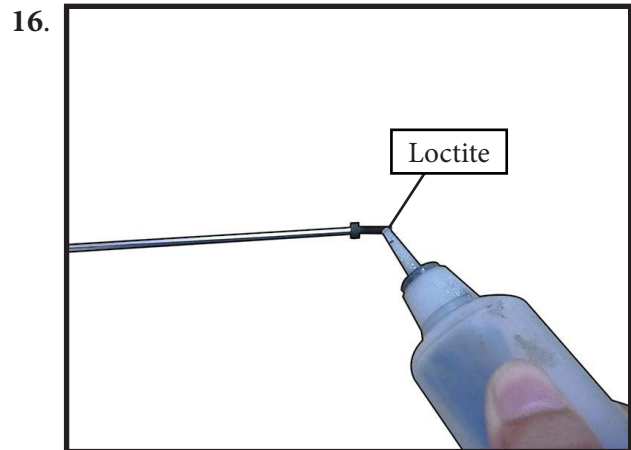
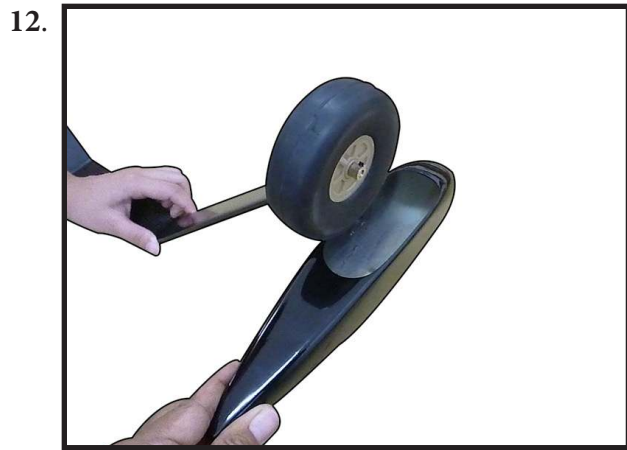
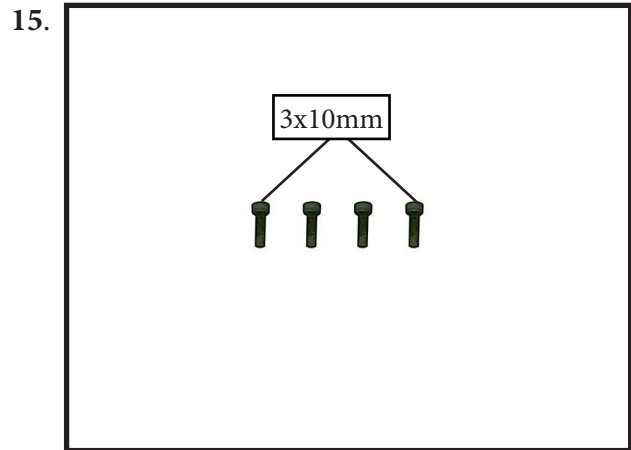
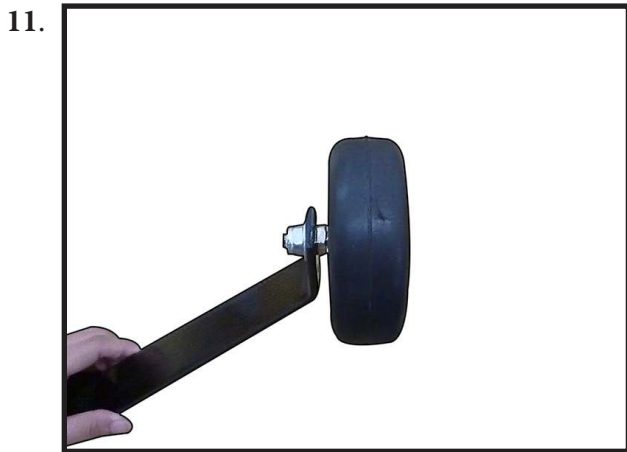
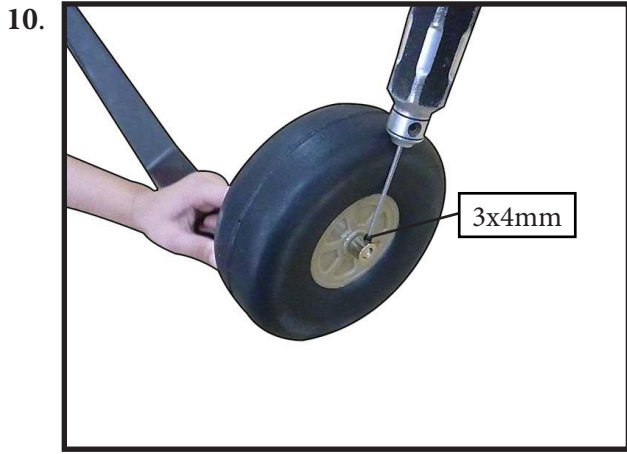

18.



22.

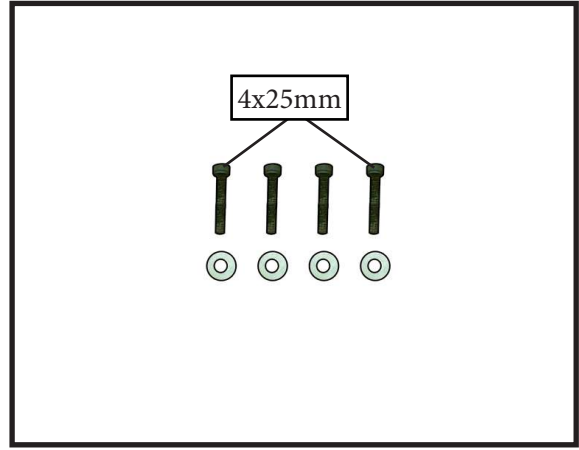

19.

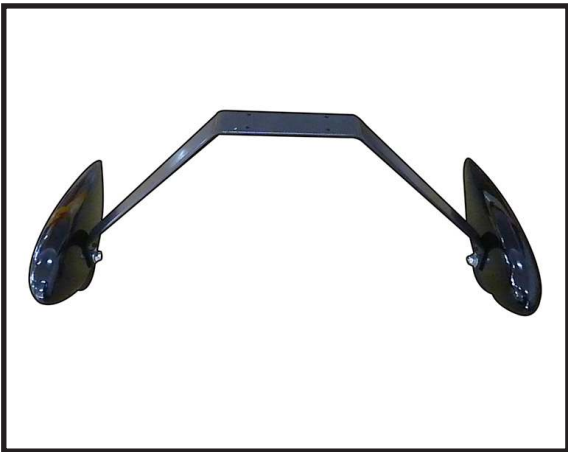

23.

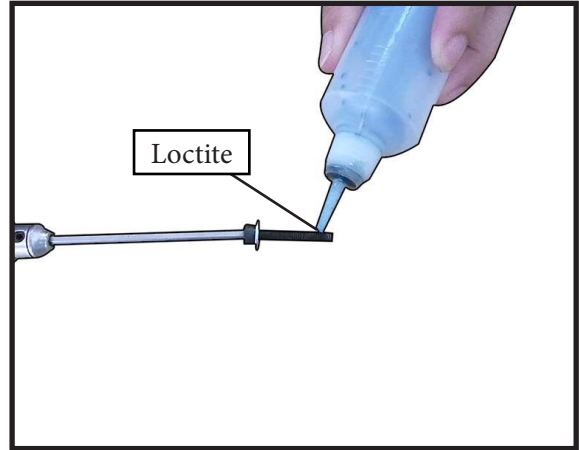

20.

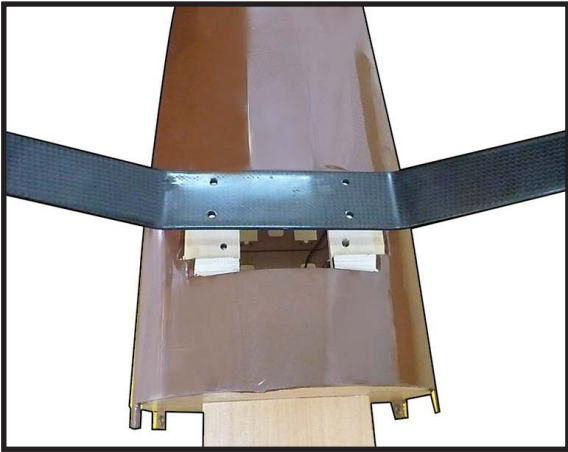

24.

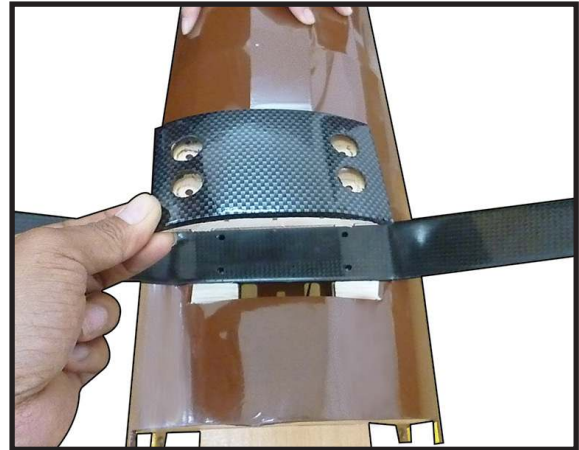

21.

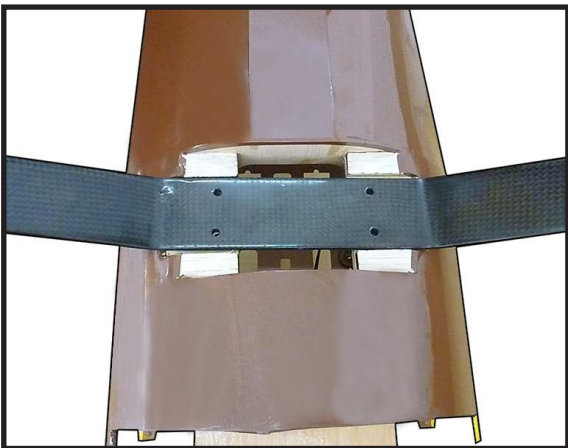

25.

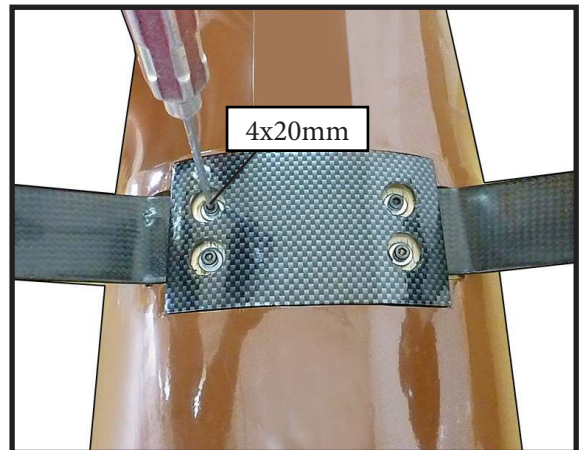

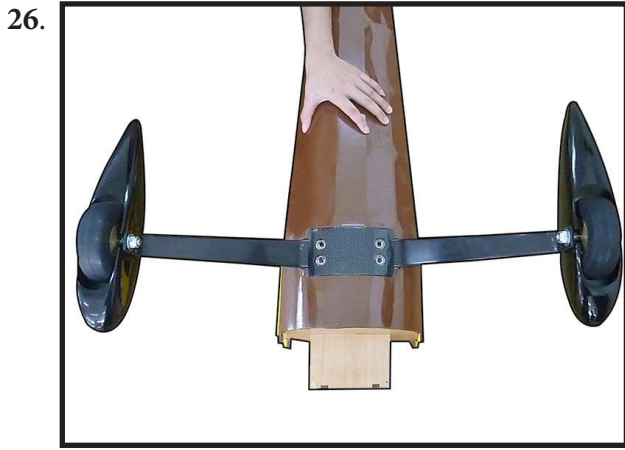

Install the switch into the precut hole in the side, in the fuselage.



INSTALLING THE RECEIVER SWITCH

Install the switch into the precut hole in the side, in the fuselage.

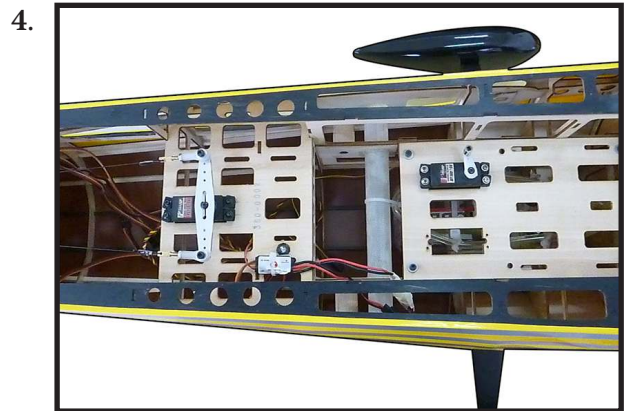
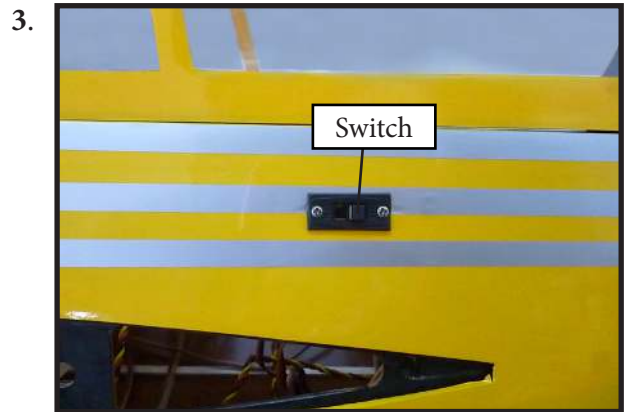
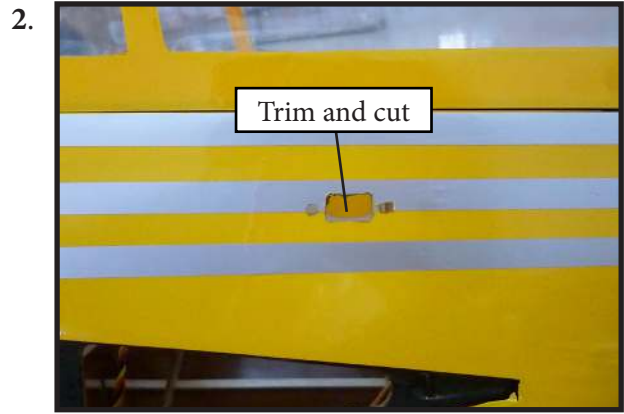
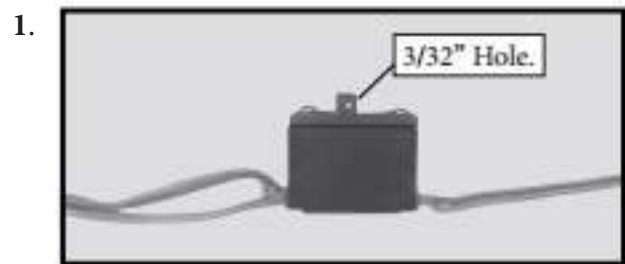

FUEL TANK ASSEMBLY

Please study images below.

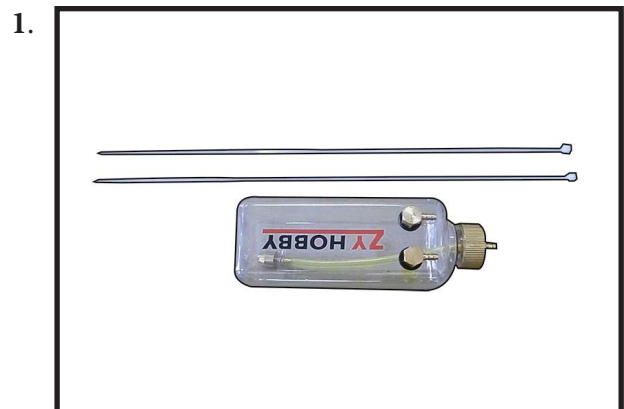

2.



6.

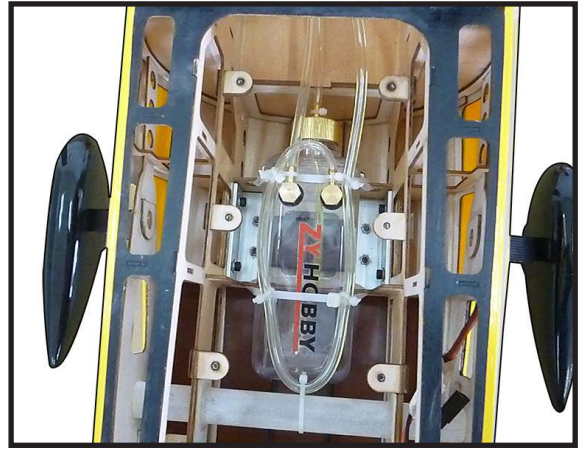

3.

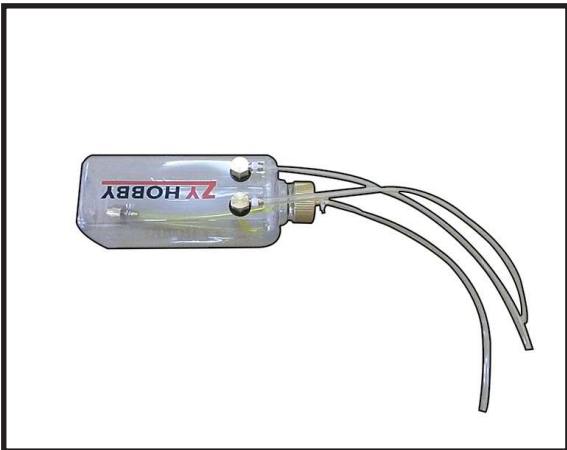

7.

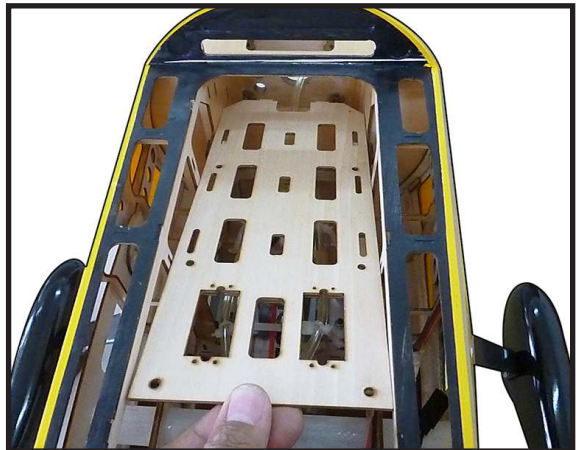

4.



8.



5.



9.

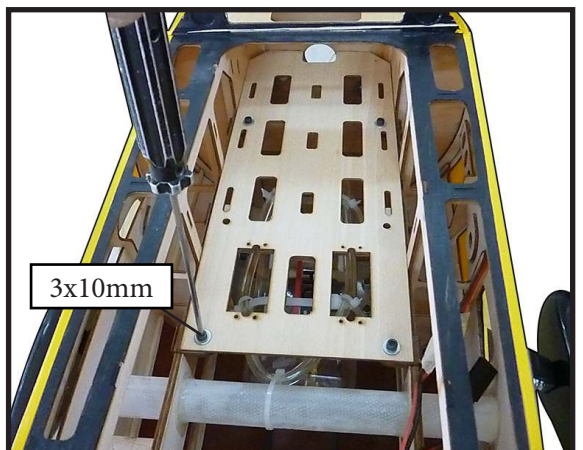

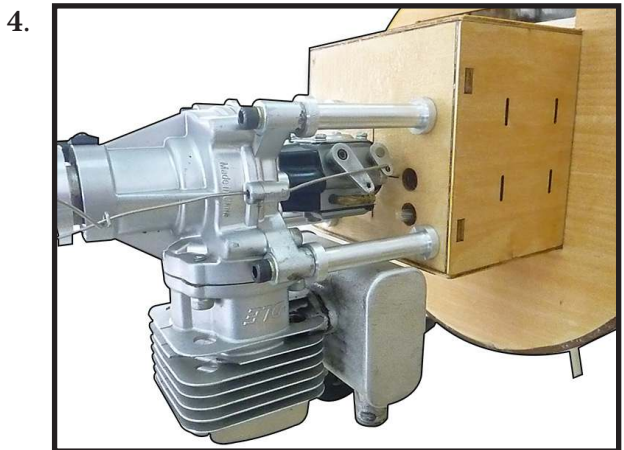
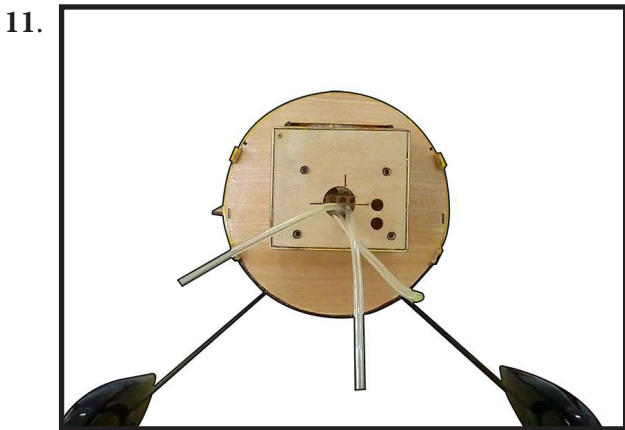
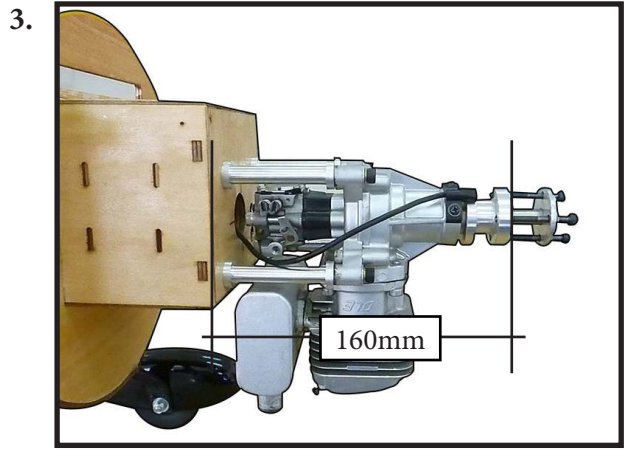
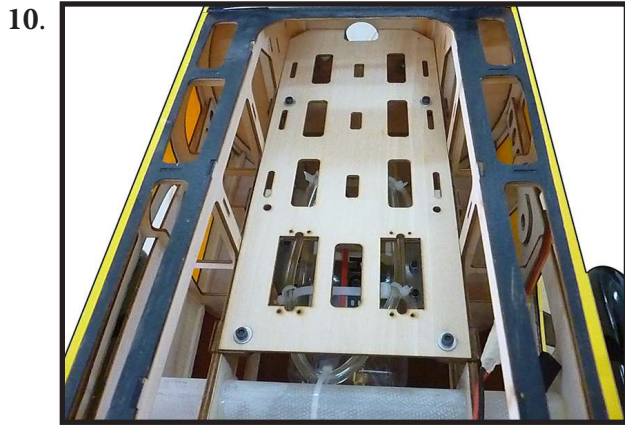

MOUNTING THE ENGINE

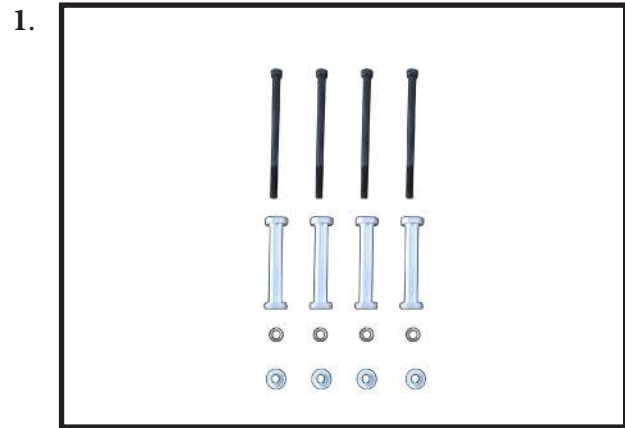

Attach throttle pushrod to the carburetor throttle arm with the ball link.

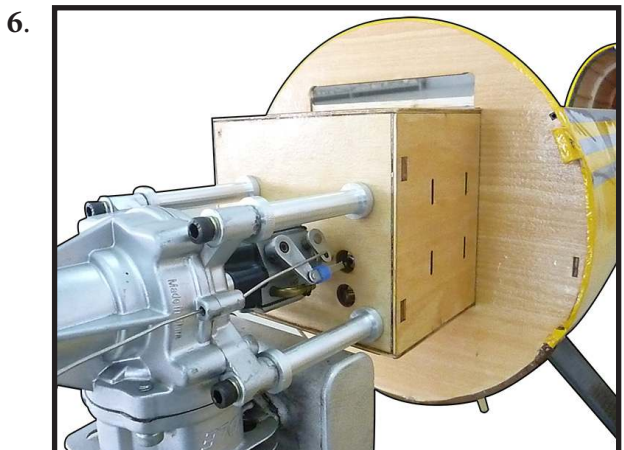
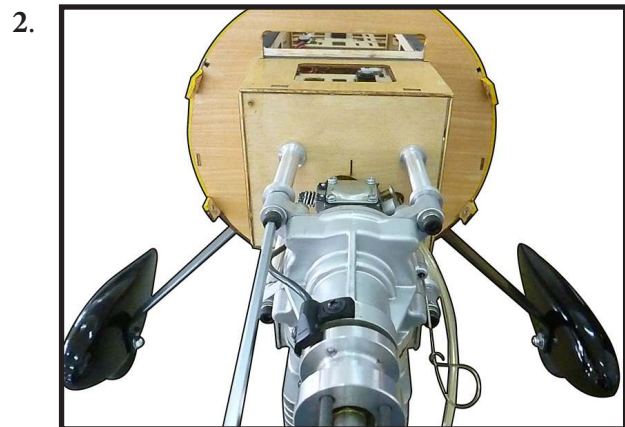

Install adjustable servo connector in the servo arm as same as picture below.

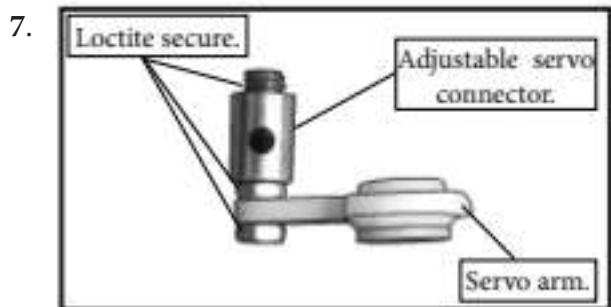

Reinstall the servo horn by sliding the connector over the pushrod wire. Center the throttle stick and trim and install the servo horn perpendicular to the servo center line.



Move the throttle stick to the closed position and move the carburetor to closed. Use a 2.5mm hex wrench to tighten the screw that secures the throttle pushrod wire. Make sure to use threadlock on the screw so it does not vibrate loose.



IGNITION INSTALLATION

I Thread nylon tie through mounting holes.

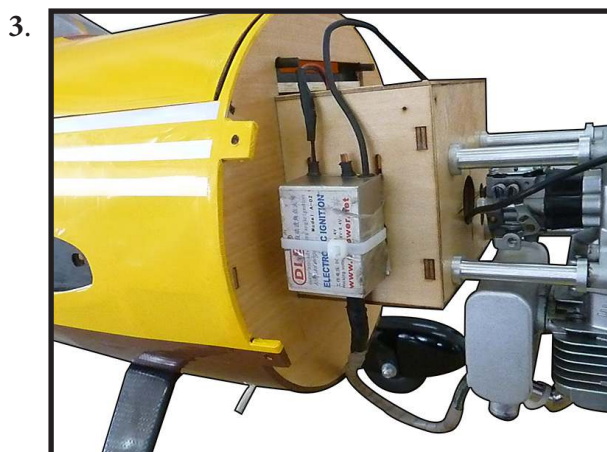

Connect ignition module to pickup line of engine. Secure with Safety Clip, safety wire, tape or other method. Ensure the plugs will not come apart from vibration or light tension.

Secure ignition wire with nylon ties as necessary.

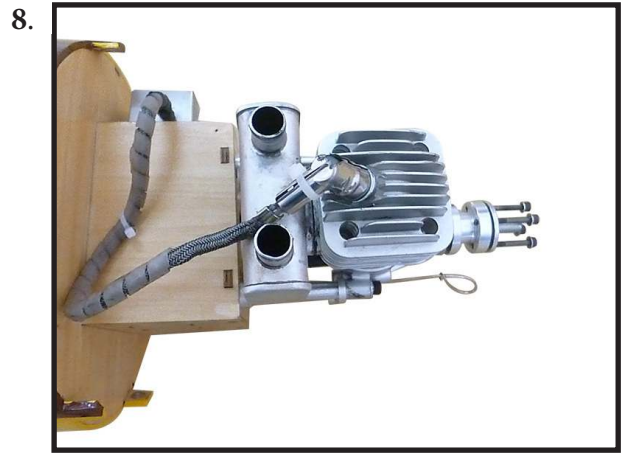
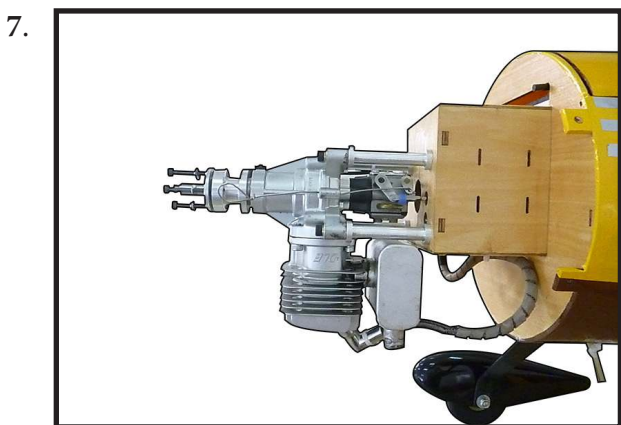
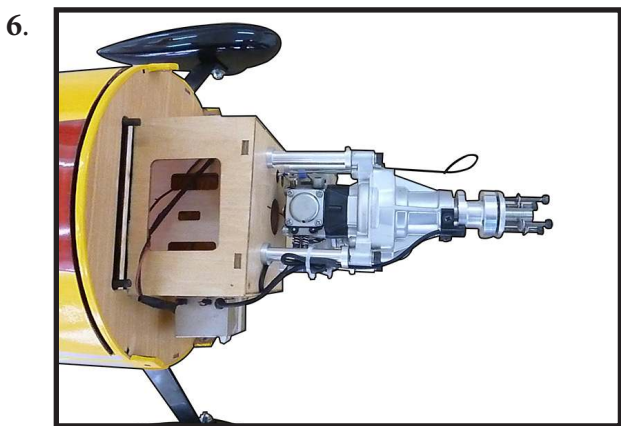
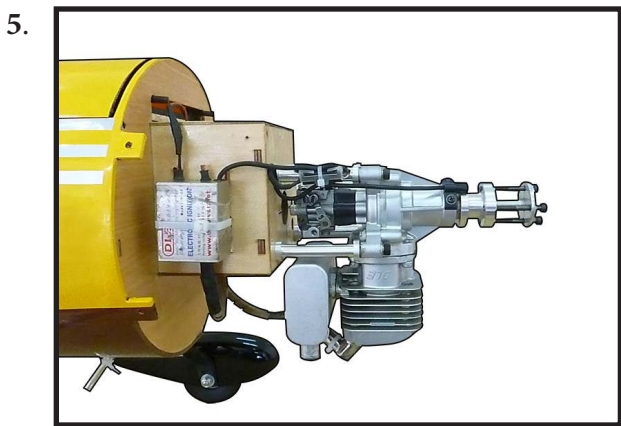
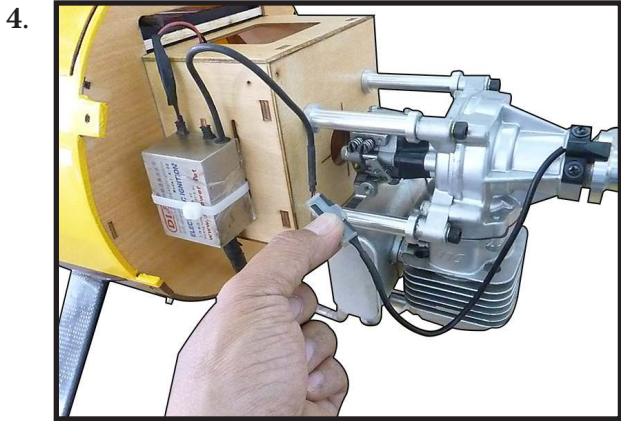

COWLING

Please study images below.





Tape the cowl to the fuselage using low-tack tape.

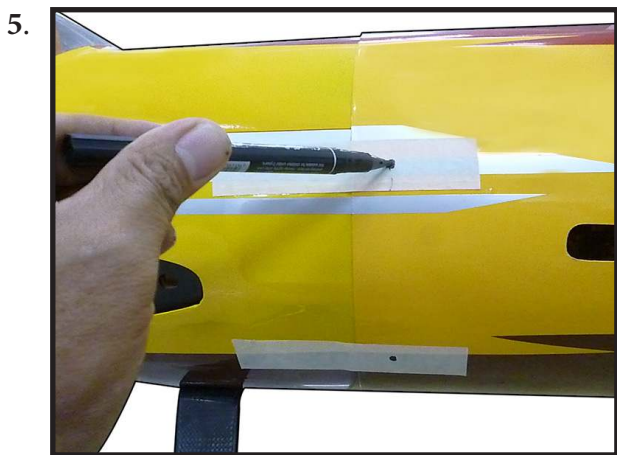
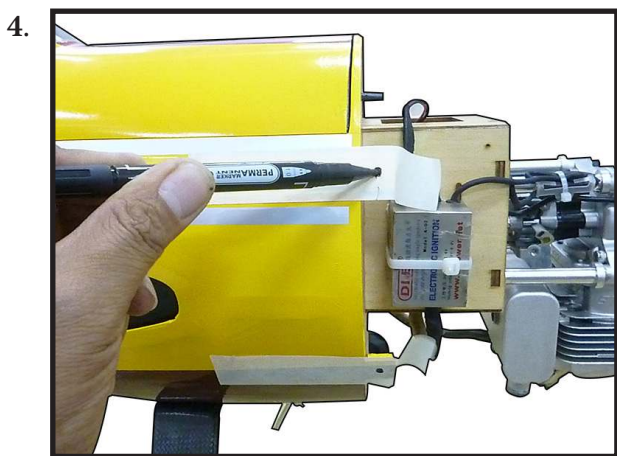

Use a drill and drill bit to drill the holes for the cowl mounting screws. Make sure the cowl position is correct before drilling each hole.

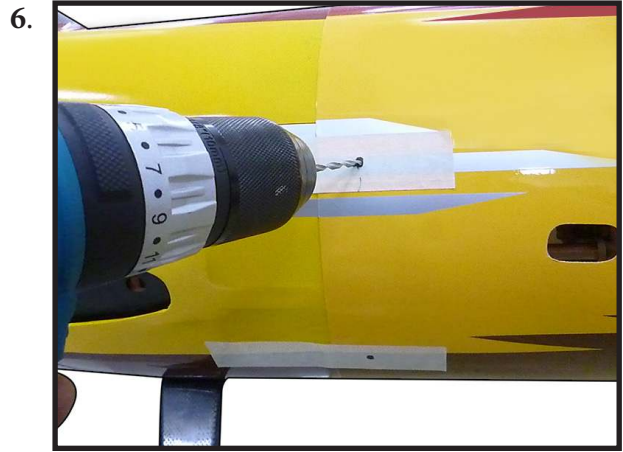

Install the muffler and muffler extension onto the engine and make the cutout in the cowl for muffler clearance. Connect the fuel and pressure lines to the carburetor, muffler and fuel filter valve. Secure the cowl to fuselage using the M3x10mm socket head screws. Putting a small length of silicon fuel tube under the head of the screw helps with vibration.

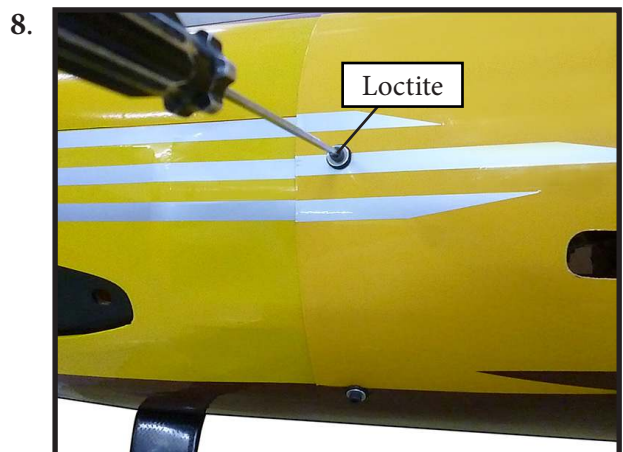
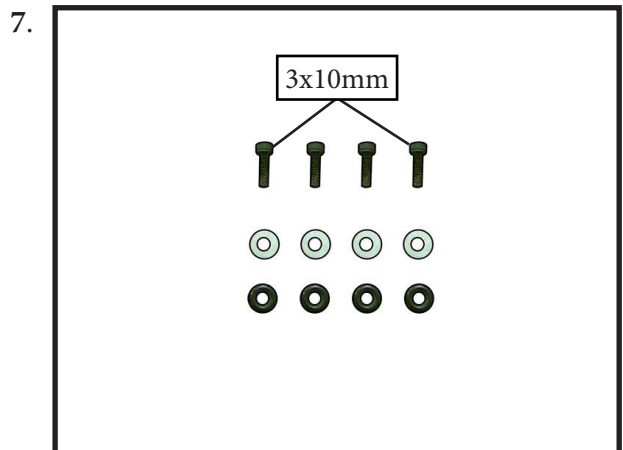

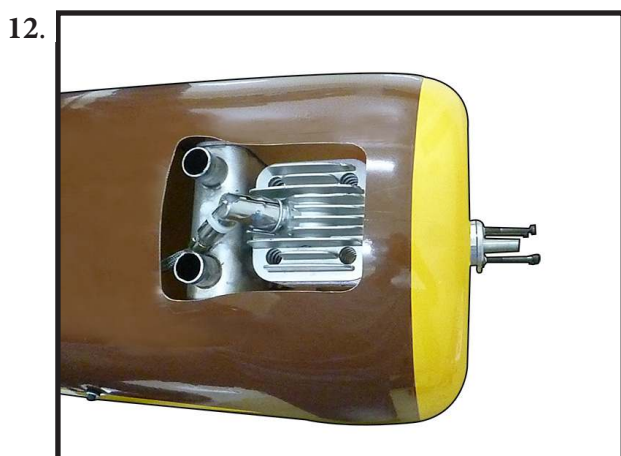

ELECTRIC POWER CONVERSION

Locate the items necessary to install the electric power conversion included with your model.

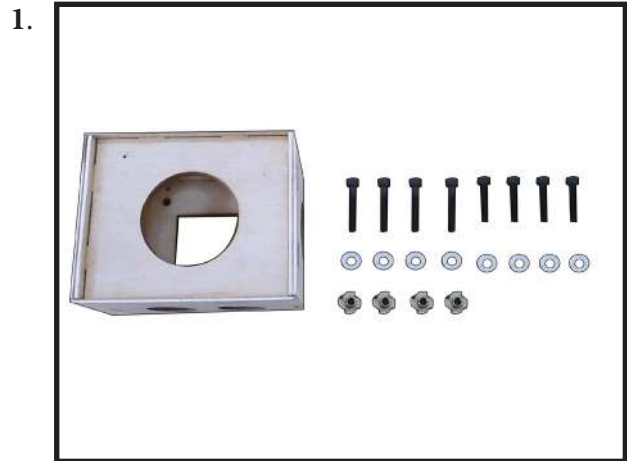

Recommend the items necessary to install the electric power conversion parts included with your model.

- Motor: 180/3000 - 3500 Watts

- Propeller: 20x8 ~ 21x10

- ESC: 80A - 120A

- 12S Lipo

Locate the engine mounting in position on the firewall. Use a 5mm drill bit to drill the holes necessary to mount your particular motor choice.

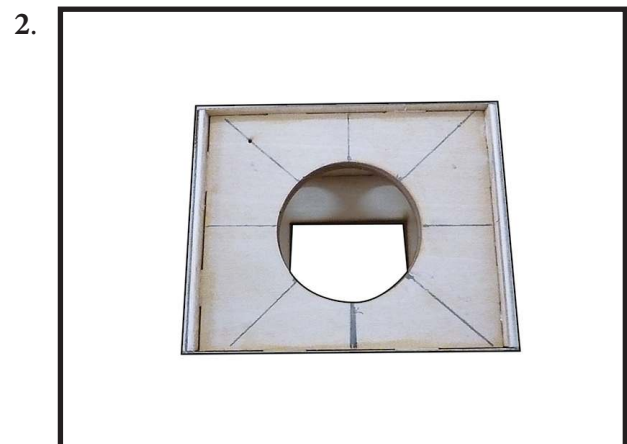

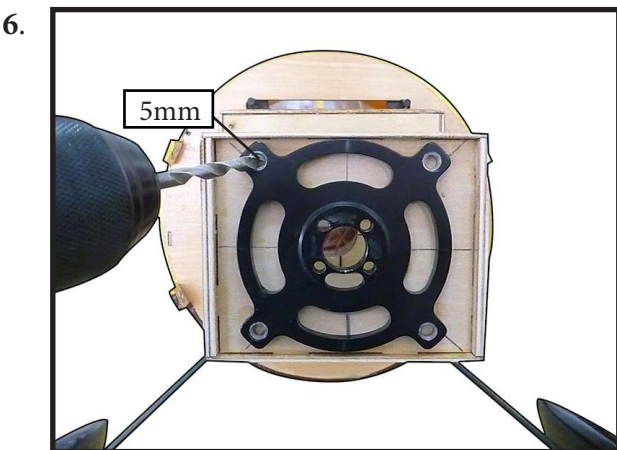
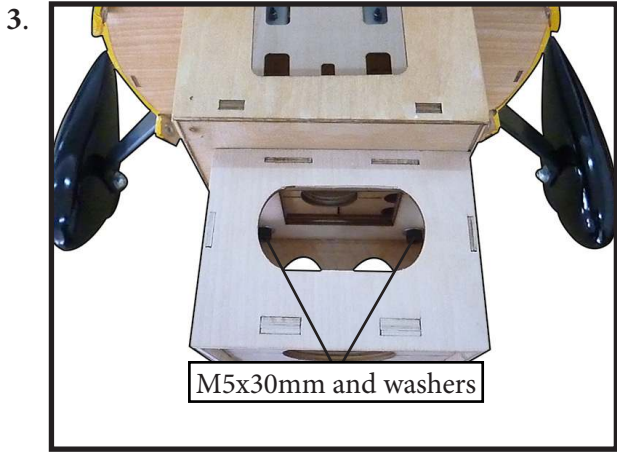

Then, use 5mm drill bit to enlarge the holes on the electric motor box.

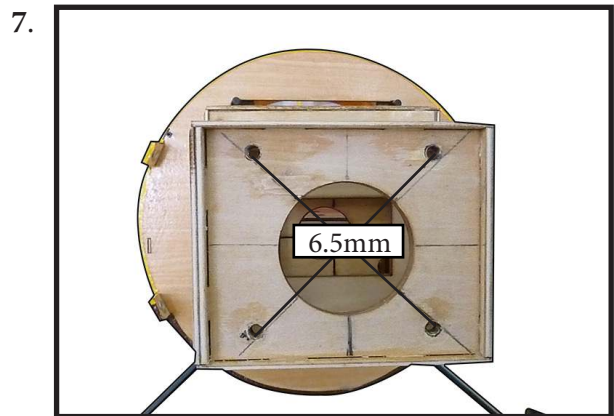

Attach the motor mount to the front of the electric motor box using four 6.5mm blind nut, four M5x25mm hex head bolts to secure the motor. Please see picture shown.

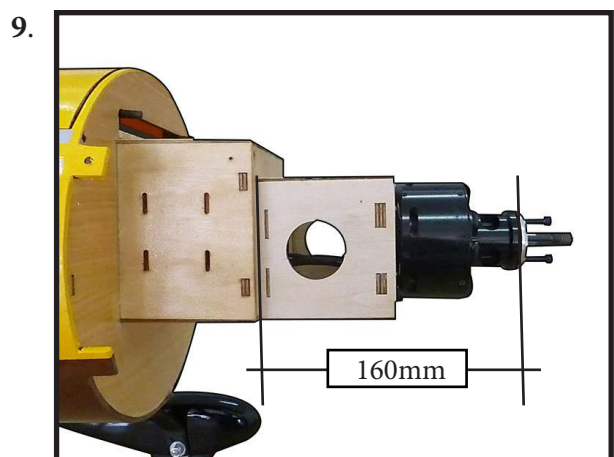
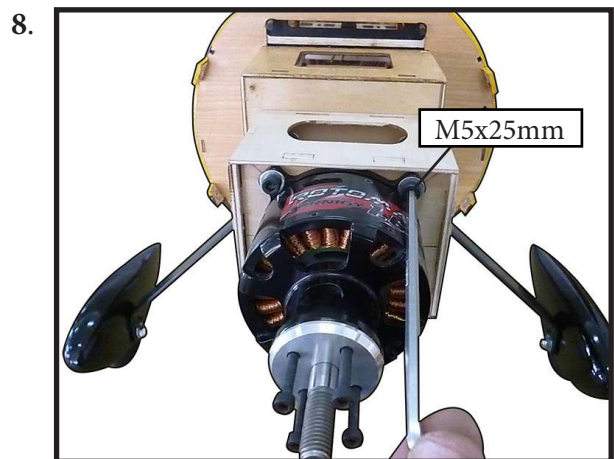

10.

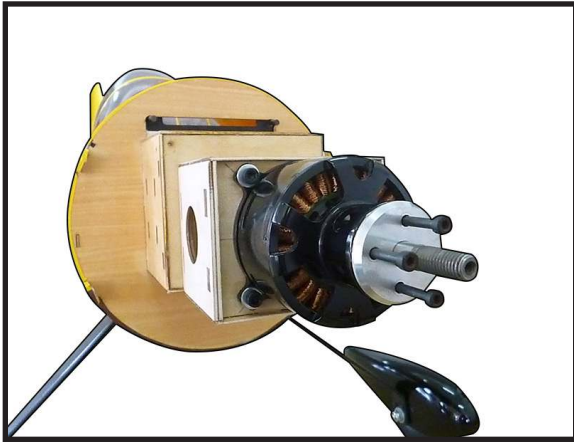

13.

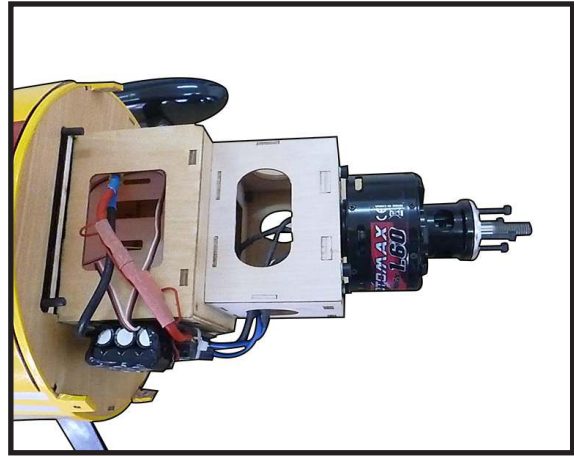

Attach the speed control to the side of the motor box using two-sided tape and tie wraps. Connect the appropriate leads from the speed control to the motor. Make sure the leads will not interfere with the operation of the motor.

14.

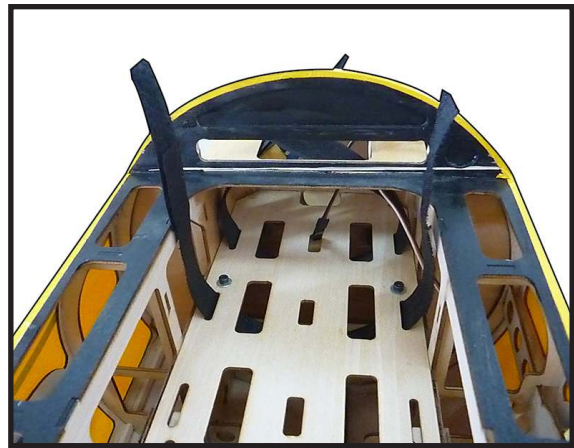

11.

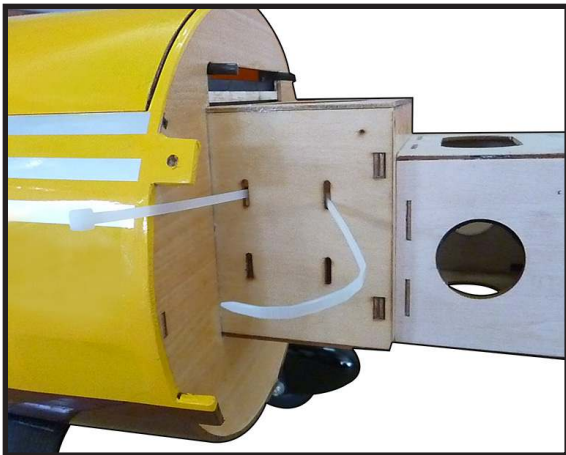

15.

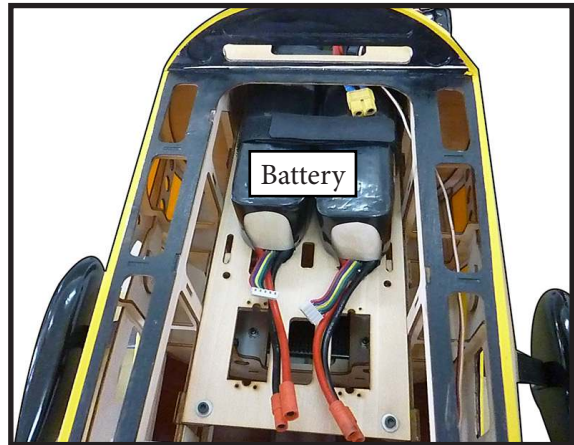

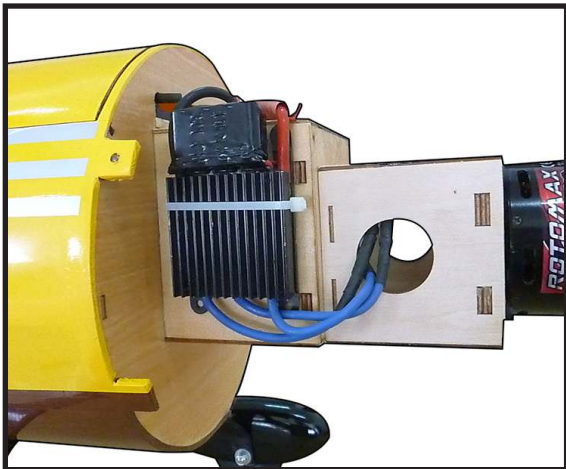

12.

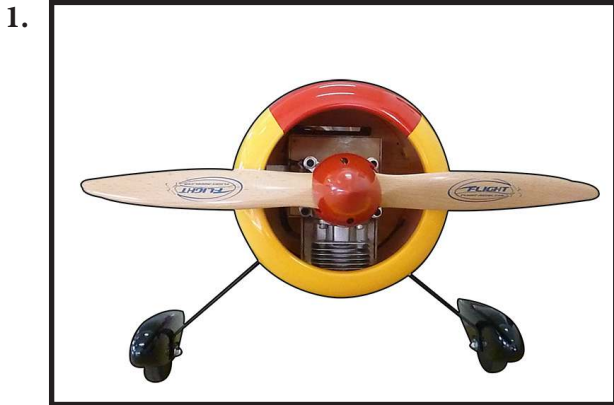

INSTALLING THE SPINNER

Install the spinner backplate, propeller and spinner cone.



 The propeller should not touch any part of the spinner cone. If it does, use a sharp modeling knife and carefully trim away the spinner cone where the propeller comes in contact with it.

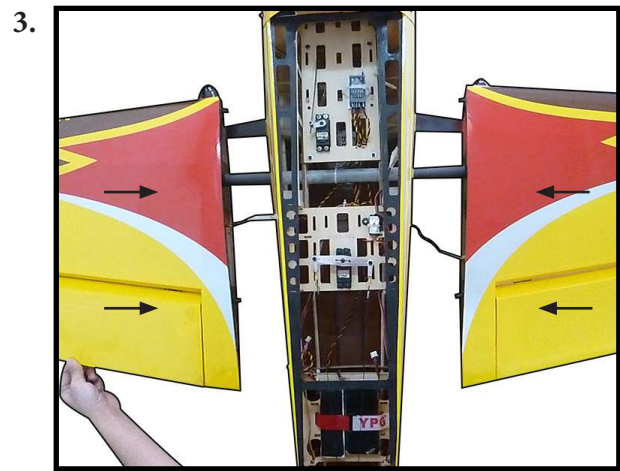
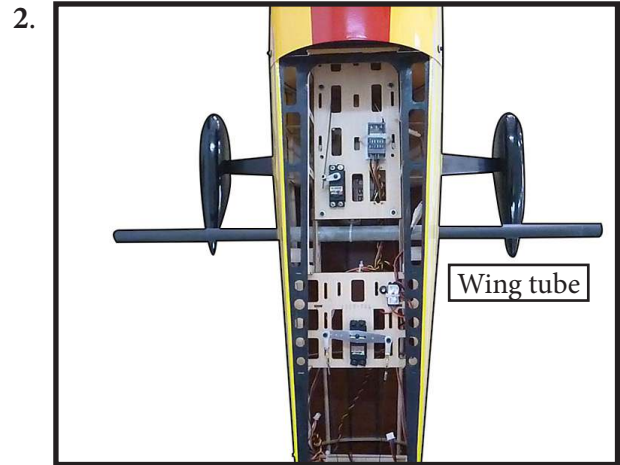

ATTACHMENT WING - FUSELAGE

Attach the aluminium tube into fuselage.

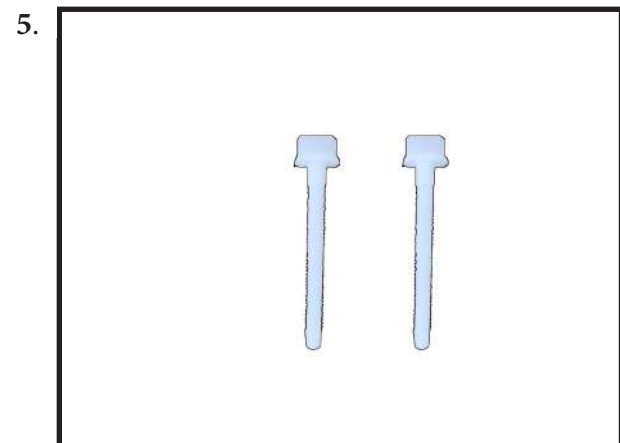



APPLY THE DECALS

If all the decals are pre-cut and ready to stick. Please be certain the model is clean and free from oily fingerprints and dust. Position decal on the model where desired, using the photos on the box and aid in their location.

If all the decals are not pre-cut, please use scissors or a sharp hobby knife to cut the decals from the sheet. Please be certain the model is clean and free from oily fingerprints and dust. Position decal on the model where desired, using the photos on the box and aid in their location.

BALANCING

An important part of preparing the aircraft for flight is properly balancing the model.

1) Attach the wing panels to the fuselage. Make sure to connect the leads from the aileron to the appropriate leads from the receiver. Make sure the leads are not exposed outside the fuselage before tightening the wing bolts. Your model should be flight-ready before balancing.

2) The recommended Center of Gravity (CG) location for your model is (168mm) back from the leading edge at the center of the wing.

3) When balancing your model, make sure it is assembled and ready for flight. Support the plane upright at the marks made on the wing with your fingers or a commercially available balancing stand. This is the correct balance point for your model.

*If possible, first attempt to balance the model by changing the position of the receiver battery and receiver. If you are unable to obtain good balance by doing so, then it will be necessary to add weight to the nose or tail to achieve the proper balance point.

With the wings attached to the fuselage, all parts of the model installed (ready to fly), and empty fuel tanks, hold the model at the marked balance point with the stabilizer level.

Lift the model. If the tail drops when you lift, the model is “tail heavy” and you must add weight* to the nose. If the nose drops, it is “nose heavy” and you must add weight* to the tail to balance.

1.

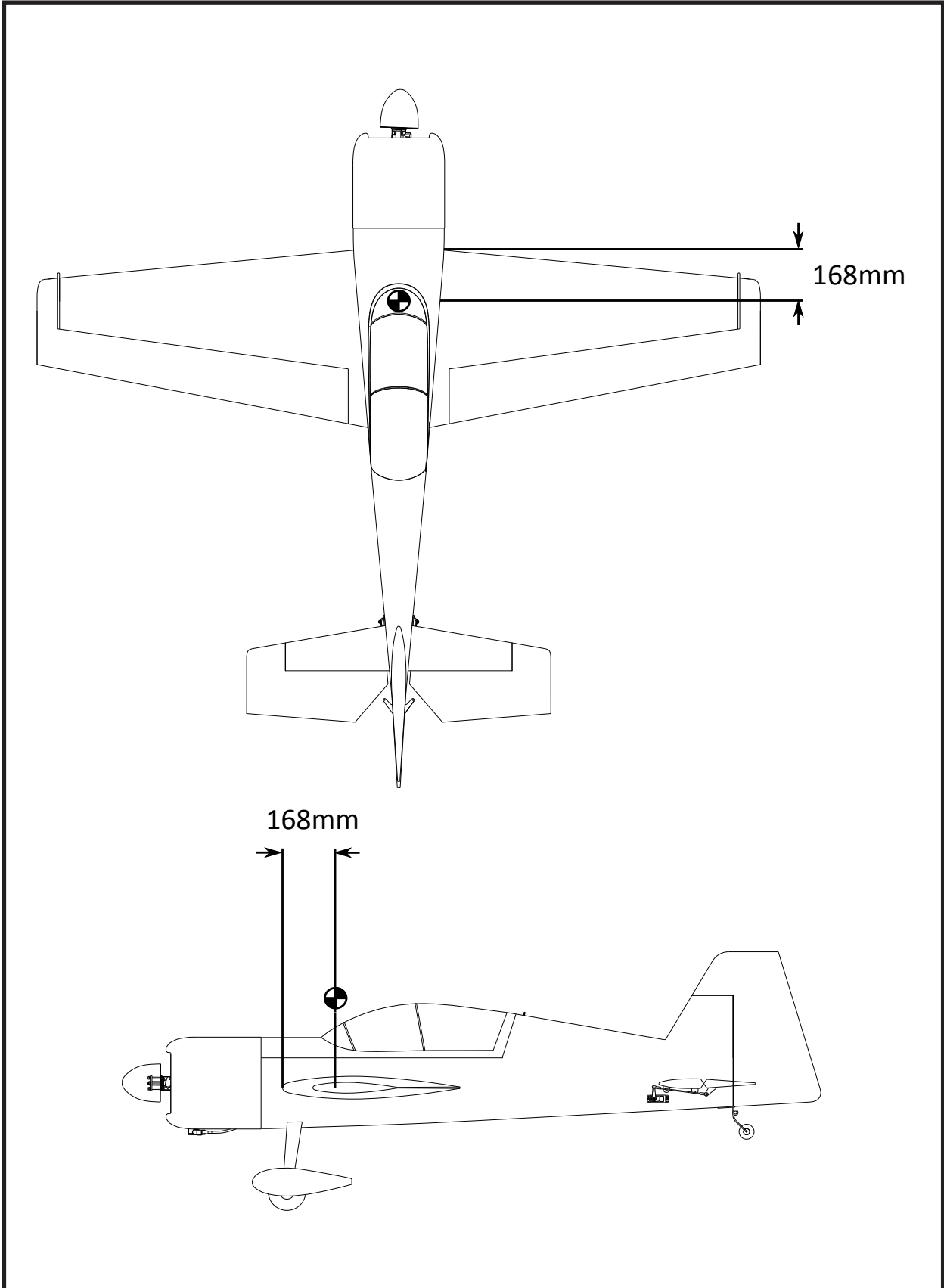

CONTROL THROWS

<p>Ailerons:</p> <p>High Rate : Up : 90 mm Down : 90 mm</p> <p>Low Rate : Up : 50 mm Down : 50 mm</p>	<p>Rudder:</p> <p>High Rate : Right : 100 mm Left : 100 mm</p> <p>Low Rate : Right : 60 mm Left : 60 mm</p>
<p>Elevator:</p> <p>High Rate : Up : 90 mm Down : 90 mm</p> <p>Low Rate : Up : 30 mm Down : 30 mm</p>	

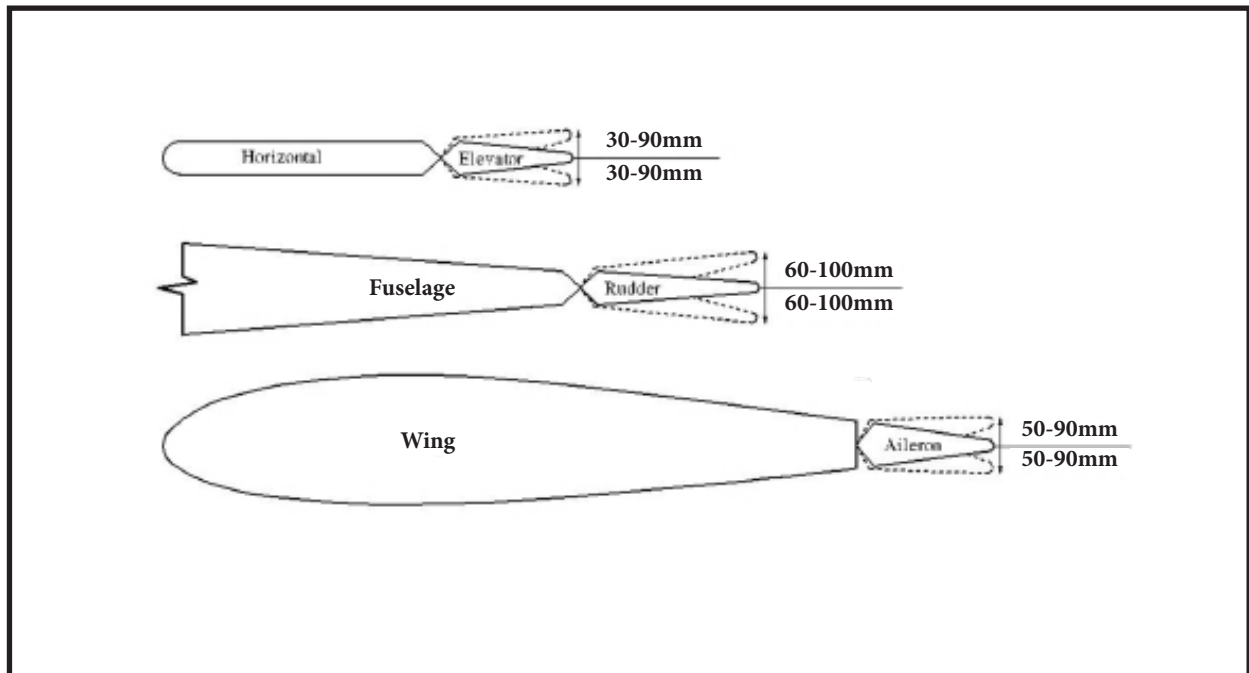

FLIGHT PREPARATION

Check the operation and direction of the elevator, rudder, ailerons and throttle.

A) Plug in your radio system per the manufacturer's instructions and turn everything on.

B) Check the elevator first. Pull back on the elevator stick. The elevator halves should move up. If they do not, flip the servo reversing switch on your transmitter to change the direction.

C) Check the rudder. Looking from behind the airplane, move the rudder stick to the right. The rudder should move to the right. If it does not, flip the servo reversing switch on your transmitter to change the direction.

D) Check the throttle. Moving the throttle stick forward should open the carburetor barrel. If it does not, flip the servo reversing switch on your transmitter to change the direction.

E) From behind the airplane, look at the aileron on the right wing half. Move the aileron stick to the right. The right aileron should move up and the other aileron should move down. If it does not, flip the servo reversing switch on your transmitter to change the direction.

PREFLIGHT CHECK

1) Completely charge your transmitter and receiver batteries before your first day of flying.

2) Check every bolt and every glue joint in the **YAK 54** to ensure that everything is tight and well bonded.

3) Double check the balance of the airplane. Do this with the fuel tank empty.

4) Check the control surfaces. All should move in the correct direction and not bind in any way.

5) If your radio transmitter is equipped with dual rate switches double check that they are on the low rate setting for your first few flights.

6) Check to ensure the control surfaces are moving the proper amount for both low and high rate settings.

7) Check the receiver antenna. It should be fully extended and not coiled up inside the fuselage.

8) Properly balance the propeller. An out of balance propeller will cause excessive vibration which could lead to engine and/or airframe failure.

*We wish you many safe and enjoyable flights
with your YAK 54.*

*If you have any queries, or are interested in our products,
please feel free to contact us*

Factory : 12/101A - Hamlet 4 - Le Van Khuong Street - Dong Thanh Ward -
Hoc Mon District - Ho Chi Minh City - Viet Nam.

Office : 62/8 Ngo Tat To Street - Ward 19 - Binh Thanh District - Ho Chi Minh
City - Viet Nam

Phone : 848 - 86622289 or 848- 36018777

Website : www.SeagullModels.com

Email : Sales@seagullmodels.com

Facebook : www.facebook.com/SeaGullModels.