

PARTS

★製品改良のためキットは予告なく仕様を変更することがあります。
 ★Specifications are subject to change without notice.
 ★Technische Daten können im Zuge ohne Ankündigung verändert werden.
 ★Caractéristiques pouvant être modifiées sans information préalable.

ボディ×1
 Body 11825048
 Karosserie
 Carrosserie

ウイング×1
 Wing 11835039
 Spoiler
 Aileron

アンダーガード×1
 Undertray 11825049
 Untere Schutzplatte
 Protection inférieure

A PARTS ×1
 19000526

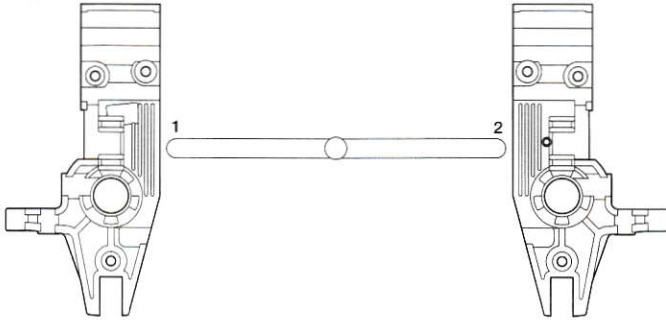

B PARTS ×1
 19000716

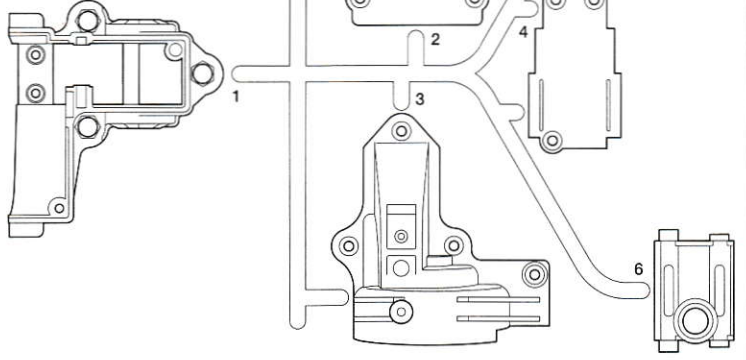

C PARTS ×1
 19000257

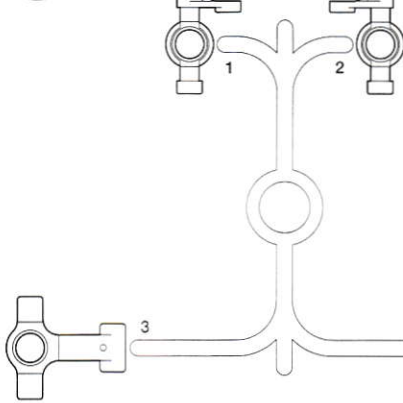

G PARTS ×1
 19005275

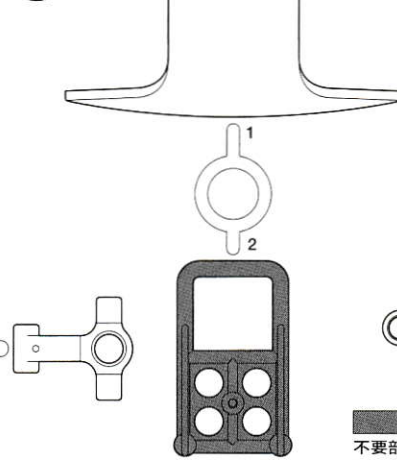

J PARTS ×1
 19115326

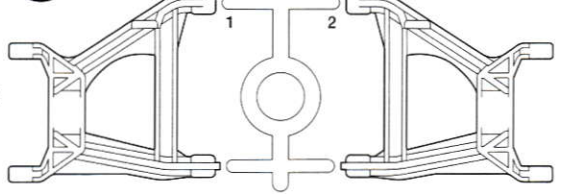

K PARTS ×1
 19115327

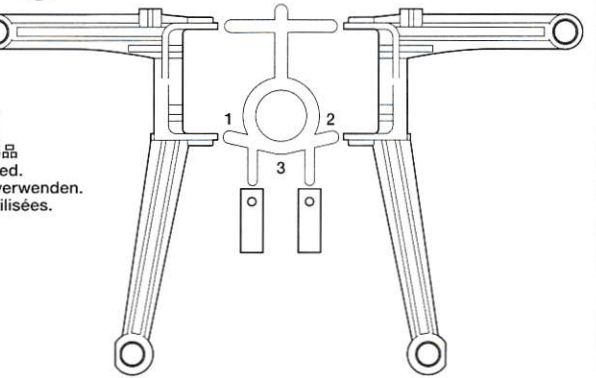

不要部品
 Not used.
 Nicht verwenden.
 Non utilisés.

N PARTS ×1
 19115329

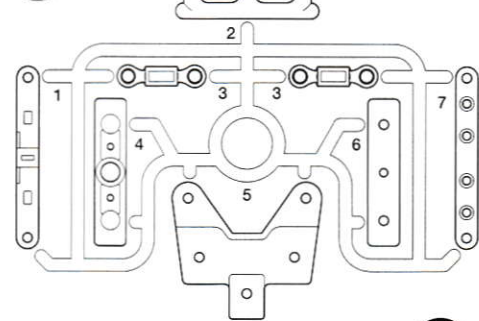

L PARTS ×1
 19115328

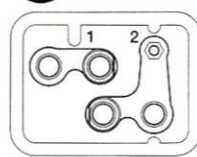

P PARTS ×1
 10115065

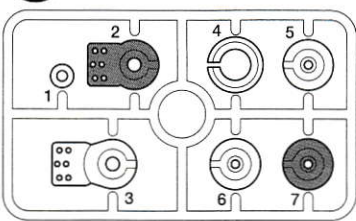

X PARTS ×2
 10225051

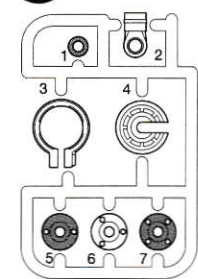

Y PARTS ×2
 10225052

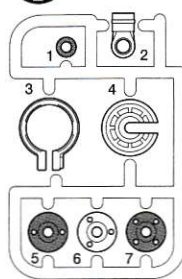

H PARTS ×1
 19005277

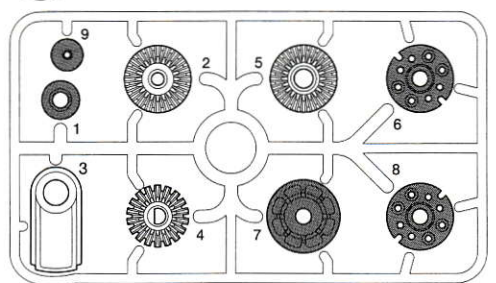

リヤホイール (太)×1
 Rear wheel (wide) 19335066
 Hinterrad (breit)
 Roue arrière (large)

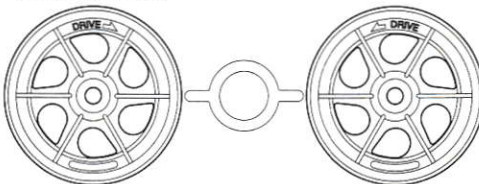

フロントホイール (細)×1
 Front wheel (narrow) 19335066
 Vorderrad (schmal)
 Roue avant (étroit)

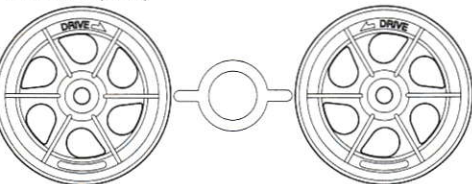

フロントタイヤ (細)×2
 Front tire 19804545
 Vorderer Reifen
 Pneu avant

アンテナパイプ×1
 Antenna pipe 16095010
 Antennenrohr
 Gaine d'antenne

リヤタイヤ (太)×2
 Rear tire 19805536
 Hinterer Reifen
 Pneu arrière

ステッカー a, b×1
 Stickers 19494255
 Autocollants

マスクシール×1
 Masking stickers 19494255
 Aufkleber
 Cache

注意ステッカー×1
 Caution stickers
 Vorsicht Sticker
 Stickers de precaution

PA
Blister pack A
Blister-Verpackung A
Emballage sous blister A

アッパーデッキ×1
 Upper deck 13405079
 Oberes Deck
 Platine supérieure

ロワデッキ×1
 Lower deck 13405078
 Chassisboden
 Platine inférieure

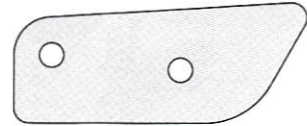

PA1 ×2
 13405080
サスマウント補強プレート
 Suspension arm reinforcing plate
 Verstärkungsplatte für Radaufhängung
 Plaque de renfort de bras de suspension



PA5 ×2
 19804652
リアコイルスプリング
 Rear coil spring
 Hintere Schraubenfeder
 Ressort hélicoïdal arrière

PA6 ×2
 19805322
フロントコイルスプリング
 Front coil spring
 Vordere Schraubenfeder
 Ressort hélicoïdal avant

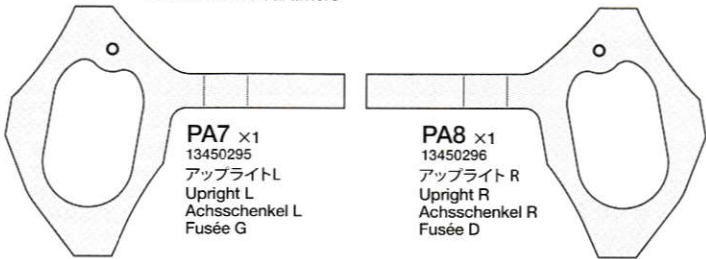

PA7 ×1
 13450295
アップライトL
 Upright L
 Achsschenkel L
 Fusée G

PA8 ×1
 13450296
アップライトR
 Upright R
 Achsschenkel R
 Fusée D

PG
ギヤ袋詰
Plastic gear bag
Plastik Zahnräder-Beutel
Sachet de pignonerie en plastique
 19335641



PG1 ×2
デフキャリア
 Differential spur gear
 Differentialrad
 Couronne de différentiel

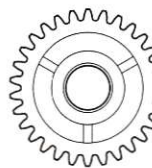

PG2 ×1
リアカウンターギヤ
 Rear counter gear
 Vorgelege-Rad hinten
 Pignon intermédiaire
 arrière



PG3 ×1
ロックスペーサー
 Locking spacer
 Verschluss-Distanzring
 Passage d'axe

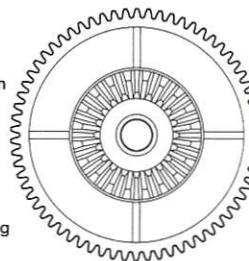

PG4 ×1
ドライブギヤ
 Drive gear
 Antriebsrad
 Pignon
 d'entraînement

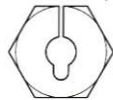

PA2 ×4
 53569
ホイールハブ
 Wheel hub
 Radnabe
 Moyeu de roue

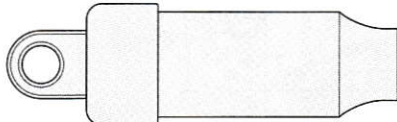

PA3 ×2
 19804651
リアダンパーシリンダー
 Rear damper cylinder
 Hinterer Dämpfer-Zylinder
 Corps d'amortisseur arrière

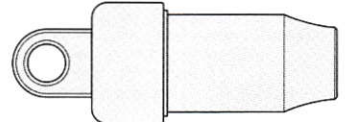

PA4 ×2
 19804649
フロントダンパーシリンダー
 Front damper cylinder
 Vordere Dämpfer-Zylinder
 Corps d'amortisseur avant

PC
ブッシュ袋詰
Metal parts bag
Metallteile-Beutel
Sachet des pièces métalliques

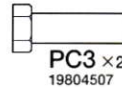

4×15mmパイブナット
 Pipe nut
 Rohr-Mutter
 Tube-écrou
PC3 ×2
 19804507



5×6mm六角ブッシュ
 Hexagonal bushing
 Seckskanthülse
 Entroise
 hexagonale
PC4 ×2
 19804510



5×6mm丸ブッシュ
 Round bushing
 Kreishülse
 Entroise
PC5 ×4
 19804509

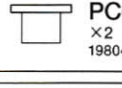

5×4mm丸ブッシュ
 Round bushing
 Kreishülse
 Entroise
PC6 ×2
 19804773

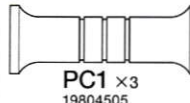

シャーシステー
 Chassis stay
 Chassis-Strebe
 Support de
 châssis
PC1 ×3
 19804505

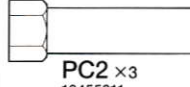

6×25mm
 パイブナット
 Pipe nut
 Rohr-Mutter
 Tube-écrou
PC2 ×3
 13455211

PB
Blister pack B
Blister-Verpackung B
Emballage sous blister B

ギヤボックスプレート×1
 Gearbox plate 14305227
 Getriebedeckel
 Plaque de réducteur

プロペラシャフト×1
 Propeller shaft 13485025
 Antriebswelle
 Arbre de transmission



PB1 ×4
 19804858
1680ベアリング
 Ball bearing
 Kugellager
 Roulement à billes



PB2 ×2
 19804470
デフスクルー
 Diff screw
 Diff.-Schraube
 Vis de diff.



PB3 ×2
 19804502
デフナット
 Diff nut
 Diff.-Mutter
 Ecrou de diff.



PB4 ×2
 49299
デフスプリング
 Diff spring
 Differentialfeder
 Ressort de diff



PB5 ×4
 19401761
ホイールアクスル
 Wheel axle
 Rad-Achse
 Axe de roue



PB6 ×4
 19803284
スイングシャフト
 Swing shaft
 Drehachse
 Axe de basculement



PB7 ×1
 12595062
リアプロペラジョイント
 Rear propeller joint
 Hinteres Antriebs-Gelenk
 Accouplement d'arbre de
 transmission arrière



PB8 ×1
 12595063
フロントプロペラジョイント
 Front propeller joint
 Vordere Antriebs-Gelenk
 Accouplement d'arbre de
 transmission avant



PB9 ×1
 12595197
**トルクスプリッターリアプロペラ
 ジョイント**
 Rear propeller joint (torque splitter)
 Hinteres Antriebs-Gelenk für Freilauf
 Accouplement d'arbre de transmission
 arrière (répartiteur de couple)



PB10 ×1
 15700022
ワンウェイベアリング
 One-way bearing
 Einweg-Lager
 Roulement à aiguilles
 à sens unique

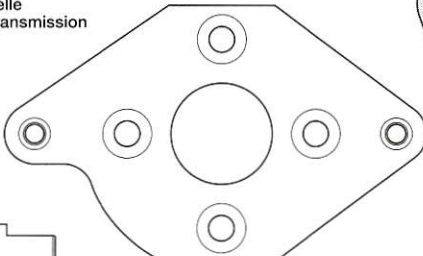

PB11 ×1
 14305243
モーターマウント
 Motor mount
 Motor-Lager
 Support-moteur

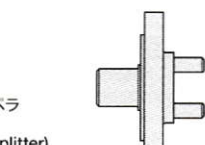

PB12 ×2 13450321
デフィンナーL
 Diff inner L
 Differentialplatte L
 Intérieur gauche diff.

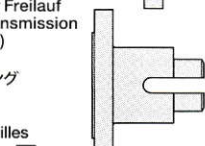

PB13 ×1 13450323
リアデフィンナーR
 Rear diff inner R
 Differentialplatte hinten R
 Intérieur droit diff. arrière

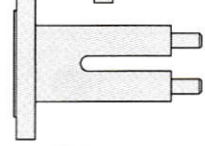

PB14 ×1 13450322
フロントデフィンナーR
 Front diff inner R
 Differentialplatte vorder R
 Intérieur droit diff. avant

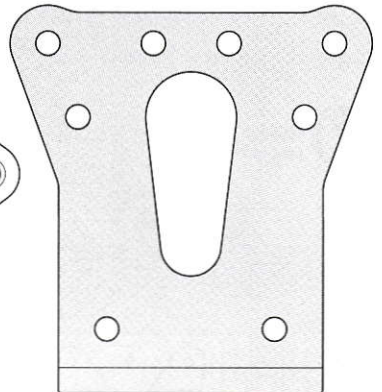

PB15 ×1
 13405081
リアダンパーステー
 Rear damper stay
 Hintere Dämpferstrebe
 Support d'amortisseurs
 arrière

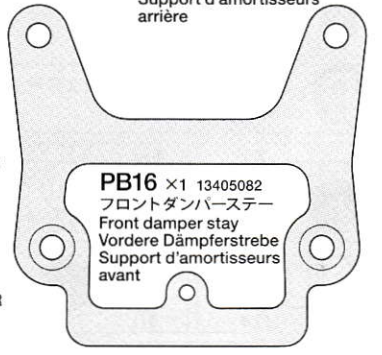

PB16 ×1 13405082
フロントダンパーステー
 Front damper stay
 Vordere Dämpferstrebe
 Support d'amortisseurs
 avant

A ①~⑪



3×10mm丸ビス
 Screw
 Schraube
 Vis
BA1 ×2
 19804159



3×10mmフラットビス
 Screw
 Schraube
 Vis
BA2 ×1
 19804418



3×8mmビス
 Screw
 Schraube
 Vis
BA3 ×6
 19805696



3×6mmビス
 Screw
 Schraube
 Vis
BA4 ×2
 19804286



3×8mmタッピングビス
 Tapping screw
 Schneidschraube
 Vis taraudeuse
BA5 ×2
 19805754



3×10mmタッピングビス
 Tapping screw
 Schneidschraube
 Vis taraudeuse
BA6 ×16
 50578



3×3mmイモネジ
 Grub screw
 Madenschraube
 Vis pointeau
BA7 ×1
 50576



3mmワッシャー
 Washer
 Beilagscheibe
 Rondelle
BA8 ×1
 50586



3mmEリング
 E-Ring
 Circlip
BA9 ×2
 50380

A

スポンジテープ (15×150mm) …×1
Sponge tape 16294011
Schaumgummi-Klebeband
Bande mousse

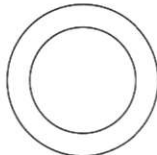

BA10 ×4
19804843
14mmワッシャー
Washer
Beilagscheibe
Rondelle



BA11 ×4
51417
スラストプレート
Thrust washer
Druckscheibe
Rondelle de butée



BA12 ×1
53008
1150ベアリング
Ball bearing
Kugellager
Roulement à billes



BA13 ×7
94392
850ベアリング
Ball bearing
Kugellager
Roulement à billes



BA14 ×2
94389
620ベアリング
Ball bearing
Kugellager
Roulement à billes

BA15 ×18
15700147
3/32インチスチールボール
Steel ball (3/32 inch)
Stahlkugel (3/32 inch)
Bille en acier (2,4mm)

BA16 ×16
51417
1/16インチスチールボール
Steel ball (1/16 inch)
Stahlkugel (1/16 inch)
Bille en acier (1,6mm)

BA17 ×1
13485024
5×24mmシャフト
Shaft
Achse
Axe

BA18 ×1
13482002
2×36mmシャフト
Shaft
Achse
Axe

BA19 ×2
19804501
リヤデフジョイント
Rear diff joint
Hinterer Differentialabtrieb
Noix de cardan arrière

BA20 ×2
19804500
フロントデフジョイント
Front diff joint
Vorderer Differentialabtrieb
Noix de cardan avant

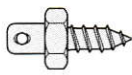

BA21 ×2
19805732
六角マウント
Hexagonal mount
Sechskantbefestigung
Support hexagonal

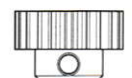

BA22 ×1
50357
22Tピニオンギヤ
22T Pinion gear
22Z Motorritzel
Pignon moteur 22 dents



ボールデフグリス ……×1
Ball Diff Grease 53042
Fett für Kugeldifferential
Graisse pour différentiel à billes



セラミックグリス ……×1
Ceramic grease 87099
Keramikfett
Graisse céramique

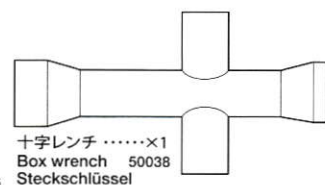

六角棒レンチ (1.5mm) …×1 50038
Hex wrench (1.5mm)
Imbusschlüssel (1,5mm)
Clé Allen (1,5mm)



アンチウェアグリス ……×1
Anti-wear grease 53439
Verschleiß mindernes Fett
Graisse anti-usure

B 12~21



BB1 ×2
19805895
3×20mm丸ビス
Screw
Schraube
Vis



BA1 ×5
19804159
3×10mm丸ビス
Screw
Schraube
Vis



BB2 ×4
50579
3×10mm段付ビス
Step screw
Paßschraube
Vis décollétée



BB3 ×2
19804417
3×18mmフラットビス
Screw
Schraube
Vis



BB4 ×2
19804775
3×42mm皿ビス
Screw
Schraube
Vis



BB5 ×2
19805745
3×25mm皿ビス
Screw
Schraube
Vis

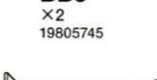

BB6 ×3
19804201
3×18mm皿ビス
Screw
Schraube
Vis



BB7 ×2
19805977
3×12mm皿ビス
Screw
Schraube
Vis



BA3 ×3
19805696
3×8mm皿ビス
Screw
Schraube
Vis



BB8 ×1
50581
3×12mm皿タッピングビス
Tapping screw
Schneidschraube
Vis taraudeuse

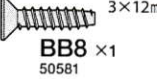

BA6 ×4
50578
3×10mm皿タッピングビス
Tapping screw
Schneidschraube
Vis taraudeuse



BB9 ×2
19805893
1.6×4mmキャップスクリュー
Cap screw
Zylinderkopfschraube
Vis à tête cylindrique

BA7 ×2
50576
3×3mmイモネジ
Grub screw
Madenschraube
Vis pointeau

BB10 ×2
19805777
3×2.5mmイモネジ
Grub screw
Madenschraube
Vis pointeau

BB11 ×4
19803266
3mmロックナット
Lock nut
Sicherungsmutter
Ecrou nylonstop

BB12 ×4
19805897
3mmフランジナット
Flange nut
Kragenmutter
Ecrou à flasque

BA8 ×2
50586
3mmワッシャー
Washer
Beilagscheibe
Rondelle

BB13 ×4
19805626
8mmボール
Ball
Kugel
Bille

BB14 ×2
19805611
5×9mmビローボール
Ball connector
Kugelkopf
Connecteur à rotule

BB15 ×4
19804345
6mmビローボールナット
Ball connector nut
Kugelkopf-Mutter
Ecrou-connecteur à rotule

BB16 ×2
19804206
5mmビローボールナット
Ball connector nut
Kugelkopf-Mutter
Ecrou-connecteur à rotule

BB17 ×1
50380
4mmEリング
E-Ring
Circlip

BA12 ×5
53008
1150ベアリング
Ball bearing
Kugellager
Roulement à billes

BA13 ×1
94392
850ベアリング
Ball bearing
Kugellager
Roulement à billes

BB18 ×2
94386
830ベアリング
Ball bearing
Kugellager
Roulement à billes

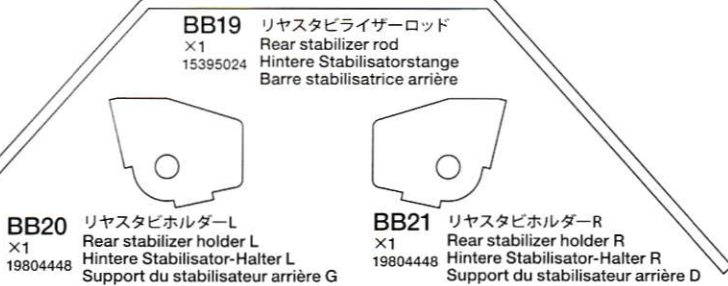

BB19 ×1
15395024
リヤスタビライザーロッド
Rear stabilizer rod
Hintere Stabilisatorstange
Barre stabilisatrice arrière

BB20 ×1
19804448
リヤスタビホルダーL
Rear stabilizer holder L
Hintere Stabilisator-Halter L
Support du stabilisateur arrière G

BB21 ×1
19804448
リヤスタビホルダーR
Rear stabilizer holder R
Hintere Stabilisator-Halter R
Support du stabilisateur arrière D

BB22 ×2
19400797
3×42mmターンバックルシャフト
Turnbuckle shaft
Spann-Achse
Biellette à pas inversés

BB23 ×2
50594
2×10mmシャフト
Shaft
Achse
Axe

BB24 ×2
19440664
1.6×10.4mmシャフト
Shaft
Achse
Axe

BB25 ×1
13580033
3×22mmパイプ
Pipe
Rohr
Tube

BB26 ×1
13455745
5×5.2mmスペーサー
Spacer
Distanzring
Entretoise

BB27 ×2
19804246
5×0.5mmスペーサー
Spacer
Distanzring
Entretoise

BB28 ×2
53539
3×2.5mmスペーサー
Spacer
Distanzring
Entretoise

BB29 ×1
84195
3mmOリング (黒)
O-ring (black)
O-Ring (schwarz)
Joint torique (noir)

BB30 ×2
19805358
リヤアームマウント
Rear arm mount
Befestigung hinterer Lenker
Support de triangle arrière

BB31 ×2
19804774
テーパーブッシュ (長)
Tapered bushing (long)
Kegel-Hülse (lang)
Entretoise (longue)

BB32 ×1
13455243
アンダーガードマウント
Undertray mount
Halterung für untere
Schutzplatte
Support de protection
inférieure

BB33 ×2
13455130
スタビライザーエンド
Stabilizer ball
Stabilisator-
Kugelkopflager
Rotule de barre
anti-roulis

BA21 ×1
19805732
六角マウント
Hexagonal mount
Sechskantbefestigung
Support hexagonal

BB34 ×2
19804552
ブッシュベース
Bushing base
Hülsenbasis
Entretoise

BB35 ×2
19440664
クロススパイダー
Cross joint
Kreuzzapfen
Joint en croix

BB36 ×4
50953
6mmアジャスター
Adjuster
Einstellstück
Chape à rotule

BB37 ×2
19805922
デフスポンジ
Diff sponge
Abstandsstücke
Mousse de différentiel

BB38 ×1
14305026
板レンチ
Wrench
Mutternschlüssel
Clé

C 22~29

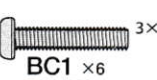

BC1 ×6
19805859
3×15mm丸ビス
Screw
Schraube
Vis

BA1 ×2
19804159
3×10mm丸ビス
Screw
Schraube
Vis

BB2 ×8
50579
3×10mm段付ビス
Step screw
Paßschraube
Vis décollétée



BA2 ×1
19804418
3×10mmフラットビス
Screw
Schraube
Vis



BB6 ×1
19804201
3×18mm皿ビス
Screw
Schraube
Vis



BC2 ×2
19808156
3×16mm皿ビス
Screw
Schraube
Vis



BA3 ×4
19805696
3×8mm皿ビス
Screw
Schraube
Vis

C

BA5 ×4
19805754
3×8mmタッピングビス
Tapping screw
Schneidschraube
Vis taraudeuse

BC3 ×4
50575
2.6×10mmタッピングビス
Tapping screw
Schneidschraube
Vis taraudeuse

BB9 ×4
19805893
1.6×4mmキャップスクリュー
Cap screw
Zylinderkopfschraube
Vis à tête cylindrique

BB10 ×2
19805777
3×2.5mmイモネジ
Grub screw
Madenschraube
Vis pointeau

BC4 ×2
19805991
3mmロックナット (薄)
Lock nut (thin)
Sicherungsmutter
(dünn)
Ecrou nylstop (fin)

BB12 ×2
19805897
3mmフランジナット
Flange nut
Kragenmutter
Ecrou à flasque

BC5 ×4
19808244
3mmナット
Nut
Mutter
Ecrou

BC6 ×2
50587
3mmスプリングワッシャー
Spring washer
Federscheibe
Rondelle resort

BC7 ×4
10309
2mmワッシャー (小)
Washer
Beilagscheibe
Rondelle

BC8 ×4
50588
2mmEリング
E-Ring
Circlip

BC9 ×4
19804205
5mmビローボール
Ball connector
Kugelkopf
Connecteur à rotule

BC10 ×2
19803426
6×7mmボールカラー
Ball collar
Kugelhülse
Bague de rotule

BB15 ×2
19804345
6mmビローボールナット
Ball connector nut
Kugelkopf-Mutter
Ecrou-connecteur à rotule

BB16 ×3
19804206
5mmビローボールナット
Ball connector nut
Kugelkopf-Mutter
Ecrou-connecteur à rotule

BA12 ×4
53008
1150ベアリング
Ball bearing
Kugellager
Roulement à billes

BA13 ×8
94392
850ベアリング
Ball bearing
Kugellager
Roulement à billes

BC11 ×2
19804199
3×3mmスペーサー
Spacer
Distanzring
Entretoise

BC12 ×2
53539
3×1.5mmスペーサー
Spacer
Distanzring
Entretoise

BC13 ×4
12685035
3×19mmリンクピン
Link pin
Gelenkboizen
Axe d'articulation

BC14 ×1
15395023
フロントスタビライザーロード
Front stabilizer rod
Vordere Stabilisatorstange
Barre stabilisatrice avant

BC15 ×1
19804447
フロントスタビホルダーL
Front stabilizer holder L
Vorderer Stabilisator-Halter L
Support du stabilisateur avant G

BC16 ×1
19804447
フロントスタビホルダーR
Front stabilizer holder R
Vorderer Stabilisator-Halter R
Support du stabilisateur avant D

BC17 ×1
13405051
ステアリングプレート
Steering plate
Lenkungsplatte
Plaque de direction

BC18 ×2
19805800
3×32mmターンバックルシャフト
Turnbuckle shaft
Spann-Achse
Biellette à pas inversés

BC19 ×2
19804236
3×28mmターンバックルシャフト
Turnbuckle shaft
Spann-Achse
Biellette à pas inversés

BB23 ×2
50594
2×10mmシャフト
Shaft
Achse
Axe

BB24 ×2
19440664
1.6×10.4mmシャフト
Shaft
Achse
Axe

BC20 ×1
14305620
クロスメンバー
Cross member
Form-Querträger
Traverse profilée

BB35 ×2
19440664
クロススライダー
Cross joint
Kreuzzapfen
Joint en croix

BB36 ×4
50953
6mmアジャスター
Adjuster
Einstellstück
Chape à rotule

BC21 ×4
50596
5mmアジャスター
Adjuster
Einstellstück
Chape à rotule

BB37 ×2
19805922
デフスポンジ
Diff sponge
Abstandsstücke
Mousse de différentiel

D 30~50

BB1 ×4
19805895
3×20mm丸ビス
Screw
Schraube
Vis

BA1 ×1
19804159
3×10mm丸ビス
Screw
Schraube
Vis

BD1 ×1
19805636
3×6mm丸ビス
Screw
Schraube
Vis

BD2 ×1
19804394
2.6×10mmバインドビス
Screw
Schraube
Vis

BD3 ×4
19443023
2×6mm丸ビス
Screw
Schraube
Vis

BD4 ×3
19805662
3×10mmフランジタッピングビス
Flange tapping screw
Kragenschraube
Vis taraudeuse à flasque

BD5 ×1
19804392
3×10mmタッピングビス
Tapping screw
Schneidschraube
Vis taraudeuse

BA5 ×1
19805754
3×8mmタッピングビス
Tapping screw
Schneidschraube
Vis taraudeuse

BC3 ×1
50575
2.6×10mmタッピングビス
Tapping screw
Schneidschraube
Vis taraudeuse

BD6 ×4
50573
2×8mmタッピングビス
Tapping screw
Schneidschraube
Vis taraudeuse

BA6 ×3
50578
3×10mmタッピングビス
Tapping screw
Schneidschraube
Vis taraudeuse

BA7 ×2
50576
3×3mmイモネジ
Grub screw
Madenschraube
Vis pointeau

BD7 ×4
19805557
4mmフランジロックナット
Flange lock nut
Sicherungsmutter
Ecrou nylstop à flasque

BB12 ×2
19805897
3mmフランジナット
Flange nut
Kragenmutter
Ecrou à flasque

BD8 ×5
94690
2mmロックナット
Lock nut
Sicherungsmutter
Ecrou nylstop

BA8 ×1
50586
3mmワッシャー
Washer
Beilagscheibe
Rondelle

BD9 ×4
19805758
2mmワッシャー
Washer
Beilagscheibe
Rondelle

BC11 ×4
19804199
3×3mmスペーサー
Spacer
Distanzring
Entretoise

BD10 ×4
19804653
6mmボール
Ball
Kugel
Bille

BD11 ×1
19804154
5mmビローボール (2mmネジ)
Ball connector
Kugelkopf
Connecteur à rotule

BC8 ×8
50588
2mmEリング
E-Ring
Circlip

BD12 ×2
19804189
リヤピストンロッド
Rear piston rod
Hintere Kolbenstange
Axe de piston arrière

BD13 ×2
19804650
フロントピストンロッド
Front piston rod
Vordere Kolbenstange
Axe de piston avant

BD14 ×1
12500037
3×85mm両ネジシャフト
Threaded shaft
Gewindestange
Tige filetée

BD15 ×4
19808277
シリンダーエンド
Cylinder end
Zylinderende
Bouchon d'amortisseur

BD16 ×4
84292
ダンパーシャフトガイド
Shaft guide
Stangenführung
Guide d'axe

BD17 ×4
50597
3mmOリング (赤)
O-ring (red)
O-Ring (rot)
Joint torique (rouge)

BD18 ×4
19805385
ラバーブッシュ
Rubber bushing
Gummihülse
Bague en caoutchouc

BD19 ×4
19805486
オイルシール (赤)
Oil seal (red)
Ölabdichtung (rot)
Joint d'étanchéité (rouge)

BB34 ×4
19804552
ブッシュベース
Bushing base
Hülsenbasis
Entretoise

BD20 ×1
13455898
アンテナポスト
Antenna post
Antennenstange
Pied d'antenne

メガレンチ ×1
15494002
Mutterschlüssel
Clé

ナイロンバンド ×6
Nylon band 50595
Nylonband
Collier en nylon

ダンパーオイル (黄・#400) ×1
Damper oil 54710
Dämpfer-Öl
Huile pour amortisseurs

マジックテープ (9×150mm) ×2
Touch fastener tape 19805343
Klebband
Bande de fixation

BD21 ×1
15395025
ウイングステー
Wing stay
Spoilerstrebe
Cadre de maintien
de l'aïeron

BD22 ×2
19804776
ウイングマウント
Wing mount
Spoilerhalterung
Support d'aïeron

BD23 ×2
19805631
ウイングワッシャー
Washer
Beilagscheibe
Rondelle

BC21 ×2
50596
5mmアジャスター
Adjuster
Einstellstück
Chape à rotule

BD24 ×1
50197
スナップピン (大)
Snap pin (large)
Federstecker (groß)
Epingle métallique
(grande)

BD25 ×2
51537
スナップピン (小)
Snap pin (small)
Federstecker (klein)
Epingle métallique
(petite)

BD26 ×3
50197
スナップピン (小)
Snap pin (small)
Federstecker (klein)
Epingle métallique
(petite)

TAMIYA

両面テープ (黒・20×120mm) ×1
Double-sided tape (black) 50171
Doppelklebeband (schwarz)
Bande adhésive double face (noir)

両面テープ (黒・20×120mm) ×1
Double-sided tape (black) 50171
Doppelklebeband (schwarz)
Bande adhésive double face (noir)

EGRESS BLACK EDITION



●走らせない時は
バッテリーを必ずはずしておきましょう。

AFTER MARKET SERVICE CARD

When purchasing Tamiya replacement parts, please take or send this form to your local Tamiya dealer so that the parts required can be correctly identified and supplied. Please note that specifications, availability and price are subject to change without notice.

KUNDENNACHBETREUUNGS-KARTE

Wenn Sie Tamiya-Ersatzteile kaufen möchten, nehmen Sie bitte zur Unterstützung dieses Formular mit zu Ihrem örtlichen Fachhändler. Bezüglich der Angaben, der Lagerhaltung der Artikel und der Preise sind Änderungen vorbehalten.

SERVICE APRES-VENTE

LISTE DE PIÈCES DETACHÉES

Afin de vous permettre de vous procurer des pièces de rechange Tamiya, amenez cette liste à votre point de vente Tamiya qui ne manquera pas de vous renseigner. Veuillez noter que les caractéristiques, disponibilité et prix peuvent changer sans avis préalable.

PARTS CODE

11825048 Body
11835039 Wing
11825049 Undertray
13405078 Lower Deck
13405079 Upper Deck
19000526 A Parts
19000716 B Parts
19000257 C Parts
19005275 G Parts
19005277 H Parts
19115326 J Parts
19115327 K Parts
19115328 L Parts
19115329 N Parts
10115065 P Parts (Gray)
10225051 *2 X Parts (x1)
10225052 *2 Y Parts (x1)
19335066 ※ Wheels (Front x2, Rear x2) (Black)
19335641 Plastic Gear Bag (PG1 x2, PG2, PG3, PG4 x1)
19804545 Front Tire (x2)
19805536 Rear Tire (x2)
13405080 *2 Suspension Arm Reinforcing Plate (PA1 x1)
13450295 ※ Upright L (PA7) (Gold)
13450296 ※ Upright R (PA8) (Gold)
19804652 Rear Coil Spring (PA5 x2)
19805322 Front Coil Spring (PA6 x2)
19804651 ※ Rear Damper Cylinder (PA3 x2) (Gun Metal)
19804649 ※ Front Damper Cylinder (PA4 x2) (Gun Metal)
19804773 5x4mm Round Bushing (PC7 x5)
19804507 4x15mm Pipe Nut (PC3 x2)
19804505 Chassis Stay (PC1 x4)
13455211 *3 6x25mm Pipe Nut (PC2 x1)
19804509 *2 5x6mm Round Bushing (PC6 x2)
19804510 5x6mm Hexagonal Bushing (PC4 x2)
15700147 Steel Ball (3/32 inch) (BA15 x12)
16294011 Sponge Tape (15x150mm) (x1)
19805696 *4 3x8mm Countersunk Head Screw (Black) (BA3 x4)
19805732 Hexagonal Mount (BA21 x4)
13482002 2x36mm Shaft (BA18)
13485024 5x24mm Shaft (BA17)
19804500 Front Differential Joint (BA20 x2)
19804501 Rear Differential Joint (BA19 x2)
19804843 *2 14mm Washer (BA10 x2)
19804159 3x10mm Screw (Black) (BA1 x10)
19804286 3x6mm Countersunk Head Screw (BA4 x4)
19804418 3x10mm Flat Screw (Black) (BA2 x10)
19805754 3x8mm Tapping Screw (Black) (BA5 x10)
14305026 Wrench
19804448 Rear Stabilizer Holder (L, R) (BB20, BB21)
19805358 Rear Arm Mount (BB30 x2)
15395024 Rear Stabilizer Rod (BB19)
19803266 3mm Lock Nut (BB11 x10)
19805897 3mm Flanged Nut (BB12 x10)
13455130 *2 Stabilizer Ball (BB33 x1)
19804417 3x18mm Flat Screw (Black) (BB3 x10)
19804201 *2 3x18mm Countersunk Head Screw (Black) (BB6 x2)
19804206 *2 5mm Ball Connector Nut (3mm) (Black) (BB16 x4)
19805626 8mm Ball (BB13 x4)

19804774 Tapered Bushing (Long) (BB31 x2)
19805895 3x20mm Screw (Black) (BB1 x10)
19804775 3x42mm Countersunk Head Screw (BB4 x2)
19805745 3x25mm Countersunk Head Screw (BB5 x2)
19805977 3x12mm Countersunk Head Screw (Black) (BB7 x5)
19400797 *2 3x42mm Turnbuckle Shaft (BB22 x1)
19804345 6mm Ball Connector Nut (BB15 x10)
19805611 5x9mm Ball Connector (BB14 x5)
19805893 1.6x4mm Cap Screw (BB9 x10)
19805777 3x2.5mm Grub Screw (Black) (BB10 x10)
19804552 *2 Bushing Base (BB34 x4)
13455243 Undertray Mount (BB32)
13580033 3x22mm Tube (BB25)
19804246 5x0.5mm Spacer (BB27 x5)
13455745 5x5.2mm Spacer (BB26 x1)
19440664 *2 1.6x10.4mm Shaft, Cross Joint (BB24, BB35 x2, BB10 x3)
19805922 Differential Sponge (BB37 x10)
13405051 Steering Plate (BC17)
19804447 Front Stabilizer Holder (L, R) (BC15, BC16)
14305620 Cross Member (BC20)
15395023 Front Stabilizer Rod (BC14)
19805859 *2 3x15mm Screw (Black) (BC1 x4)
19808244 3mm Nut (Silver) (BC5 x10)
19804199 3(5.5)x3mm Spacer (BC11 x10)
19808156 3x16mm Countersunk Head Screw (Black) (BC2 x2)
19805991 3mm Lock Nut (Thin) (BC4 x4)
19804205 5mm Ball Connector (Black) (BC9 x4)
12685035 *4 3x19mm Link Pin (BC13 x1)
19803426 6x7mm Ball Collar (Black) (BC10 x4)
19805800 3x32mm Turnbuckle Shaft (Black) (BC18 x2)
19804236 3x28mm Turnbuckle Shaft (Black) (BC19 x2)
15395025 Wing Stay (BD21)
15494002 Wrench (7/8)
19804394 2.6x10mm Binding Screw (Black) (BD2 x5)
19804392 3x10mm Tapping Screw (Black) (BD5 x10)
19804154 5mm Ball Connector (2mm Screw) (Black) (BD11 x2)
19805636 3x6mm Screw (BD1 x2)
19805662 3x10mm Flanged Tapping Screw (Black) (BD4 x5)
19805557 4mm Flanged Lock Nut (BD7 x4)
13455898 Antenna Post (BD20)
19805631 Rosette Washer (BD23 x4)
19808277 Cylinder End (BD15 x4)
19804650 Front Piston Rod (BD13 x2)
19804189 Rear Piston Rod (BD12 x2)
19443023 *2 2x6mm Screw (BD3 x2)
19805758 2mm Washer (BD9 x5)
19804653 6mm Ball (BD10 x4)
19804776 Wing Mount (BD22 x2)
19805385 *2 Rubber Bushing (BD18 x2)
19805486 *2 Oil Seal (Red) (BD19 x2)
19805343 Touch Fastener Tape (9x150mm) (x2)
12500037 3x85mm Threaded Shaft (BD14)
14305243 Motor Mount (PB11)
13450321 *2 Differential Inner L (PB12)
13450322 Front Differential Inner R (PB14)
13450323 Rear Differential Inner R (PB13)
19804858 1680 Ball Bearing (PB1 x4)
13405082 Front Damper Stay (PB16)
13405081 Rear Damper Stay (PB15)

13485025 Propeller Shaft
15700022 One-Way Bearing (PB10)
12595197 Rear Propeller Joint (Torque Splitter) (PB9)
12595062 Rear Propeller Joint (PB7)
12595063 Front Propeller Joint (PB8)
19803284 *2 Swing Shaft (PB6 x2)
19401761 *2 Wheel Axle (PB5 x2)
14305227 Gearbox Plate
19804502 Differential Nut (PB3 x2)
19804470 *2 Differential Screw (PB2 x1, etc.)
16095010 Antenna Pipe (30cm) (Black)
19494255 Stickers (a, b), Masking Stickers
11057620 Instructions
50038 Tool Set (Box Wrench, 1.5/2.5mm Hex Wrench, BA7 x4)
50171 Heat Resistant Double-Sided Tape (Black) (x5)
50197 Snap Pin Set (BD24 x10, BD26 x5)
50357 22T Pinion Gear (BA22 x1, etc.)
50380 E-Ring Set (BA9 x4, BB17 x7, etc.)
50573 2x8mm Tapping Screw (BD6 x10)
50575 2.6x10mm Tapping Screw (BC3 x5)
50576 3mm Grub Screw (BA7 x10)
50578 *3 3x10mm Countersunk Head Tapping Screw (BA6 x10)
50579 *3 3x10mm Step Screw (Black) (BB2 x5)
50581 3x12mm Countersunk Head Tapping Screw (BB8 x10)
50586 3mm Washer (BA8 x15)
50587 3mm Spring Washer (BC6 x15)
50588 8mm E-Ring (BC8 x15)
50594 2x10mm Shaft (BB23 x10)
50595 Nylon Band w/Metal Hook (x10)
50596 *2 5mm Adjuster (BC21 x6)
50597 3mm O-Ring (Red) (BD17 x10)
50953 6mm Adjuster (BB36 x16)
51417 *2 6026 Ball Thrust Bearing (BA11 x2, BA16 x8)
51537 6mm Snap Pin (BD25 x15)
53008 *3 1150 Ball Bearing (BA12 x4)
53042 Ball Diff Grease
53439 Anti-Wear Grease (3g)
53539 5.5mm Spacer Set (BB28, BC12 x4, etc.)
53569 *4 Wheel Hub (PA2 x4, BB9, BB23 x5)
54710 Silicone Oil (#400)
10309 2mm Washer (Small) (BC7 x20)
49299 Differential Spring (PB4 x2)
84195 3mm O-Ring (Black) (BB29 x10)
84292 Shaft Guide (BD16 x4)
94386 830 Ball Bearing (BB18 x2)
94389 620 Ball Bearing (BA14 x2)
94392 *8 850 Ball Bearing (BA13 x2)
94690 2mm Lock Nut (BD8 x10)
87099 Cera-Grease HG

★This model includes exclusive parts which are not available from Tamiya Customer Service. Parts marked ※ have codes referring to standard color or spec parts. The special parts in this kit are not available.

A number with the symbol(*) shows the quantity of that Parts Code required to fully kit out one model.

