



Instruction Manual book

L-39 ALBATROS



ALL Balsa-PLY WOOD CONSTRUCTION.
COVERED WITH ORACOVER®

ITEM CODE: BH 141

95% ALMOST READY TO FLY

SPECIFICATION

- Wingspan: 1,450mm 57.09 in.
- Length : 1,860 mm 73.23 in.
- Weight : 4.3-4.6 kg 9.46-10.12 Lbs.

Parts listing required (not included).

- Radio : 08 channels.
- Servo : 08 size (29 x 13 x 30) mm.
- EDF: 90MM MIDI - FAN EVO/HET 650-68 -1.500
- Battery: 8S-LIPO-29,6V-6,000mAh
- Speed control: 120A

Electric gear retracts and nose gear retract 10Lb(5kg).
Not including electric gears (only including oleo struts)

Made in Vietnam.

This instruction manual is designed to help you build a great flying aeroplane. Please read this manual thoroughly before starting assembly of your **L-39 ALBATROS**. Use the parts listing below to identify all parts.

WARNING.

Please be aware that this aeroplane is not a toy and if assembled or used incorrectly it is capable of causing injury to people or property. WHEN YOU FLY THIS AEROPLANE YOU ASSUME ALL RISK & RESPONSIBILITY.

If you are inexperienced with basic R/C flight we strongly recommend you contact your R/C supplier and join your local R/C Model Flying Club. R/C Model Flying Clubs offer a variety of training procedures designed to help the new pilot on his way to successful R/C flight. They will also be able to advise on any insurance and safety regulations that may apply.

TOOLS & SUPPLIES NEEDED.

- Thick cyanoacrylate glue.
- 30 minute epoxy.
- 5 minute epoxy.
- Hand or electric drill.
- Assorted drill bits.
- Modelling knife.
- Straight edge ruler.
- 2mm ball driver.
- Phillips head screwdriver.
- 220 grit sandpaper.
- 90° square or builder's triangle.
- Wire cutters.
- Masking tape & T-pins.
- Thread-lock.
- Paper towels.

Some more parts.

HARDWARE PACK

Landing gear.....

SUGGESTION.

To avoid scratching your new airplane, do not unwrap the pieces until they are needed for assembly. Cover your workbench with an old towel or brown paper, both to protect the aircraft and to protect the table. Keep a couple of jars or bowls handy to hold the small parts after you open the bag.

PARTS LISTING.

FUSELAGE ASSEMBLY

- (1) Fuselage.

WING ASSEMBLY

- (1) Right wing half with pre-installed aileron.
- (1) Left wing half with pre-installed aileron.

Tail section assembly

- (1) Vertical stabilizer with pre-installed rudder.
- (1) Horizontal stabilizer with pre-installed elevator halves.

NOTE.

Please trial fit all the parts. Make sure you have the correct parts and that they fit and are aligned properly before gluing! This will assure proper assembly. **L-39 ALBATROS** ARF is hand made from natural materials, every plane is unique and minor adjustments may have to be made. However, you should find the fit superior and assembly simple. The painted and plastic parts used in this kit are fuel proof. However, they are not tolerant of many harsh chemicals including the following: paint thinner, C/A glue accelerator, C/A glue debonder and acetone. Do not let these chemicals come in contact with the colors on the covering and the plastic parts.

Caution:

this model is not a toy!

If you are a beginner to this type of powered model, please ask an experienced model flyer for help and support. If you attempt to operate the model without knowing what you are doing you could easily injure yourself or somebody else. Please keep your safety and well-being in mind at all times.

Important: before you start construction

Even if you have already built a large number of RC models please read right through these instructions and check all the kit components against the parts list. We have taken great trouble to keep construction as simple as possible, without making any compromises in the area of safety.

Note regarding the film covering

Minor creases or bubbles may develop in the film covering due to major fluctuations in weather conditions (temperature, humidity etc.); in rare cases you may even find a slight warp in a component. These minor faults are in the nature of film-covered built-up wooden structures, and can easily be corrected using a heat gun, as commonly used for modelling.

Creases: Blow warm air over the area and rub down with a soft cloth.

Wing warp: Hold the panel twisted gently in the opposite direction to the warp, and apply warm air to remove the creases from the covering.

Caution! do not heat the film more than is absolutely necessary. If the air or the iron is too hot, the film may melt and holes may be formed.

This model is highly pre-fabricated and can be built in a very short time. However, the work which you have to carry out is important and must be done carefully. The model will only be strong and fly well if you complete your tasks competently - so please work slowly and accurately.

When self-tapping screws have to be screwed into wood, apply a little white glue to prevent them shaking loose: just squirt white glue into the hole and fit the screw.

SAFETY PRECAUTION.

- + This is not a toy
- + Be sure that no other flyers are using your radio frequency
- + Wear safety glasses.
- + The glow plug clip must be securely attached to the glow plug.
- + Do not start the EDF if people are near.

REPLACEMENT LARGE PARTS

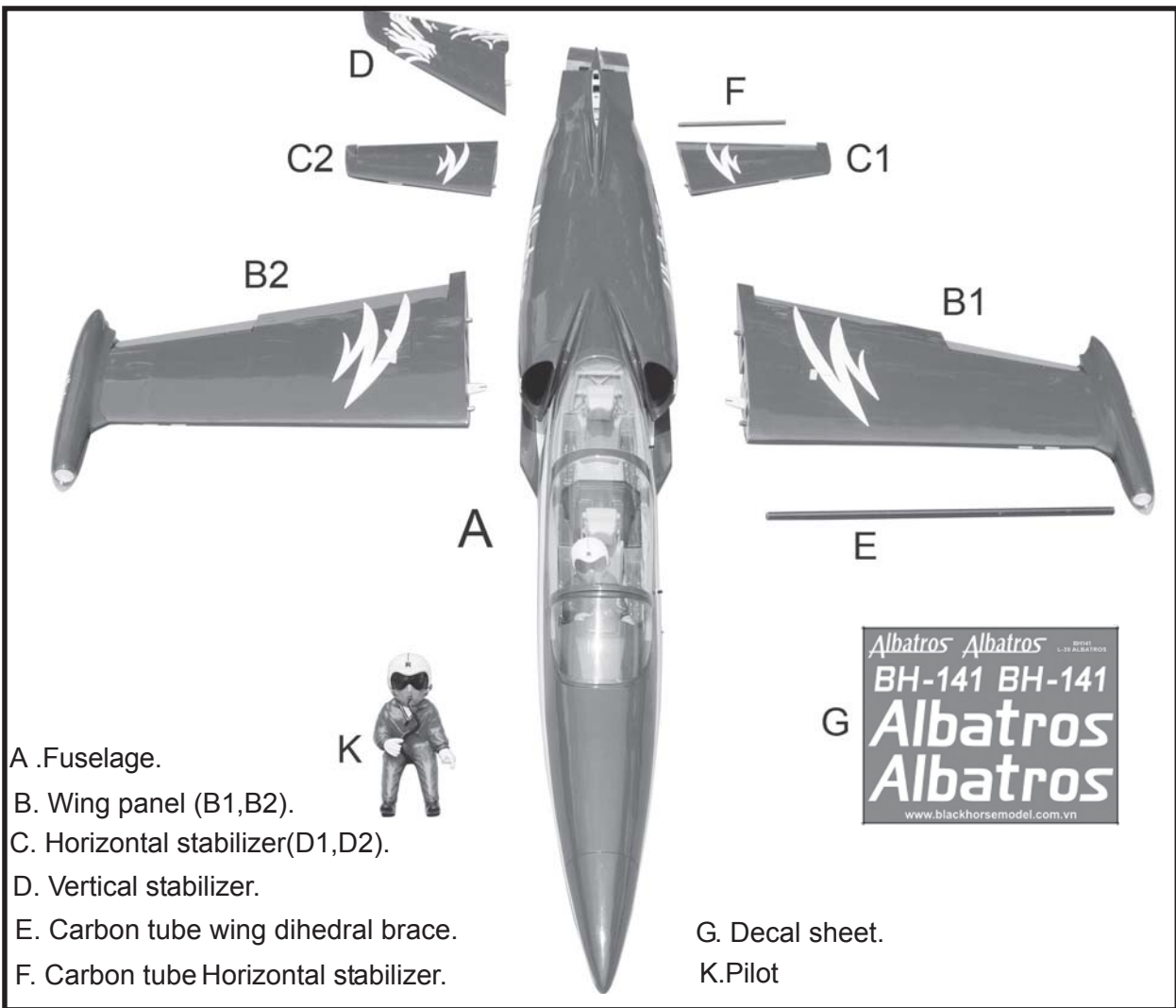

- A .Fuselage.
- B. Wing panel (B1,B2).
- C. Horizontal stabilizer(D1,D2).
- D. Vertical stabilizer.
- E. Carbon tube wing dihedral brace.
- F. Carbon tube Horizontal stabilizer.
- G. Decal sheet.
- K.Pilot

REPLACEMENT SMALL PARTS

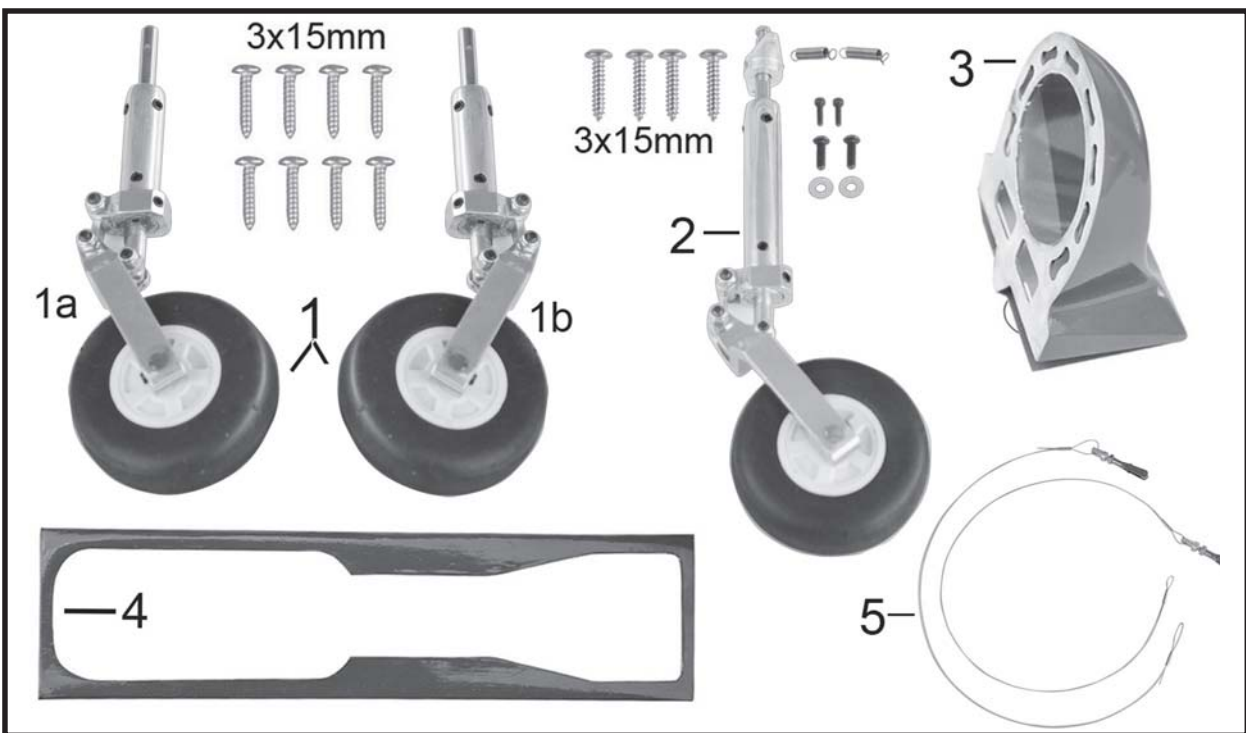

- 1.Oleo struts retracts.
- 2.Oleo strut retract nose gear.
- 3.Plastic parts of tail fuselage.
- 4.Plywood of nose gear
- 5.wire cable(nose gear)

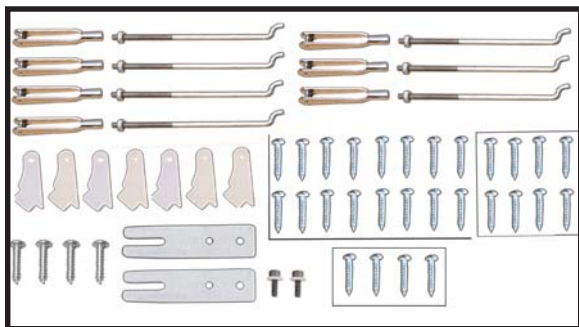

I. AILERON.

1.INSTALLING THE AILERON SERVOS.

☐ 1) Install the rubber grommets and brass eyelets onto the aileron servos.

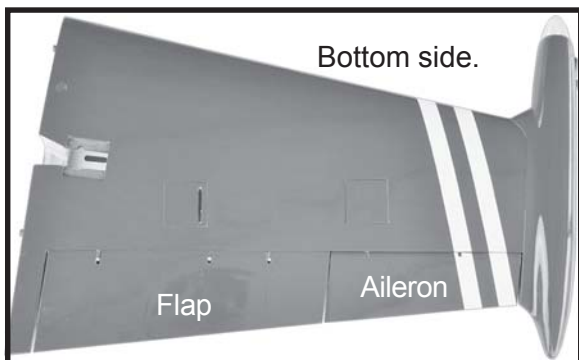

☐ 2) Using a modeling knife, remove the covering at position show below.

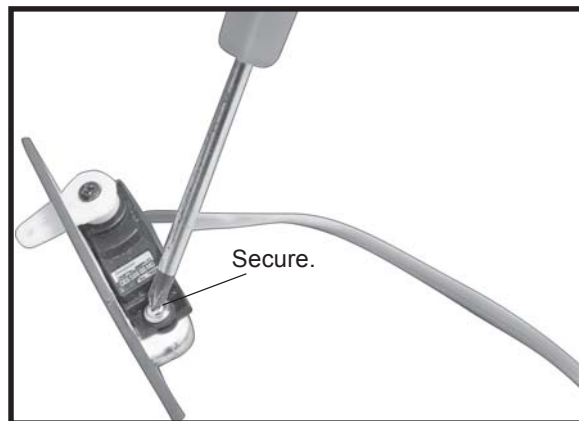
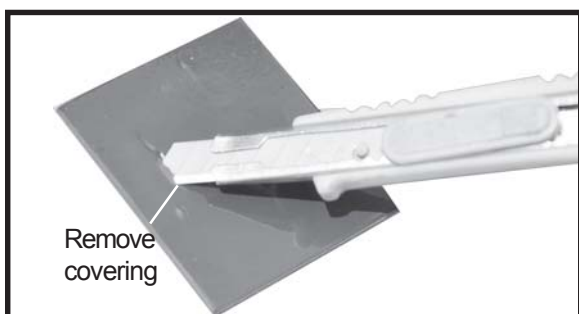
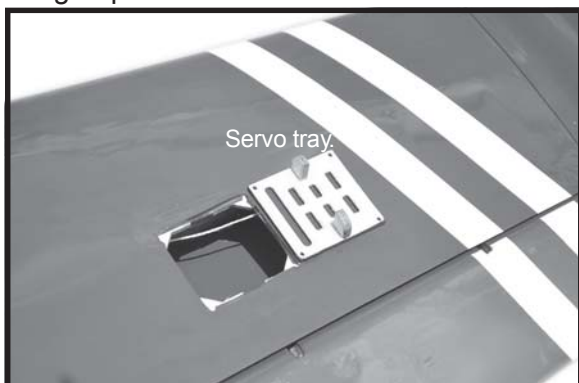

☐ 3) Using the thread as a guide and using masking tape, tape the servo lead to the end of the thread: carefully pull the thread out. When you have pulled the servo lead out, remove the masking tape and the servo lead from the thread.

☐ 4) Drill 1,6mm pilot holes through the block of wood for each of the four mounting screws provided with the servo.

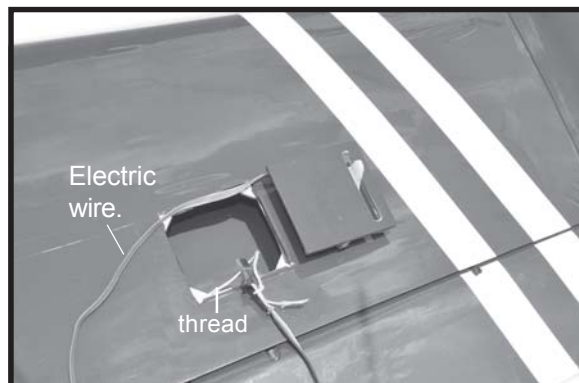

□ 5. Instal servo tray with aileron servo into the wing as same as picture below.

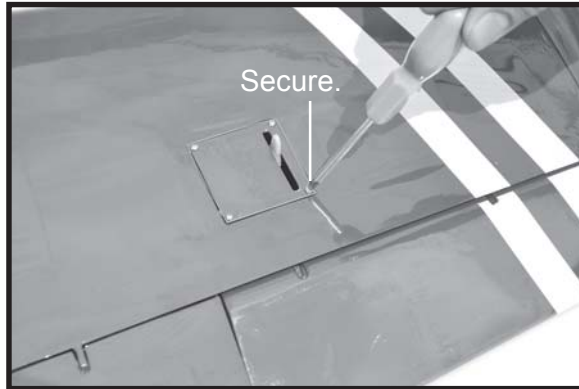
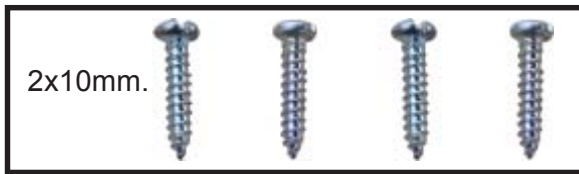

Repeat the procedure for the other wing half.

INSTALLING THE AILERON CONTROL HORN.

Aileron control horn

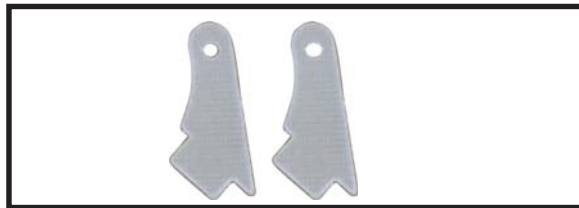

INSTALLING THE AILERON LINKAGES.

Installing the aileron linkages as pictures below.

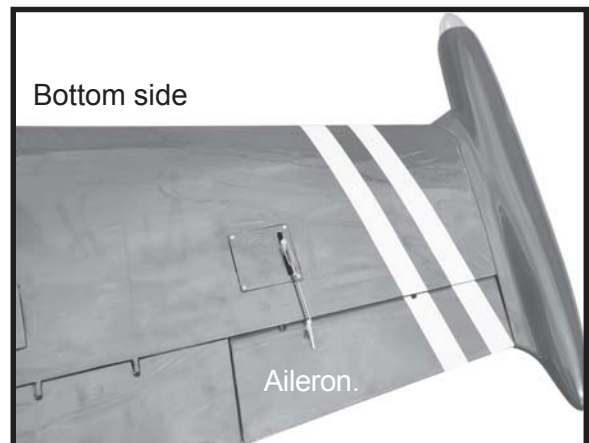
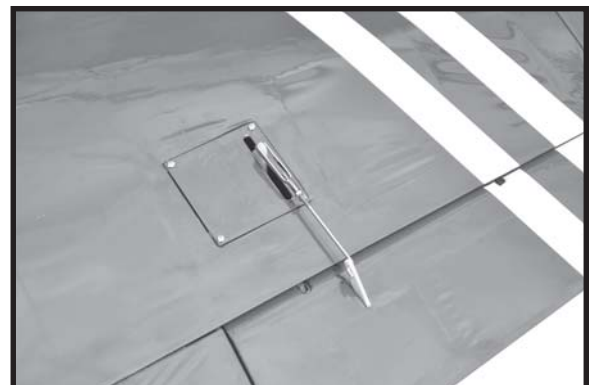
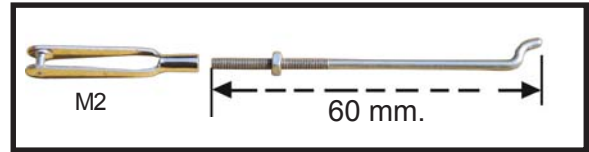

Repeat the procedure for the other wing half.

II. FLAP

1.INSTALLING THE FLAP SERVO

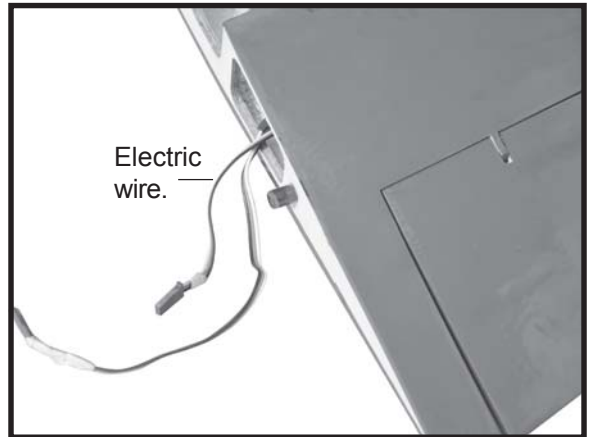
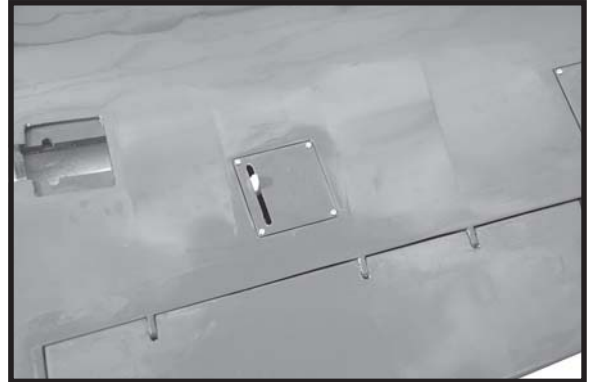
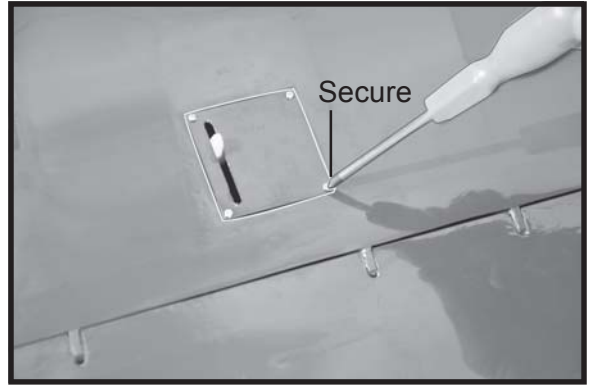
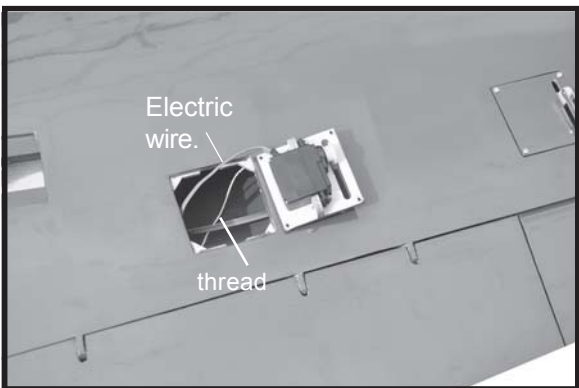
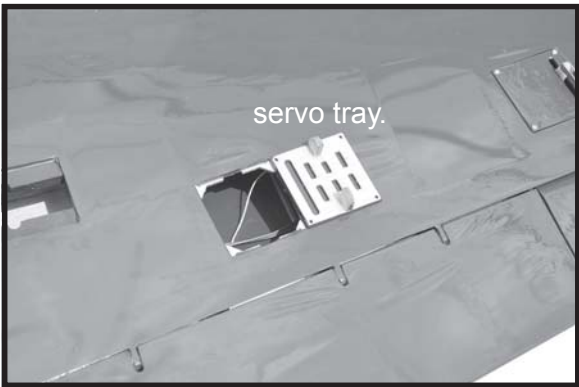
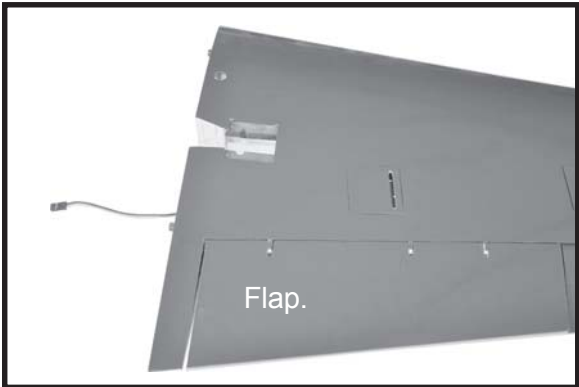

Repeat the procedure for the other wing half.

2.INSTALLING THE FLAP CONTROL HORN.

Install flap control horn as same as picture below.

Control horn Flap.

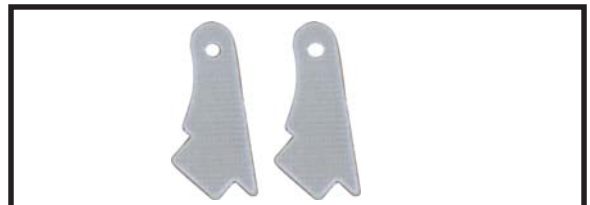

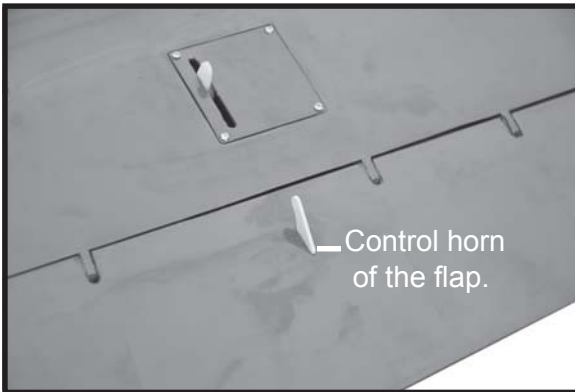
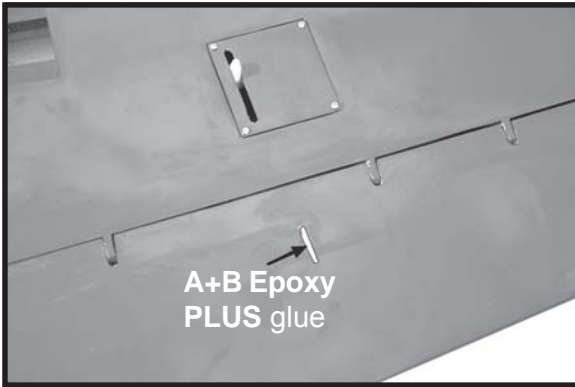

3.INSTALLING THE FLAP LINKAGES.

Installing the flap linkages as pictures below.

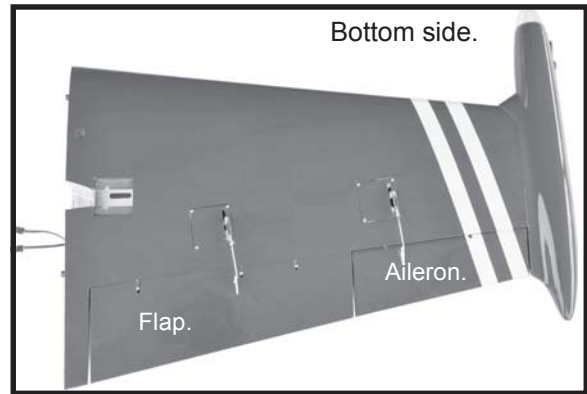
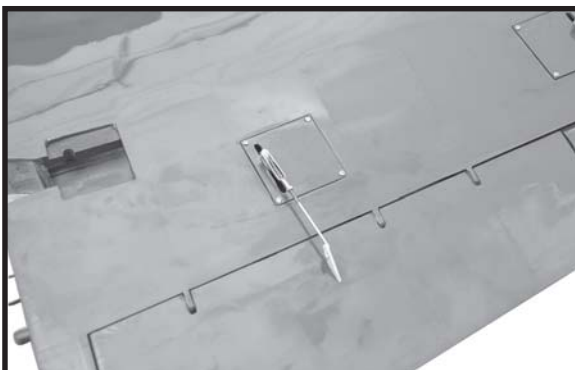
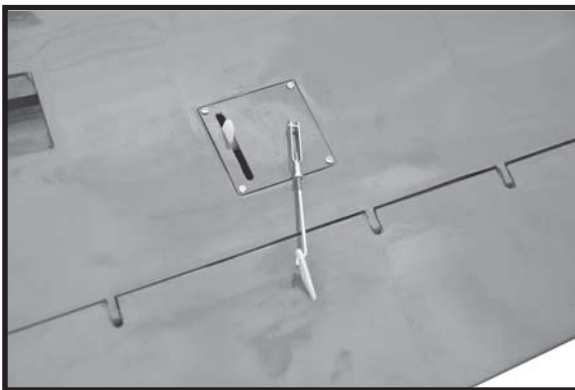
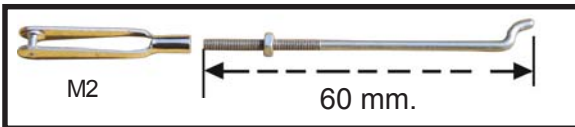

Repeat the procedure for the other wing half.

INSTALLING ELECTRIC GEAR RETRACTS.

PARTS REQUIRED

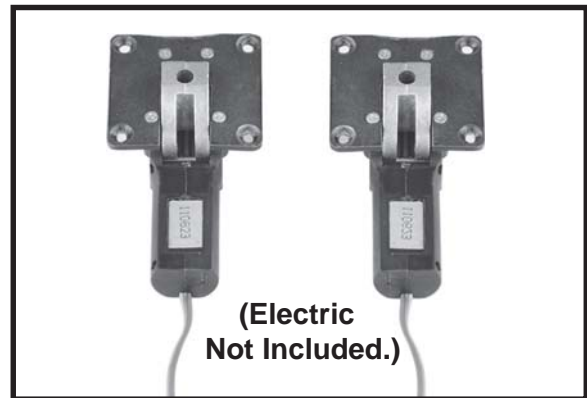

Only including oleo struts.



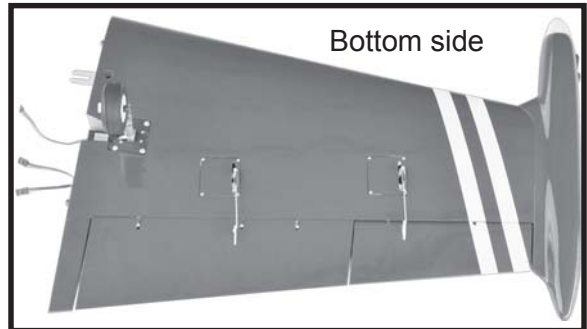
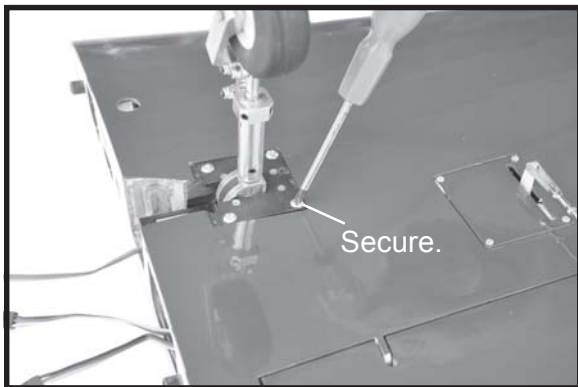
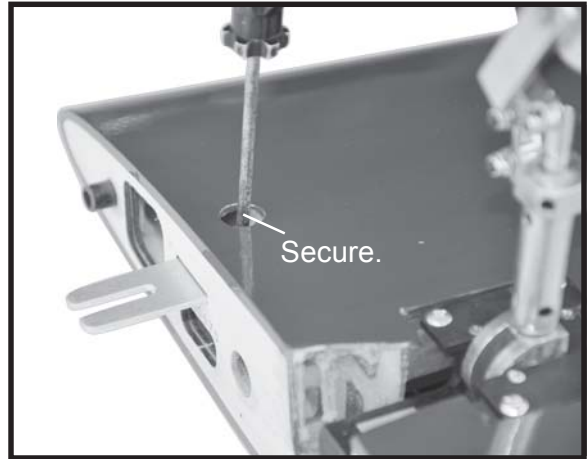
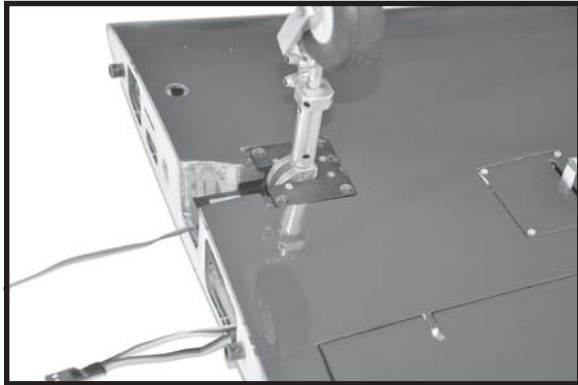
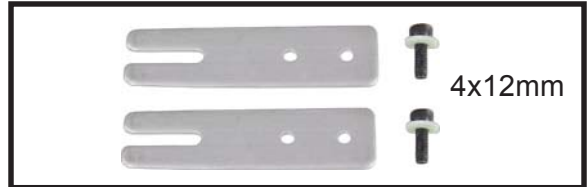

Repeat the procedure for the other gear.

INSTALLING ELECTRIC EDF-90MM.

(Not included)

See pictures below:

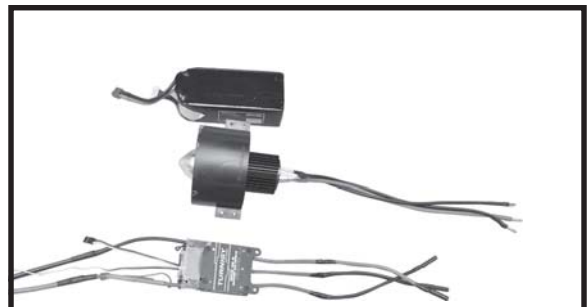
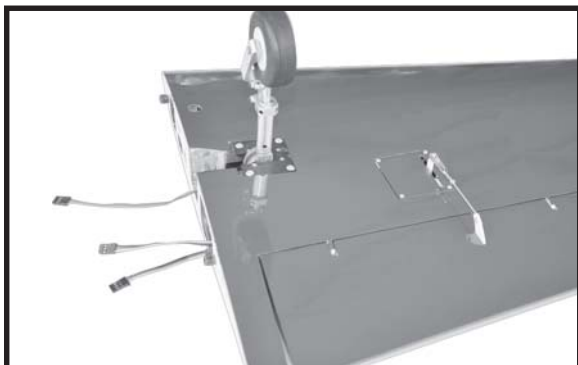

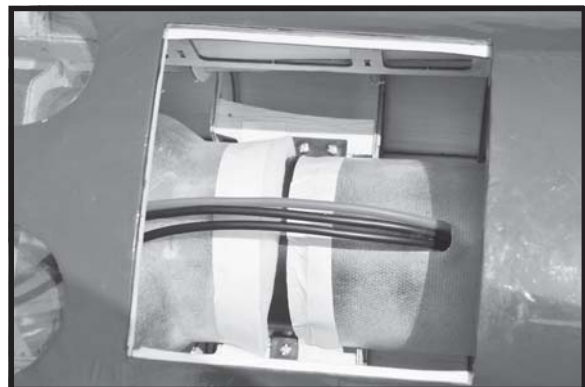
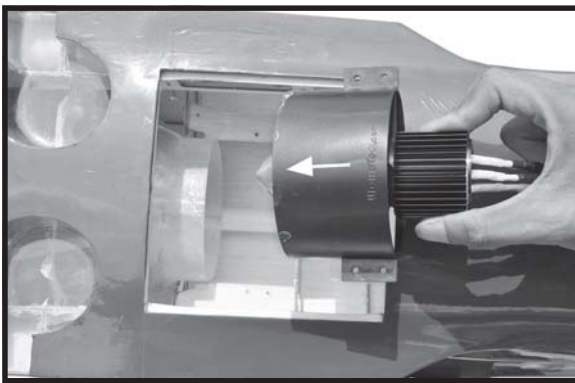
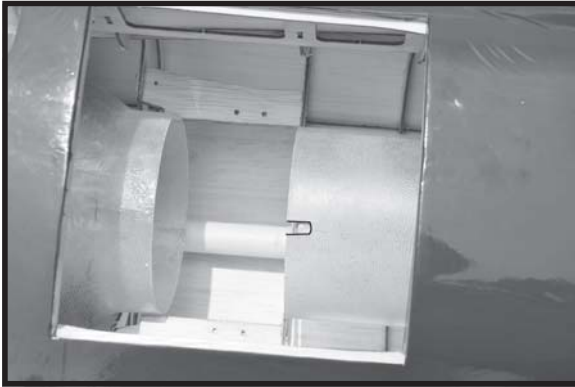
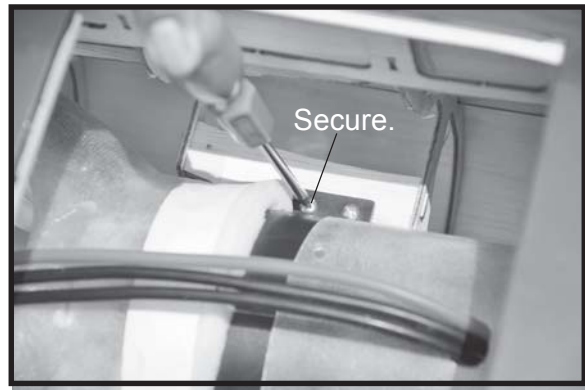
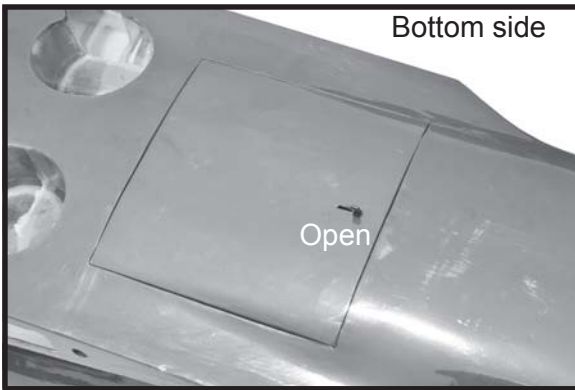

.Plastic parts of tail fuselage.

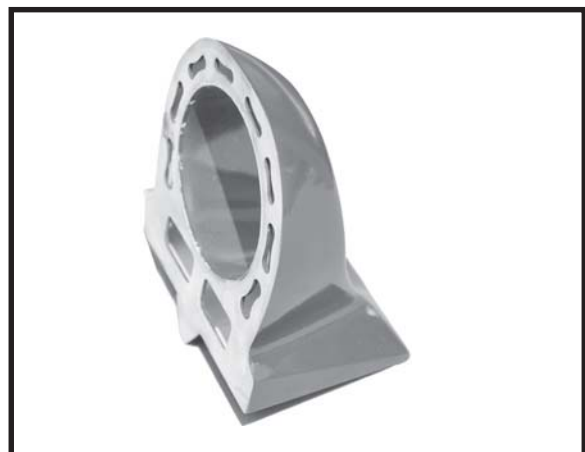
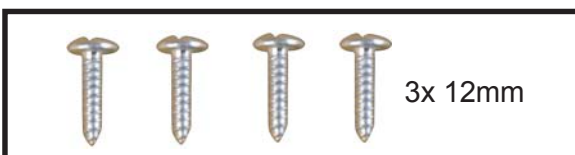

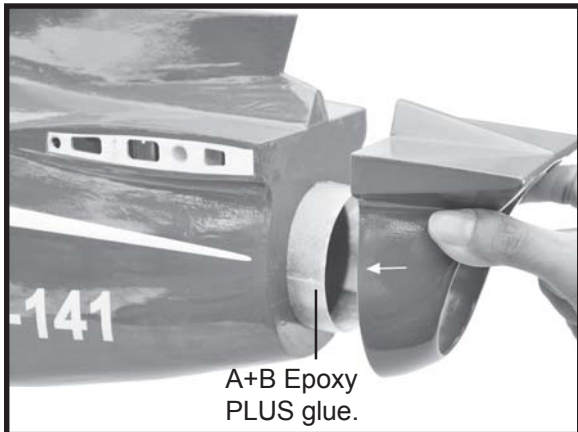
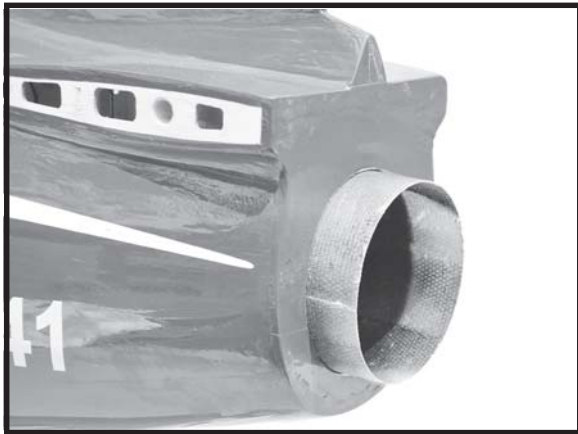

HORIZONTAL STABILIZER.

ELEVATOR SERVO INSTALLATION.

- 1. Install the rubber grommets and brass collets into the elevator servo. Test fit the servo into the servo tray.
- 2. Mount the servo to the tray using the mounting screws provided with your radio system.



□ **Horizontal stabilizer installation .**

See picture below.

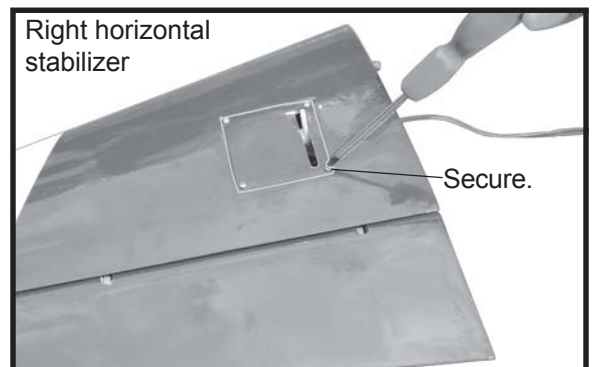
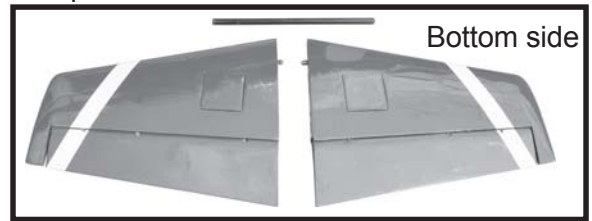

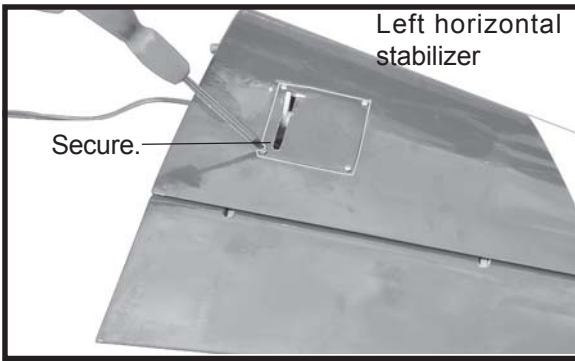

ELEVATOR CONTROL HORN INSTALLATION.

Elevator control horn install as same as the way of aileron control horn. Please see pictures below.

Control horn of elevator

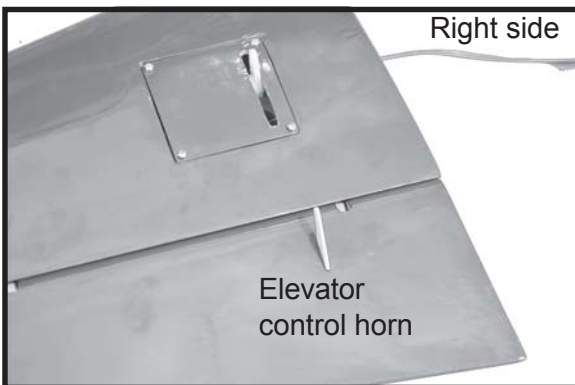
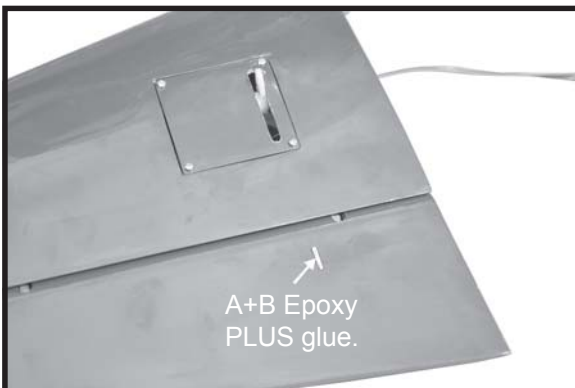
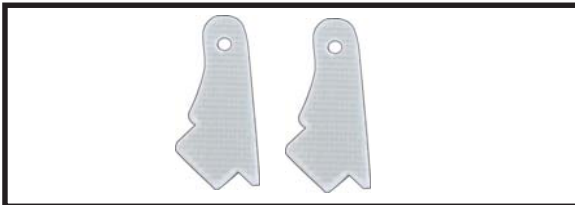

ELEVATOR PUSHROD INSTALLATION.

Elevator pushrod install as same as the way of aileron pushrod.

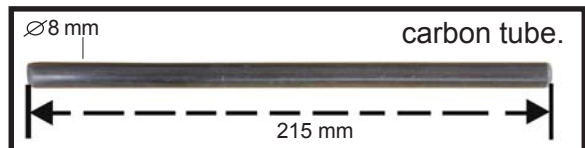
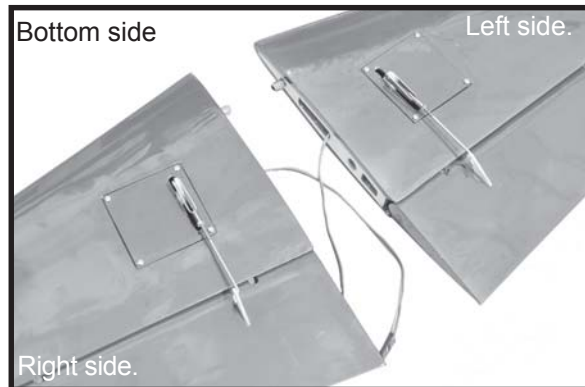
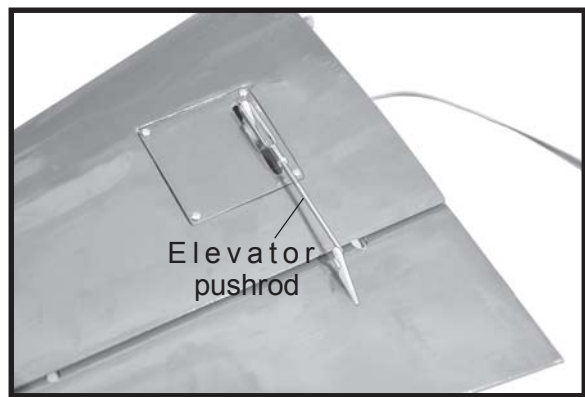
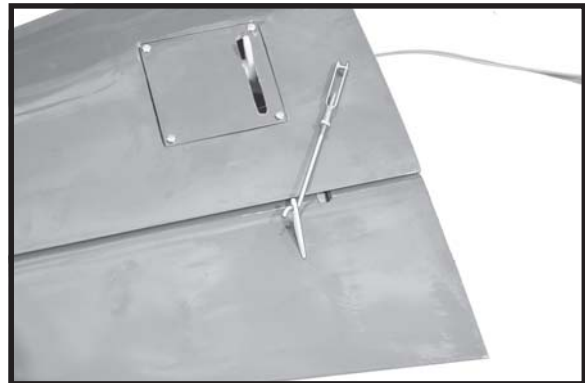
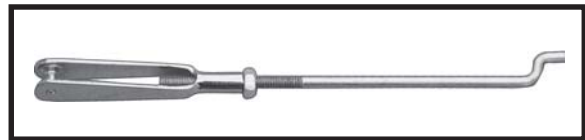
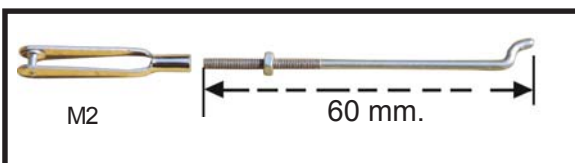

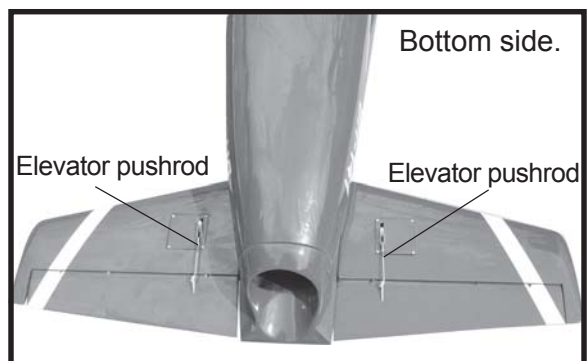
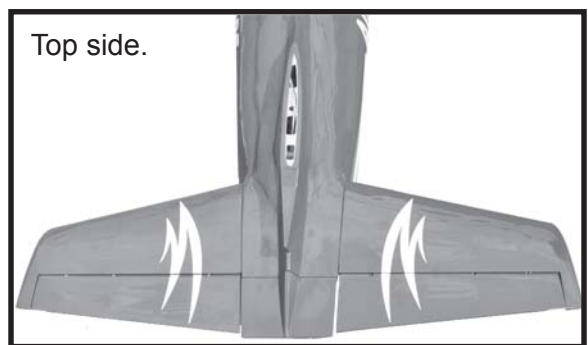
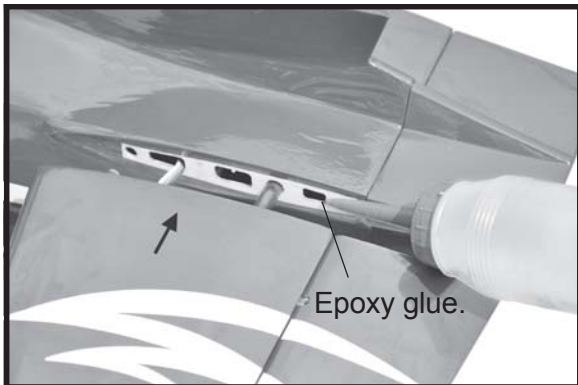
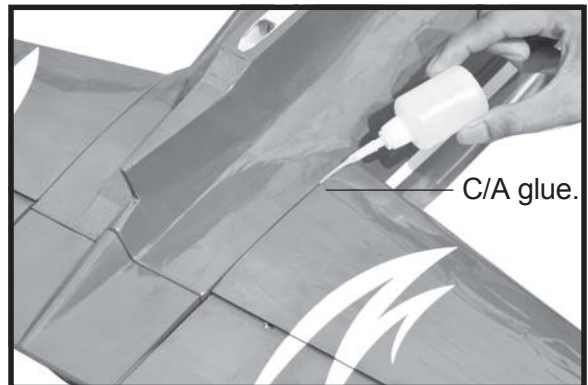
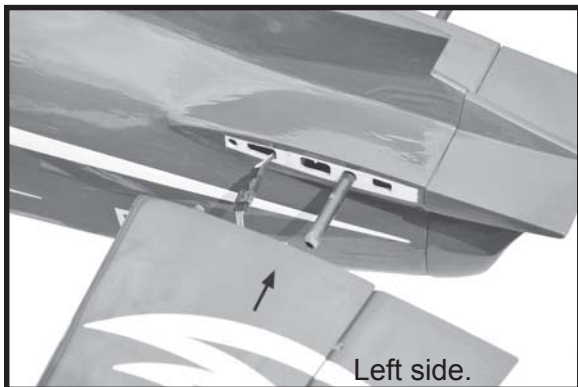
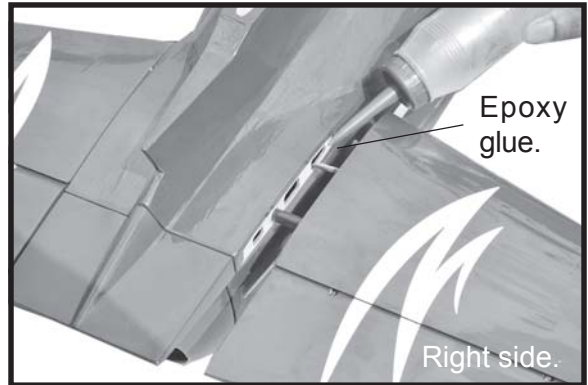
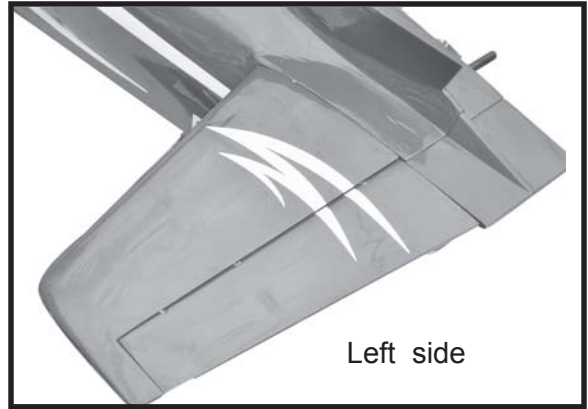
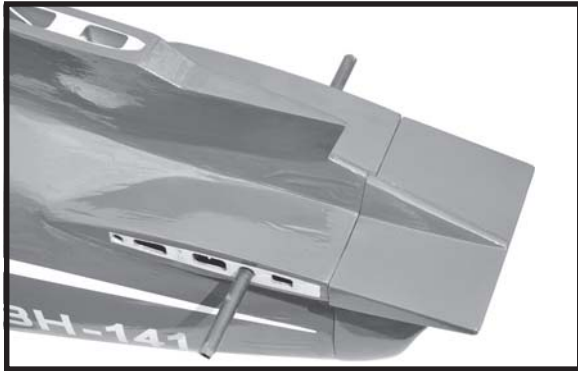

VERTICAL INSTALLATION

See picture below:



Rudder servo install as same as method of elevator servo.

See picture below:

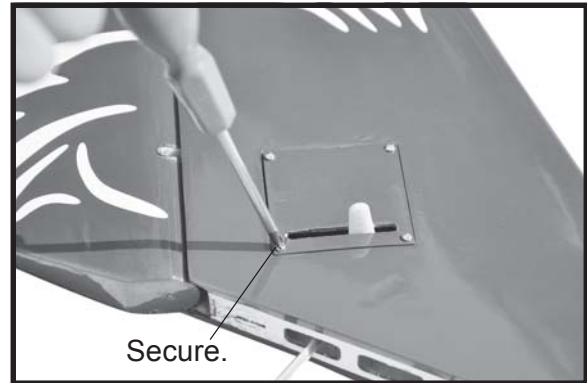

RUDDER CONTROL HORN INSTALLATION.

Rudder control horn install as same as the way of aileron control horn. Please see pictures below.

Control horn of Rudder

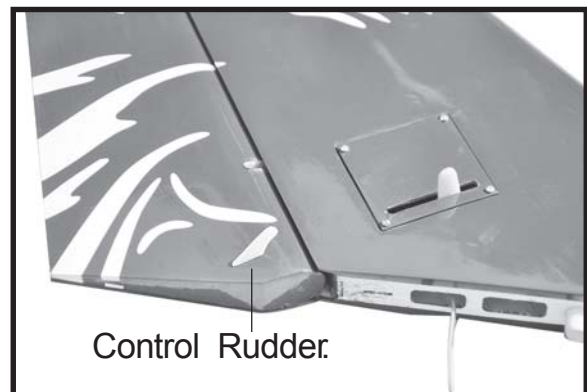
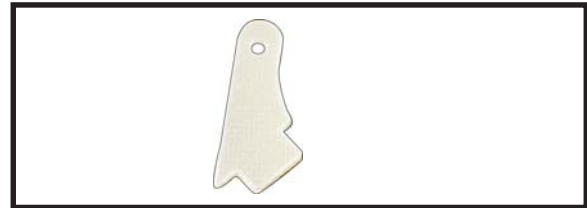

RUDDER PUSHROD INSTALLATION.

Rudder pushrod install as same as the way of aileron pushrod.

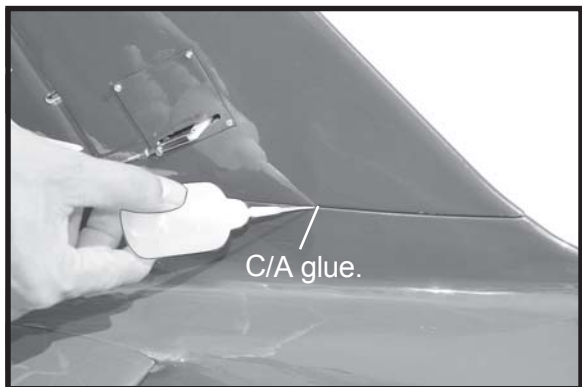
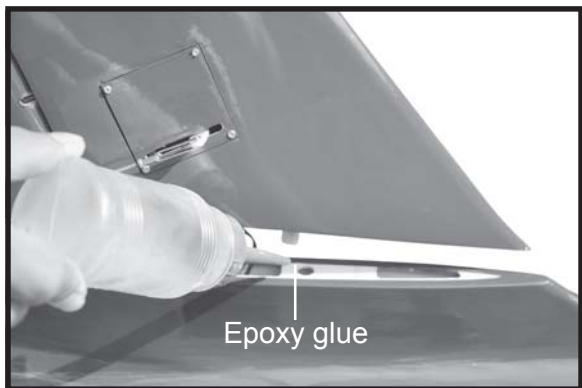
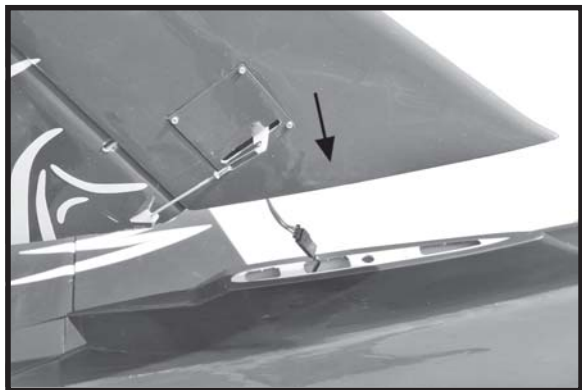
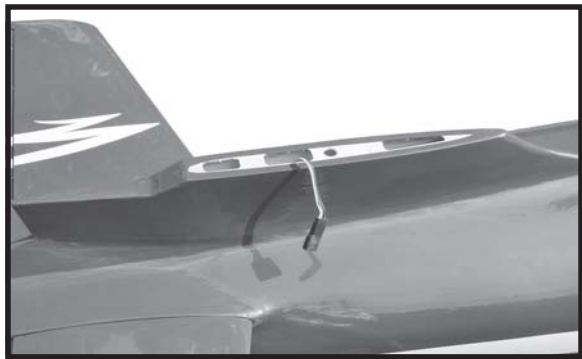
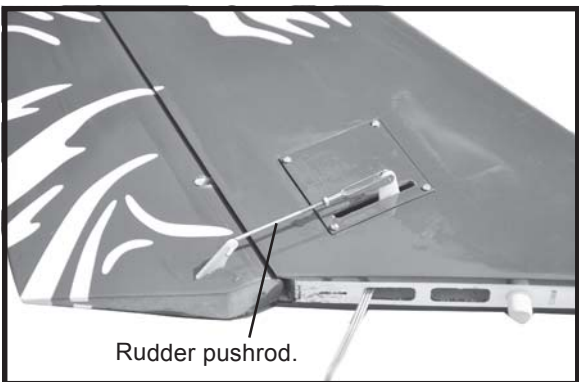
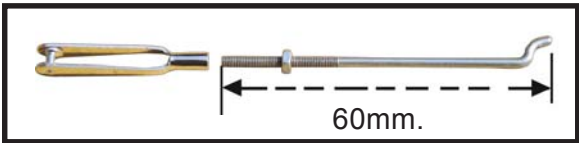



INSTALLING ELECTRIC NOSE GEAR RETRACT.

See picture below:



Only Including Oleo Strut Nose Gear.



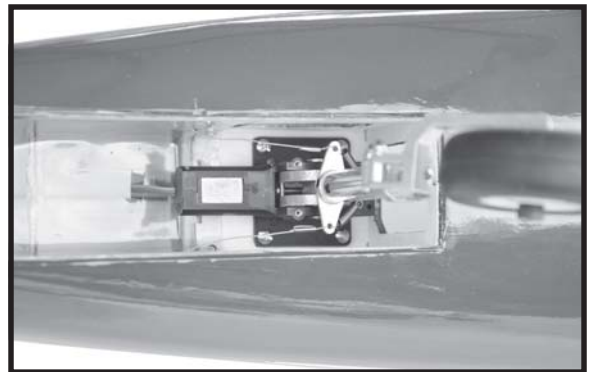
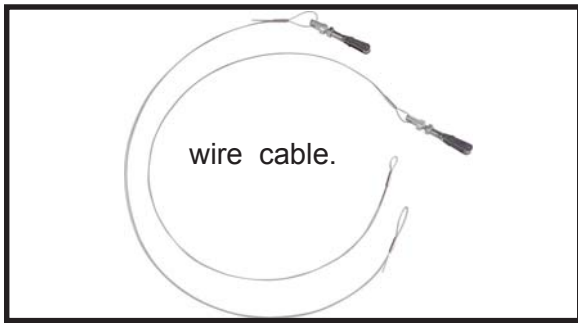

INSTALLING SERVO NOSE GEAR.

See picture below:

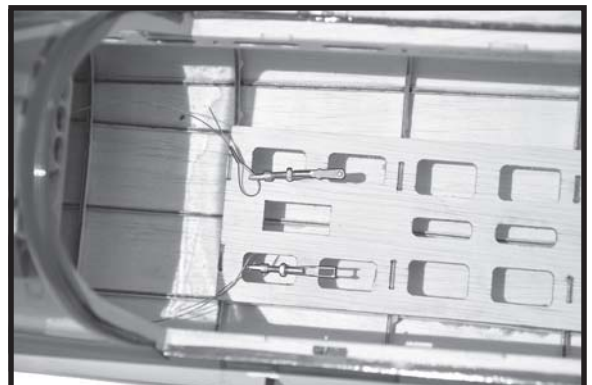
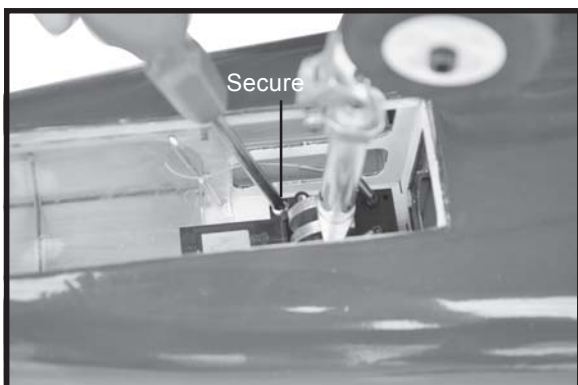
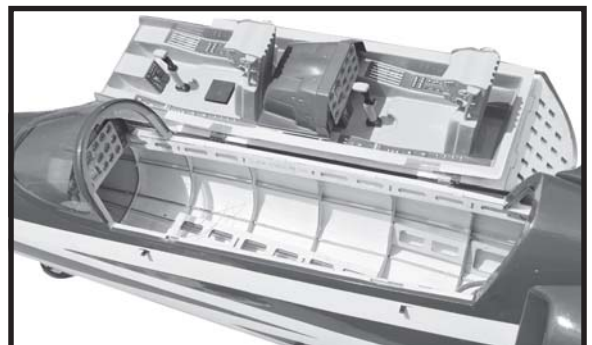
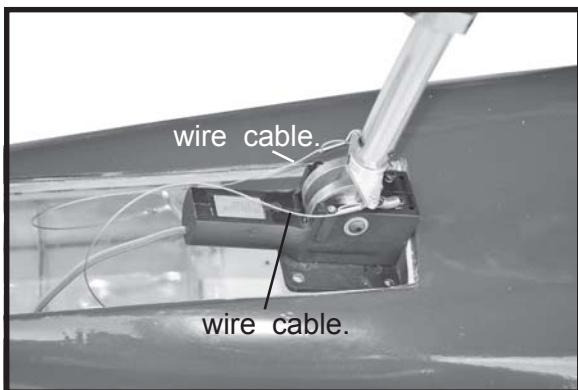
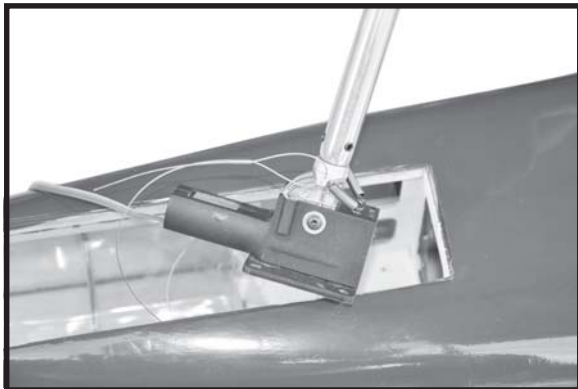

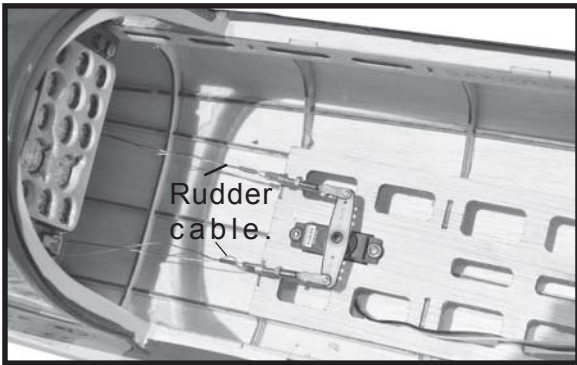
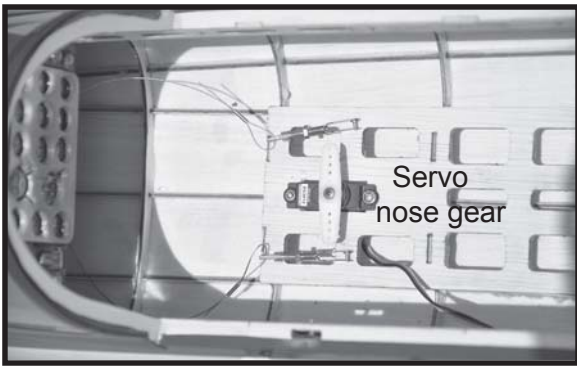

Ply wood of nose gear.

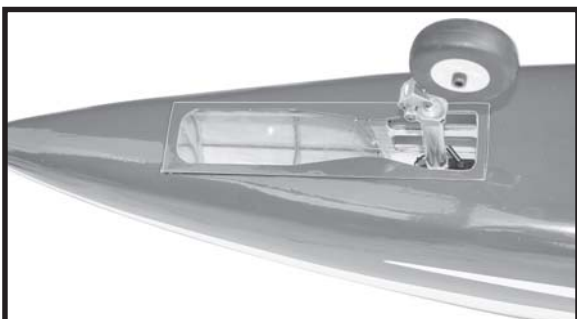
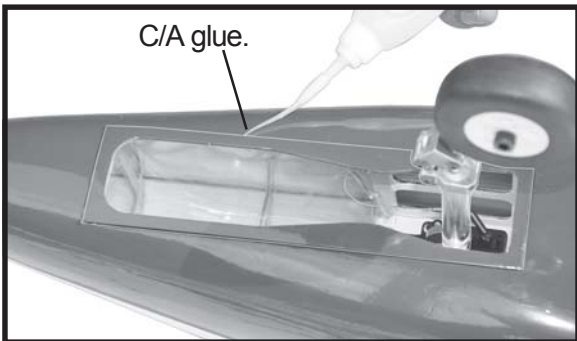

INSTALLING THE ESC-RECEIVER AND BATTERY.

- 1. Plug the servo leads and the switch lead into the receiver You may want to plug an aileron extension into the receiver to make plugging in the aileron servo lead easier when you are installing the wing . Plug the battery pack lead into the switch.

- 2. Wrap the receiver and battery pack in the protective foam to protect them from vibration. Use a rubber band or masking tape to hold the foam in place.

- 3. Position the battery pack and receiver is as picture below.

Do not permanently secure the receiver and battery until after balancing the model.

- 4. Using a 2mm drill bit, drill a hole through the side of the fuselage, near the receiver for the antenna to exit.

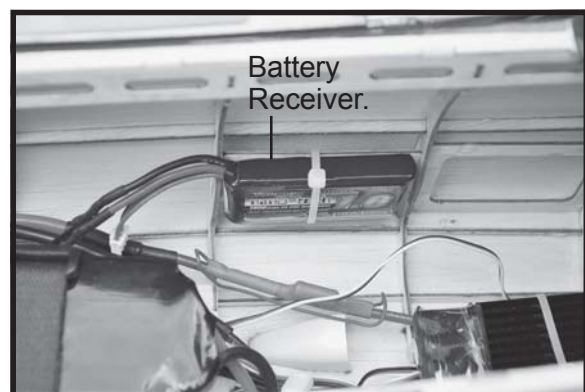
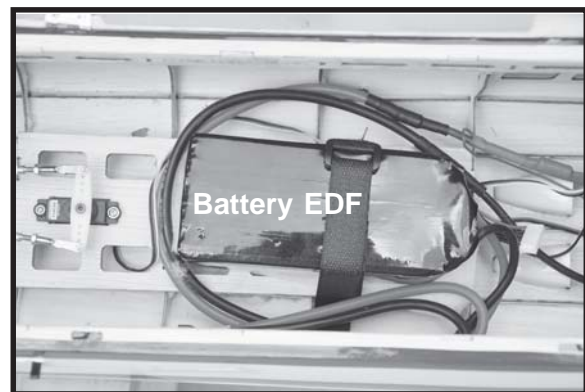
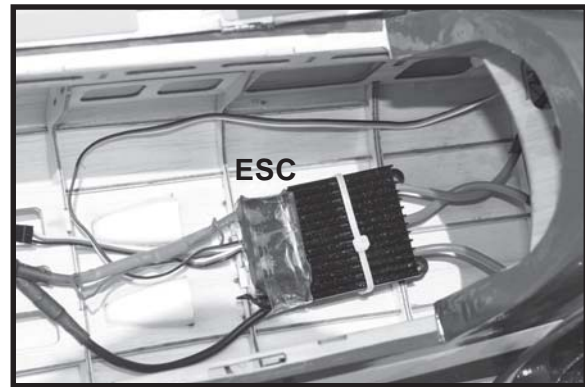
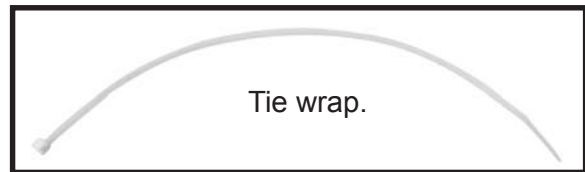



INSTALLING COCKPIT FUSELAGE .

See picture below:

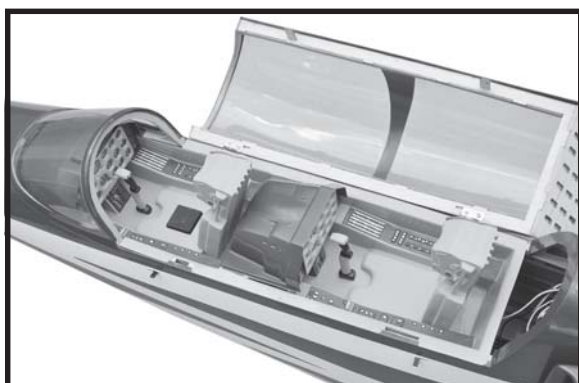
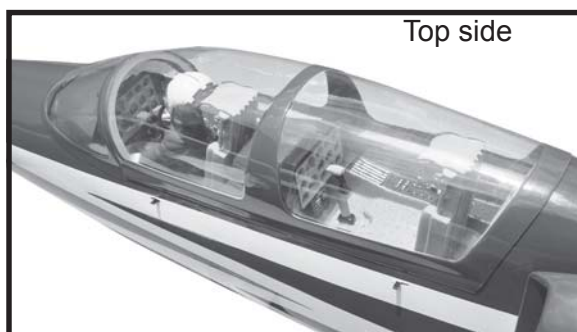
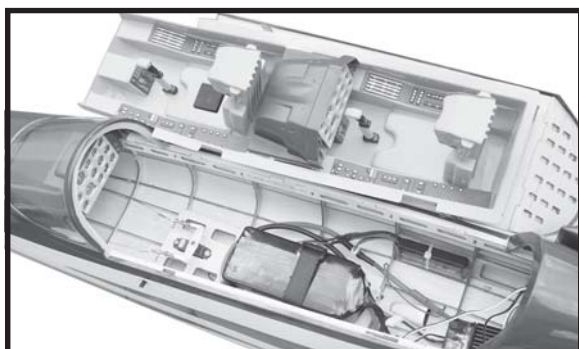

WING ATTACHMENT.

- 1. Locate the carbon tube wing dihedral brace.

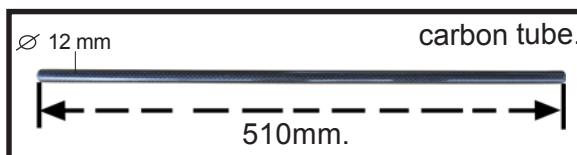

□ 2. Attach the carbon tube into the fuselage.

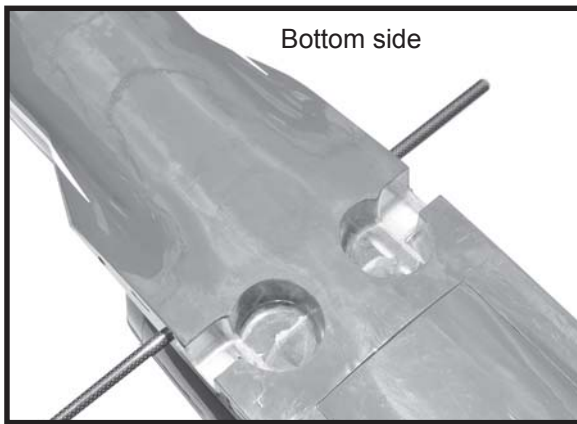

□ 3. Insert two wing panels as pictures below.

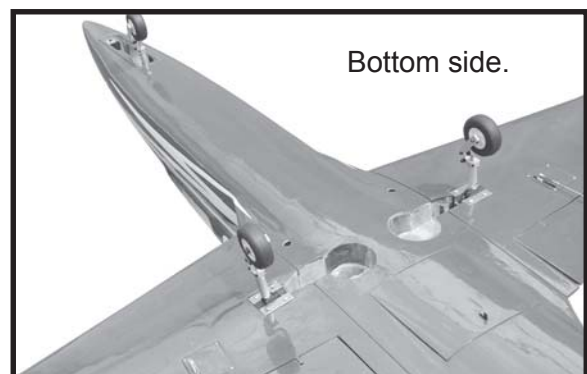
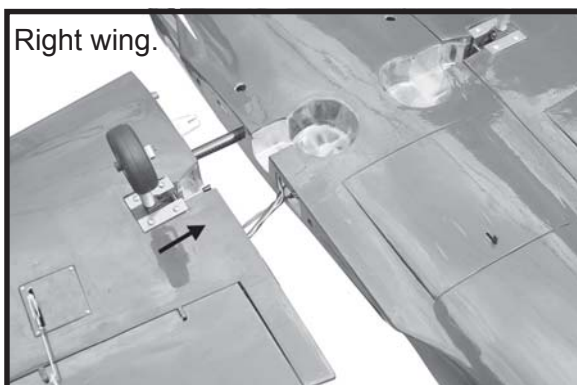
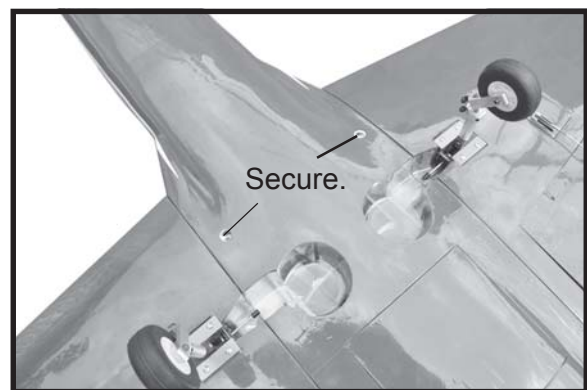
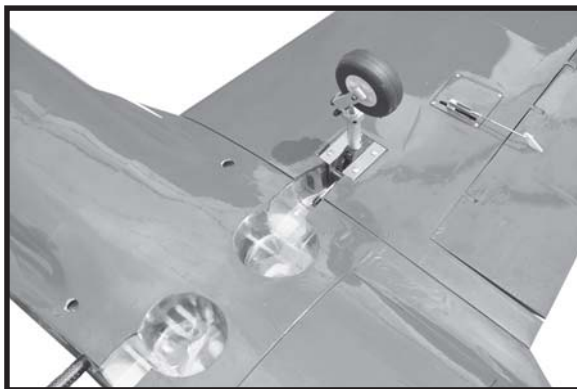
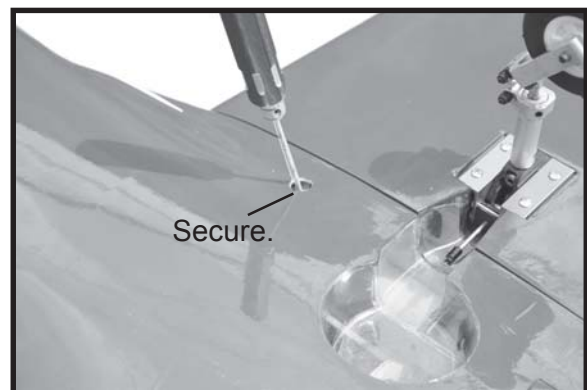
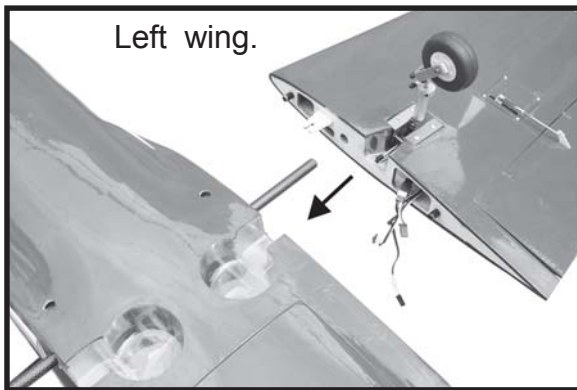
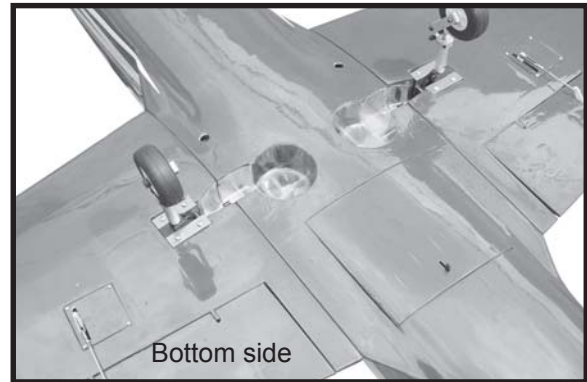

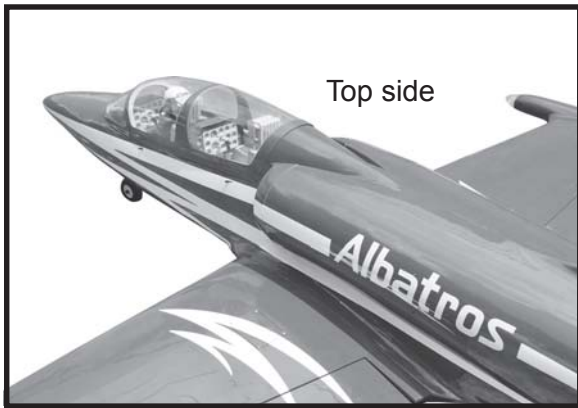

BALANCING.

☐ 1) It is critical that your airplane be balanced correctly. Improper balance will cause your plane to lose control and crash.

THE CENTER OF GRAVITY IS LOCATED **111 MM** BACK FROM THE LEADING EDGE OF THE WING.

☐ 2) Mount the wing to the fuselage. Using a couple of pieces of masking tape, place them on the top side of the wing **111 mm** back from the leading edge, at the fuselage sides.

☐ 3. Turn the airplane up side down. Place your fingers on the masking tape and carefully lift the plane .

Accurately mark the balance point on the top of the wing on both sides of the fuselage. The balance point is located **111 mm** back from the leading edge. This is the balance point at which your model should balance for your first flights. Later, you may wish to experiment by shifting the balance up to 10mm forward or back to change the flying characteristics. Moving the balance forward may improve the smoothness and arrow-like tracking, but it may then require more speed for take off and make it more difficult to slow down for landing. Moving the balance aft makes the model more agile with a lighter and snappier "feel". In any case, please start at the location we recommend .

With the wing attached to the fuselage, all parts of the model installed (ready to fly), and empty fuel tanks, hold the model at the marked balance point with the stabilizer level.

Lift the model. If the tail drops when you lift, the model is "tail heavy" and you must add weight* to the nose. If the nose drops, it is "nose heavy" and you must add weight* to the tail to balance.

*If possible, first attempt to balance the model by changing the position of the receiver battery and receiver. If you are unable to obtain good balance by doing so, then it will be necessary to add weight to the nose or tail to achieve the proper balance point.

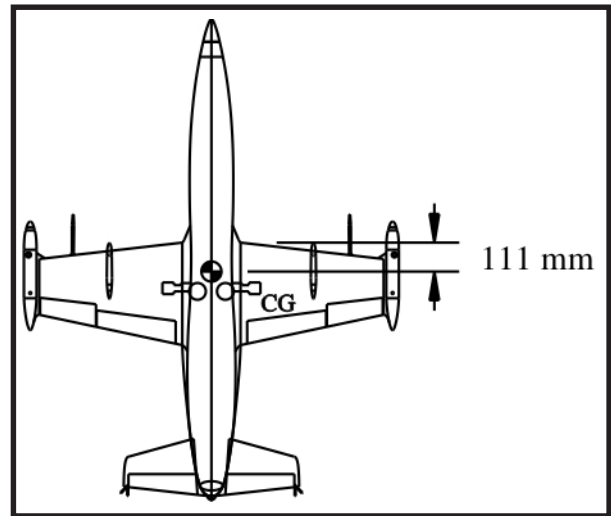

CONTROL THROWS.

▶ 1) We highly recommend setting up a plane using the control throws listed.

▶ 2) The control throws should be measured at the widest point of each control surface.

▶ 3) Check to be sure the control surfaces move in the correct directions.

Ailerons : 10 mm up 10 mm down

Flap : 30 mm

Elevator : 12 mm up 12 mm down

Rudder : 15 mm right 15 mm left

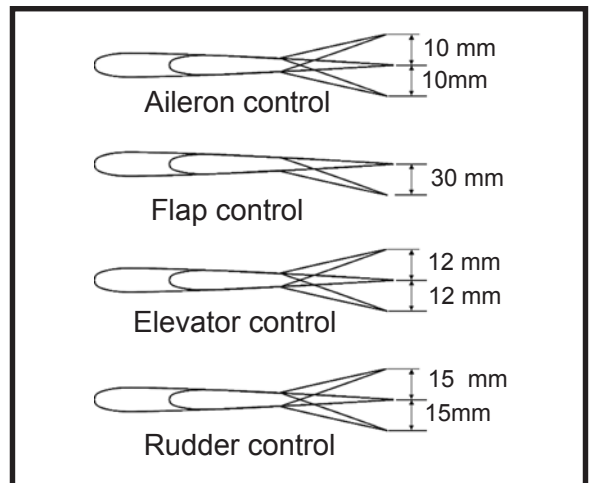

PRE-FLIGHT CHECK.

- ▶ 1) Completely charge your transmitter and receiver batteries before your first day of flying.
- ▶ 2) Check every bolt and every glue joint in your plane to ensure that everything is tight and well bonded.
- ▶ 3) Double check the balance of the airplane.
- ▶ 4) Check the control surface.
- ▶ 5) Check the receiver antenna . It should be fully extended and not coiled up inside the fuselage.
- ▶ 6) Properly balance the propeller.

We wish you many safe and enjoyable flights with your L-39 ALBATROS.