

# F-100D

*Super Sabre*



**SUPER** PNP  
Instruction Manual

**FLEX**  
INNOVATIONS  
[www.flexinnovations.com](http://www.flexinnovations.com)

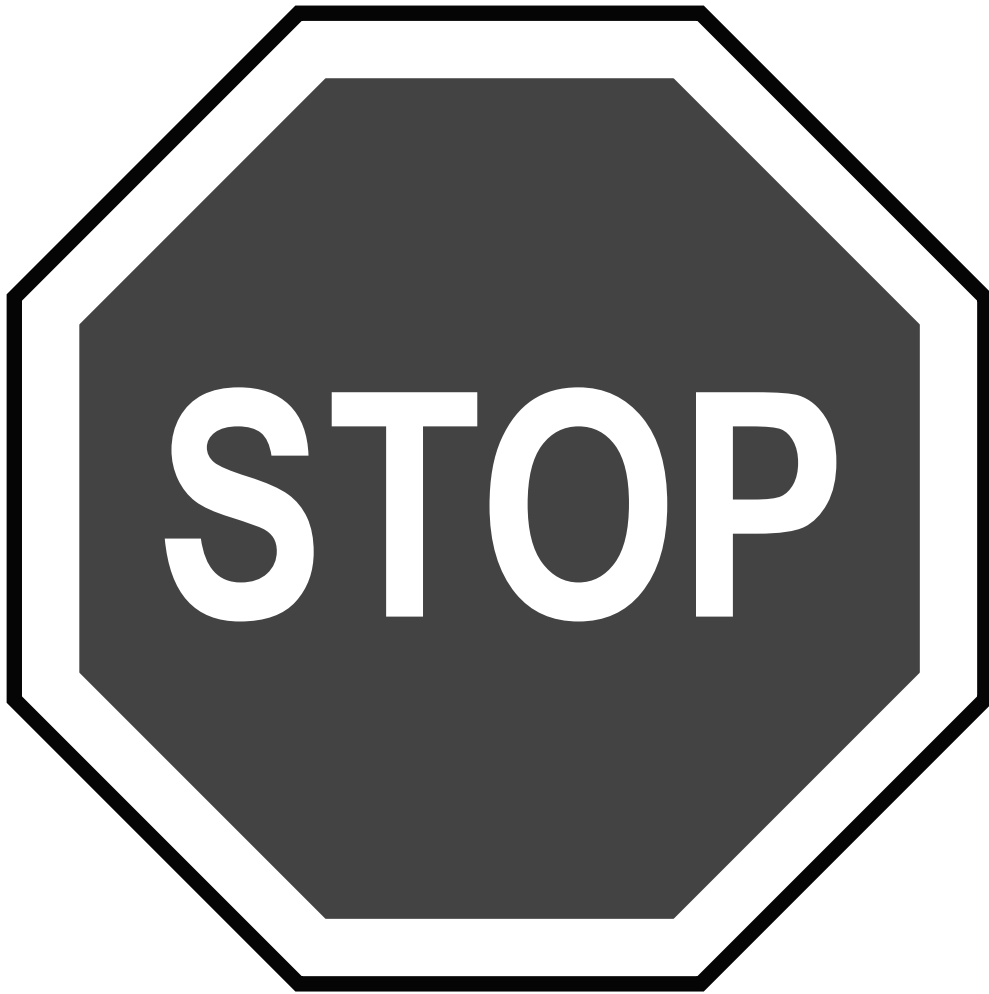

**BEFORE CONTINUING WITH THIS INSTRUCTION MANUAL OR ASSEMBLY OF YOUR AIRCRAFT, PLEASE VISIT OUR WIKI PAGE SUPPORT SITE FOR THE LATEST PRODUCT UPDATES, FEATURE CHANGES, MANUAL ADDENDUMS, AND FIRMWARE CHANGES FOR BOTH YOUR AIRCRAFT AND THE INSTALLED AURA 8 ADVANCED FLIGHT CONTROL SYSTEM.**

**[wiki.flexinnovations.com/wiki/F100D](http://wiki.flexinnovations.com/wiki/F100D)**

**[wiki.flexinnovations.com/wiki/Aura](http://wiki.flexinnovations.com/wiki/Aura)**

# TABLE OF CONTENTS

---

Introduction.....	2	Fin and Rudder Installation.....	13,14
Specifications.....	3	Main Wing Installation.....	15,16
Replacement Parts Listing.....	3	Drop Tank assembly and Installation.....	17
Optional Completion Items.....	3	Installation of Pitot Tube and Refueling Probe.....	18
Completion Items.....	3	C.G. and Elevator Trim Settings.....	19
Battery Charging Guidelines.....	3	Control Surface Recommended Throws.....	20
Special Language Definitions.....	4	Control Direction Test.....	21
Important Information Regarding Warranty.....	4	Flight Control Sensing Direction Test.....	22
Safety Warnings and Precautions.....	4	Preflight Checklist.....	23
Low Voltage.....	4	Flying your F-100D Super Sabre.....	24
Aura 8 AFCS.....	5	Expert Mode.....	25
Transmitter Setup.....	6	Troubleshooting Guide.....	26
Receiver Installation/Servo Connections.....	7,8	Airplane Repairs and Replacing Servos.....	27
Retract and Gear Sequencer Operation.....	9	Servicing the Power System.....	28
Elevator Installation.....	10,11	Limited Warranty.....	29
Elevator Linkage Installation.....	12	AMA Safty Code.....	30

---

## INTRODUCTION

Uncompromised, Scale EDF Performance!

The Iconic F-100D is the first of the USAF's legendary "Century Series" fighters that ushered in the era of supersonic military aircraft. The F-100D also known as "the Hun" served in a variety of roles including air-to-air fighter, attack fighter, and also served on several demonstration teams.

Designed by multi-time Top Gun Champion David Ribbe, the model F-100D is brought to life in a convenient, yet uncompromised package. David spent countless hours on every detail, from the complicated aerodynamics of the intake and tail pipe, to the smallest of scale markings, not only to provide scale realism, but also incredible flight performance.

With two color scheme options available, you can emulate your favorite Thunderbird, or take your camouflaged F-100D back to that bombing mission in Vietnam. Both trim scheme variants include premium water slide decals so you can customize your F-100D with various squadron variants or select your favorite Thunderbird to represent. All other common decals come applied at the factory.

The Aura 8 Advanced Flight Control System comes programmed and installed in the F-100D, making setup a breeze. This highly-refined 3-axis gyro makes the F-100D fly like it is a larger aircraft and in less wind. Thanks to the Aura's advanced implementation, it not only enhances the flying experience, but never interferes with pilot's control.

These features combine to offer a jet that carries energy, flies big, and performs more like a large turbine jet than a typical foam EDF. Want a scale EDF like no other? The Flex Innovations F-100D is the ticket to uncompromised scale EDF performance.

### INCLUDES

- F-100D assembled airframe painted with major decals applied
- Aura 8 Advanced Flight Control System (programmed and ready to use)
- 11 Blade 90 mm Ducted Fan
- Potenza 65BLDF 1600kv Motor
- Electric Retracts, Metal Struts, and Door Sequencer
- (7) Potenza DS15 Digital Servos on Flight Controls
- (2) Potenza DS12 Digital Servos on L.G. Door and Steering
- 100A V-Good® ESC with 8A SBEC

### REQUIRES

- 7+ Channel Transmitter
- 6S 4000-6200 40C (or higher) LiPo Battery
- 5+ Channel Receiver with Digital Output

## SPECIFICATIONS

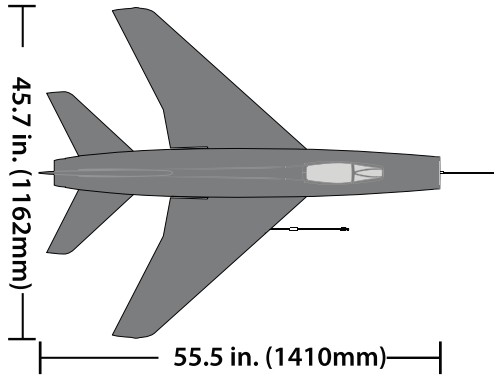

7lb 13oz(2930g)  
RTF with 6S 5200mAh  
battery installed











## REPLACEMENT PARTS

M407001	F-100D: Fuselage No Hatches Silver
M407002	F-100D: Fuselage No Hatches Green
M407003	F-100D: L/R Wing Set for Silver
M407004	F-100D: L/R Wing Set for Green
M407005	F-100D: L/R Stab and Fin Set for Silver
M407006	F-100D: L/R Stab and Fin Set for Green
M407007	F-100D: Canopy and Fan Hatches Green
M407008	F-100D: Canopy and Fan Hatches Silver
M407009	F-100D: Drop Tank Set Silver
M407010	F-100D: Drop Tank Set Green
M407011	F-100D: Wing/Fin Joiner CF Tube Set
M407012	F-100D: Silver Thunderbird Decal Set
M407013	F-100D: Green Vietnam Decal Set
M407014	F-100D: Tail Cone/Tail Pipe
M407015	F-100D: Pushrod Set
M407016	F-100D: Hardware Package
M407017	F-100D: Landing Gear Struts
M407018	F-100D: Nose Door/Hinges/Plastics Silver
M407019	F-100D: 4pc Bomb/Pylon Set Green
M407020	F-100D: 4pc Wheel Set
M407021	F-100D: Pitot,Probe, Wing Fences Silver
M407022	F-100D: Pitot,Probe,Wing Fences Green
M407023	F-100D: Nose Door/Hinges/Plastics Green
ZAURA08F100	Aura 8 with F-100D ID
ZA1038	1pc Steerable Nose Mini Retract
ZM1065DFC	Potenza 6S DF 1600 Kv BL Motor
ZESC6S100BEC	V-Good 100A ESC w/8A SBEC
FPMDF90A	90mm EDF Fan Assembly (No Motor)
ZA1021	RETRACT/DOOR SEQUENCER
ZA1020S	ELECTRIC RETRACT (1PC Main)
ZDS15B	Potenza DS15 MG Digital Servo w/165mm
ZDS15C	Potenza DS15 MG Digital Servo w/280mm
ZDS15D	Potenza DS15 MG Digital Servo w/395mm
ZDS12	Potenza DS12 MG Digital Servo w/165mm
ZDS12R	Potenza DS12 MG Digital Servo w/165mm (Reversed)

## OPTIONAL ACCESSORIES

PZA1010	Potenza Digital Battery Analyzer
ZB62006S40	Potenza 6S 6200mAh 40C Li-Po
ZB52006S40	Potenza 6S 5200mAh 40C Li-Po
ZB42006S75	Potenza 6S 4200mAh 75C Li-Po
ZB52006S75	Potenza 6S 5200mAh 75C Li-Po
MAR8010T	Spektrum R7008SB Receiver
FUTR7008SB	R7008SB S.BUS FASSTest
FUTT6K	Futaba T6K Transmitter w/R3006SB Rx
IDSTD2	iDST D2 Smart AC Dual Battery Charger 100W x 2 6s
IDST8	ISDT T8 Charger
ZA1027	ISDT Charge Lead Adapter

## COMPLETION ITEMS

INSTALLED!		11 Blade 90mm Ducted Fan w/ Potenza 65DF 1600 Kv BL Motor (FPMDF90A) (FPZM1065DFC)
INSTALLED!		V-Good® 100A ESC with 8A SBEC (FPZESC6S100BEC)
INSTALLED!		Potenza DS15 (7) and DS12 (2) Digital Servos (FPZDS15) (FPZDS12)
INSTALLED!		Aura 8 Advanced Flight Control Sys (FPZAURA08F100)
INSTALLED!		Electric Retracts, Metal Struts, and Door Sequencer
NEEDED TO COMPLETE		4000-6200mAh 6S 22.2v 40C or higher LiPo Battery (FPZB62006S40)
NEEDED TO COMPLETE		7-Channel Computer Transmitter*
NEEDED TO COMPLETE		SRXL/S.Bus Futaba/Graupner SumD/ JR XBus/ Jeti Ex Bus 5+ Channel RX with Digital Data Output

## BATTERY CHARGING GUIDELINES

### ⚠ WARNING

FOLLOW ALL INSTRUCTIONS PROVIDED BY YOUR BATTERY AND CHARGER MANUFACTURER. FAILURE TO COMPLY CAN RESULT IN FIRE.

The assembly of the F-100D Super Sabre can be accomplished in less than one hour. Prior to assembling the airplane, it is advisable to charge battery so that you are ready to begin setup upon completion of the assembly of your model.

We recommend the use of an advanced LiPo balancing charger for batteries to get the maximum performance and lifespan from them.

Our airplanes are designed around our Potenza LiPo batteries and we recommend the Potenza 6S 6200 LiPo (FPZB62006S40) in the F-100D Super Sabre based on our extensive testing and developme This battery features an EC5 connector, no soldering is required for use in your F-100D Super Sabre.

All are available online at [www.flexinnovations.com](http://www.flexinnovations.com) and your local Flex Innovations retailer.

## SPECIAL LANGUAGE DEFINITIONS

The following terms are used throughout the product literature to indicate various levels of potential harm when operating this product:

- NOTICE:** Procedures, which if not properly followed, create a possibility of physical property damage AND a little or no possibility of injury.
- CAUTION:** Procedures, which if not properly followed, create the probability of physical property damage AND a possibility of serious injury.
- WARNING:** Procedures, which if not properly followed, create the probability of property damage, collateral damage, and serious injury OR create a high probability of serious injury.

### WARNING

## AGES 14+

This product is not intended for use by children under 14 years without direct adult supervision.

### ATTENTION

Read the ENTIRE instruction manual to become familiar with the features of the product before operating. Failure to assemble or operate the product correctly can result in damage to the product, personal property, and cause serious or fatal injury.

All instructions, warranties and other collateral documents are subject to change at the sole discretion of Flex Innovations LLC, Inc. For up-to-date product literature, please visit our website at [www.flexinnovations.com](http://www.flexinnovations.com) and click on the F-100D and Aura 8 product pages

## IMPORTANT INFORMATION REGARDING WARRANTY

Please read our Warranty and Liability Limitations section before building this product. If you as the Purchaser or user are not prepared to accept the liability associated with the use of this Product, you are advised to return this Product immediately in new and unused condition to the place of purchase.

## SAFETY WARNINGS AND PRECAUTIONS

Protect yourself and others by following these basic safety guidelines.

1. This manual contains instructions for safety, operation and maintenance. It is essential to read and follow all the instructions and warnings in the manual, prior to assembly, setup or use, in order to operate correctly and avoid damage or serious injury.
2. This model is not a toy, rather it is a sophisticated hobby product and must be operated with caution and common sense. This product requires some basic mechanical ability. Failure to operate this product in a safe and responsible manner could result in injury or damage to the product or other property.
3. This model must be assembled according to these instructions. Do not alter or modify the model outside of these instructions provided by Flex Innovations, LLC, as doing so may render it unsafe and/or unflyable. It is your responsibility to ensure the airworthiness of the model.
4. Inspect and check operation of the model and all its components before every flight.
5. If you are not an experienced pilot or have not flown a high-performance model before, it is recommended that you seek assistance from an experienced pilot in your R/C club for your first flights. If you're not a member of a club, the Academy of Model Aeronautics (AMA) has information about clubs in your area whose membership includes experienced pilots.
6. Never fly in visible moisture or submerge the airplane or any of its electronic components in water. Permanent damage to electronic components may occur, or corrosion of components may lead to intermittent failures.

## LOW VOLTAGE CUTOFF

LiPo batteries have a nominal (rated) voltage of 3.7v per cell, and fully charged, reach 4.2v per cell. Batteries are designed to be discharged below the nominal voltage. However, if they are discharged below 3.0v per cell, damage will occur and the pack will lose capacity. For best long term battery life, set a timer and land after a time that leaves approximately 15% of the battery's capacity remaining.

Low voltage cutoff is a feature that is built into the V-Good 100A ESC w/8A SBEC that is designed to protect the connected battery from being discharged too far and causing permanent damage to the cells. Circuitry within the ESC will automatically detect when the input voltage from the battery pack reaches below 3.15v per cell (average) and will remove power to the motor, but still deliver power to the servos so that a safe landing may be made. If the motor begins to lose power rapidly during flight, the LVC has sensed that the total voltage of the pack has dropped below 3.15v per cell average, and the airplane should be landed immediately.

## AURA 8 AFCS

The Aura 8 Advanced Flight Control System (AFCS) installed in your F-100D is a giant leap forward in aircraft flight control system technology. Compatible with virtually every digital output capable receiver on the market today, the Aura features a serial data connection for Futaba or Hitec S.Bus, Spektrum SRXL, Graupner HOTT (Sum D of 8), JR XBus (Mode B), and Jeti (ExBus) systems.

The Aura 8 advanced flight control system installed in your aircraft has been pre-tuned for ease of use, eliminating many hours of tedious setup. For the latest Aura features, programs, transmitter downloads, and instructions, please visit [wiki.flexinnovations.com/wiki/Aura](http://wiki.flexinnovations.com/wiki/Aura)

The Aura is programmable through any Windows based PC or tablet via the Aura Config Tool. All dual rate, expo, travel and assignable mode programs are adjusted inside the Aura through the PC application. An assignable master gain that is OFF by default can be enabled by the Aura application. If desired, assign CH8/AUX 3 on a proportional dial or slider.

**By default, CH7/Aux2 is used to select the 3 flight modes by 3 position transmitter switch.** CH6 is used to deploy the Flaps, and CH5/Gear is used to retract/deploy the landing gear.

- Works conveniently with all major radio systems
- Accepts signals from Spektrum SRXL, Futaba S.Bus, Graupner Hott (Sum D of 8), JR XBus (Mode B), Jeti (Ex Bus), Hitec S.Bus, PPM Stream
- Expertly tuned and ready to use
- USB port allows loading model configurations, user programming, and firmware updates (cable included)
- Flexible and extensive programming through Windows-based PC or tablet
- 3+ flight modes allow precise or aggressive settings to be selected in flight
- 3-axis gyro utilized in F-100 programming

**Visit [wiki.flexinnovations.com/wiki/Aura](http://wiki.flexinnovations.com/wiki/Aura) for the latest Aura-related product information and tips for your particular radio brand.**

### Description of Pre-Loaded Aura Flight Modes (FM)

#### Mode 1 (Gyro Off):

Gyro gain is set to 0 (off). All rates are set to low for general flight. Exponential is tuned for comfortable flight.

#### Mode 2 (Low Rate):

Gyro gains are moderate and tuned for comfortable feel/best performance for general flight. All rates are set to low for general flight. Exponential is tuned for comfortable flight.

#### Mode 3 (High Rate Sport/Advanced Mode):

Gyro gains are highest and tuned for general flight. Rates are highest and exponential is tuned for comfortable flight

Each of the modes are tuned by the Flex team to offer a solid start. Individual preference in control feel can vary, so sometimes changes of rates and expo are required to better suit individual pilots. Adjustments should be made through the **Aura 8, via Aura Config Tool NOT in the transmitter.** Changes in gain value can only be made through the Aura or via **master gain** (if activated).

**To download the Aura Config Tool, please visit:  
<https://www.flexinnovations.com/aura-config-tool-install/>**



## TRANSMITTER SETUP

Start with a freshly reset, new model memory in your transmitter. Make ONLY the changes shown in the Transmitter Configuration Guide.

The Aura 8 in your aircraft defaults to 3 flight modes that are switched via CH7/Aux2 in your transmitter. You may need to reassign CH7/Aux2 to a 3-position switch.

**Consult your transmitter manual if you have questions on how to change the switch or channel assignments.**

The Aura comes pre-programmed with dual rates and expos specifically designed for your aircraft. For large (greater than 5%) changes in expo or dual rates, it is highly recommended to reset all expos and rates to default in the transmitter, and tune through the Aura Config Tool.

**The Aura Config Tool is free to download, and can be used on any Windows-based PC or tablet. Download at:**

**<https://www.flexinnovations.com/aura-config-tool-install/>**

More information for specific transmitter brands available here: [http://wiki.flexinnovations.com/wiki/Aura#Aura\\_Tips](http://wiki.flexinnovations.com/wiki/Aura#Aura_Tips)

### TRANSMITTER CONFIGURATION GUIDE

	Spektrum, Futaba, & Graupner	FrSky
Wing/Tail Type	1 Aileron, 1 Elevator, 1 Rudder, 1 Flap	1 Aileron, 1 Elevator, 1 Rudder, 1 Flap
End Points (Travel EPA or ATV)	Ail/Ele/Rud/Gear/CH5 <b>125%</b>	Ail/Ele/Rud/CH5 <b>100%</b>
	CH6/Aux1 CH7/Aux2 <b>100%</b>	CH6/CH7 <b>84%</b>
Reversing	Ail/Ele/Rudder set to Normal Throttle depends on receiver connection type <sup>2</sup>	Ail/Ele/Rudder set to Normal Throttle depends on receiver connection type <sup>2</sup>
Sub Trim	Verify at zero, NOT ALLOWED	Verify at zero, NOT ALLOWED
Trim Levers	Verify at zero	Verify at zero
CH5 (Gear)	Assigned to a 2-position switch (retracts)	Assigned to a 2-position switch (retracts)
CH6 (Flaps)	Assigned to a 3-position switch (Flaps) (Use Flap/land system with 1 Flap if available)	Assigned to a 3-position switch (Flaps) (Use Flap/land system with 1 Flap if available)
CH7 (Aura Flt. Modes)	Assigned to a 3-position switch (Aura Flight Modes)	Assigned to a 3-position switch (Aura Flight Modes)
Timer <sup>4</sup>	Set to 2:45 for initial flights	Set to 2:45 for initial flights

1. Note: JR Mode B users refer to the F-100D Wiki page.
2. Throttle direction depends on transmitter brand and receiver connection type. Leave at defaults to start, and reverse as needed.
3. The F-100D Super Sabre can fly anywhere between 3 and 4.5 minutes depending on flying style and condition of battery.

## NOTICE

**FOR CUSTOMERS USING TRANSMITTERS OTHER THAN WHAT IS LISTED IN THE CHART ABOVE, PLEASE VISIT OUR WIKI PAGE FOR INSTRUCTIONS SPECIFIC TO YOUR TRANSMITTER AND RECEIVER BRAND**

JETI	<a href="http://wiki.flexinnovations.com/wiki/Aura/JetiUse">wiki.flexinnovations.com/wiki/Aura/JetiUse</a>
HITEC	<a href="http://wiki.flexinnovations.com/wiki/Aura/HitecSbusUse">wiki.flexinnovations.com/wiki/Aura/HitecSbusUse</a>
JR	JR Mode B users refer to the F-100D Wiki page <a href="http://wiki.flexinnovations.com/wiki/F100D">wiki.flexinnovations.com/wiki/F100D</a>

# RECEIVER INSTALLATION/SERVO CONNECTIONS

Aura will auto-detect modern digital receiver connection(s). Using a modern digital receiver connection gives the Aura access to precise data of each channel for additional gyro-enabled outputs, simplifies wiring and allows for more advanced features.

## DEFAULT AURA CONNECTIONS

- S1** Left Aileron
- S2** Right Aileron
- S3** Left Elevator
- S4** Right Elevator
- S5** Rudder
- S6** Nose Wheel
- S7** Left Flap
- S8** Right Flap

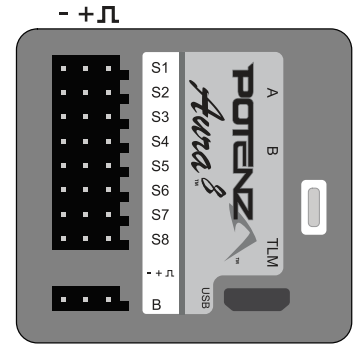

## Supported Modern Data-linked Receivers

Aura will auto-detect these modern digital receiver connections:

- |                                |                  |
|--------------------------------|------------------|
| Futaba, FrSky, or Hitec S. Bus | Spektrum SRXL    |
| Graupner HOTT (Sum D of 8)     | JR XBus (Mode B) |
|                                | Jeti (standard)  |

A PPM (8CH, negative shift, approximately 22ms/frame) receiver may also be connected into port "B"; however, Aura will not auto-detect and setup must be performed through the Aura Config Tool (Windows Application)

For specific information on receiver types and our recommended receivers for this aircraft, please visit the F-100D Wiki page at the below URL.

[wiki.flexinnovations.com/wiki/F100D](http://wiki.flexinnovations.com/wiki/F100D)

# CONNECTING YOUR RECEIVER TO AURA

## Digital receiver connections

Examples of recommended receivers:

### Spektrum SRXL

- AR8010T
- AR9030T

### Futaba S.Bus

- T-FHSS - R3006SB
- FASSTest - R7008SB

### JR XBus

- RG612BX
- RG712BX

### Graupner SUMD

- GR-16L

### FrSky S.Bus

- RX6R
- RX8R

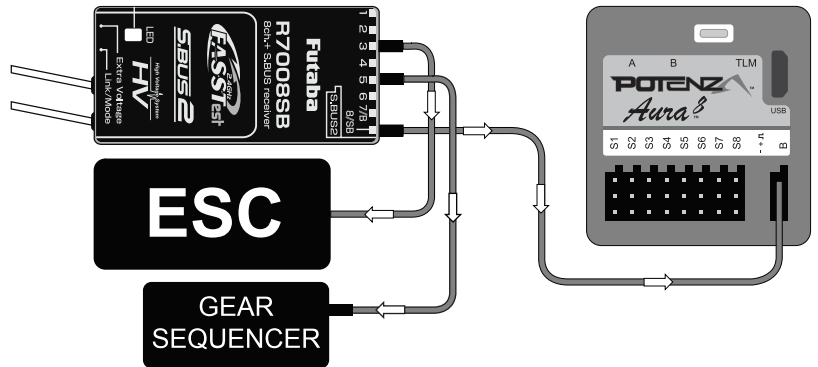

1. While Spektrum and Futaba usually output their digital data stream, it may be necessary for JR DMSS, Graupner HOTT, and Jeti users to program the transmitter/receiver to output the correct digital format listed on the previous page. Consult your transmitter and receiver manuals for further details.
2. Bind your transmitter and receiver per your manufacturer's instructions.
3. Connect the included male to male servo extension to the receiver's serial port (ex: S.Bus, SRXL, etc.) and connect to servo port "B" on the face of the Aura. Refer to your radio manufacturer's instructions for specific information on appropriate serial port connections and system settings.
4. With the transmitter powered, power up the aircraft. Aura will search (sweeping LEDs) and lock onto the signal. You will then see solid orange (power and calibrated sensor) plus solid green (valid radio source), and have control of the model.

Note: If you are using Futaba S.Bus, be sure to use the proper S.Bus port in your receiver. DO NOT use the S.Bus 2 port, as it is not supported for use with the Aura 8. Refer to your manufacturer's instructions for proper S.Bus use.

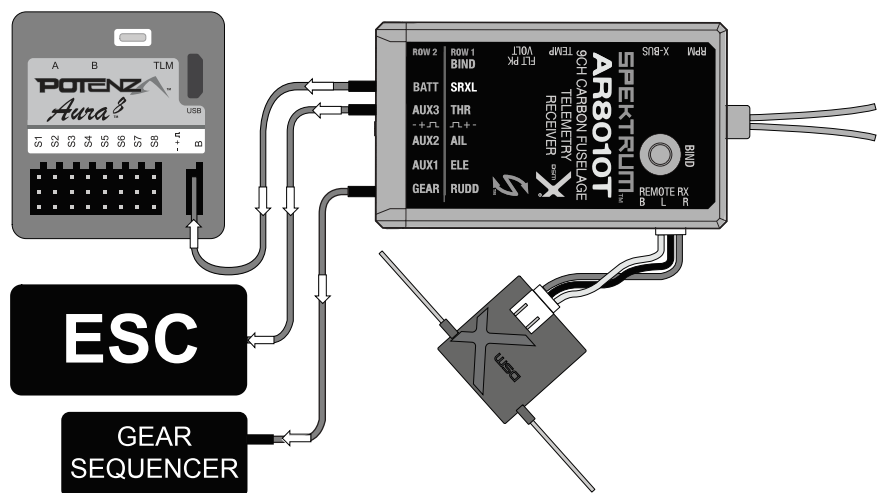

Note: When using Spektrum SRXL to connect to the Aura, always connect the remote receivers to the Spektrum receiver NOT the Aura.



## RECEIVER INSTALLATION/SERVO CONNECTIONS (CONTINUED)

### NOTICE

Using Only Spektrum Remote Receivers (1 or 2) is not supported for the the F-100D Super Sabre. A Receiver with Modern Digital Connection AND working servo ports is the preferred receiver connection method for the F-100D Super Sabre

### NOTICE

Due to the servo port requirements, PWM is NOT SUPPORTED for the F-100D Super Sabre. PPM users should consult the Wiki Page [wiki.flexinnovations.com/F-100D](http://wiki.flexinnovations.com/F-100D)

## CONNECTING A BATTERY/ARMING THE ESC

Observe the following procedures to safely power up your model after it has been bound.

1. Lower the throttle stick and trim to their lowest setting and turn on the transmitter. Wait for your transmitter to indicate the radio signal is being broadcast before proceeding.

If a battery is connected to the ESC with the throttle fully open on the active transmitter, the ESC will enter programming mode. If this occurs, simply disconnect the battery, lower the throttle, and reconnect the battery.

2. Ensure the aileron, elevator and rudder gimbals are centered.
3. With the airplane on a solid surface, connect the battery to the ESC and wait. The ESC will make the motor emit a series of audible tones during its intialization process.
4. The ESC will make the motor emit a short, final tone sequence idicating that the ESC is now armed, and that the motor will spin in response to throttle stick movement.

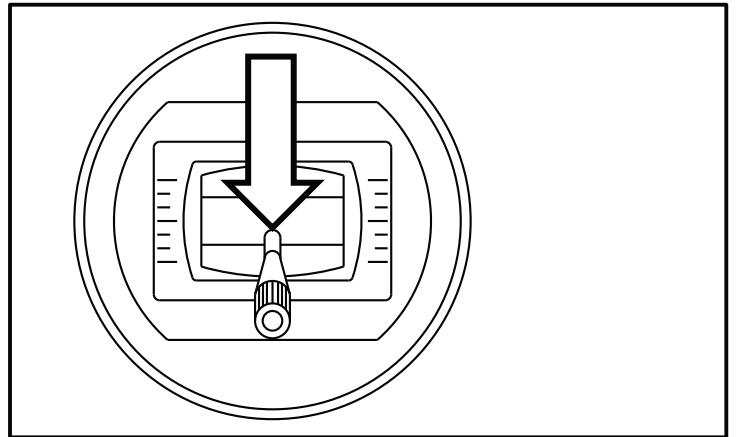

### CAUTION

**Always connect the battery when the throttle stick and throttle trim is in the idle/cut-off position.**

## RETRACTS AND GEAR SEQUENCER OPERATION

---

**The following steps will be required EACH time the aircraft is powered for flight:**

1. Ensure your radio has CH5 (Gear) assigned to a 2-position switch and is set to 125% travel.
2. Hold the F-100D Super Sabre in a manner that the gear doors and retracts are unobstructed and free to close and open.
3. To arm the retracts, cycle your transmitter's CH5/Gear switch from **down to up, then down again waiting about 1 second in each position.**
4. Test the retracts. Ensure the gear/door opens and closes without binding or stalling the servos. Adjust ball link as necessary for the door to function properly. When satisfied with the result, power off the aircraft.

### **NOTICE**

**The nose gear door should come set up from the factory. However, it is a good idea to double check the function and verify the servo is not binding when closed. Adjust the ball link on the door by threading in or out as necessary.**

Please note, CH5/Gear can be reversed in the transmitter for user preference.

## ELEVATOR INSTALLATION

---

### Required Tools, Parts, and Fasteners

1.5mm Hex Wrench  
#2 Phillips Screwdriver  
Blue Thread Lock

1. Locate the fuselage, elevators, 2 included wheel collars, blue thread lock, and a #2 Phillips screwdriver.
2. Secure the fuselage inverted on stand or use and soft blanket/towel to protect the top of the fuselage.
3. Using the #2 Phillips screwdriver, remove the cover plate on the bottom of the fuselage.



4. Using blue thread lock, apply a small amount to the threads of the set screw. (Notice the flat area on end of the elevator pivot tube for proper set screw location)

NOTE: Never let thread lock touch plastic parts, use on metal to metal fasteners only.

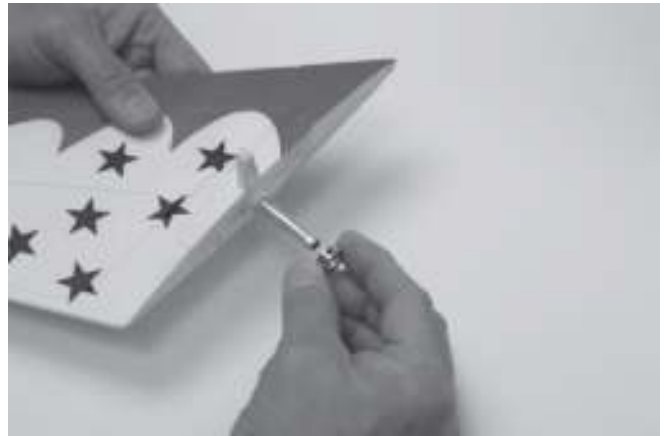

## ELEVATOR INSTALLATION (continued)

---

5. Slide the elevator pivot tube through both sets of bearings just until the end of the tube is flush with the outside face of the bearing . While holding the elevator in one hand, carefully slide the wheel collar down into the slot until you feel it catch the end of the elevator pivot shaft. (you might have to wiggle the elevator slightly while gently pushing inboard on it to “catch” the bearing)
6. Using a 1.5mm Hex wrench, tighten the set screws in the wheel collars to secure the elevators to the fuselage.

### NOTICE

**To ensure proper elevator operation, be sure the elevator moves freely after installation.  
Failing to skip this step could result in servo failure or crash and loss of the airplane.**

6. Reinstall the cover plate on bottom of fuselage using the two M3x10 self-tapping screws and a #1 Phillips screwdriver.



# ELEVATOR LINKAGE INSTALLATION

## Required Tools and Fasteners

#1 Phillips Screwdriver

1. Power on the transmitter, ensure the servo arms are perpendicular to the case of the servo and pointing away from the center of the fuselage.
2. Install the ball link to the elevator control horn using a #1 Phillips head screwdriver while holding the nut with your finger to prevent it from falling out as you start to tighten the screw. Install the forward ball link on the servo arm with the lock nut on the top in the second hole out from the inside of the servo arm (see diagram below).

Note: Do not use Thread Locker for these connections as they use locking nuts.

3. Install servo arm mounting screw with the technique noted below.

Note the proper use of thread locker when attaching a plastic servo arm to a servo with a metal output gear and metal center screw:

- a. Place the servo arm on the output shaft with proper orientation.
- b. Put a small drop of thread lock onto a piece of scrap paper.
- c. Roll the end of the screw into the thread locker, then blot away any excess thread locker from the end and the side of the screw leaving the thread lock only inside the screw threads.
- d. Carefully install and snug the screw. This will let the thread lock secure the metal to metal joint, while keeping it off of the plastic which is damaged by thread locker.

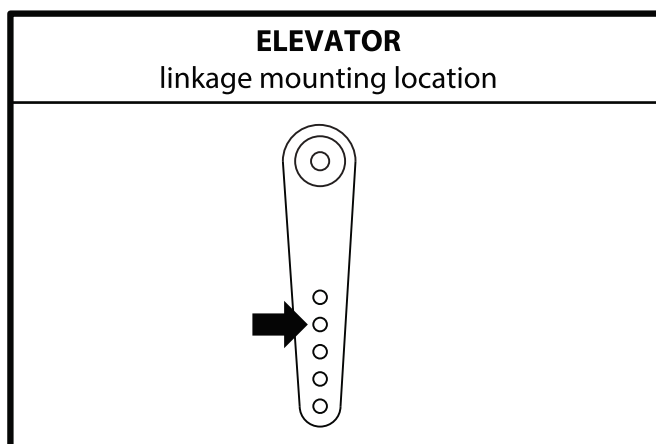

## FIN AND RUDDER INSTALLATION

---

### Required Tools and Fasteners



- #1 Phillips Screwdriver
- (2) M3x10 Phillips head self-tapping screws

1. Locate the vertical fin/rudder, short 1/4" dia. carbon tube and (2) M3x10 self-tapping Phillips head screws.
2. To mount the vertical fin/rudder assembly to fuselage, install the carbon tube into the plastic housing located on the top of the fuselage.
3. Connect the rudder servo lead.
4. Slide the vertical fin assembly into place over the carbon tube while making sure the servo lead isn't being pinched within the joint of the fin and fuselage.





## FIN AND RUDDER INSTALLATION (CONTINUED)

---

5. Now that the fin/rudder assembly is in place, secure it using the two M3x10 Phillips self-tapping screws in the front and rear of the fin/rudder assembly.
6. Be sure the rudder linkage is disconnected before connecting the battery. Confirm the servo arm is centered after connecting the battery, then re-install the rudder linkage.

Note: Do not use Thread Locker for this connection.

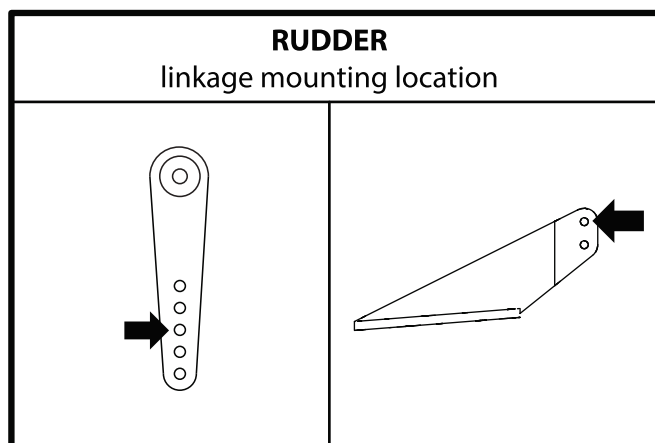

## MAIN WING INSTALLATION

---

### Required Tools and Fasteners



#2 Phillips Screwdriver  
(4) M3x10 Phillips head self-tapping screws  
5 Minute Epoxy  
Medium CA

1. Locate wings and wing fences. Using 5 minute epoxy, spread a small amount of glue into the wing fence mounting slot on the top of the wing. Install the wing fence. **Be aware there is a left and right wing fence and take note to ensure proper orientation prior to installation.** (See bottom picture to reference wing fence orientation)

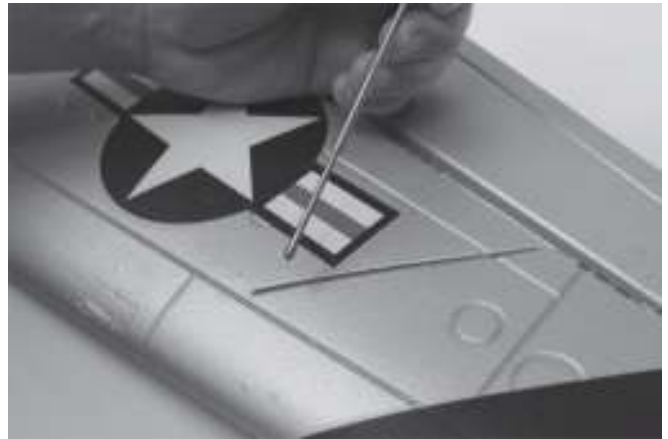

## MAIN WING INSTALLATION (CONTINUED)

2. Locate the wings, wing tubes, fuselage, and the (4) M3x10 Phillips head self-tapping screws
3. Slide the wing tubes into the wing panel then slide wing into place on the fuselage. Plug in the servo/LED/Gear connector as you install the wing onto the fuselage.
4. Once you have the wing firmly in place on the fuselage, install the (4) M3x10 Phillips head self-tapping screws to secure the wing to the fuselage.

Note: Do not use thread locker on this connection.

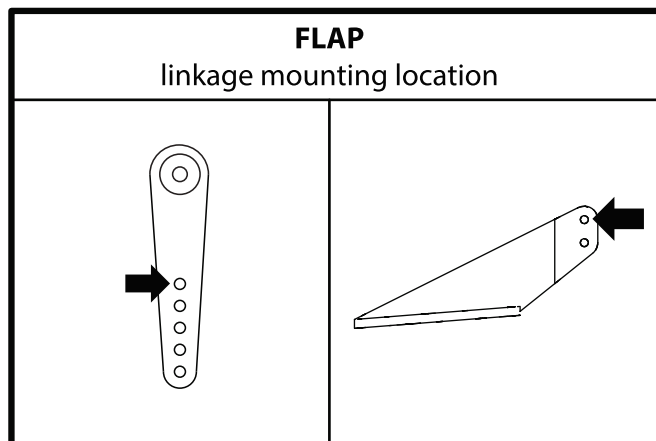
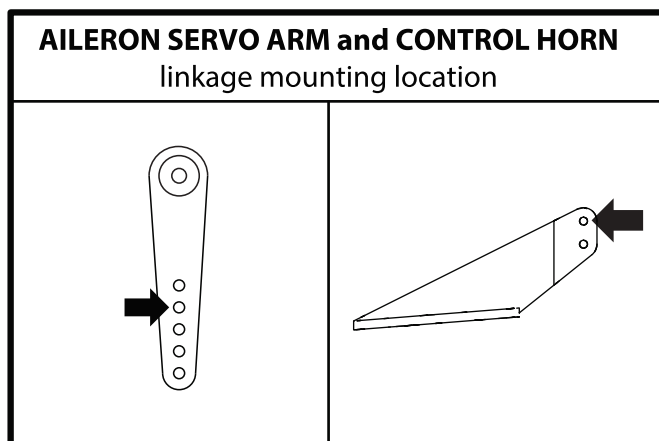

## DROP TANK ASSEMBLY AND INSTALLATION

1. Locate the drop tank bodies and fin sections. Apply medium CA to the joint where the bodies and fin sections come together.

Note: Use regular CA, "foam safe" is not necessary

### NOTICE

**Make sure to have the orientation of the fin section correct as the tanks are slightly arched and the fin sections only fit one way.**

2. Once the glue has cured, you can then install the tanks on the wings. Simply insert the tabs into the inboard slots located on the bottom of the wing and carefully pull the tank towards the trailing edge to lock into place.

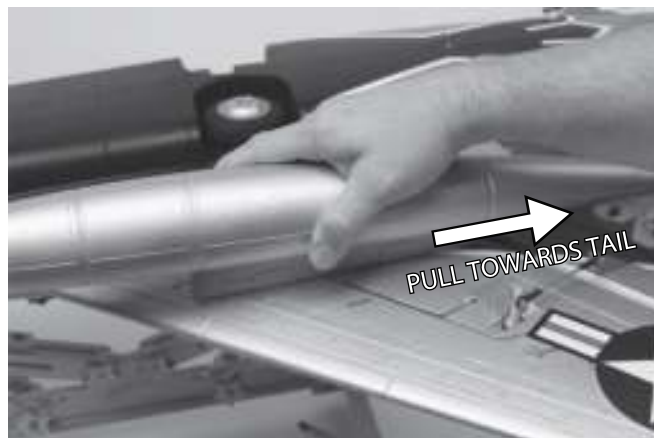
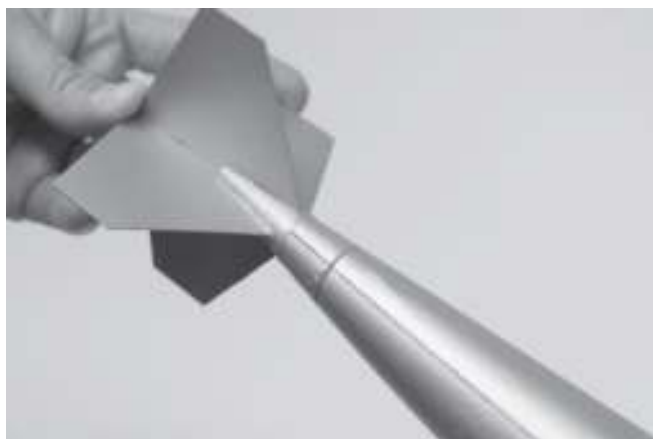
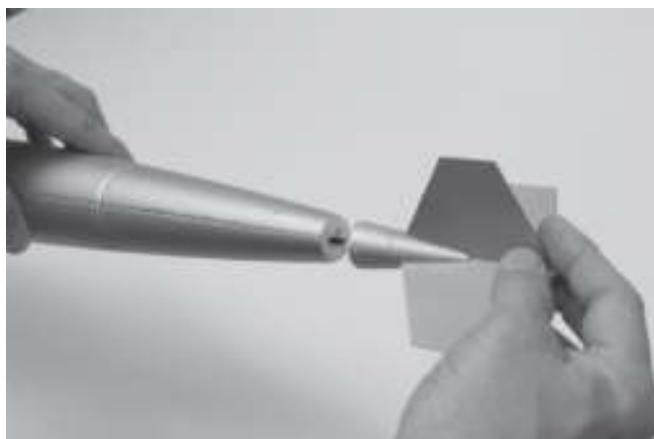

## INSTALLING PITOT TUBE AND REFUELING PROBE

---

1. Locate the supplied pitot tube and refueling probe and secure the airplane upside down on a stand or soft blanket.
2. Insert the tab into the slots located on the bottom of the nose and/or wing and carefully pull the pitot tube/refueling probe towards the rear of the airplane to lock it into place.



## BATTERY INSTALLATION

1. Remove the canopy from the fuselage by pulling the canopy latch toward the rear of the plane. While holding back on the latch gently lift the canopy off of the fuselage.
2. Apply a piece of hook-sided adhesive backed hook and loop strip on the battery tray.
3. Place the flight battery in the battery compartment and secure it with the hook and loop strap as shown in photos below.



## CENTER OF GRAVITY VERIFICATION

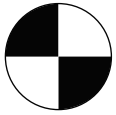

**8mm** AFT of Panel Line with no Drop Tanks.

**5mm** AFT of Panel Line with Drop Tanks installed.

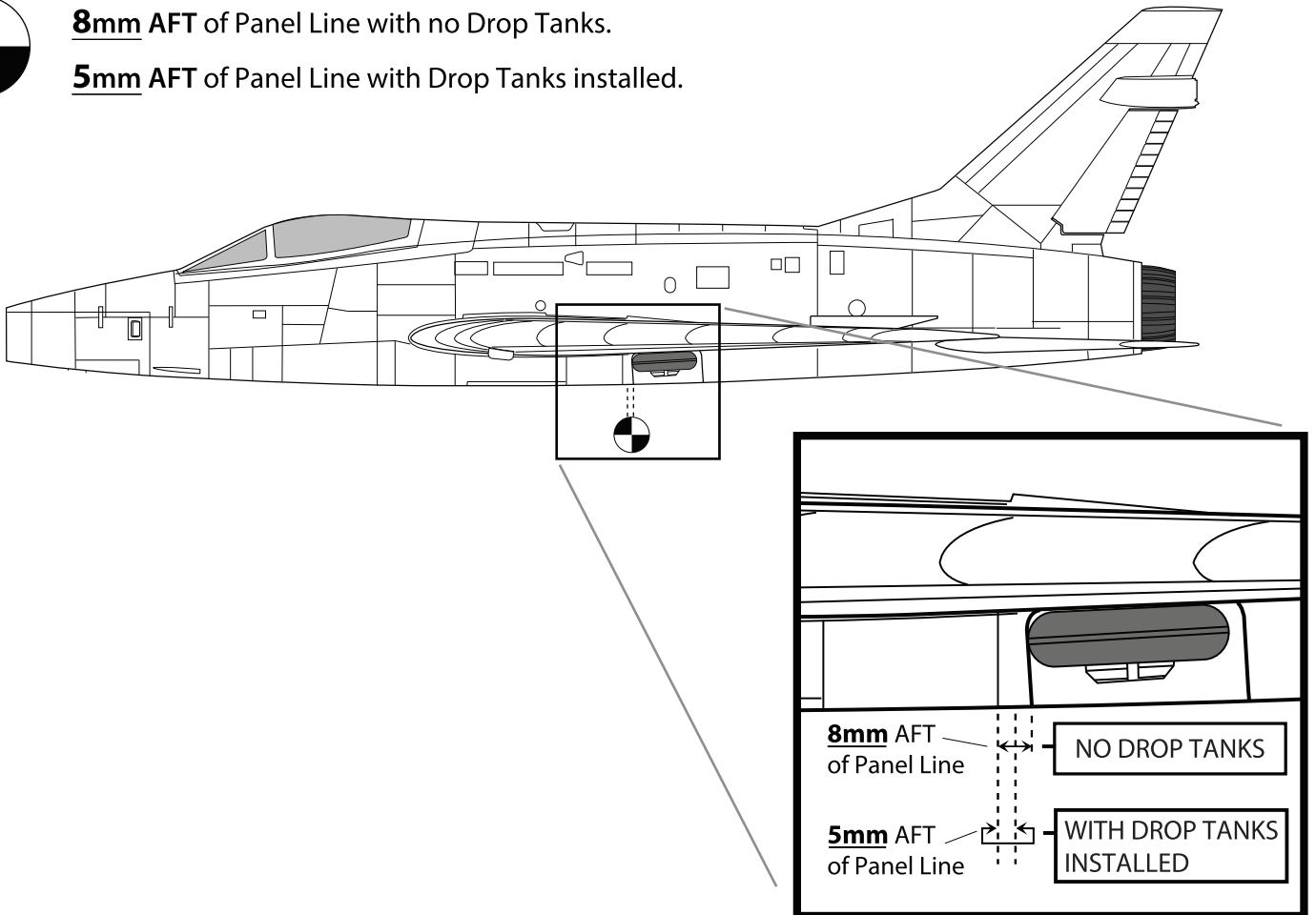



## ELEVATOR TRIM SETTINGS

The elevators require different trim settings depending on whether or not the drop tanks are installed.

NO DROP TANKS	DROP TANKS INSTALLED
26.5mm	23.5mm

Measure from the L.E. at the root of the elevator to the Panel Line just above the the elevator.



## RECOMMENDED FLAP TRAVEL FOR REFERENCE

Measurement Location		
Measured from the root or most central side of the flap at the trailing edge.	UP	0mm
	HALF	32mm
	FULL	50-64mm

**ELEVATOR compensates UP about 3% at Full Flap, About 1% at half Flap**

## CONTROL DIRECTION TEST

Refer to the chart below to determine the proper control surface directions.

If controls are reversed, DO NOT REVERSE CONTROLS IN TRANSMITTER OR IN THE AURA CONFIG TOOL. Email us at [support@flexinnovations.com](mailto:support@flexinnovations.com) for corrective action. Note that BOTH the Transmitter Control Direction Test AND the Flight Controller Sensor Direction Test **MUST BOTH BE PASSED! IF ONE DOES NOT PASS, DO NOT FLY!**

Note: There is "Taileron" mixing in all flight modes.

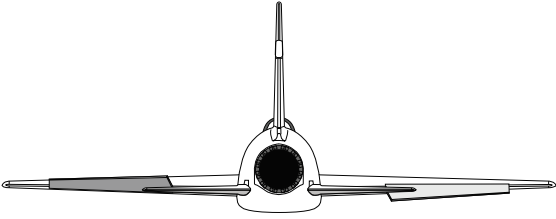
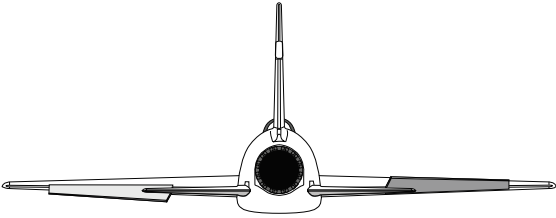
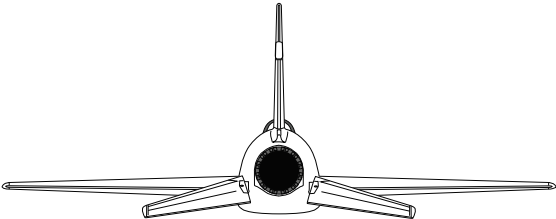
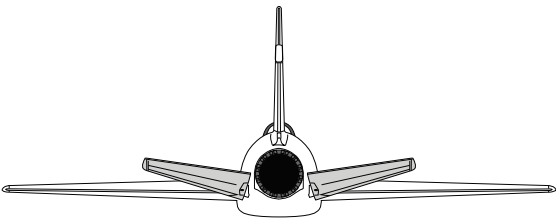
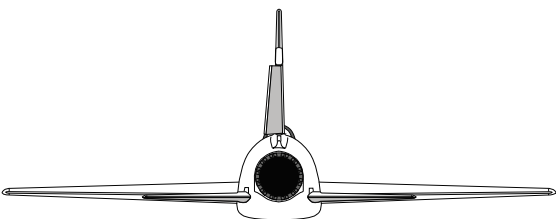
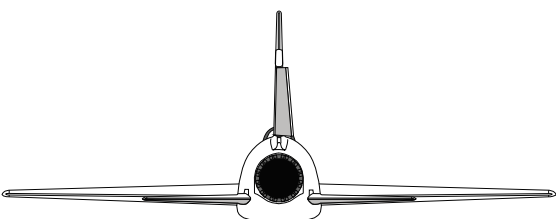
	Transmitter Command	Proper Control Surface Deflection
AILERON	Stick Left	
	Stick Right	
ELEVATOR	Stick Forward	
	Stick Aft	
RUDDER	Stick Left	
	Stick Right	

## FLIGHT CONTROL SENSING DIRECTION TEST

Perform a test of the gyro system to verify the corrections made for a given movement are correct. If any of the tests do not result in the correct reaction from the airplane's gyro system, **DO NOT FLY THE AIRPLANE, and contact us via email at support@flexinnovations.com**

The flight control system activates with RF broadcast. Perform these tests in Mode 3 (higher gain) for better visibility and then in Mode 2, and any other modes that have gyro gains assigned. (By default, Mode 1 has no gain assigned.) Control surface deflections are exaggerated in the drawings below for clarity. Please note, that the control surfaces will move **ONLY** when the aircraft is being **ROTATED**.

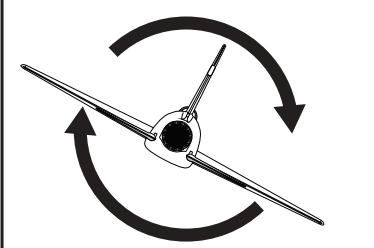
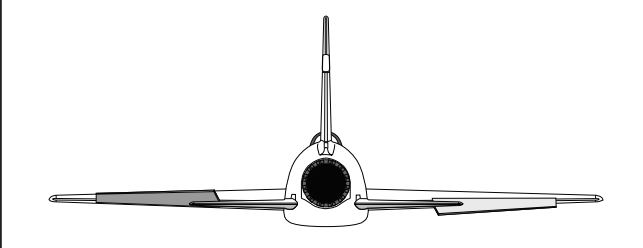
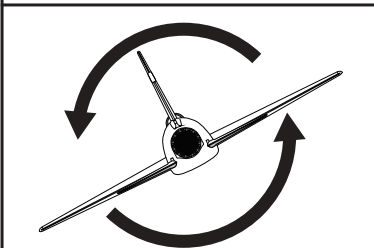
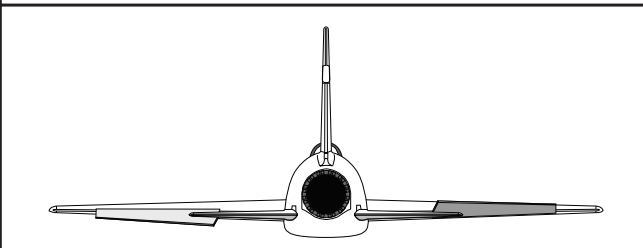
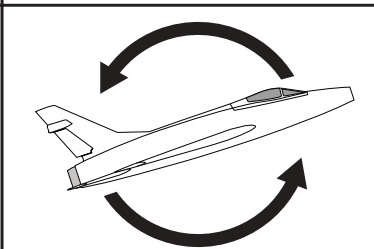
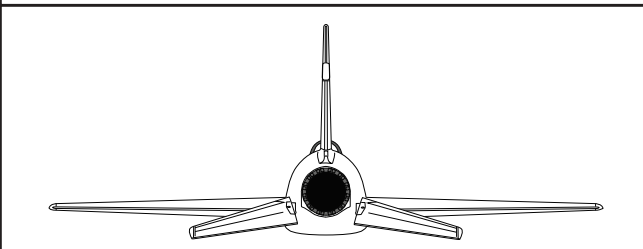
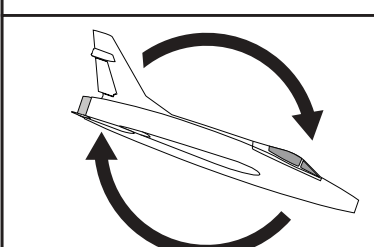
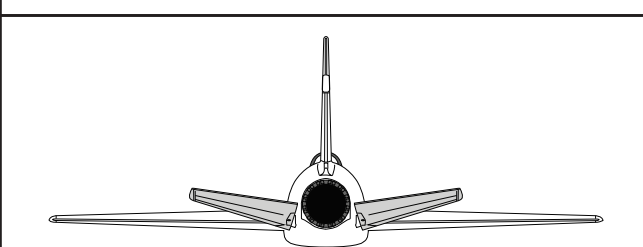
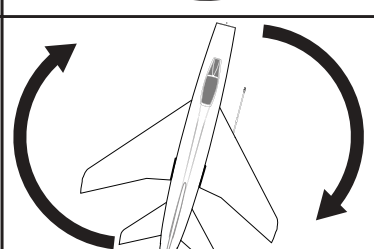
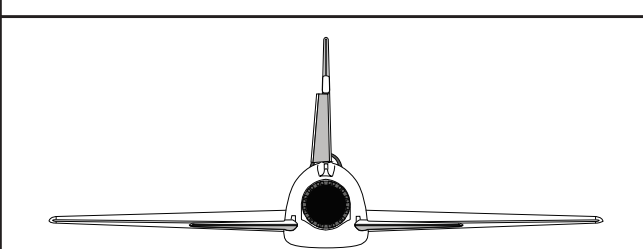
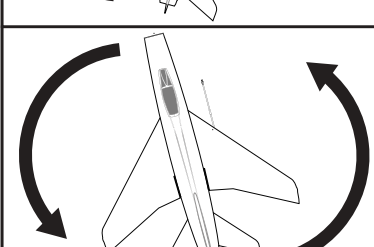
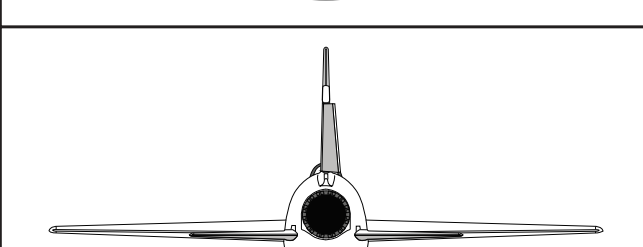
	Aircraft Movement	Proper Control Surface Deflection
AILERON		
		
ELEVATOR		
		
RUDDER		
		

## PRE-FLIGHT CHECKLIST

---

To help ensure a successful first flight, as well as many flights after, perform a few simple pre-flight checks to be sure the aircraft is ready to fly.

1. Verify all control surfaces are properly hinged and are in good working order. Pinch a control surface between your thumb and fore finger and stabilize the wing with your other hand. Give the control surface a good pull away from the wing. The control surface should not come unhinged from the wing. Be sure to avoid over-stressing the part as an aggressive pull may cause the control surface to come unhinged even though it was hinged properly. If hinging is loose, DO NOT FLY! Apply thin CA to the loose side(s) of the hinged to re-secure.
2. Verify that all hardware and other aircraft parts are properly secured, including those connections that require blue thread lock. This includes hardware and parts installed by the factory.
3. Verify your battery is fully charged and in good condition. Avoid using batteries with swollen cells, or batteries that do not charge back to their full capacity.
4. Verify the C.G. is in the proper location and the battery is secured in place.
5. Ensure the Aura is on and functioning properly. Power on your transmitter, followed by the aircraft. Ensure the Aura is calibrated properly and receiving a valid radio source (solid orange+solid green LEDs).
6. Verify transmitter stick inputs result in the proper control surface movements (reference page 22) and that Aura flight modes work properly.
7. Verify aircraft movement results in proper Aura sensor corrections (reference page 23).
8. Verify the motor and ESC function properly. Point the aircraft in a safe direction. Hold the airframe firmly, smoothly advance the throttle to full and back to idle. Listen and watch for any odd or unusual behavior for the motor or speed controller.

# FLYING YOUR F-100D SUPER SABRE

## Selecting a Flying Site

Selecting a flying site is critical to a successful flight. Airplanes require a lot more room than other R/C products, therefore, a neighborhood or parking lot is less than ideal. A large open field with short grass and generous overfly area are the best candidates if no AMA field is available in your area. Know your overfly area - ensure that there are no houses, playgrounds, or other buildings that may be damaged if the airplane were to crash.



## Takeoff

Taxi or place the aircraft on the runway centerline, with the nose into the wind. Select Flight Mode 2, then set throttle trim such that the motor spins over smoothly at its lowest RPM without stopping. Smoothly advance to full throttle while maintaining directional control with the rudder and slight back pressure on the elevator. The airplane should gently lift off.

Altitude is your friend on the first flight. Briskly climb to a safe altitude and trim the airplane out. Remain in mode 2 until the aircraft is fully trimmed and you are comfortable with its handling.

## Flying

The F-100D Super Sabre should fly straight and level at 3/4-full power with no input from the sticks. Try some basic maneuvers, and slowly progress into the F-100's flight envelope as you become more comfortable with the airplane's flight qualities and perfect your setup. **Note: If at any time, such as after gain adjustments, you experience unexpected control system inputs or oscillations, switch to Mode 1, land, and troubleshoot the issue. (Mode 1 turns the sensor inputs off with default programming)**

## Landing

Be mindful of your flight time and allow adequate battery reserve for a couple of landing attempts, if necessary, on the first few flights. Select Flight Mode 3 and using 0-1/4 throttle slow the F-100 to begin landing approach. On the upwind leg, select full flaps down then toggle CH5/Gear switch to deploy the gear. Visually verify the gear is fully deployed. Once on final approach, smoothly apply the elevator as required to maintain 0-4 degrees of nose high angle of attack. Use throttle to control the rate of descent. Once you are close to the ground, gradually reduce the throttle to idle and begin to smoothly apply up elevator as required to maintain 5-8 degrees of nose high angle of attack. The F-100 should gently touch down and roll out. **Remember, you can always smoothly advance the throttle to full, and make a go-around and set up for another landing.** You don't have to land on the first attempt.

## Trimming

The first several flights on your F-100D Super Sabre should be dedicated to trimming and setup. Fly the airplane at 2/3 to 3/4 power in Flight Mode 2 and trim for level flight. Land, adjust linkages and return the trim to zero and fly again. Repeat process until the airplane flies hands off, straight and level. Trim and/or sub-trim added via the transmitter will cause trim shifts when different flight modes are selected. To eliminate this trim shift, you have three options: (1) mechanically trim the model by turning the linkage clevises; (2) electronically trim the model via Aura Subtrim Feature in the Servo Ports tab of the Aura Config Tool; (3) Utilize the "Quick Trim" procedure below.

## Aura Quick Trim

The Aura 8 features a Quick Trim Mode that eliminates the need for mechanical linkage adjustments during test flights. Aura will learn the trim values from your transmitter, and apply them to the control surfaces after power up when enabling quick trim mode.

NOTE: Quick Trim can also be used BEFORE flying to make small changes to center the control surfaces before flight.

1. Fly the airplane in Flight Mode 2. Trim the aircraft with the transmitter and land. **DO NOT CHANGE FLIGHT MODES.**
2. Power off the Aura. Remove the servo lead plugged into Aura Port S3 and insert bind plug. Confirm that the transmitter is powered on and repower the Aura
3. Wait 5 seconds for the Aura to completely initialize. Confirm Quick Trim mode is active by checking the Blue LED is slowly flashing.
4. Remove the bind plug from **Aura Port S3**, and re-install the servo that was previously removed into S3. Removing the bind plug stores the current trims in the Aura. The Blue LED will flash quickly after control surface trim values are stored. While the trim values are stored in Aura, they are not applied to the control surfaces until the aircraft is repowered.
5. Remove power from the F-100D and center all control surface trims on the transmitter.
6. Repower the F-100. The control surfaces should be unchanged even though the trim has been centered on the transmitter.

NOTE: QUICK TRIM MAY BE REPEATED AS NEEDED FOR FINE TUNING, OR IF CHANGES TO THE AIRCRAFT ARE MADE.

NOTE: ENSURE AILERON/ELEVATOR/RUDDER TRANSMITTER SUB-TRIMS ARE ZERO BEFORE FLYING FOR QUICK TRIM PROCESS

## OPTIONAL EXPERT F-100D AURA CONFIGURATION

---

The “Expert” Aura Configuration offers three flight modes that are activated with your Flaps (CH6): General Flight, Takeoff, and Landing.

### Flight Mode 1 - General Flight

For all general flight tasks with the landing gear retracted. Flaps are up and the rates are set to low. “Tailerons” are active at their lowest rate. Gains are set to low and nose gear rate is set to high.

### Flight Mode 2 - Takeoff

For takeoffs with flaps set to half position. Gains are set to medium, rates are set to medium, and expo is tuned for comfortable flight. Nose gear rate is set to low. “Tailerons” are active at a medium rate.

### Flight Mode 3 - Landing

For landings with flaps set to full. Gains are highest, rates are highest and expo is tuned for comfortable flight. Nose gear rate is set to high. “Tailerons” are active at their highest rate.

## TURNING ON “EXPERT” MODE IN AURA

---

1. Make sure all power is removed from the F-100D.
2. Turn on your transmitter. Ensure you are in the correct model memory.
3. Remove the servo lead that is in Aura Port S2.
4. Insert a bind plug into Aura Port S2
5. Power the F-100D by plugging a battery into the ESC. The LEDs on the Aura will repeatedly double flash orange. This confirms you have entered the Quick Set Mode. The Green LED may be flashing, or solid. More information regarding the Green LED is below.
6. Use the Flap(CH6) switch (assigned earlier for Flaps) to select the Expert or Stock Aura Configurations.

If the Green LED on the Aura is **SOLID**, the Aura is set to use the **STOCK** configuration.

If the Green LED on the Aura is **FLASHING**, the Aura is set to use the **EXPERT** configuration.

7. Once you have selected your configuration, simply remove the bind plug from S2. All LEDs on Aura will be on while Aura is saving the settings. Once saved, the Aura will go back to it’s previous LED configuration from step 6. Power off the airplane and Aura, and replace the servo lead back into Aura Port S2.
8. Verify that all controls function, and that both transmitter direction test and Aura sensor test pass. Familiarize yourself with the new flight modes and their relative switch positions, and enjoy flying with your new flight modes!

The Expert program is gyro-enabled in all flight modes. If you wish to use a secondary switch to be able to turn Aura off, we recommend using the New Aura Config File Wizard, and setting up a Gyro Kill switch

For more information on how to access the Expert program via the Aura Config Tool, please visit:

[wiki.flexinnovations.com/wiki/F-100D](http://wiki.flexinnovations.com/wiki/F-100D)



# AIRCRAFT TROUBLESHOOTING GUIDE

Should you encounter any abnormal situations with your F-100D, refer to the matrix below to determine the probable cause and a recommended solution for the action.

If the required solution does not rectify the problem, please contact product support for further assistance.

DISCREPANCY	PROBABLE CAUSE	RECOMMENDED SOLUTION
Motor nonresponsive (ESC initialization tones audible)	Throttle not at idle and/or throttle trim too high	Lower throttle stick and trim completely. If problem persists, ensure that the sub-trim and travel adjust are properly set in the radio's programming.
	Throttle channel is reversed	Reverse throttle channel in radio programming
Motor nonresponsive (no ESC initialization tones audible)	Motor disconnected from ESC	Ensure plugs are fully seated. Check battery and/or plugs for damage and replace any damaged components found - DO NOT ATTEMPT REPAIR
Motor turns in the wrong direction	The three motor wires are connected incorrectly to the ESC	Swap any TWO motor wires.
Reduced flight time or aircraft underpowered	Flight battery not fully charged	Ensure battery is fully charged prior to installing in aircraft
	Fan installed backwards	Install fan so that the convex side faces forward
	Flight battery damaged	Remove battery from service completely and replace with a different battery
	Ambient temperature is too cold	Ensure battery packs are adequately warm (70°F/21°C) before flight
	Battery capacity too small for intended use	Replace battery with one of proper capacity and discharge capacity (C rating)
	ESC reaching preset LVC (low-voltage cutoff)	Recharge flight battery or reduce flight time
	Battery is too weak or damaged	Check battery's physical condition, check battery voltages after charge
Excessive fan noise and/or vibration	Battery's discharge rating may be too small	Replace battery with one with higher 'C' rating
	Damaged fan, collet, or motor	Replace damaged components - DO NOT ATTEMPT REPAIR
	Fan is not balanced	Balance or replace the fan
	Fan nut is loose	Tighten fan with appropriate-sized wrench
Control surfaces nonresponsive	Airframe or control linkage system damage	Examine airframe for damage, repair as required; inspect control linkage system (servo, pushrod, control horn) for damaged components and replace as required
	Wire damaged or connector loose	Examine wires and connections, replace as necessary
	Transmitter bound incorrectly, incorrect active model memory, incorrect Aura data input configuration, incorrect Aura transmitter settings	Consult radio manual for proper binding and model selection instructions
	Battery voltage too low	Use volt meter to check battery; recharge or replace as necessary
	Battery disconnected from ESC	Check that the EC5 plugs are fully seated
	BEC (battery elimination circuit) damaged	Replace ESC - DO NOT ATTEMPT REPAIR
Failed control direction test	Damaged Servo	Replace Servo - DO NOT ATTEMPT REPAIR
	Incorrect Aura 8 or Transmitter Setting - DO NOT FLY!	Reference transmitter and receiver sections of this manual. If no solution found, contact customer support at <a href="mailto:support@flexinnovations.com">support@flexinnovations.com</a>
Controls reversed	Aura 8 or transmitter settings incorrect	Refer to control surface direction chart and transmitter setup; adjust appropriate settings as required. Check F-100D and Aura wiki web pages for additional information. Contact customer support at <a href="mailto:support@flexinnovations.com">support@flexinnovations.com</a>
Control surface oscillation	Exceeding maximum airspeed for configuration	Reduce airspeed
	Gains too high for aircraft/flight configuration	Refer to Aura 8 manual to decrease desired control surface gain
	Fan/spinner not balanced	Balance or replace fan
	Motor vibration	Inspect motor mounting bolts and re-tighten as necessary
	Loose Aura 8 mounting	Re-align and secure the Aura 8 to the aircraft
	Control linkage slop	Examine control system and repair or replace work components
	Improper transmitter setup	Refer to Aura 8 manual to correctly configure transmitter
	Damaged fan	Replace damaged component- DO NOT ATTEMPT REPAIR
Trim changes between flight modes	Improperly set master gain	Ensure master gain is set for proper gain value
	Trims are not properly zeroed	Readjust control linkage and re-center trims in radio
	Transmitter sub-trim is not properly zeroed	Remove sub-trim; adjust the servo arm or clevis to achieve proper geometry
Retracts not deploying	Transmitter is not properly calibrated (aileron/elevator/rudder are not neutral with sticks centered; reference transmitter monitor)	Calibrate transmitter (reference manufacturer's instructions, or return to manufacturer for calibration)
		Set endpoints to -125% / +125%

## AIRFRAME REPAIRS

---

The F-100D Super Sabre is molded from durable EPO foam and is repairable with most adhesives. Similar to building and repairing wood or composite airplanes, the correct glue for a given application is critical to the repair holding and not breaking again. For major repairs, such as a broken fuselage, epoxy is preferred because it allows time to correct any misalignment. For smaller repairs, such as a cracked control surface or small chunk of material missing from the airframe, regular CA is very effective. The use of odorless (foam safe) CA is not recommended on EPO foam aircraft because it is weaker than regular CA and takes a longer period of time to cure and the bond tends to be weaker.

**NOTE:** Avoid the use of CA accelerant in repairs. It can damage paint and will weaken the bond of the glue. If CA accelerant is used, be mindful of the locations of CA to prevent premature bonding of parts, or bonding a hand or clamp to the airframe.

If a part is damaged too badly to be repaired, please refer to the front of the manual for a complete listing of spare airframe parts.

**NOTICE:** If a crash is imminent, fully reduce the throttle to prevent further damage to the power system and reduce energy to lessen impact damage.

***BE ADVISED THAT CRASH DAMAGE IS NOT COVERED UNDER ANY PRODUCT WARRANTY.***

Avoid keeping the airplane in direct sunlight when not flying. Excessive heat can damage the airplane's structure and UV damage can permanently discolor decals.

## REPLACING SERVOS

---

### Required Tools

#1 Phillips Screwdriver

1. Unplug the servo from the receiver.
2. Unscrew the servo arm from the servo and remove the servo arm.
3. Unscrew the mounting screw located at each end of the servo and remove.

## SERVICING THE POWER SYSTEM

---

### Required Tools and Fasteners:

#1 Phillips Screwdriver  
#2 Phillips Screwdriver  
M3 Hex Driver  
Adjustable Wrench

1. Remove the access hatch using a #2 Phillips screwdriver.
2. Unplug the 3-motor wires from the ESC.
3. Using #1 Phillips screwdriver, remove the M3x6 Phillips washer head sheet metal screws that secure the EDF fan unit to the EDF mounting rails.
4. Using #1 Phillips screwdriver, remove the M3x6 Phillips machine screw that secures the rotor cone to the rotor.
5. Using an adjustable wrench, remove the M8 nut from the motor adapter. Slide the motor adapter off of the motor shaft.
6. Using a M3 hex driver, remove the (4) M3x6 screws that secure the motor to the EDF housing.
7. To remove the ESC, disconnect the ESC from the receiver or the Aura, and remove any cable ties holding the ESC to the fuselage.

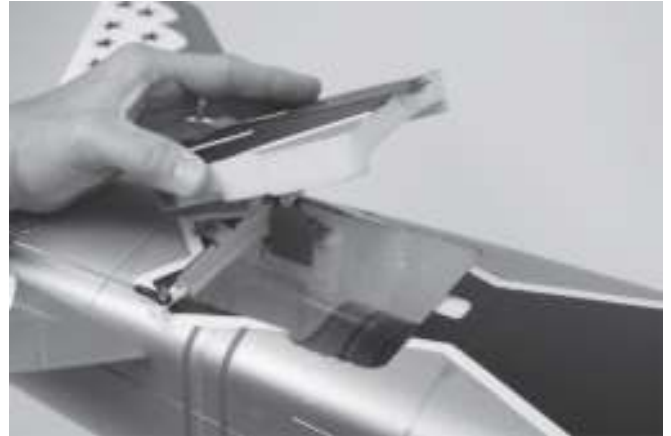

# LIMITED WARRANTY

## Warranty Coverage

Flex Innovations, LLC. and its authorized resellers ("Flex") warrant to the original purchaser that the product purchased (the "Product") it will be free from defects in materials and workmanship at the date of purchase.

## Outside of Coverage

This warranty is not transferable and does not cover:

- (a) Products with more than 45 days after purchased date.
- (b) Damage due to acts of God, accident, misuse, abuse, negligence, commercial use, or due to improper use, installation, operation or maintenance
- (c) Modification of or to any part of the Product.
- (d) Product not compliant with applicable technical regulations.
- (e) Shipping damage.
- (f) Cosmetic damage

**OTHER THAN THE EXPRESS WARRANTY ABOVE, FLEX MAKES NO OTHER WARRANTY OR REPRESENTATION, AND HEREBY DISCLAIMS ANY AND ALL IMPLIED WARRANTIES, INCLUDING, WITHOUT LIMITATION, THE IMPLIED WARRANTIES OF NONINFRINGEMENT, MERCHANTABILITY AND FITNESS FOR A PARTICULAR PURPOSE. THE PURCHASER ACKNOWLEDGES THAT THEY ALONE HAVE DETERMINED THAT THE PRODUCT WILL SUITABLY MEET THE REQUIREMENTS OF THE PURCHASER'S INTENDED USE.**

## Purchaser's Solution

Flex's sole obligation and purchaser's sole and exclusive remedy shall be that Flex will, at its option, either (i) service, or (ii) replace, any Product determined by Flex to be defective. Flex reserves the right to inspect any and all Product(s) involved in a warranty claim. Service or replacement decisions are at the sole discretion of Flex. Proof of purchase is required for all warranty claims. **SERVICE OR REPLACEMENT AS PROVIDED UNDER THIS WARRANTY IS THE PURCHASER'S SOLE AND EXCLUSIVE REMEDY.**

## Limitation of Liability

**FLEX SHALL NOT BE LIABLE FOR SPECIAL, INDIRECT, INCIDENTAL OR CONSEQUENTIAL DAMAGES, LOSS OF PROFITS OR PRODUCTION OR COMMERCIAL LOSS IN ANY WAY, REGARDLESS OF WHETHER SUCH CLAIM IS BASED IN CONTRACT, WARRANTY, TORT, NEGLIGENCE, STRICT LIABILITY OR ANY OTHER THEORY OF LIABILITY, EVEN IF FLEX HAS BEEN ADVISED OF THE POSSIBILITY OF SUCH DAMAGES.**

Further, in no event shall the liability of Flex exceed the individual price of the Product on which liability is asserted. As Flex has no control over use, setup, assembly, modification or misuse, no liability shall be assumed nor accepted for any resulting damage or injury. By the act of use, setup or assembly, the user accepts all resulting liability. If you as the purchaser or user are not prepared to accept the liability associated with the use of the Product, purchaser is advised to return the Product immediately in new and unused condition to the place of purchase.

## Law

These terms are governed by Florida law (without regard to conflict of law principals). This warranty gives you specific legal rights, and you may also have other rights which vary from state to state. **FLEX RESERVES THE RIGHT TO MODIFY THIS WARRANTY AT ANY TIME WITHOUT PRIOR NOTICE.**

## Questions & Assistance

Visit <https://www.flexinnovations.com/flex-dealers/> for customer support in your region.

## Inspection or Services

If this Product needs to be inspected or serviced and is compliant in the region you live and use the Product in, please contact your regional Flex authorized reseller. Pack the Product securely using a shipping carton. Please note that original boxes needs to be included, but are not designed to withstand the rigors of shipping without additional protection. Ship via a carrier that provides tracking and insurance for lost or damaged parcels, as Flex is not responsible for merchandise until it arrives and is accepted at our facility.

## Warranty Requirements

For Warranty consideration, you must include your original sales receipt verifying the proof of purchase date. Provided warranty conditions have been met, your Product will be replaced free of charge. Shipping charges are as follow: to Flex by customer, Flex out it is by Flex. Service or replacement decisions are at the sole discretion of Flex.

## COMPLIANCE INFORMATION FOR THE EUROPEAN UNION

 **Declaration of Conformity** (In accordance with ISO/IEC 17050-1)

Product(s): F-100D Super Sabre PNP  
Item Number(s): FPM4070A, FPM4070B

F-100D Super Sabre PNP Silver  
F-100D Super Sabre PNP Green

The object of declaration described above is in conformity with the requirements of the specifications listed below, following the provisions of the EMC Directive 2004/108/EC.

**EN 55022: 2010+AC: 2011**  
**EN 55024: 2010**  
**EN 61000-3-2: 2006+A2:2009**  
**EN 61000-3-3: 2013**

**EN 61000-6-3: 2007/A1:2011**  
**EN 61000-6-1: 2007**



Instructions for disposal of WEEE by users in the European Union

This product must not be disposed of with other waste. Instead, it is the user's responsibility to dispose of their waste equipment by handing it over to a designated collections point for the recycling of waste and electronic equipment. The separate collection and recycling of your waste equipment at the time of disposal will help to conserve natural resources and ensure that it is recycled in a manner that protects human health and the environment. For more information about where to drop off your waste equipment for recycling, please contact your local city office, your household waste disposal service or where you purchased the product.

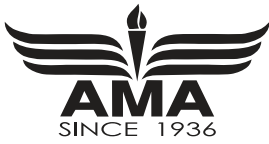

# Academy of Model Aeronautics National Model Aircraft Safety Code Effective January 1, 2014

A. GENERAL: A model aircraft is a non-human-carrying aircraft capable of sustained flight in the atmosphere. It may not exceed limitations of this code and is intended exclusively for sport, recreation, education and/or competition. All model flights must be conducted in accordance with this safety code and any additional rules specific to the flying site.

1. Model aircraft will not be flown:
  - (a) In a careless or reckless manner.
  - (b) At a location where model aircraft activities are prohibited.
2. Model aircraft pilots will:
  - (a) Yield the right of way to all human-carrying aircraft.
  - (b) See and avoid all aircraft and a spotter must be used when appropriate. (AMA Document #540-D.)
  - (c) Not fly higher than approximately 400 feet above ground level within three (3) miles of an airport without notifying the airport operator.
  - (d) Not interfere with operations and traffic patterns at any airport, heliport or seaplane base except where there is a mixed use agreement.
  - (e) Not exceed a takeoff weight, including fuel, of 55 pounds unless in compliance with the AMA Large Model Airplane program. (AMA Document 520-A.)
  - (f) Ensure the aircraft is identified with the name and address or AMA number of the owner on the inside or affixed to the outside of the model aircraft. (This does not apply to model aircraft flown indoors.)
  - (g) Not operate aircraft with metal-blade propellers or with gaseous boosts except for helicopters operated under the provisions of AMA Document #555.
  - (h) Not operate model aircraft while under the influence of alcohol or while using any drug that could adversely affect the pilot's ability to safely control the model.
  - (i) Not operate model aircraft carrying pyrotechnic devices that explode or burn, or any device which propels a projectile or drops any object that creates hazard to persons or property.

#### Exceptions:

- Free Flight fuses or devices that burn producing smoke and are securely attached to the model aircraft during flight.
  - Rocket motors (using solid propellant) up to a G-series size may be used provided they remain attached to the model during flight. Model rockets may be flown in accordance with the National Model Rocketry Safety Code but may not be launched from model aircraft.
  - Officially designated AMA Air Show Teams (AST) are authorized to use devices and practices as defined within the Team AMA Program Document. (AMA Document #718.)
  - (j) Not operate a turbine-powered aircraft, unless in compliance with the AMA turbine regulations. (AMA Document #510-A.)
3. Model aircraft will not be flown in AMA sanctioned events, air shows or model demonstrations unless:
    - (a) The aircraft, control system and pilot skills have successfully demonstrated all maneuvers intended or anticipated prior to the specific event.
    - (b) An inexperienced pilot is assisted by an experienced pilot.
  4. When and where required by rule, helmets must be properly worn and fastened. They must be OSHA, DOT, ANSI, SNELL or NOCSAE approved or comply with comparable standards.

#### B. RADIO CONTROL (RC)

1. All pilots shall avoid flying directly over unprotected people, vessels, vehicles or structures and shall avoid endangerment of life and property of others.
2. A successful radio equipment ground-range check in accordance with manufacturer's recommendations will be completed before the first flight of a new or repaired model aircraft.
3. At all flying sites a safety line(s) must be established in front of which all flying takes place. (AMA Document #706.)
  - (a) Only personnel associated with flying the model aircraft are allowed at or in front of the safety line.
  - (b) At air shows or demonstrations, a straight safety line must be established.
  - (c) An area away from the safety line must be maintained for spectators.

4. RC model aircraft must use the radio-control frequencies currently allowed by the Federal Communications Commission (FCC). Only individuals properly licensed by the FCC are authorized to operate equipment on Amateur Band frequencies.
5. RC model aircraft will not knowingly operate within three (3) miles of any pre-existing flying site without a frequency-management agreement. (AMA Documents #922 and #923.)
6. With the exception of events flown under official AMA Competition Regulations, excluding takeoff and landing, no powered model may be flown outdoors closer than 25 feet to any individual, except for the pilot and the pilot's helper(s) located at the flightline.
7. Under no circumstances may a pilot or other person touch an outdoor model aircraft in flight while it is still under power, except to divert it from striking an individual.
8. RC night flying requires a lighting system providing the pilot with a clear view of the model's attitude and orientation at all times. Hand-held illumination systems are inadequate for night flying operations.
9. The pilot of an RC model aircraft shall:
  - (a) Maintain control during the entire flight, maintaining visual contact without enhancement other than by corrective lenses prescribed for the pilot.
  - (b) Fly using the assistance of a camera or First-Person View (FPV) only in accordance with the procedures outlined in AMA Document #550.
  - (c) Fly using the assistance of autopilot or stabilization system only in accordance with the procedures outlined in AMA Document #560.

#### C. FREE FLIGHT

1. Must be at least 100 feet downwind of spectators and automobile parking when the model aircraft is launched.
2. Launch area must be clear of all individuals except mechanics, officials, and other fliers.
3. An effective device will be used to extinguish any fuse on the model aircraft after the fuse has completed its function.

#### D. CONTROL LINE

1. The complete control system (including the safety thong where applicable) must have an inspection and pull test prior to flying.
2. The pull test will be in accordance with the current Competition Regulations for the applicable model aircraft category.
3. Model aircraft not fitting a specific category shall use those pull-test requirements as indicated for Control Line Precision Aerobatics.
4. The flying area must be clear of all utility wires or poles and a model aircraft will not be flown closer than 50 feet to any above-ground electric utility lines.
5. The flying area must be clear of all nonessential participants and spectators before the engine is started.

If you are not an AMA member, please consider joining. Founded in 1936 and open to anyone interested in model aviation, the AMA is the governing body for model aviation in the United States and sanctions over 2,000 competitions annually. Membership in the AMA provides liability insurance coverage, protects modelers' rights and interests, and is required to fly at most of the 2,700+ R/C sites nationwide.

Academy of Model Aeronautics  
5161 East Memorial Drive  
Muncie, IN 47302-9252  
Toll Free (800) 435-9262  
Fax (765) 741-0057

[www.modelaircraft.org](http://www.modelaircraft.org)



© 2020 Flex Innovations, LLC  
Potenza™ is a trademark or registered trademark of Flex Innovations, LLC  
DSM®, DSM2™, and DSMX™ are trademarks of Horizon Hobby, Inc.  
Futaba is a registered trademark of Futaba Denshi Kogyo Kabushiki Kaisha Corporation of Japan.  
Jeti, UDI, and Jeti Model are trademarks or registered trademarks of Jelen, Ing. Stanislav of Czech Republic  
HoTT is a registered trademark of SJ, Inc.