

MODEL 89086-4

MAVOK®

TRAXXAS®

OWNER'S MANUAL

INTRODUCTION

- 3 BEFORE YOU PROCEED
- 4 SAFETY PRECAUTIONS
- 6 TOOLS, SUPPLIES AND REQUIRED EQUIPMENT
- 7 ANATOMY OF THE TRAXXAS MAXX
- 8 QUICK START: GETTING UP TO SPEED
- 9 TRAXXAS TQi RADIO SYSTEM
- 17 ADJUSTING THE ELECTRONIC SPEED CONTROL
- 20 DRIVING YOUR MODEL
- 23 BASIC TUNING ADJUSTMENTS
- 26 MAINTAINING YOUR MODEL
- 28 TQi ADVANCED TUNING GUIDE

Thank you for purchasing the Traxxas Maxx® electric monster truck equipped with the Velineon® VXL-4s Brushless Power System. With a tire-scorching 55+ mph top speed out of the box, the Maxx's VXL-4s power system punches far above its weight class. The Velineon 540XL 2400Kv brushless motor pulls effortless wheelies at nearly any speed and rips massive roosts with a touch of the trigger. Ferocious speed. Radical design. Brute strength. The Traxxas Maxx is the new face of Traxxas Tough.

This manual contains the instructions you will need to operate and maintain your model so that you can enjoy it for years to come. We want you to feel confident that you own one of the best-performing models in the market and that it is backed by a team of professionals who aim to provide the highest level of factory support possible. Traxxas models are about experiencing total performance and satisfaction, not just with your model, but also with the company that stands behind it.

We know you're excited about getting your new model on the road, but it's very important that you take time to read through the Owners Manual. This manual contains all the necessary set-up and operating procedures that allow you to unlock the performance and potential that Traxxas engineers designed into your model. **Even if you are an experienced RC enthusiast, it's important to read and follow the procedures in this manual.**

Thank you again for going with Traxxas. We work hard every day to assure you the highest level of customer satisfaction possible. We truly want you to enjoy your new model!

FCC Compliance

This device contains a module that complies with the limits for a Class B digital device as described in part 15 of the FCC rules. Operation is subject to the following two conditions: (1) This device may not cause harmful interference, and (2) this device must accept any interference received, including interference that may cause undesired operation.

The limits for a Class B digital device are designed to provide reasonable protection against harmful interference in residential settings. This product generates, uses, and can radiate radio frequency energy, and, if not operated in accordance with the instructions, may cause harmful interference to radio communications. The user is cautioned that changes or modifications not expressly approved by the party responsible for compliance could void the user's authority to operate the equipment.

Canada, Industry Canada (IC)

This Class B digital apparatus complies with Canadian ICES-003 and RSS-210. This device complies with Industry Canada license exempt RSS standard(s). Operation is subject to the following two conditions: This device may not cause interference, and this device must accept any interference, including interference that may cause undesired operation of the device.

Radio Frequency (RF) Exposure Statement

This equipment complies with radio frequency exposure limits set forth by FCC and Industry Canada for an uncontrolled environment. This equipment should be installed and operated with a minimum distance of 20 centimeters between the radiator and your body or bystanders and must not be co-located or operating in conjunction with any other antenna or transmitter.

Operation Frequency: 2414~2453 MHz

Maximum Radio Frequency Power: Maximum Peak Power 9.7 dBm

Traxxas Support

Traxxas support is with you every step of the way. Refer to the next page to find out how to contact us and what your support options are.



Quick Start

This manual is designed with a Quick Start path that outlines the necessary procedures to get your model up and running in the shortest time possible. If you are an experienced RC enthusiast you will find it helpful and fast. Be sure and read through the rest of the manual to learn about important safety, maintenance, and adjustment procedures. Turn to page 8 to begin.



REGISTERING YOUR MODEL

In order to serve you better as our customer, please register your product within 10 days of your purchase online at [Traxxas.com/register](https://www.traxxas.com/register).

[Traxxas.com/register](https://www.traxxas.com/register)

BEFORE YOU PROCEED

Carefully read and follow all instructions in this and any accompanying materials to prevent serious damage to your model. Failure to follow these instructions will be considered abuse and/or neglect.

Before running your model, look over this entire manual and examine the model carefully. If for some reason you decide it is not what you wanted, then do not continue any further. **Your hobby dealer absolutely cannot accept a model for return or exchange after it has been run.**

Warnings, Helpful Hints, & Cross-References

Throughout this manual, you'll notice warnings and helpful hints identified by the icons below. Be sure to read them!



An important warning about personal safety or avoiding damage to your model and related components.



Special advice from Traxxas to make things easier and more fun.



Refers you to a page with a related topic.

SUPPORT

If you have any questions about your model or its operation, call the Traxxas Technical Support line toll-free at: **1-888-TRAXXAS (1-888-872-9927)***

Technical support is available Monday through Friday from 8:30am to 9:00pm central time. Technical assistance is also available at Traxxas.com. You may also e-mail customer support with your question at support@Traxxas.com. Join thousands of registered members in our online community at Traxxas.com.

Traxxas offers a full-service, on-site repair facility to handle any of your Traxxas service needs. Maintenance and replacement parts may be purchased directly from Traxxas by phone or online at Traxxas.com. You can save time, along with shipping and handling costs, by purchasing replacement parts from your local dealer.

Do not hesitate to contact us with any of your product support needs. We want you to be thoroughly satisfied with your new model!

Traxxas
6250 Traxxas Way
McKinney, Texas 75070
Phone: 972-549-3000
Toll-free 1-888-TRAXXAS

Internet
Traxxas.com
E-mail: support@Traxxas.com

Entire contents ©2022 Traxxas. Traxxas, Ready-To-Race, Ready-To-Win, Maxx, Velineon, and ProGraphix are trademarks or registered trademarks of Traxxas. Other brand names and marks are the property of their respective holders and are used only for purposes of identification. No part of this manual may be reproduced or distributed in print or electronic media without the express written permission of Traxxas. Specifications are subject to change without notice.

*Toll-free support is available to U.S. residents only.

SAFETY PRECAUTIONS



All instructions and precautions outlined in this manual should be strictly followed to ensure safe operation of your model.



This model is not intended for use by children under 14 years of age without the supervision of a responsible and knowledgeable adult.



Previous experience with radio controlled models is mandatory. Models require detailed setup and/or maintenance procedures with required support equipment. These models are capable of high speeds, requiring experienced driving control.

All of us at Traxxas want you to safely enjoy your new model. Operate your model sensibly and with care, and it will be exciting, safe, and fun for you and those around you. Failure to operate your model in a safe and responsible manner may result in property damage and serious injury. The precautions outlined in this manual should be strictly followed to help ensure safe operation. You alone must see that the instructions are followed and the precautions are adhered to.

Important Points to Remember

- Your model is not intended for use on public roads or congested areas where its operation can conflict with or disrupt pedestrian or vehicular traffic.
- Never, under any circumstances, operate the model in crowds of people. Your model could cause injury if allowed to collide with anyone.
- Because your model is controlled by radio, it is subject to radio interference from many sources that are beyond your control. Since radio interference can cause momentary losses of radio control, always allow a safety margin in all directions around the model in order to prevent collisions.
- The motor, battery, and speed control can become hot during use. Be careful to avoid getting burned.
- Don't operate your model at night, or anytime your line of sight to the model may be obstructed or impaired in any way.
- **Most importantly, use good common sense at all times.**

Speed Control

Your model's electronic speed control (ESC) is an extremely powerful electronic device capable of delivering high current. Please closely follow these precautions to prevent damage to the speed control or other components.

- **Disconnect the Battery:** Always disconnect the battery from the speed control when not in use.
- **Insulate the Wires:** Always insulate exposed wiring with heat shrink tubing to prevent short circuits.
- **Transmitter on First:** Switch on your transmitter first before switching on the speed control to prevent runaways and erratic performance.
- **Don't Get Burned:** The ESC and motor can become extremely hot during use, so be careful not to touch them until they cool. Supply adequate airflow for cooling.
- **Use the Factory-Installed Connectors:** Do not change the battery and motor connectors. Improper wiring can cause fire or damage to the ESC. Please note that modified speed controls can be subject to a rewiring fee when returned for service.
- **No Reverse Voltage:** The ESC is not protected against reverse polarity voltage.
- **No Schottky Diodes:** External Schottky diodes are not compatible with reversing speed controls. Using a Schottky diode with your Traxxas speed control will damage the ESC and void the 30-day warranty.
- **Always** adhere to the minimum and maximum limitations of the speed control as stated in the specifications table in the Owner's Manual. If your ESC operates on two batteries, do not mix battery types and capacities. Use the same voltage and capacity for both batteries. Using mismatched battery packs could damage the batteries and electronic speed control.



WARNING! CAUTION! DANGER!



FIRE HAZARD! This vehicle requires LiPo batteries. Charging and discharging batteries has the potential for fire, explosion, serious injury, and property damage if not performed per the instructions. In addition, Lithium Polymer (LiPo) batteries pose a SEVERE risk of fire if not properly handled per the instructions and require special care and handling procedures for long life and safe operation. LiPo batteries are intended only for advanced users that are educated on the risks associated with LiPo battery use. Traxxas does not recommend that anyone under the age of 14 use or handle LiPo battery packs without the supervision of a knowledgeable and responsible adult. Dispose of used batteries according to the instructions.

- Your model requires the use of LiPo batteries. LiPo batteries have a minimum safe discharge voltage threshold that should not be exceeded. The electronic speed control is equipped with built-in Low-Voltage Detection that alerts the driver when LiPo batteries have reached their minimum voltage (discharge) threshold. It is the driver's responsibility to stop immediately to prevent the battery pack from being discharged below its safe minimum threshold.
- Low-Voltage Detection is just one part of a comprehensive plan for safe LiPo battery use. It is critical to follow all instructions for safe and proper charging, use, and storage of LiPo batteries. Make sure you understand how to use your LiPo batteries. If you have questions about LiPo battery usage, please consult with your local hobby dealer or contact the battery manufacturer. As a reminder, all batteries should be recycled at the end of their useful life.
- DO NOT use a charger designed for NiMH or NiCad batteries. The use of a NiMH or NiCad charger or charge mode will damage the batteries. Failure to use the correct charger may result in battery damage, fire, personal injury, and/or property damage.
- ALWAYS inspect your LiPo batteries carefully before charging. Do not use or charge battery packs that have been damaged in any way (bent, dented, swollen, torn covering, or otherwise damaged).
- BEFORE you charge, ALWAYS confirm that the charger settings exactly match the type (chemistry), specification, and configuration of the battery to be charged. DO NOT exceed the maximum manufacturer recommended charge rate. DO NOT attempt to charge non-rechargeable batteries (explosion hazard), batteries that have an internal charge circuit or a protection circuit, or batteries that have been altered from original manufacturer configuration.
- While charging or discharging, ALWAYS place the battery (all types of batteries) in a fire retardant/fire proof container and on a non-flammable surface such as concrete.
- ALWAYS charge batteries in a well-ventilated area.
- Charge the battery in a safe area away from flammable materials. Monitor the charging process and never leave batteries unattended while charging. Do not allow small children to charge or handle LiPo batteries.
- DO NOT disassemble, crush, short circuit, or expose the batteries to flame or other source of ignition.
- DO NOT let any exposed battery contacts or wires touch each other. This will cause the battery to short circuit and create the risk of fire.
- DO NOT leave the charger and battery unattended while charging, discharging, or anytime the charger is ON with a battery connected. If there are any signs of a malfunction, unplug the power source and/or stop the charging process immediately.
- ALWAYS unplug the charger from the wall outlet and disconnect the battery when not in use.
- Never charge LiPo battery packs in series or parallel. Charging packs in series or parallel may result in improper charger cell recognition and an improper charging rate that may lead to overcharging, cell imbalance, cell damage and fire.
- If a battery gets hot to the touch during the charging process (temperature greater than 110°F / 43°C), immediately disconnect the battery from the charger and discontinue charging.
- DO NOT store or charge LiPo batteries with or around other batteries or battery packs of any type, including other LiPos.
- Store and transport your LiPo batteries in a cool dry place. DO NOT store in direct sunlight. DO NOT allow the storage temperature to exceed 140°F or 60°C such as in the trunk of a car or the cells may be damaged and risk of fire created. ALWAYS store battery packs safely out of the reach of children and pets.
- Keep a Class D fire extinguisher nearby in case of fire.
- DO NOT disassemble LiPo batteries or cells. DO NOT disassemble the charger.
- DO NOT attempt to build your own LiPo battery pack from loose cells.
- REMOVE the battery from your model or device before charging.
- DO NOT expose the charger to water or moisture.

TOOLS, SUPPLIES AND REQUIRED EQUIPMENT



For more information on batteries, see *Use the Right Batteries* on page 12.



Recommended Equipment
These items are not required for the operation of your model, but are a good idea to include in any RC toolbox:

- Safety glasses
- Traxxas Ultra Premium Tire Glue, part #6468 (CA glue)
- Hobby knife
- Side cutters and/or needle nose pliers
- Soldering iron

Your model comes with a set of specialty metric tools. You'll need to purchase other items, available from your hobby dealer, to operate and maintain your model.

Supplied Tools and Equipment



2.5mm "L" wrench



2.0mm "L" wrench



Universal wrench

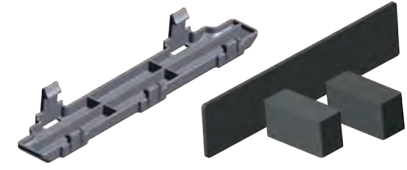

Battery pack spacers

Required Equipment (not included)



3s/4s LiPo battery pack with Traxxas High Current Connector



Battery charger



4 AA alkaline batteries

*Battery and charger style is subject to change and may vary from images.

REMOVING AND INSTALLING THE BODY

Your Maxx includes an innovative latching system for securing the body to the chassis. To remove the body for chassis access:

1. Turn the handle 90 degrees counterclockwise to unlock the body latch.
2. Open the latch to release the truck body from the rear shock tower.
3. Gently lift the rear of the body. Do not lift too far or the body will become difficult to remove.
4. Slide the body backward away from the front shock tower to release the front body tab. (Installation of the body is the reverse of removal.)
5. Practice this a few times until you become familiar with the latching mechanism. The more you do it, the faster you will be.



ANATOMY OF THE TRAXXAS MAXX

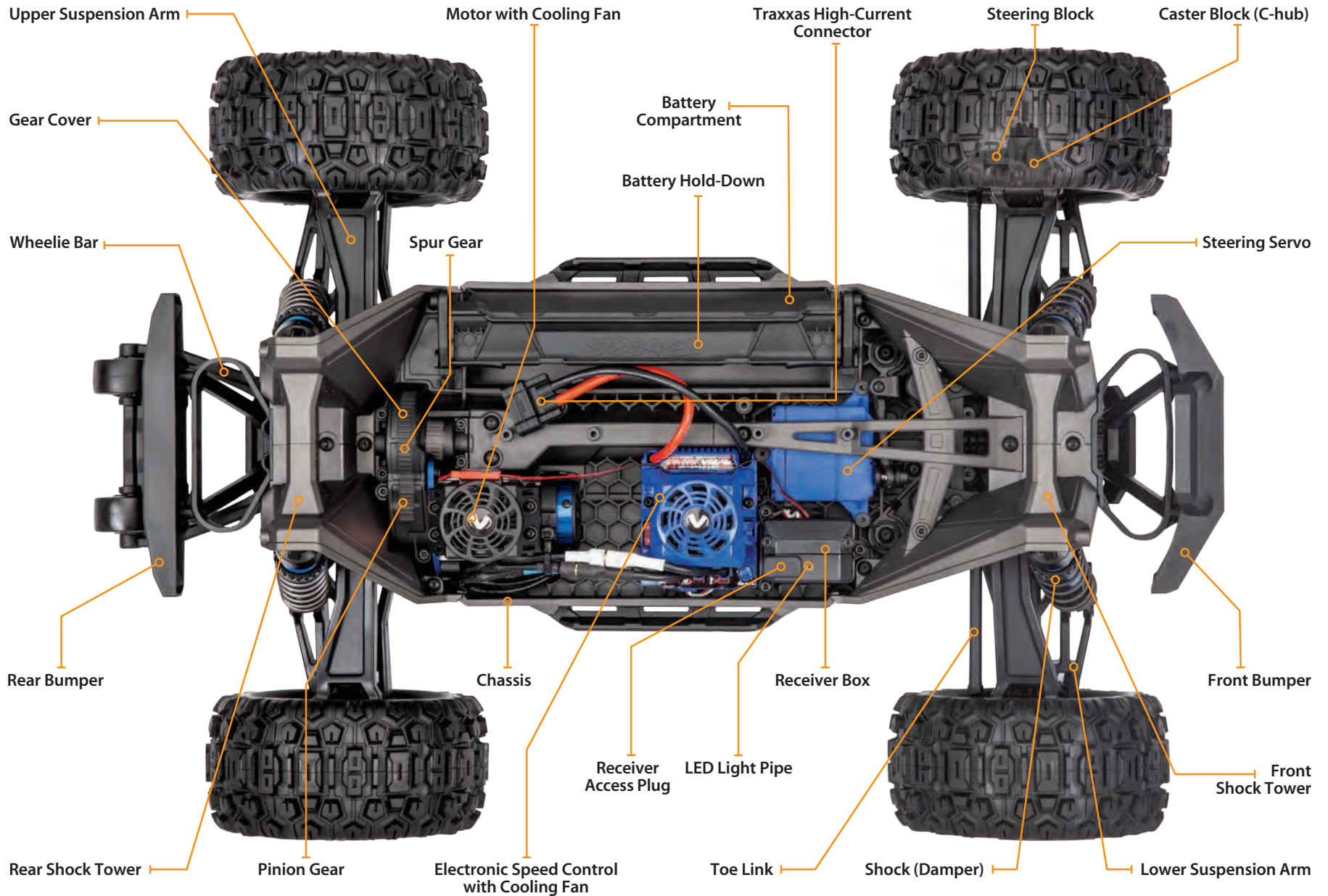

QUICK START: GETTING UP TO SPEED



The Quick Start Guide is not intended to replace the full operating instructions available in this manual. Please read this entire manual for complete instructions on the proper use and maintenance of your model.

The following guide is an overview of the procedures for getting your model running. Look for the Quick Start logo on the bottom corners of Quick Start pages.

1. Read the safety precautions on pages 4-5

For your own safety, understand where carelessness and misuse could lead to personal injury.

6. Check servo operation • See page 14

Make sure the steering servos are working correctly.

2. Charge the battery pack • See page 12

Your model requires a LiPo battery pack and a compatible battery charger (sold separately). Never use a NiMH or NiCad charger to charge LiPo battery packs.

7. Range test the radio system • See page 15

Follow this procedure to make sure your radio system works properly at a distance and that there is no interference from outside sources.

3. Install batteries in the transmitter • See page 12

The transmitter requires 4 AA alkaline batteries (sold separately).

8. Detail your model • See page 9

Apply other decals if desired.

4. Install battery packs in the model • See pages 13

Your model requires a fully charged battery pack (not included).

9. Drive your model • See page 20

Driving tips and adjustments for your model.

5. Turn on the radio system • See page 13

Make a habit of turning the transmitter on first, and off last.

10. Maintaining your model • See page 26

Follow these critical steps to maintain the performance of your model and keep it in excellent running condition.

Look for the Quick Start logo at the bottom of Quick Start pages.



INTRODUCTION

Your model includes the latest Traxxas TQi 2.4GHz transmitter with Traxxas Link™ Model Memory. The transmitter's easy-to-use design provides instant driving fun for new RC enthusiasts, and also offers a full compliment of pro-level tuning features for advanced users – or anyone interested in experimenting with the performance of their model. The steering and throttle channels feature adjustable Exponential, End Points, and Sub-Trims. Steering and braking Dual Rate are also available. Many of the next-level features are controlled by the Multi-Function knob, which can be programmed to control a variety of functions. The detailed instructions (page 28) and Menu Tree (page 31) included in this manual will help you understand and operate the advanced functions of the new TQi radio system. For additional information and how-to videos, visit Traxxas.com.

RADIO AND POWER SYSTEM TERMINOLOGY

Please take a moment to familiarize yourself with these radio and power system terms. They will be used throughout this manual. A detailed explanation of the advanced terminology and features of your new radio system begins on page 28.

2.4GHz Spread Spectrum – This model is equipped with the latest RC technology. Unlike AM and FM systems that require frequency crystals and are prone to frequency conflicts, the TQi system automatically selects and locks onto an open frequency, and offers superior resistance to interference and “glitching.”

BEC (Battery Eliminator Circuit) - The BEC can either be in the receiver or in the ESC. This circuit allows the receiver and servos to be powered by the main battery pack in an electric model. This eliminates the need to carry a separate pack of 4 AA batteries to power the radio equipment.

Brushless Motor - A D/C brushless motor replaces the brushed motor's traditional commutator and brush arrangement with intelligent electronics that energize the electromagnetic windings in sequence to provide rotation. Opposite of a brushed motor, the brushless motor has its windings (coils) on the perimeter of the motor can and the magnets are mounted to the spinning rotor shaft.

Cogging - Cogging is a condition sometimes associated with brushless motors. Typically it is a slight stutter noticed when accelerating from a stop. It happens for a very short period as the signals from the electronic speed control and the motor synch with each other.

Current - Current is a measure of power flow through the electronics, usually measured in amps. If you look at wire like a garden hose, current is a measure of how much water is flowing through the hose.

ESC (Electronic Speed Control) - An electronic speed control is the electronic motor control inside the model. Electronic speed controls use power more efficiently than mechanical speed controls so that the battery runs longer. An electronic speed control also has circuitry that prevents loss of steering and throttle control as the battery loses its charge.

Frequency band - The radio frequency used by the transmitter to send signals to your model. This model operates on the 2.4GHz direct-sequence spread spectrum.

kV Rating - Brushless motors are often rated by their kV number. The kV rating equals no-load motor rpm with 1 volt applied. The kV increases as the number of wire turns in the motor decreases. As the kV increases, the current draw through the electronics also increases.

LiPo - Abbreviation for Lithium Polymer. Rechargeable LiPo battery packs are known for their special chemistry that allows extremely high energy density and current handling in a compact size. These are high performance batteries that require special care and handling. For advanced users only.

mAh - Abbreviation for milliamp hour. A measure of the capacity of the battery pack. The higher the number, the longer the battery will last between recharges.

Neutral position - The standing position that the servos seek when the transmitter controls are at the neutral setting.



Applying the Decals

The main decals for your model have been applied at the factory. The decals are printed on self-adhesive clear mylar and are die-cut for easy removal. Use a hobby knife to lift the corner of a decal and lift it from the backing.

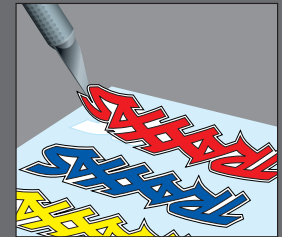

To apply the decals, place one end down, hold the other end up, and gradually smooth the decal down with your finger as you go. This will prevent air bubbles. Placing both ends of the decal down and then trying to smooth it out will result in air pockets. Look at the photos on the box for typical decal placement.

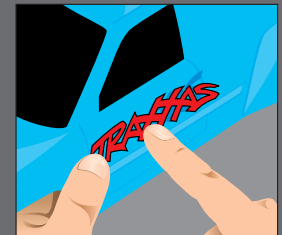



To prevent loss of radio range do not kink or cut the black wire, do not bend or cut the metal tip, and do not bend or cut the white wire at the end of the metal tip.

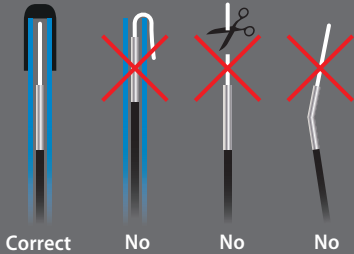

NiCad - Abbreviation for nickel-cadmium. The original rechargeable hobby pack, NiCad batteries have very high current handling, high capacity, and can last up to 1000 charging cycles. Good charging procedures are required to reduce the possibility of developing a “memory” effect and shortened run times.

NiMH - Abbreviation for nickel-metal hydride. Rechargeable NiMH batteries offer high current handling, and much greater resistance to the “memory” effect. NiMH batteries generally allow higher capacity than NiCad batteries. They can last up to 500 charge cycles. A peak charger designed for NiMH batteries is required for optimal performance.

Receiver - The radio unit inside your model that receives signals from the transmitter and relays them to the servos.

Resistance - In an electrical sense, resistance is a measure of how an object resists or obstructs the flow of current through it. When flow is constricted, energy is converted to heat and is lost. Traxxas power systems are optimized to reduce electrical resistance and the resulting power-robbing heat.

Rotor - The rotor is the main shaft of the brushless motor. In a brushless motor, the magnets are mounted to the rotor, and the electromagnetic windings are built into the motor housing.

Sensored - Sensored refers to a type of brushless motor that uses an internal sensor in the motor to communicate rotor position information back to the electronic speed control.

Sensorless - Sensorless refers to a brushless motor that uses advanced instructions from an electronic speed control to provide smooth operation. Additional motor sensors and wiring are not required.

Servo - Small motor unit in your model that operates the steering mechanism.

Solder Tabs - Accessible, external contacts on the motor that allows for easy wire replacement.

Transmitter - The hand-held radio unit that sends throttle and steering instructions to your model.

Trim - The fine-tuning adjustment of the neutral position of the servos, made by adjusting the throttle and steering trim knobs on the face of the transmitter. **Note:** The Multi-Function knob must be programmed to serve as a throttle trim adjustment.

Thermal Shutdown Protection - Temperature sensing electronics used in the electronic speed control detect overloading and overheating of the transistor circuitry. If excessive temperature is detected, the unit automatically shuts down to prevent damage to the electronics.

2-channel radio system - The TQi radio system, consisting of the receiver, the transmitter, and the servos. The system uses two channels: one to operate the throttle and one to operate the steering.

Voltage - Voltage is a measure of the electrical potential difference between two points, such as between the positive battery terminal and ground. Using the analogy of the garden hose, while current is the quantity of water flow in the hose, voltage corresponds to the pressure that is forcing the water through the hose.

IMPORTANT RADIO SYSTEM PRECAUTIONS

- Do not kink the receiver’s antenna wire. Kinks in the antenna wire will reduce range.
- DO NOT CUT any part of the receiver’s antenna wire. Cutting the antenna will reduce range.
- Extend the antenna wire in the model as far as possible for maximum range. It is not necessary to extend the antenna wire out of the body, but wrapping or coiling the antenna wire should be avoided.
- Do not allow the antenna wire to extend outside the body without the protection of an antenna tube, or the antenna wire may get cut or damaged, reducing range. It is recommended to keep the wire inside the body (in the antenna tube) to prevent the chance of damage.

Your model is equipped with the TQi 2.4GHz transmitter with Traxxas Link™ Model Memory. The transmitter has two channels for controlling your throttle and steering. The receiver inside the model has 5 output channels. Your model is equipped with one servo and an electronic speed control.

TRANSMITTER AND RECEIVER



MODEL WIRING DIAGRAM

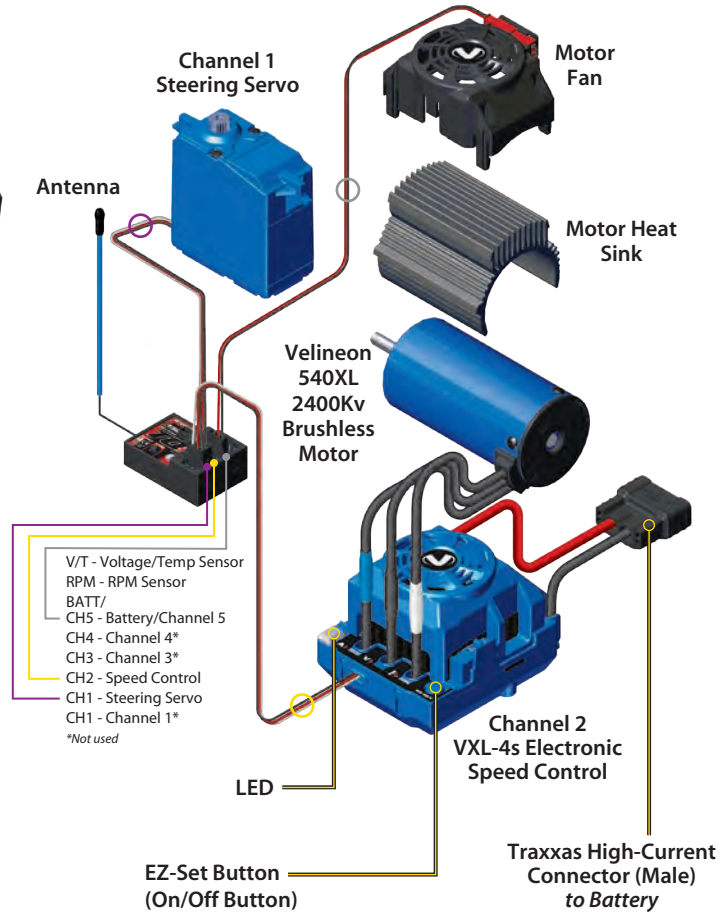

Wiring Diagram

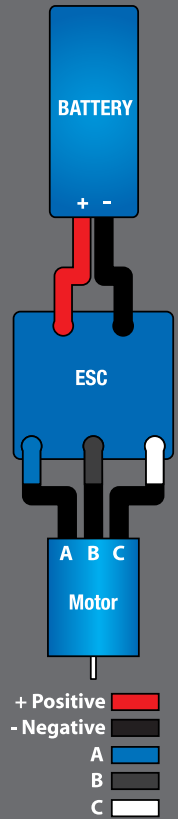

**Accessory sensor expansion port for use with the Telemetry Expander Module (see Traxxas.com and materials included with your model for more information).



If the status LED doesn't light green, check the polarity of the batteries. If you see any other flashing signal from the LED, refer to the chart on page 29 to identify the code.



Use the Right Batteries
Your transmitter uses AA batteries. Use new alkaline batteries (part #2914). Do not use rechargeable AA batteries to power the TQi transmitter, as they will not provide sufficient voltage for optimum transmitter performance.

Caution: Discontinue running your model at the first sign of weak batteries (flashing red light on the transmitter) to avoid losing control.

INSTALLING TRANSMITTER BATTERIES

Your TQi transmitter uses 4 AA batteries. The battery compartment is located in the base of the transmitter.



1. Remove the battery compartment door by pressing the tab and sliding the door open.
2. Install the batteries in the correct orientation as indicated in the battery compartment.
3. Reinstall the battery door and snap it closed.
4. Turn on the transmitter and check the status indicator for a solid green light.

If the status LED flashes red, the transmitter batteries may be weak, discharged or possibly installed incorrectly. Replace with new batteries. The power indicator light does not indicate the charge level of the battery pack installed in the model. Refer to the Troubleshooting section on page 29 for more information on the transmitter Status LED codes.



SELECTING BATTERIES FOR YOUR MODEL

Your model does not include a battery or charger. One Lithium Polymer (LiPo) battery equipped with the Traxxas High Current Connector is required. **Do not use a Nickel Metal Hydride (NiMH) battery.** Traxxas Power Cell iD batteries are strongly recommended for maximum performance and safer charging. The following chart lists available Power Cell iD LiPo batteries for your model:

LiPo Batteries with iD

2872X	5000mAh 11.1v 3-Cell (3s) 25C LiPo Battery*
2857X	6400mAh 11.1v 3-Cell (3s) 25C LiPo Battery**
2889X	5000mAh 14.8v 4-Cell (4s) 25C LiPo Battery**
2890X	6700mAh 14.8v 4-Cell (4s) 25C LiPo Battery

*Requires additional battery pack spacers for proper fitment (part #8919R, sold separately).

**Requires installation of the included battery pack spacers for proper fitment.



WARNING: FIRE HAZARD!

Users of Lithium Polymer (LiPo) batteries must read the Warnings and Precautions beginning on page 4. You **MUST** use a LiPo charger for LiPo batteries or battery damage with the potential for fire will result.

DO NOT use Nickel Metal Hydride (NiMH) batteries with this model. The batteries will become extremely hot and damage or injury could occur.

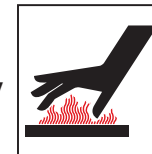

CAUTION

Burn hazard. Hot surface. Do not touch.

SELECTING A CHARGER FOR YOUR MODEL

Make certain you choose the correct type of charger for the batteries you select. Traxxas recommends you choose a genuine Traxxas EZ-Peak iD charger for safer charging and maximum battery life and performance.

Charger	Part No.	NiMH Compatible	LiPo Compatible	Battery iD	Max. Cells
EZ-Peak Plus, 4 amps	2970	YES	YES	YES	3s
EZ-Peak Live, 12 amps	2971	YES	YES	YES	4s
EZ-Peak Dual, 8 amps	2972	YES	YES	YES	3s
EZ-Peak Live Dual, 26+ amps	2973	YES	YES	YES	4s



INSTALLING THE BATTERY PACK

1. Push the battery hold-down toward the center of the truck using the two release tabs and lift the hold-down up and toward you.
2. Insert a fully charged battery into the battery compartment with the High Current Connector positioned toward the rear of the model.
3. Lower the battery hold-down and pull it toward the outside of the truck to snap it closed.

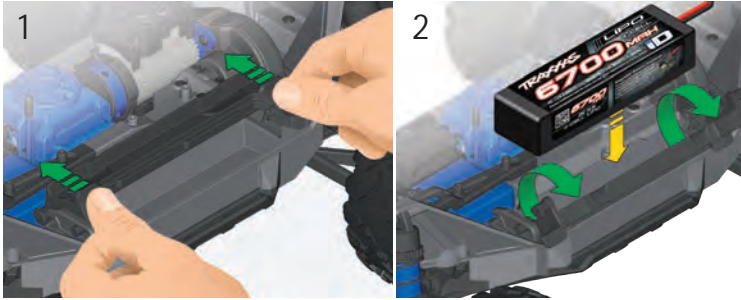

Note: The battery compartment will accommodate the Traxxas 6700mAh 4s battery pack (part #2890X). When using other LiPo batteries, additional foam blocks and battery pack spacers are required for proper fitment (see battery chart on page 12).

RADIO SYSTEM CONTROLS



RADIO SYSTEM RULES

- Always turn your TQi transmitter on first and off last. This procedure will help to prevent your model from receiving stray signals from another transmitter, or other source, and running out of control. Your model has electronic failsafes to prevent this type of malfunction, but the first, best defense against a runaway model is to always turn the transmitter on first, and off last.

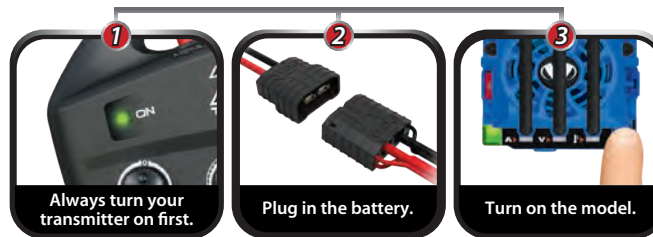

Battery iD

Traxxas recommended battery packs are equipped with Traxxas Battery iD. This exclusive feature allows Traxxas battery chargers (sold separately) to automatically recognize connected battery packs and optimize the charge settings for the battery. This eliminates the need to worry over charger settings and menus for the easiest and safest charging solution possible. Visit Traxxas.com to learn more about this feature and available Traxxas iD chargers and batteries.



The Traxxas High-Current Connector

Your model is equipped with the Traxxas High-Current Connector. Standard connectors restrict current flow and are not capable of delivering the power needed to maximize the output of the VXL-4s. The Traxxas connector's gold-plated terminals, with large contact surfaces, ensure positive current flow with the least amount of resistance. Secure, long-lasting, and easy to grip, the Traxxas connector is engineered to extract all the power your battery has to give.



Remember, always turn the TQi transmitter on first and off last to avoid damage to your model.



Stop immediately at the first sign of weak batteries. Never turn the transmitter off when the battery pack is plugged in. The model could run out of control.

- Always use new batteries for the radio system. Weak batteries will limit the radio signal between the receiver and the transmitter. Loss of the radio signal can cause you to lose control of your model.
- In order for the transmitter and receiver to bind to one another, the receiver in the model must be turned on within 20 seconds of turning on the transmitter. The transmitter LED will flash fast red indicating a failure to link. If you miss it, simply turn off the transmitter and start over.
- Always turn on the transmitter before plugging in the battery.

RADIO SYSTEM BASIC ADJUSTMENTS

Steering Trim

The electronic steering trim located on the face of the transmitter adjusts the neutral (center) point of the steering channel.



Note: Traxxas Stability Management (TSM) must be completely turned off while adjusting steering trim. See page 15 for TSM adjustments.

Multi-Function Knob

The Multi-Function knob can be programmed to control a variety of functions. From the factory, the Multi-Function knob controls Traxxas Stability Management (TSM). For more detail on TSM, refer to page 15.



USING THE RADIO SYSTEM

The TQi Radio System has been pre-adjusted at the factory. The adjustment should be checked before running the model, in case of movement during shipping. Here's how:

1. Turn the transmitter switch on. The status LED on the transmitter should be solid green (not flashing).
2. **Elevate the model on a block or a stand so that all the tires are off the ground.** Make sure your hands are clear of the moving parts of the model.
3. Plug the battery packs in the model into the speed control.
4. The on/off switch is integrated into the speed control. With the transmitter on, press and release the EZ-Set button (.25 seconds). The LED will shine GREEN. This turns the model on. To turn the VXL-4s off, press and hold the EZ-Set button until the LED turns off (.5 seconds).
5. Turn the steering wheel on the transmitter back and forth and check for rapid operation of the steering servo. Also, check that the steering mechanism is not loose or binding. If the steering operates slowly, check for weak batteries.
6. When looking down at model, the front wheels should be pointing straight ahead. If the wheels are turned slightly to the left or right, turn off TSM (see page 15) and slowly adjust the steering trim control on the transmitter until they are pointing straight ahead; then, return the multi-function knob to the desired TSM setting.
7. Gently operate the throttle trigger to ensure that you have forward and reverse operation, and that the motor stops when the throttle trigger is at neutral. **Warning: Do not apply full throttle in forward or reverse while the model is elevated.**
8. Once adjustments are made, turn the model off first (using the switch on the speed control), then turn off the transmitter.



Range-Testing the Radio System

Before each running session with your model, you should range-test your radio system to ensure that it operates properly.

1. Turn on the radio system and check its operation as described in the previous section.
2. Have a friend hold the model. Make sure hands and clothing are clear of the wheels and other moving parts on the model.
3. Walk away from the model with the transmitter until you reach the farthest distance you plan to operate the model.
4. Operate the controls on the transmitter once again to be sure that the model responds correctly.
5. Do not attempt to operate the model if there is any problem with the radio system or any external interference with your radio signal at your location.

Higher Speeds Require Greater Distance

The faster you drive your model, the more quickly it will near the limit of radio range. At 60mph, a model can cover 88 feet every second! It's a thrill, but use caution to keep your model in range. If you want to see your model achieve its maximum speed, it is best to position yourself in the middle of the truck's running area, not the far end, so you drive the truck towards and past your position. In addition to maximizing the radio's range, this technique will keep your model closer to you, making it easier to see and control. **No matter how fast or far you drive your model, always leave adequate space between you, the model, and others. Never drive directly toward yourself or others.**

TQi Binding Instructions

For proper operation, the transmitter and receiver must be electronically 'bound.' **This has been done for you at the factory.** Should you ever need to re-bind the system or bind to an additional transmitter or receiver, follow these instructions. **Note:** The receiver must be connected to a 4.8-6.0v (nominal) power source for binding and the transmitter and receiver must be within 5 feet of each other.

1. Press and hold the transmitter's SET button as you switch the transmitter on. The transmitter's LED will flash red slowly. Release the SET button.
2. Press and hold the receiver's LINK button as you switch on the speed control by pressing the EZ-Set button. Release the LINK button.
3. When the transmitter and receiver's LEDs turn solid green, the system is bound and ready for use. Confirm that the steering and throttle operate properly before driving your model.

TRAXXAS STABILITY MANAGEMENT (TSM)



Traxxas Stability Management® (TSM) lets you experience all the extreme power, speed, and acceleration that was engineered into your Traxxas Maxx®. TSM makes your model much easier to control on slippery surfaces such as loose dirt, smooth concrete, and even ice and snow.

TSM is adjustable to let you optimize performance for different driving surfaces. Out of the box, TSM is set for off-road performance to help you accelerate hard and fast in the dirt and expertly powerslide through the turns. The multi-function knob on your TQi transmitter should be set to the 12:00 position for off-road performance.



When you want to experience all the top speed Maxx has to offer on paved surfaces, turn the multi-function knob counterclockwise to the 9:00 position for greatly enhanced high speed on-road stability and control.



TSM never limits your throttle input or speed.

If you want to experience raw Maxx power without any help from TSM, turn TSM off by setting the multi-function knob on the TQi transmitter to the "0" or off position.



Learn more at Traxxas.com/tsm.

Note: TSM must be completely turned off while adjusting steering trim.



Using Reverse: While driving, push the throttle trigger forward to apply brakes. Once stopped, return the throttle trigger to neutral. Push the throttle trigger forward again to engage proportional reverse.



Automatic Failsafe
The TQi transmitter and receiver are equipped with an automatic failsafe system that does not require user programming. In the event of signal loss or interference, the throttle will return to neutral and the steering will hold its last commanded position. If failsafe activates while you are operating your model, determine the reason for signal loss and resolve the problem before operating your model again.



To prevent loss of radio range do not kink or cut the black wire, do not bend or cut the metal tip, and do not bend or cut the white wire at the end of the metal tip.

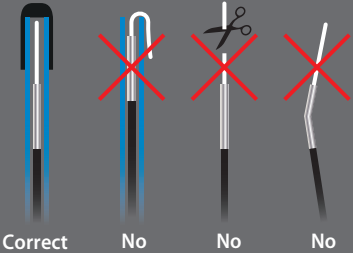

SETTING UP THE ANTENNA

The receiver antenna has been set up and installed from the factory. The antenna is secured by a 3x4mm set screw. To remove the antenna tube, simply remove the set screw with a 1.5mm wrench.

When reinstalling the antenna, first slide the antenna wire into the bottom of the antenna tube until the white tip of the antenna is at the top of the tube under the black cap. Next insert the antenna tube into the mount while making sure that antenna wire is in the slot in the antenna mount, then install the set screw next to the antenna tube. Use a 1.5mm wrench to tighten the screw just until the antenna tube is securely in place. Do not over tighten. **Do not bend or kink the antenna wire! See the sidebar for more information. Do not shorten the antenna tube.**

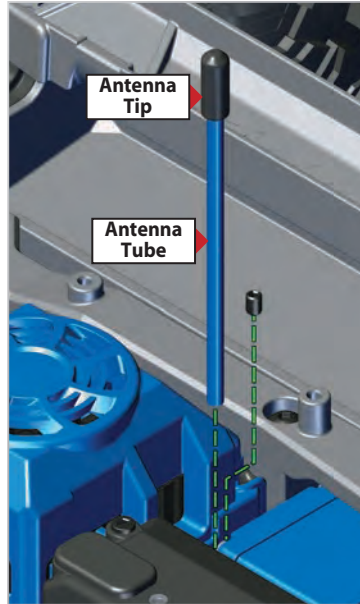

SELF RIGHTING

Your model is equipped with Traxxas Self Righting that will allow you to automatically return it to an upright position after a rollover.* **Make sure there is adequate space around your Maxx and no people or animals are nearby before self righting.** The model moves quickly and the tires are spinning at high speed. If a person or animal approaches the model during self righting, cancel immediately by moving the steering wheel or the throttle trigger. Press and hold the SET button on the transmitter for four (4) seconds to activate the self-righting feature. Once activated, the SET button can be released.

Note: Certain driving surfaces or conditions may prevent the model from uprighting itself. After several attempts, self righting will cancel. Press the SET button to try again, or go and retrieve your model.

**4s LiPo power is recommended for optimal performance.*



ADJUSTING THE ELECTRONIC SPEED CONTROL

Electronic Speed Control Adjustments

The VXL-4s electronic speed control's default settings were programmed at the factory and should not require adjustment for normal operation. The following information is helpful to confirm the settings or allow you to customize the settings for your needs.

ATTENTION: USING LiPo BATTERIES

The VXL-4s electronic speed control is designed to operate on 3s or 4s LiPo battery power. When you turn your model on, the speed control's status LED is green, indicating that **Low Voltage Detection** is activated to prevent over-discharging of LiPo batteries. **LiPo batteries are intended only for the most advanced users that are educated on the risks associated with LiPo battery use.**



WARNING: FIRE HAZARD!

Do not use LiPo batteries in this vehicle with Low-Voltage Detection disabled.

DO NOT use Nickel Metal Hydride (NiMH) batteries with this model. The batteries will become extremely hot and damage or injury could occur.



CAUTION

Burn hazard.
Hot surface.
Do not touch.

Selecting a Throttle Mode: SPORT, RACE, or TRAINING

1. Connect a fully charged battery pack to the VXL-4s and turn on your transmitter.
2. Press and hold the EZ-Set button until the LED turns solid green, then solid red and then begins blinking red. It will blink once, then twice, then three times, then repeat.

One blink = Sport Mode is the default setting. It allows full forward and reverse throttle.

Two blinks = Race Mode removes reverse throttle in case your track does not allow it.

Three blinks = Training Mode will slow the model down by 50% to make it easier for new drivers to control the model.

3. Release the EZ-Set button after the number of blinks for the mode you wish to select. **Note:** *If you missed the mode you wanted, keep the EZ-Set button pressed down and the blink cycle will repeat.*
4. The LED will blink and then turn solid green (Low-Voltage Detection ACTIVE). The model is ready to drive in the mode you have selected.

VXL-4s Setup Programming (calibrating the speed control and transmitter)

The speed control is calibrated at the factory. If the LED on the speed control is flashing green, then follow these steps to recalibrate it (set the throttle to the neutral position).

1. Connect a fully charged battery pack to the VXL-4s.
2. Turn on the transmitter (with the throttle at neutral).
3. Press and hold the EZ-Set button (A). The LED will first turn green and then red. Release the EZ-Set button.
4. When the LED blinks RED ONCE, pull the throttle trigger to the full throttle position and hold it there (B).
5. When the LED blinks RED TWICE, push the throttle trigger to the full reverse and hold it there (C).
6. When the LED blinks GREEN ONCE, programming is complete. The LED will then shine green.

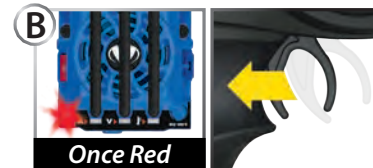

VXL-4s Profile Selection

The speed control is factory set to Profile #1 (100% forward, brakes, and reverse). To disable reverse (Profile #2) or to allow 50% forward and 50% reverse (Profile #3), follow the steps below. The speed control should be connected to the receiver and battery, and the transmitter should be adjusted as described previously. The profiles are selected by entering the programming mode.

Profile Description

Profile #1 (Sport Mode): 100% Forward, 100% Brakes, 100% Reverse

Profile #2 (Race Mode): 100% Forward, 100% Brakes, No Reverse

Profile #3 (Training Mode): 50% Forward, 100% Brakes, 50% Reverse

VXL-4s Specifications

Input voltage:

3s/4s LiPo
(max. 16.8 volts)

Supported Motors:
Sensorless Brushless

Battery connector:
Traxxas High-Current
Connector

Motor connectors:
TRX 6.5mm bullet
connectors

Motor/battery wiring:
10-gauge Maxx® Cable

Weight:
201g (7.1 oz.)

Case size:
59.4mm (2.34")/ 71.5mm
(2.81")/ 49mm (1.93")

Selecting Sport Mode

(Profile #1: 100% Forward, 100% Brakes, 100% Reverse)

1. Connect a fully charged battery pack to the VXL-4s and turn on your transmitter.
2. Press and hold the EZ-Set button until the LED turns solid green, then solid red and then begins blinking red (indicating the Profile numbers).
3. When the LED blinks red once, release the EZ-Set button.
4. The LED will blink and then turn solid green. The model is ready to drive.

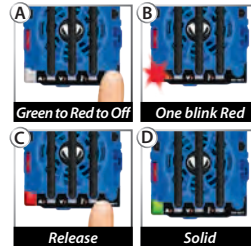

Selecting Race Mode

(Profile #2: 100% Forward, 100% Brakes, No Reverse)

1. Connect a fully charged battery pack to the VXL-4s and turn on your transmitter.
2. Press and hold the EZ-Set button until the LED turns solid green, then solid red and then begins blinking red (indicating the Profile numbers).
3. When the LED blinks red twice, release the EZ-Set button.
4. The LED will blink and then turn solid green. The model is ready to drive.

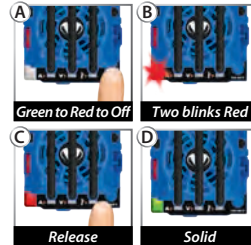

Selecting Training Mode

(Profile #3: 50% Forward, 100% Brakes, 50% Reverse)

1. Connect a fully charged battery pack to the VXL-4s and turn on your transmitter.
2. Press and hold the EZ-Set button until the LED turns solid green, then solid red and then begins blinking red (indicating the Profile numbers).
3. When the LED blinks red three times, release the EZ-Set button.
4. The LED will blink and then turn solid green. The model is ready to drive.

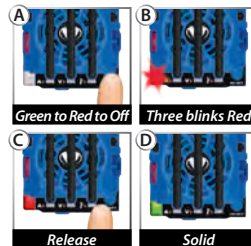

Note: If you missed the mode you wanted, keep the EZ-Set button pressed down and the blink cycle will repeat until the button is released and a mode is selected.

Accessory Power Panel

The VXL-4s electronic speed control is equipped with a power panel that can be used to power optional accessories, such as LED light kits or additional cooling fans (see Traxxas.com for additional information). Always be sure to keep the panel cover installed when accessories are not being used to protect the pins from damage.



LED Codes and Protection Modes

The VXL-4s electronic speed control is equipped with sophisticated circuitry designed to help protect the electronics from damage caused by overloading and excessive temperatures. When a protection circuit is activated, an LED on the VXL-4s ESC will light, indicating a fault.

EZ SET	A	V	F	Explanation	Solution
█	█	□	□	Overcurrent Protection, Stage 1	Stop driving; inspect the vehicle for overgearing or damage.
█	█	□	□	Overcurrent Protection, Stage 2	Stop driving; inspect the vehicle for overgearing or damage.
█	□	█	□	Low Voltage Protection, Stage 1	Stop driving; inspect the battery and recharge.
█	□	█	□	Low Voltage Protection, Stage 2	Stop driving; inspect the battery and recharge.
█	□	█	□	Overvoltage	Stop driving and disconnect the battery. Inspect the battery and confirm the battery voltage.
█	□	□	█	Thermal Shutdown Protection, Stage 1	Stop driving; inspect the cooling fan on the ESC. Allow the power system to cool before continuing.
█	□	□	█	Thermal Shutdown Protection, Stage 2	Stop driving; inspect the cooling fan on the ESC. Allow the power system to cool before continuing.
█	█	█	█	Critical functioning error	Contact Traxxas Customer Service.
█	█	█	█	Programming error	Contact Traxxas Customer Service.



• **Solid Green:** VXL-4s power-on light. Low-Voltage Detection is ACTIVATED (LiPo setting).



• **Current LED (A) Solid Red:** The VXL-4s has entered **Overcurrent Protection, Stage 1**. When excessive current flow (amperage) is being routed through the power system caused by failure to use the appropriate gearing ratio for the drivetrain and the driving surface, the VXL-4s will limit the power output to 50% throttle. Make sure your model is properly geared for the driving conditions. Before continuing, inspect the vehicle for damage. To reset, disconnect and then reconnect the battery.



• **Current LED (A) Fast Blinking Red:** The VXL-4s has entered **Overcurrent Protection, Stage 2**. When the current flow (amperage) spikes temporarily due to a bound or restricted driveline (model is stuck against an object or encountered a restrictive driving surface), the VXL-4s will automatically shut down (fail-safe mode). Stop driving the vehicle. The VXL-4s will stay in this mode until the current flow is recovered (obstruction is removed, model is moved to a smoother driving surface) and the throttle is returned to neutral. Also, if the motor becomes damaged during driving, the VXL-4s will enter this mode any time the throttle is applied.



• **Voltage LED (V) Solid Red:** The VXL-4s has entered **Low Voltage Protection, Stage 1**. When the battery voltage begins to reach the minimum recommended discharge voltage threshold for LiPo battery packs, the VXL-4s will limit the power output to 50% throttle. Stop driving the model. The VXL-4s will stay in this mode until the battery voltage is recovered or a fully charged battery is connected.



• **Voltage LED (V) Slow Blinking Red:** The VXL-4s has entered **Low Voltage Protection, Stage 2**. When the battery voltage attempts to fall below the minimum threshold, the VXL-4s will automatically shut down (fail-safe mode). The LED on the speed control will slowly blink red, indicating a low-voltage shutdown. Stop driving the model. The VXL-4s will stay in this mode until a fully charged battery is connected.



• **Voltage LED (V) Fast Blinking Red:** If the motor has no power, the VXL-4s has entered **Overvoltage Protection**. If the battery voltage from the connected battery packs is too high, the VXL-4s will go into a fail-safe mode. **WARNING:** If input voltage exceeds approximately 16.8 maximum peak input voltage, the ESC may be damaged. Do not exceed 16.8 maximum total peak voltage. Stop driving the model and disconnect the battery.



• **Temperature LED (F) Solid Red:** The VXL-4s has entered **Thermal Shutdown Protection, Stage 1** to guard against overheating caused by excessive current flow. The VXL-4s will limit the power output to 50% throttle. Stop driving the model. Inspect the cooling fan on the ESC to make sure it is operating. Allow the power system to cool before continuing.



• **Temperature LED (F) Fast Blinking Red:** The VXL-4s has entered **Thermal Shutdown, Protection Stage 2** and has automatically shut down (fail-safe mode). Stop driving the model. Inspect the cooling fan on the ESC to make sure it is operating. Allow the power system to cool before continuing. If you are experiencing frequent warnings about temperature, it could be caused by overgearing (from stock), overly aggressive and continuous high speed driving, vehicle damage, or driving in conditions such as deep sand, heavy mud, and tall grass.



• **Current/Voltage/Temperature LEDs Solid Red or all LEDs Fast Blinking Red:** The VXL-4s has entered this protection mode due to possibly having Thermal Shutdown Protection and Low Voltage Protection (see above) occur at the same time or there is a critical functioning or programming error. Disconnect the battery and contact Traxxas Customer Service for assistance.



DRIVING YOUR MODEL

Now it's time to have some fun! This section contains instructions on driving and making adjustments to your model. Before you go on, here are some important precautions to keep in mind.

- Allow the model to cool for a few minutes between runs. This is particularly important when using high capacity battery packs that allow extended periods of running. Monitoring temperatures will extend the lives of the batteries and motors.
- Do not continue to operate the model with low batteries or you could lose control of it. Indications of low battery power include slow operation and sluggish servos (slow to return to center). Stop immediately at the first sign of weak batteries. When the batteries in the transmitter become weak, the red power light will begin to flash. Stop immediately and install new batteries.
- Do not drive the model at night, on public streets, or in large crowds of people.
- If the model becomes stuck against an object, do not continue to run the motors. Remove the obstruction before continuing. Do not push or pull objects with the model.
- Because the model is controlled by radio, it is subject to radio interference from many sources beyond your control. Since radio interference can cause momentary losses of control, allow a safety margin of space in all directions around the model in order to prevent collisions.
- Use good, common sense whenever you are driving your model. Intentionally driving in an abusive and rough manner will only result in poor performance and broken parts. Take care of your model so that you can enjoy it for a long time to come.
- High performance vehicles produce small vibrations which may loosen hardware over time. Frequently check wheel nuts and other screws on your vehicle to ensure that all hardware remains properly tightened.

About Run Time

A large factor affecting run time is the type and condition of your batteries. The milliamp hour (mAh) rating of the batteries determines how large their "fuel tank" is. A 3000mAh battery pack will theoretically run twice as long as a 1500mAh sport pack. Because of the wide variation in the types of batteries that are available and the methods with which they can be charged, it's impossible to give exact run times for the model.

Another major factor that affects run time is how the model is driven. Run times may decrease when the model is driven repetitively from a stop to top speed and with repetitive hard acceleration.

Tips for Increasing Run Time

- Use batteries with the highest mAh rating you can purchase.
- Use a high-quality peak-detecting charger.
- Read and follow all maintenance and care instructions provided by the manufacturer of your batteries and charger.
- Keep the VXL-4s cool. Get plenty of airflow across the ESC.
- Lower your gear ratio. Installing smaller pinion gears will lower your gear ratio and cause less power draw from the motor and batteries, and reduce overall operating temperatures. Always replace the pinion and spur gears together.
- Vary your speed. Continuous high-speed, high-gear running shortens the run time on the Maxx.
- Maintain your model. Do not allow dirt or damaged parts to cause binding in the drivetrain. Keep the motor clean.

mAh Ratings and Power Output

The mAh rating of the battery can effect your top-speed performance. The higher capacity battery packs experience less voltage drop under heavy load than low mAh rated packs. The higher voltage potential allows increased speed until the battery begins to become discharged.

RUNNING IN WET CONDITIONS

Your new Traxxas model is designed with water-resistant features to protect the electronics in the model (receiver, servo, electronic speed control). This gives you the freedom to have fun driving your model through puddles, wet grass, snow, and through other wet conditions. Though highly water resistant, the model should not be treated as though it is submersible or totally 100% waterproof. Water resistance applies only to the installed electronic components. Running in wet conditions requires additional care and maintenance for the mechanical and electrical components to prevent corrosion of metal parts and maintain their proper function.

Precautions

- **Without proper care, some parts of your model can be seriously damaged due to contact with water. Know that additional maintenance procedures will be required after running in wet conditions in order to maintain the performance of your model. Do not run your model in wet conditions if you are not willing to accept the additional care and maintenance responsibilities.**

- **Not all batteries can be used in wet environments.** Consult your battery manufacturer to see if their batteries can be used in wet conditions.
- The Traxxas TQi transmitter is not water resistant. Do not subject it to wet conditions such as rain.
- Do not operate your model during a rain storm or other inclement weather where lightning may be present.
- Do NOT allow your model to come in contact with salt water (ocean water), brackish water (between fresh water and ocean water), or other contaminated water. Salt water is highly conductive and highly corrosive. Use caution if you plan to run your model on or near a beach.

Before Running Your Vehicle in Wet Conditions

1. Consult the section “After Running Your Vehicle in Wet Conditions” before proceeding. Make sure you understand the additional maintenance required with wet running.
2. The wheels have small holes molded in to allow air to enter and exit the tire during normal running. Water will enter these holes and get trapped inside the tires if holes are not cut in the tires. Cut two small holes (3mm or 1/8” diameter) in each tire. Each hole should be near the tire center-line, 180° apart.
3. Confirm that the receiver box O-ring and cover are installed correctly and secure. Make sure the screws are tight and the blue O-ring is not visibly protruding from the edge of the cover.
4. Confirm that your batteries can be used in wet conditions.
5. Use lower gearing (smaller pinion gears, as low as 16T or spur gear as large as 54T) when running in mud, deep puddles, snow, or other similar situations that will restrict the tires and put much higher loads on the motor.

Note: To prevent damage to your vehicle’s electronics while running in soft sand, make these minor modifications to all four wheel and tire assemblies. Pinch the tire as you cut two small slits using body scissors. Cut the slits in a “V” pattern; then, remove the cut material for an approximately 3mm or 1/8” diameter hole. Repeat on the opposite side of the tire (180° apart). Cover the two breather holes in the wheel with adhesive tape.

Motor Precautions

- Motor life can be greatly reduced in mud and water. If the motor gets excessively wet or submerged, use very light throttle (run the motor slowly) until the excess water can run out. Applying full

throttle to a motor full of water can cause rapid motor failure. Your driving habits will determine motor life with a wet motor. Do not submerge the motor under water.

- Do not gear the motor by temperature when running in wet conditions. The motor will be cooled by water contact and will not give an accurate indication of appropriate gearing.
- Use special care when operating your model in muddy conditions. Stop operating your model if it appears to be straining due to the tackiness of the mud or build-up of mud on the chassis. Do not allow mud to collect on the motor or pack around the motor.

After Running Your Vehicle in Wet Conditions

1. Drain the tires by spinning the tires at high speed to “sling” the water out. One way to do this is to make several high-speed passes on a flat, dry surface, if possible.
2. Remove the battery.
3. Rinse excess dirt and mud off the truck with low-pressure water, such as from a garden hose. Do NOT use a pressure washer or other high pressure water. Avoid directing water into the bearings, differentials, etc.
4. Blow off the truck with compressed air (optional, but recommended). Wear safety glasses when using compressed air.
5. Remove the wheels from the truck.
6. Spray all the bearings, drivetrain, and fasteners with WD-40® or similar water displacing light oil.
7. Let the truck stand or you may blow it off with compressed air. Placing the truck in a warm, sunny spot will aid drying. Trapped water and oil will continue to drip from the truck for a few hours. Place it on a towel or piece of cardboard to protect the surface underneath.
8. As a precautionary step, remove the sealed receiver box cover. While unlikely, humidity or tiny amounts of moisture or condensation may enter the receiver box during wet running. This can cause long-term problems with the sensitive electronics in the receiver. Removing the receiver box cover during storage allows the air inside to dry. This step can improve the long-term reliability of the receiver. It is not necessary to remove the receiver or unplug any of the wires.

9. **Additional Maintenance:** Increase your frequency of disassembly, inspection, and lubrication of the following items. This is necessary after extended wet use or if the vehicle will not be used for an extended period of time (such as a week or longer). This additional maintenance is needed to prevent any trapped moisture from corroding internal steel components.

- **Stub axle housing and center driveline bearings:** Remove, clean, and re-oil the bearings.
- **Differentials:** Remove, disassemble, clean, and re-grease the differential components. Use a light coating of Traxxas high-performance grease (part #5041) on the metal gear teeth. Refer to your exploded view diagrams for help with disassembly and reassembly.
- **Motor:** After operating your model in wet or muddy conditions, remove the motor and clean any mud or dirt from the bearings. To prevent corrosion and ensure maximum bearing life, lubricate the bearings with a light oil (available at your local hobby store). Following these steps will extend motor life and maintain peak performance. **Be sure to wear eye protection when using spray aerosol cleaners.**

RECEIVER BOX: MAINTAINING A WATERTIGHT SEAL

Removing and Installing Radio Gear

The unique design of the receiver box allows the removal and installation of the receiver without losing the ability to maintain a watertight seal in the box. The patented wire clamp feature gives you the ability to also install aftermarket radio systems and maintain the watertight features of the receiver box.

Removing the Receiver

1. To remove the cover, remove the three 3x10mm cap screws.
2. To remove the receiver from the box, simply lift it out and set to the side. The antenna wire is still inside the clamp area and cannot be removed yet.
3. Remove the wire clamp by removing the two 2.5x10mm cap screws.
4. Unplug the servo cables from the receiver and remove the receiver.

Receiver Installation

1. Always install the wires into the box before installing the receiver.
2. Install the antenna wire and the servo cables into the receiver box.
3. Arrange the wires neatly using the wire guides in the receiver box. The excess wire will be bundled inside the receiver box. Label which wire is for which channel.
4. Apply a small bead of silicone grease (Traxxas part #1647) to the wire clamp.
5. Install the wire clamp and tighten the two 2.5x10mm cap screws securely.
6. Using double-sided adhesive foam tape, install the receiver into the box.

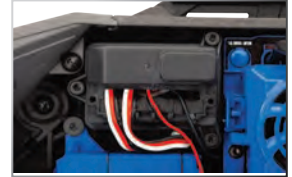

Note: For best performance, it is recommended that the receiver be installed in the original orientation as shown.



7. Plug the wires into the receiver. Refer to page 11 for the wiring diagram.
8. Make sure the box light pipe is aligned with the receiver LED. Make sure the O-ring is properly seated into the groove in the receiver box so that the cover will not pinch it or damage it in any way.
9. Install the cover and tighten the three 3x10mm cap screws securely.
10. Inspect the cover to make sure that the O-ring seal is not visible.



BASIC TUNING ADJUSTMENTS

Once you become familiar with driving your model, you might need to make adjustments for better driving performance.

SUSPENSION TUNING

Shock Mounting Positions

Big bumps and rough terrain require a softer suspension with the maximum possible suspension travel and lower height. Racing on a prepared track or on-road use requires a lower ride height and firmer, more aggressive suspension settings.

The suspension of your model has been set up for off-road performance (position 1 on the front and rear suspension arms). If you plan on driving on hard surfaces, move all four shocks to position 2 on the suspension arms.



Fine Tuning the Shocks

The four GT-Maxx® shocks greatly influence handling. Periodic maintenance may be required to maintain optimal performance. You can also tune your shocks to your driving style or running environment. Whenever you rebuild shocks, or make any changes to the pistons, springs, or oil, always make changes to the shocks in pairs (front or rear).

To disassemble the GT-Maxx shocks:

1. Remove the 2.5x12mm cap screw from the lower spring retainer. Remove the lower spring retainer and shock spring.
2. Remove the cartridge/shock shaft/piston assembly from the shock body.

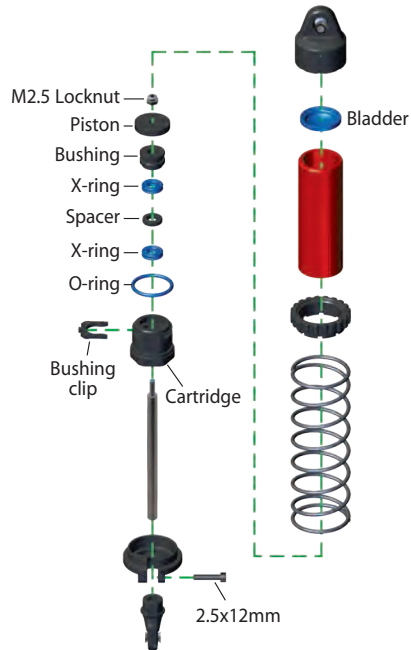

3. Remove the M2.5 locknut, piston, 2.5x5mm washer, and the existing cartridge assembly from the shock shaft.

Note: The holes in the front and rear pistons are different sizes. Be sure to use the correct pistons for the front and rear shocks during disassembly/assembly (see sidebar for more information).

4. Assemble the new cartridge on the shock shaft.

Note: The new cartridge must be assembled on the shock shaft. DO NOT attempt to assemble the cartridge separately and slide it onto the shaft. This may damage the shaft x-rings and cause a leak.

5. Reassemble in reverse order. Be sure to fill the shocks with 100% pure silicone shock oil to help prolong the life of the seals. From the factory, the GT-Maxx shocks are filled with 60W shock oil. When adding shock fluid, be sure to allow any air bubbles to escape.

You can tune your shocks by using thicker or thinner viscosity shock oil, as well as changing the piston that moves through the fluid inside the shock.

Ride height can be adjusted by using the threaded spring retainer. Adjust the ride height so that the suspension arms are just slightly above being parallel to the ground. Observe how Maxx handles in turns. Proper setup will add stability and help prevent spinouts. Experiment with different shock oils and ride heights to find what works best for your driving style and conditions.

WHEELS AND TIRES

Many types of aftermarket tires and wheels can be adapted for use on your model. Most will affect the overall width and the suspension geometry of the model. The offsets and dimensions designed into the model's wheels are intentional; therefore, Traxxas cannot recommend the use of other non-Traxxas wheels with different specifications. The diameter of the wheels is an innovative design, and there is a variety of different tires available for you to experiment with in addition to the included tires on the model (listed in your parts list). Experimentation with different types of tires is recommended to see which ones work the best on the terrain where the model is run. When selecting tires, consider the overall diameter and the rubber compound (hard or soft). If the overall diameter of the tire is significantly increased, you will need to use a smaller pinion gear to compensate for the larger tire. Soft compound tires with many short spikes generally work better on hard, dry surfaces. In loose dirt, a tire with large spikes should perform better. See your parts list for accessory wheels and tires.



Important: The shocks are assembled at the factory with a center-to-center distance (between the rod end balls) of 129.2mm. Any time the shocks are removed and disassembled, this distance should be checked to ensure proper operation of the suspension.

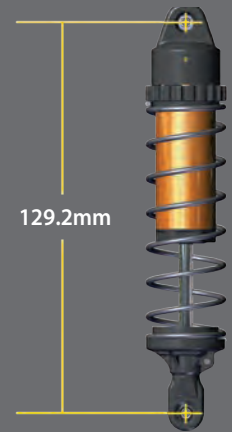

Shock Piston Sizes

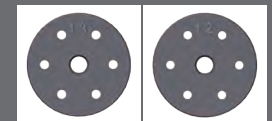

1.35mm Front 1.25mm Rear

Gearing Compatibility Chart:

The chart below shows recommended gear combination ranges for your model.

		Spur Gear		
		46	50	54
Pinion Gear	16	-	-	3.38
	17	-	-	3.18
	18	-	-	3.00
	19	-	-	2.84
	20	-	2.50	2.70
	21	-	2.38	2.57
	22	-	2.27	2.45
	23	-	2.17	-
	24	1.92	2.08	-
	25	1.84	2.00	-
	26	1.77	-	-
27	1.70	-	-	

- Out of Box Setup; recommended for most running, 3s/4s LiPo. 3s 4000mAh + recommended 4s 5000mAh + recommended
- Usable gearing range for 3s/4s LiPo. Increases torque and run time. 3s 4000mAh + recommended 4s 5000mAh + recommended
- Usable gearing range for 3s/4s LiPo for high speed runs on hard smooth surfaces only. 3s 4000mAh + recommended 4s 5000mAh + recommended
- High speed gearing for 3s/4s LiPo, high speed runs (60+mph) on hard smooth surfaces only. 3s 4000mAh + recommended 4s 5000mAh + recommended
- Fits; not recommended for use.
- Does not fit.

MOTORS AND GEARING

One of the more significant advantages to your model's transmission is the wide range of available gear ratios. Changing the gearing allows you to fine tune the speed of the model and control the temperatures of the battery pack and motor. Use a lower gear ratio (numerically larger) to reduce current draw and temperatures. Use a higher gear (numerically lower) to increase top speed. Use the following formula to calculate the overall ratio for combinations not listed on the gear chart:

$$\frac{\text{\# Spur Gear Teeth}}{\text{\# Pinion Gear Teeth}} \times 5.69 = \text{Final Gear Ratio}$$

When using higher gear ratios, it is important to monitor the temperatures of the battery, motor, and speed control. If the battery is extremely hot (150°F) and/or the motor is too hot to touch (200°F), your model is probably over-gearred and drawing too much current. This temperature test assumes that the model is close to factory stock weight and operates freely with no excessive friction, dragging, or binding, and the battery is fully charged and in good condition. **Note:** If not using the pin system, check and adjust gear mesh if a spur and/or pinion gear is changed.

This model is equipped with a Velineon 540XL 2400Kv brushless motor. The gear combination that comes stock on each model provides good overall acceleration and top speed. If you want more top speed and less acceleration, install optional high speed gearing (more teeth). If you want more acceleration and less top speed, use a smaller optional pinion gear. **Optional gearing not included.**

Note: High speed gearing is intended for high-speed running on hard surfaces and is not recommended for off-road or repetitive starting and stopping. For this type of driving, smaller pinion gears are recommended to reduce load on the motor.

Adjusting Gear Mesh

Incorrect gear mesh is the most common cause of stripped spur gears. Maxx makes improper gear mesh virtually impossible. A pin system helps set the motor in the proper place according to the pinion and spur gear that are selected.

To access the pin system, remove the single 4x8mm button-head cap screw from the motor plate and the two 4x12mm button-head cap screws from the bottom of the chassis. Next, remove the two 3x10mm cap screws that secure the gear cover and remove the gear cover. Lift off the motor to expose the pin that goes between the motor and the chassis. **Be sure not to lose this pin!**

Select the desired gearing from the pin location chart. Replace the spur and pinion gears as needed. When installing the motor, install the pin into its proper location based on the gearing that is chosen. Secure the motor in place with the two 4x12mm button-head cap screws inserted from the bottom of the chassis, and then the single 4x8mm button-head screw in the motor plate.





		Spur Gear		
		46	50	54
Pinion Gear	16	-	-	A
	17	-	-	B
	18	-	-	C
	19	-	-	D
	20	-	A	E
	21	-	B	F
	22	-	C	H
	23	-	D	-
	24	A	E	-
	25	B	F	-
	26	C	-	-
27	D	-	-	

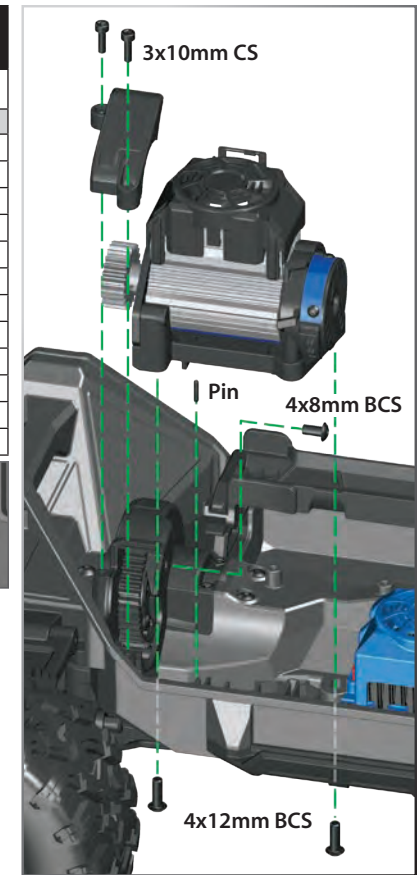

Note: Should you choose to do so, you can also set the gear mesh manually without the pin. With the pin removed, use the two 4x12mm button-head cap screws on the bottom of the chassis to set gear mesh. Loosen the two 4x12mm button-head cap screws.

Cut a narrow strip of notebook paper and run it into the gear mesh. Slide the motor and pinion gear into the spur gear. Tighten the two 4x12mm button-head cap screws, and then remove the strip of paper. You should be able to run a fresh strip of paper through the gears without binding them.



 EXTREME BRUSHLESS POWER SYSTEM		Your Battery Selection and Pinion/Spur Selection Determines Your Speed. How Fast Do You Want To Go?			
		FUN ZONE		TOP SPEED ZONE	
Speed	40+mph	45mph	55+mph	60+mph	
Pinion/Spur	23/50*	25/46**	23/50*	25/46**	
Battery	3S LiPo	3S LiPo	4S LiPo	4S LiPo	
Nominal Voltage	11.1V	11.1V	14.8V	14.8V	
mAh	5000+ mAh	5000+ mAh	6700+ mAh	6700+ mAh	
Skill Level					

*Stock gearing
**Optional gearing (sold separately)

TEMPERATURES AND COOLING

The Maxx includes several features to help cool the electronic components. A cooling fan and heat sink help pull the heat away from the Velineon 540XL 2400Kv motor. An electronic speed control cooling fan assists in cooling the VXL-4s in high-current motor applications.

TUNING THE SEALED GEAR DIFFERENTIALS

Maxx's front and rear gear differentials allow the left and right wheels to spin at different speeds while turning so that the tires do not scuff or skid. This decreases the turning radius and increases steering performance.

The performance of the differentials can be tuned for different driving conditions and performance requirements. The differentials are filled with silicone differential fluid, and are sealed to maintain consistent long-term performance. Changing the oil in the differential with either lower or higher viscosity oil will vary the performance characteristics of the differentials. Changing to a higher viscosity oil in the differential will reduce the tendency for engine power to be transferred to the wheel with the least traction. You may notice this when making sharp turns on slick surfaces. The unloaded wheels on the inside of the turn have the least traction and tend to spin up to extremely high rpms. Higher viscosity (thicker) oil causes the differential to act like a limited-slip differential, distributing more equal power to the left and right wheels. Maxx will generally benefit from higher viscosity oil when climbing, rock crawling, or racing on low traction surfaces.

Note: Heavier oil will allow power to be transferred even with one or more tires off the ground. This can make the vehicle more likely to overturn.

From the factory, both the differentials are filled with SAE 50,000W viscosity silicone oil. Only use silicone oil in the differentials. Traxxas sells SAE 10,000W, SAE 30,000W, SAE 100,000W, and SAE 500,000W viscosity oil (see your parts list). The differentials have to be removed from the vehicle and disassembled to change/replace oil. Use the exploded views included with your model to aid in the disassembly/assembly process.

CENTERING YOUR SERVO

If you have removed the servo horn from your Maxx's steering servo, or the servo has been removed for service or cleaning, the servo must be re-centered prior to installation of the servo horn or installation of the servo.

1. Remove the servo horn from the steering servo.
2. Connect the steering servo to channel 1 on the receiver. Connect the electronic speed control (ESC) to channel 2. The white wire on the servo lead is positioned toward the receiver's LED.
3. Turn the transmitter power switch on. Make certain the transmitter's batteries are not depleted.
4. Turn off TSM (see page 15).
5. Turn the transmitter's steering trim knob to the center "0" position.
6. Disconnect both the blue and white motor connectors (see page 11) to prevent the motor from turning during the next steps. Connect a fresh battery pack to the speed control and turn on the ESC (see page 17). The servo's output shaft will automatically jump to its center position.
7. Install the servo horn onto the servo output shaft. With the servo laying down flat, the servo horn should be installed vertically so that it is in the centered position.
8. Check servo operation by turning the steering wheel back and forth to ensure that the mechanism has been centered properly and you have equal throw in both directions. Use the transmitter's steering trim knob to fine-tune the position of the servo horn so the model tracks straight when the steering wheel is at neutral.

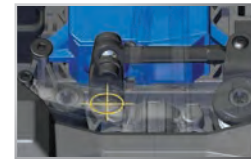



Always wear eye protection when using compressed air or spray cleaners and lubricants.

Your model requires timely maintenance in order to stay in top running condition. **The following procedures should be taken very seriously.**

Frequently inspect the vehicle for obvious damage or wear.

Look for:

1. Cracked, bent, or damaged parts
2. Check the wheels and steering for binding.
3. Check the operation of the shock absorbers.
4. Check the wiring for any frayed wires or loose connections.
5. Check the mounting of the receiver and servo(s) and speed control.
6. Check the tightness of the wheel nuts with a wrench.
7. Check the operation of the radio system, especially the condition of the batteries.
8. Check for any loose screws in the chassis structure or suspension.
9. Check the operation of the steering servo and ensure that it is not binding.
10. Inspect the gears for wear, broken teeth, or debris lodged between the teeth.

Other periodic maintenance:

- **Cush Drive:** The cush drive system does not require maintenance, but should be inspected periodically. If the Cush Drive develops play (spur gear movement that does not also move the drive shaft), disassemble the cush drive and inspect the elastomer element (part #6465) for damage and replace if necessary.
- **Chassis:** Be sure to keep the motor and ESC free of grass, dirt and grime to be sure to keep the components cool for optimal run times and temperatures.
- **Suspension:** Periodically inspect the model for signs of damage, such as bent or dirty suspension pins, damaged toe links, loose screws, and any signs of stress or bending. Replace components as needed.

- **Steering:** Over time, you may notice increased looseness in the steering system. The toe links may wear out from use (part #8948). Replace these components as needed to restore factory tolerances.

- **Shocks:** Keep the oil level in the shocks full. Use only 100% pure silicone shock oil to prolong the life of the seals. If you are experiencing leakage around the top of the shock, inspect the bladder in the top cap for signs of damage or distortion from overtightening. If the bottom of the shock is leaking, then it is time for a rebuild. The Traxxas rebuild kit for two shocks is part #8962.

- **Driveline:** Inspect the driveshafts to ensure that all components are free of debris. Additional driveline noise can occur if the driveline components are dirty. Remove the gear cover. Inspect the spur gear for wear and check the tightness of the set screws in the pinion gears. Tighten, clean, or replace components as needed.

- **Torque-biasing center drive unit:** The Maxx is equipped with a torque-biasing center drive unit. The drive unit can be rebuilt, but it requires a detailed maintenance procedure and the use of 20MM weight differential oil (part #5040). For additional information and how-to videos, please visit Traxxas.com.

Storage

When you are through running the model for the day, blow it off with compressed air or use a soft bristled paint brush to dust off the vehicle. Always disconnect and remove the battery from the model whenever the model is stored. If the model will be stored for a long time, also remove the batteries from the transmitter.

Removing the front suspension module

1. Remove the two 4x20mm countersunk cap screws from the front skidplate on the bottom of the chassis.
2. Remove the 3x15mm button-head cap screw from the steering link.
3. Remove the seven 4x12mm button-head cap screws from the chassis brace (1), front shock tower (2), and chassis (4).
4. Pull the front suspension assembly away from the chassis. Pull the assembly away firmly.

To reassemble the modules, follow the steps in reverse order.

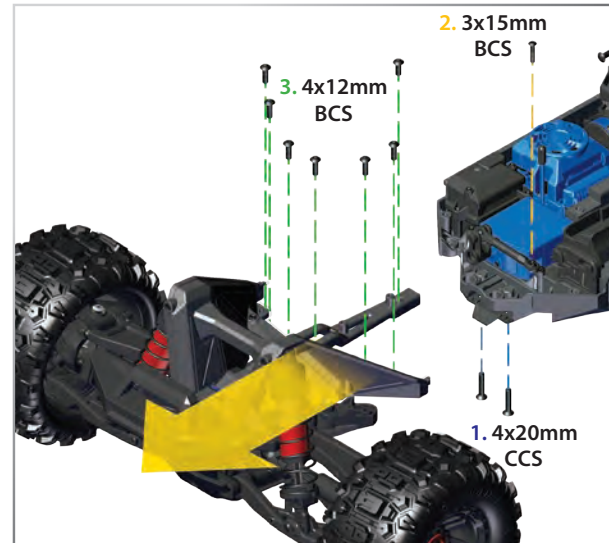

Removing the rear suspension module

1. Remove the two 4x20mm countersunk cap screws from the center skidplate on the bottom of the chassis.
2. Remove the two 4x12mm button-head cap screws that secure the rear bulkhead to the bottom of the chassis.
3. Remove the two 3x10mm cap screws from the gear cover. Remove the gear cover.
4. Remove the 4x8mm button-head cap screw from the motor plate.
5. Remove the two 4x12mm button-head cap screws from the rear shock tower.
6. Remove the two 4x22mm button-head cap screws that secure the rear bulkhead to the top of the chassis.
7. Pull the rear suspension assembly away from the chassis. Pull the assembly away firmly.

To reassemble the modules, follow the steps in reverse order.

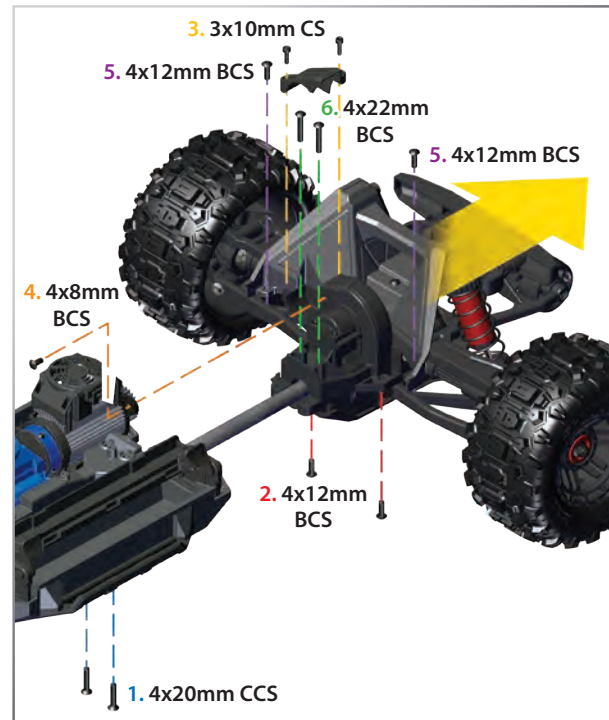

Starting Over:

Restoring Factory Defaults

When programming your TQi transmitter, you may feel the need to start over with a clean slate. Follow these simple steps to restore the factory settings:

1. Turn the transmitter off.
2. Hold both MENU and SET.
3. Turn the transmitter on.
4. Release MENU and SET.

The transmitter LED will blink red.

5. Press SET to clear settings.

The LED will turn solid green and the transmitter is restored to default.

Throttle Trim Seek Mode

When the Multi-Function knob is set to throttle trim, the transmitter remembers the throttle trim setting. If the throttle trim knob is moved from the original setting while the transmitter is off, or while the transmitter was used to control another model, the transmitter ignores the actual position of the trim knob. This prevents the model from accidentally running away. The LED on the face of the transmitter will rapidly blink green and the throttle trim knob (Multi-Function knob) will not adjust the trim until it is moved back to its original position saved in memory. To restore throttle trim control, simply turn the Multi-Function knob either direction until the LED stops blinking.

Your Traxxas transmitter has a programmable Multi-Function knob that can be set to control various advanced transmitter functions (set to Traxxas Stability Management (TSM) by default, see page 15). Accessing the programming menu is done by using the menu and set buttons on the transmitter and observing signals from the LED. An explanation of the menu structure follows on page 31. Experiment with the settings and features to see if they can improve your driving experience.

Steering Sensitivity (Exponential)

The Multi-Function knob on the TQi transmitter can be set to control Steering Sensitivity (also known as exponential). The standard setting for Steering Sensitivity is “normal (zero exponential),” with the dial full left in its range of travel. This setting provides linear servo response: the steering servo’s movement will correspond exactly with the input from the transmitter’s steering wheel. Turning the knob clockwise from center will result in “negative exponential” and decrease steering sensitivity by making the servo less responsive near neutral, with increasing sensitivity as the servo nears the limits of its travel range. The farther you turn the knob, the more pronounced the change in steering servo movement will be. The term “exponential” comes from this effect; the servo’s travel changes exponentially relative to the input from the steering wheel. The exponential effect is indicated as a percentage—the greater the percentage, the greater the effect. The illustrations below show how this works.

Normal Steering Sensitivity (0% exponential):

In this illustration, the steering servo’s travel (and with it, the steering motion of the model’s front wheels) corresponds precisely with the steering wheel. The ranges are exaggerated for illustrative purposes.

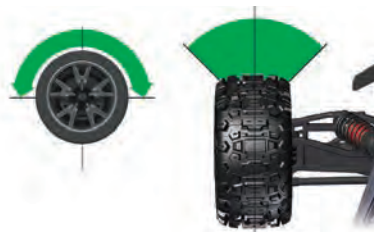

Decreased Steering Sensitivity (Negative Exponential):

By turning the Multi-Function knob clockwise, the steering sensitivity of the model will be decreased. Note that a relatively large amount of steering wheel travel results in a smaller amount of servo travel. The farther you turn the knob, the more pronounced the effect becomes. Decreased steering sensitivity may be helpful when driving on low-traction surfaces, when driving at high speed, or on tracks that favor sweeping turns where gentle steering inputs are required. The ranges are exaggerated for illustrative purposes.

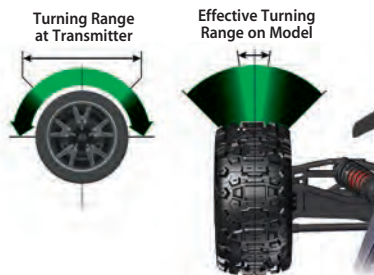

Throttle Sensitivity (Throttle Exponential)

The Multi-Function knob can be set to control Throttle Sensitivity. Throttle Sensitivity works the same way as Steering Sensitivity, but applies the effect to the throttle channel. Only forward throttle is affected; brake/reverse travel remains linear regardless of the Throttle Sensitivity setting.

Steering Percentage (Dual-Rate)

The Multi-Function knob can be set to control the amount (percentage) of servo travel applied to steering. Turning the Multi-Function knob fully clockwise will deliver maximum steering throw; turning the knob counterclockwise reduces steering throw (**Note:** Turning the dial counterclockwise to its stop will eliminate all servo travel). Be aware that the steering End Point settings define the servo’s maximum steering throw. If you set Steering Percentage to 100% (by turning the Multi-Function knob fully clockwise), the servo will travel all the way to its selected end point, but not past it. Many racers set Dual-Rate so they have only as much steering throw as they need for the track’s tightest turn, thus making the model easier to drive throughout the rest of the course. Reducing steering throw can also be useful in making a model easier to control on high-traction surfaces, and limiting steering output for oval racing where large amounts of steering travel are not required.

Braking Percentage

The Multi-Function knob may also be set to control the amount of brake travel applied by the servo in a nitro-powered model. Electric models do not have a servo-operated brake, but the Braking Percentage function still operates the same way in electric models. Turning the Multi-Function knob full clockwise will deliver maximum brake throw; turning the knob counterclockwise reduces brake throw (**Note:** Turning the dial counterclockwise to its stop will eliminate all brake action).

Throttle Trim

Setting the Multi-Function knob to serve as throttle trim will allow you to adjust the throttle’s neutral position to prevent unwanted brake drag or throttle application when the transmitter trigger is at neutral. **Note:** Your transmitter is equipped with a Throttle Trim Seek mode to prevent accidental runaways. See the sidebar for more information.

Steering and Throttle End Points

The TQi transmitter allows you to choose the limit of the servo's travel range (or its "end point") independently for left and right travel (on the steering channel) and throttle/brake travel (on the throttle channel). This allows you to fine-tune the servo settings to prevent binding caused by the servo moving steering or throttle linkages (in the case of a nitro model) farther than their mechanical limits. The end point adjustment settings you select will represent what you wish to be the servo's maximum travel; the Steering Percentage or Braking Percentage functions will not override the End Point settings.

Steering and Throttle Sub-Trim

The Sub-Trim function is used to precisely set the neutral point of the steering or throttle servo in the event that simply setting the trim knob to "zero" does not completely center the servo. When selected, Sub-Trim allows finer adjustment to the servo output shaft's position for precise setting of the neutral point. Always set the Steering Trim knob to zero before making final adjustment (if required) using Sub-Trim. If Throttle Trim has been previously adjusted, the Throttle Trim will need to be reprogrammed to "zero" before making final adjustment using Sub-Trim.

Setting Lock

Once you've adjusted all of these settings the way you like them, you may want to disable the Multi-Function knob so none of your settings can be changed. This is especially handy if you operate multiple vehicles with a single transmitter via Traxxas Link™ Model Memory.

Multiple Settings and the Multi-Function Knob

It is important to note that settings made with the Multi-Function knob are "overlaid" on top of each other. For example, if you assign the Multi-Function to adjust Steering Percentage and set it for 50%, then reassign the knob to control Steering Sensitivity, the transmitter will "remember" the Steering Percentage setting. Adjustments you make to Steering Sensitivity will be applied to the 50% steering throw setting you selected previously. Likewise, setting the Multi-Function knob to "disabled" will prevent the knob from making further adjustments, but the last setting of the Multi-Function knob will still apply.



Failsafe

Your Traxxas radio system is equipped with a built-in failsafe function that returns the throttle to its last saved neutral position in the event of a signal loss. The LED on the transmitter and the receiver will rapidly flash red.

TRANSMITTER LED CODES

LED Color / Pattern	Name	Notes	
	Solid green	Normal Driving Mode	See page 13 for information on how to use your transmitter controls.
	Slow red (0.5 sec on / 0.5 sec off)	Binding	See page 15 for more information on binding.
	Flashing fast green (0.1 sec on / 0.15 sec off)	Throttle Trim Seek Mode	Turn the Multi-Function knob right or left until the LED stops flashing. See page 28 for more information.
	Flashing medium red (0.25 sec on / 0.25 sec off)	Low Battery Alarm	Put new batteries in the transmitter. See page 12 for more information.
	Flashing fast red (0.125 sec on / 0.125 sec off)	Link Failure / Error	Transmitter and receiver are no longer bound. Turn the system off and then back on to resume normal operation. Find source of the link failure (i.e., out of range, low batteries, damaged antenna).
Programming Patterns			
	Counts out number (green or red), then pauses	Current menu position	See Menu Tree for more information.
	Fast green 8 times	Menu setting accepted (on SET)	
	Fast red 8 times	Menu SET invalid	User error, such as trying to delete a locked model.

RECEIVER LED CODES

LED Color / Pattern	Name	Notes	
	Solid green	Normal Driving Mode	See page 13 for information on how to use your transmitter controls.
	Slow red (0.5 sec on / 0.5 sec off)	Binding	See page 15 for more information on binding.
	Flashing fast red (0.125 sec on / 0.125 sec off)	Fail-Safe / Low Voltage Detect	Consistent low voltage in the receiver triggers Fail-Safe so there is enough power to center the throttle servo before it completely loses power.

TRAXXAS LINK MODEL MEMORY

Traxxas Link Model Memory is an exclusive, patented feature of the TQi transmitter. Each time the transmitter is bound to a new receiver, it saves that receiver in its memory, along with all the settings assigned to that receiver. When the transmitter and any bound receiver are switched on, the transmitter automatically recalls the settings for that receiver. There is no need to manually select your vehicle from a list of model memory entries.

Model Lock

The Traxxas Link Model Memory feature can store up to thirty models (receivers) in its memory. If you bind a thirty-first receiver, Traxxas Link Model Memory will delete the “oldest” receiver from its memory (in other words, the model you used the longest time ago will be deleted). Activating Model Lock will lock the receiver in memory so it cannot be deleted.

You may also bind multiple TQi transmitters to the same model, making it possible to pick up any transmitter and any previously bound model in your collection and simply turn them on and drive. With Traxxas Link Model Memory, there is no need to remember which transmitter goes with which model, and there is never a need to have to select any model from a list of model memory entries. The transmitter and receiver do it all for you automatically.

To activate Model Lock:

1. Switch on the transmitter and receiver you wish to lock.
2. Press and hold MENU. Release when the status LED blinks green.
3. Press MENU three times. The status LED will blink green four times repeatedly.
4. Press SET. The status LED will blink green in single-flash intervals.
5. Press SET once. The status LED will blink red once repeatedly.
6. Press MENU once. The status LED will blink red twice repeatedly.
7. Press SET. The LED will blink rapidly green. The memory is now locked. Press and hold MENU to return to driving mode.

Note: To unlock a memory, press SET twice at step 5. The LED will blink rapidly green to indicate the model is unlocked. To unlock all models, press MENU twice at step 6 and then press SET.

To delete a model:

At some point, you may wish to delete a model you no-longer drive from the memory.

1. Switch on the transmitter and receiver you wish to delete.
2. Press and hold MENU. Release when the status LED blinks green.
3. Press MENU three times. The status LED will blink green four times repeatedly.
4. Press SET once. The status LED will blink green once repeatedly.
5. Press MENU once. The status LED will blink green twice repeatedly.
6. Press SET. The memory is now selected to be deleted. Press SET to delete the model. Press and hold MENU to return to driving mode.

MENU TREE

The Menu Tree below shows how to navigate through the TQi transmitter's various settings and functions. Press and hold MENU to enter the Menu Tree, and use the following commands to navigate through the menu and select options.

MENU: When you enter a menu, you always start at the top. Press MENU to move down the Menu Tree. When you reach the bottom of the tree, pressing MENU again will return you to the top.

SET: Press SET to move across the Menu Tree and select options. When an option is committed to the transmitter's memory, the status LED will rapidly blink green.

BACK: Press both MENU and SET to go back one level in the Menu Tree.

EXIT: Press and hold MENU to exit programming. Your selected options will be saved.

ECHO: Press and hold SET to activate the "echo" function. Echo will "play back" your current position on the Menu Tree should you lose your place. For example: If your current position is Steering Channel End Points, holding SET will cause the LED to blink green twice, green once, and then red three times. Echo will not alter your adjustments or change your position in the programming sequence.

Below is an example of how to access a function in the Menu Tree. In the example, the user is setting the Multi-Function knob to be a Steering % (Dual-Rate) control.

- To set the Multi-Function knob to control STEERING % (DUAL-RATE):
- 1. Switch the transmitter on.
- 2. Press and hold MENU until the green LED lights. It will blink in single intervals.
- 3. Press SET. The red LED will blink in single intervals to indicate Steering Sensitivity (Expo) has been selected.
- 4. Press MENU twice. The red LED will blink three times repeatedly to indicate Steering % (Dual-Rate) has been selected.
- 5. Press SET to select. The green LED will blink 8 times fast to indicate successful selection.
- 6. Press and hold MENU to return to driving mode.

Restoring Factory Defaults:

Transmitter OFF	Hold both MENU and SET	Transmitter ON	Release MENU and SET red LED blinks	Press SET to clear settings. LED will turn solid green. Transmitter is restored to default
-----------------	------------------------	----------------	--	--

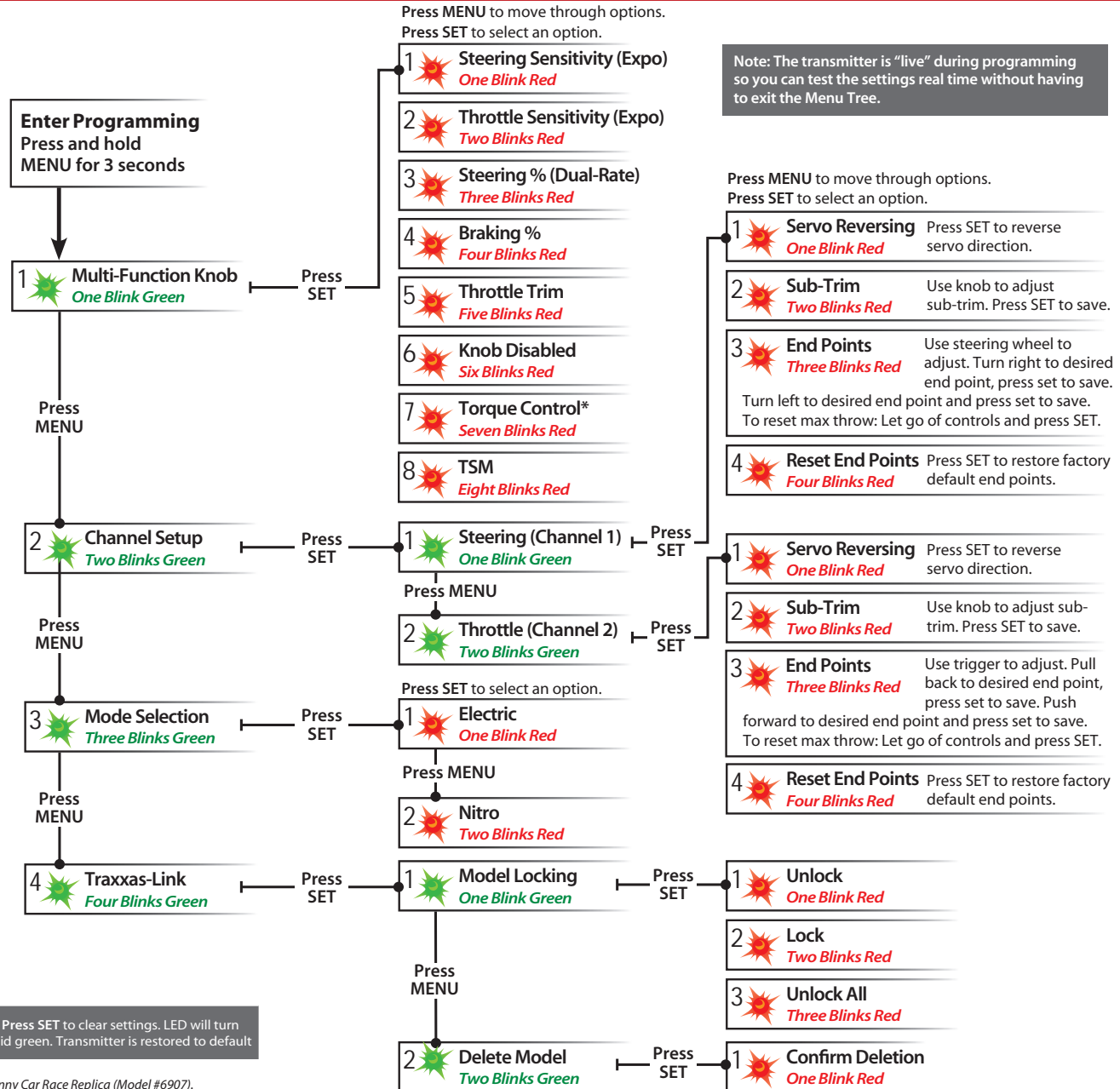

Note: The transmitter is "live" during programming so you can test the settings real time without having to exit the Menu Tree.

*Torque Control is a feature designed only for use with the power system in the Traxxas Funny Car Race Replica (Model #6907).

Set Multi-Function knob for STEERING SENSITIVITY (Expo)	Press/hold MENU green LED blinks	Press SET red LED blinks	Press SET to confirm green LED blinks (x8)	Press/hold MENU returns to driving mode						
Set Multi-Function knob for THROTTLE SENSITIVITY (Expo)	Press/hold MENU green LED blinks	Press SET red LED blinks	Press MENU to confirm red LED blinks (x2)	Press SET to select green LED blinks (x8)	Press/hold MENU returns to driving mode					
Set Multi-Function knob for STEERING DUAL RATE (%)	Press/hold MENU green LED blinks	Press SET red LED blinks	Press MENU twice red LED blinks (x3)	Press SET to select green LED blinks (x8)	Press/hold MENU returns to driving mode					
Set Multi-Function knob for BRAKING PERCENTAGE (%)	Press/hold MENU green LED blinks	Press SET red LED blinks	Press MENU 3 times red LED blinks (x4)	Press SET to select green LED blinks (x8)	Press/hold MENU returns to driving mode					
Set Multi-Function knob for THROTTLE TRIM	Press/hold MENU green LED blinks	Press SET red LED blinks	Press MENU 4 times red LED blinks (x5)	Press SET to select green LED blinks (x8)	Press/hold MENU returns to driving mode	Adjust the Multi-Function knob until the LED turns solid green.				
To LOCK the Multi-Function knob	Press/hold MENU green LED blinks	Press SET red LED blinks	Press MENU 5 times red LED blinks (x6)	Press SET to lock green LED blinks (x8)	Press/hold MENU returns to driving mode					
To REVERSE the direction of STEERING servo	Press/hold MENU green LED blinks	Press MENU green LED blinks (x2)	Press SET green LED blinks	Press SET red LED blinks	Press SET to reverse servo direction	Press/hold MENU returns to driving mode				
To set the SUB TRIM of the STEERING servo	Press/hold MENU green LED blinks	Press MENU green LED blinks (x2)	Press SET green LED blinks	Press SET red LED blinks	Press MENU red LED blinks (x2)	Use Multi-Function knob to set neutral	Press SET to save position	Press/hold MENU returns to driving mode		
To set the END POINTS of the STEERING servo	Press/hold MENU green LED blinks	Press MENU green LED blinks (x2)	Press SET green LED blinks	Press SET red LED blinks	Press MENU twice red LED blinks (x3)	Turn steering wheel to desired max left and right travel	Press SET to save each position	Turn steering wheel to test settings	IF END POINTS ARE OK: Press/hold MENU returns to driving mode	IF END POINTS NEED TO BE CHANGED: Press SET and repeat steps 6-8
To reset the END POINTS of STEERING servo to defaults	Press/hold MENU green LED blinks	Press MENU green LED blinks (x2)	Press SET green LED blinks	Press SET red LED blinks	Press MENU 3 times red LED blinks (x4)	Press SET to reset end points	Press/hold MENU returns to driving mode			
To REVERSE the direction of THROTTLE servo	Press/hold MENU green LED blinks	Press MENU green LED blinks (x2)	Press SET green LED blinks	Press MENU green LED blinks (x2)	Press SET red LED blinks	Press SET to reverse servo direction	Press/hold MENU returns to driving mode			
To set the SUB TRIM of the THROTTLE servo	Press/hold MENU green LED blinks	Press MENU green LED blinks (x2)	Press SET green LED blinks	Press MENU green LED blinks (x2)	Press SET red LED blinks	Press MENU red LED blinks (x2)	Use Multi-Function knob to set neutral	Press SET to save position	Press/hold MENU returns to driving mode	
To set the END POINTS of the THROTTLE servo	Press/hold MENU green LED blinks	Press MENU green LED blinks (x2)	Press SET green LED blinks	Press MENU green LED blinks (x2)	Press SET red LED blinks	Press MENU twice red LED blinks (x3)	Use throttle trigger to set desired max throttle or brake	Press SET to save Use trigger to test	IF END POINTS ARE OK: Press/hold MENU returns to driving mode	IF END POINTS NEED TO BE CHANGED: Press SET and repeat steps 7-9
To reset the END POINTS of THROTTLE servo to defaults	Press/hold MENU green LED blinks	Press MENU green LED blinks (x2)	Press SET green LED blinks	Press MENU green LED blinks (x2)	Press SET red LED blinks	Press MENU 3 times red LED blinks (x4)	Press SET green LED blinks (x8)	Press/hold MENU returns to driving mode		

MENU TREE FORMULAS

To select functions and make adjustments to the TQi transmitter without referencing the menu tree, turn your transmitter on, find the function in the left column you wish to adjust, and simply follow the corresponding steps.



Always turn your transmitter on first.

PROGRAMMING YOUR TQi TRANSMITTER WITH YOUR APPLE IPHONE, IPAD, IPOD TOUCH, OR ANDROID MOBILE DEVICE

The Traxxas Link™ Wireless Module (part #6511, sold separately) for the TQi transmitter installs in minutes to transform your Apple® iPhone®, iPad®, iPod touch®, or Android™ device into a powerful tuning tool that allows you to replace the transmitter's button/LED programming system with an intuitive, high-definition, full-color graphical user interface.



Traxxas Link

The powerful Traxxas Link app (available in the Apple App Store™ or on Google Play™) gives you complete control over the operation and tuning of your Traxxas model with stunning visuals and absolute precision. Install Traxxas Link telemetry sensors on the model, and Traxxas Link displays real-time data such as speed, RPM, temperature, and battery voltage.



Compatible with:
iPod touch (5th generation and later)
iPad mini
iPad Pro

iPad 2
iPad Air
iPhone 4s (and later)
Android 4.4 (and later)

Intuitive iPhone, iPad, iPod touch, and Android interface
Traxxas Link makes it easy to learn, understand, and access powerful tuning options. Control Drive Effects settings such as TSM assistance percentage; steering and throttle sensitivity; steering percentage; braking strength; and throttle trim by simply touching and dragging the sliders on the screen.

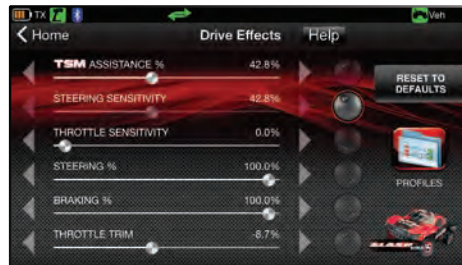

Tap and slide to adjust TSM, Steering Sensitivity, Throttle Trim, Braking Percent, and more!

Real-Time Telemetry

When you equip your model with sensors, the Traxxas Link dashboard comes to life showing you speed, battery voltage, RPM, and temperature. Set threshold warnings and log maximums, minimums, or averages. Use the recording function to document your dashboard view, with sound, so that you can keep your eyes on your driving and not miss a single apex.

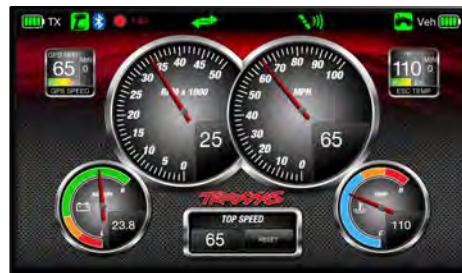

The customizable Traxxas Link dashboard delivers real-time rpm, speed, temperature, and voltage data.

Manage up to 30 Models with Traxxas Link

The TQi radio system automatically keeps track of what vehicles it has bound to and what settings were used for each--up to 30 models total! Traxxas Link provides a visual interface to name the models, customize their settings, attach profiles, and lock them into memory. Simply choose a model and any previously bound transmitter, power them up, and start having fun.



Traxxas Link Model Memory simplifies organizing your collection of vehicles.

i The Traxxas Link Wireless Module is sold separately (part #6511). The Traxxas Link application is available from the Apple App store for iPhone, iPad, or iPod touch and on Google Play for Android devices. iPhone, iPad, iPod touch, or the Android device are not included with the Traxxas Link Wireless Module.

For more information about the Traxxas Link Wireless Module and the Traxxas Link application, visit Traxxas.com.



MAVOK®

OWNER'S MANUAL

MODEL 89086-4

TRAXXAS®

6250 TRAXXAS WAY, MCKINNEY, TX 75070
1-888-TRAXXAS