

Minimoa #15135

Bauanleitung

PICHLER



<i>Spezifikationen</i>	
Spannweite	1.422mm
Flügelfläche	13,7 ² dm
Abfluggewicht	ca. 310g
Rumpflänge	623mm
Maßstab	1 / 12

Bauhinweise:

1. Lesen Sie die Anleitung vor dem Bau einmal durch um eine Übersicht zu erhalten.
2. Prüfen Sie den Bausatz auf Vollständigkeit.
3. Halten Sie sich beim Bau des Modells genau an die Anleitung.
4. Mit einem 250-400er Sandpapier lassen sich die Lasercut Teile ideal vorschleifen.



Lieferumfang

Hardware	
PVC Haube (vorne)	1
PVC Haube (hinten)	1
6mm PVC Rohr	1
4mm PVC Rohr	1
Kunststoff-Scharnier	5
Mini-Papier-Scharnier	8
Schrauben M2x20	3
Schrauben M1.6x5	8
Schrauben M1.78x8	2
M2 Muttern	1
M2 Zahnmuttern	2
0.8mm Stahl-Schubstange	4
1.0mm Stahl-Schubstange	1
Stahldraht-Adapter	4
1.0mm Carbon-Stange	2
Schrumpfschlauch	2

Holzplatten	
1.5mm Balsa	1
1mm Balsa	11
2.5mm Balsa	1
1mm Sperrholz	2
1.5mm Sperrholz	1
1mm Paulownia	2

Diverses	
1:1 Bauplan	1

Empfohlenes Sonderzubehör:

- GigaProp 6 #C8802/C8830
- DS706MG #C6702
- MASTER i4 Empfänger #C2306

1. Leitwerk

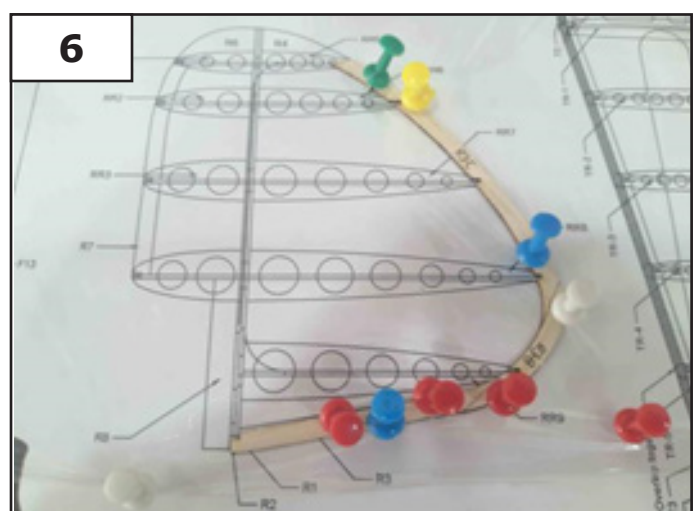
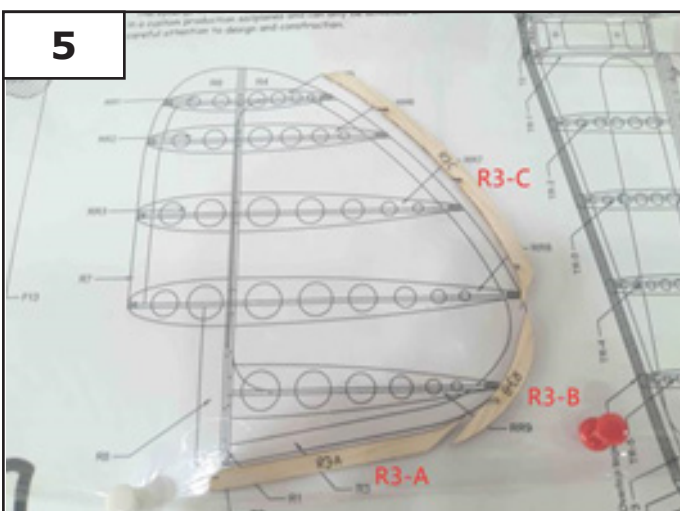
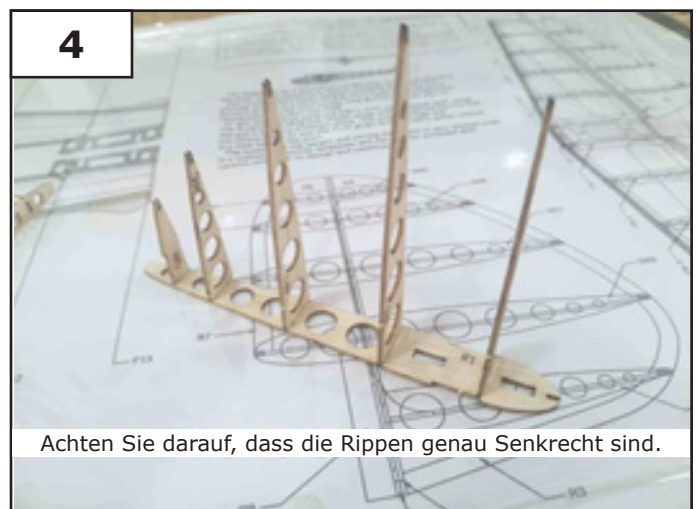
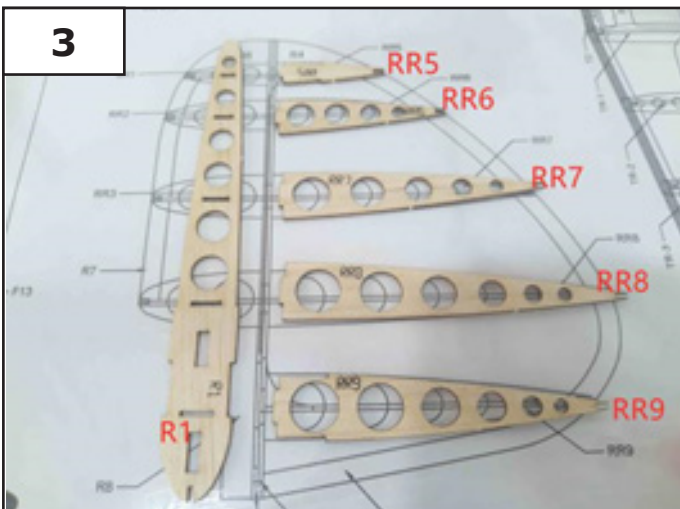
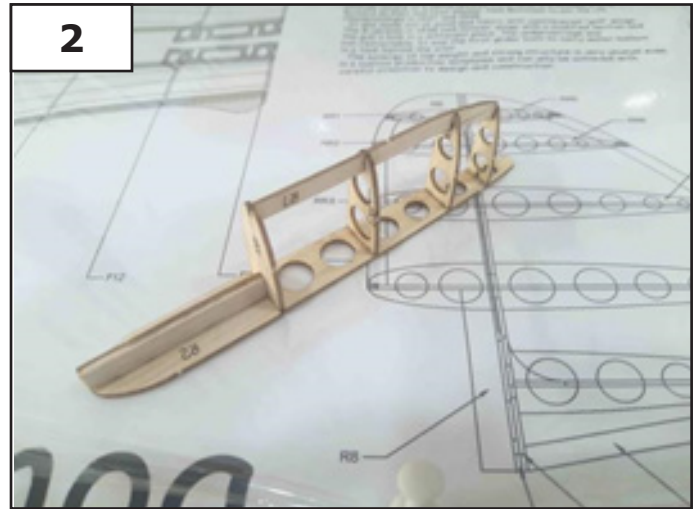
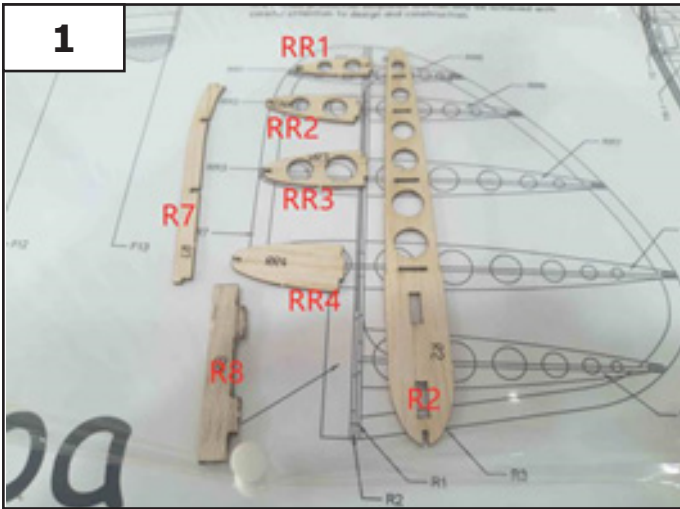

1. Leitwerk

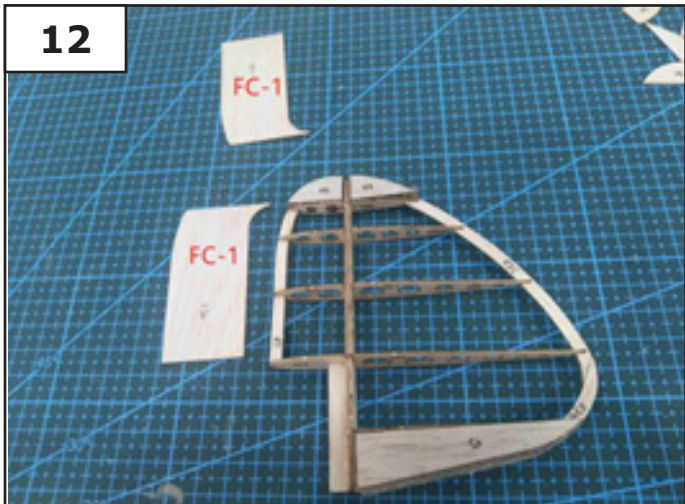
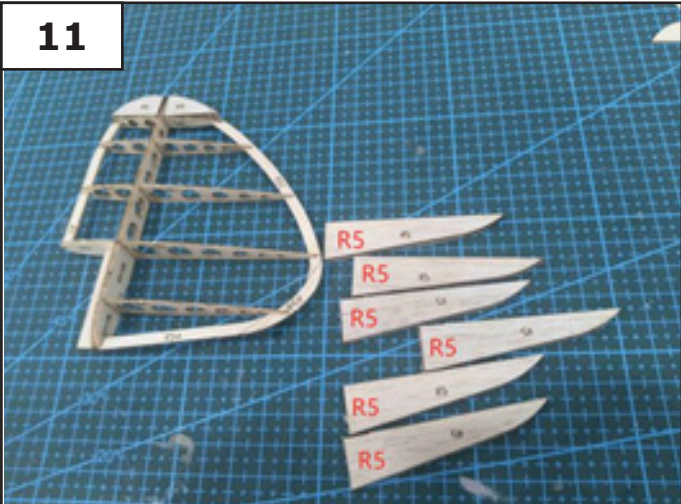
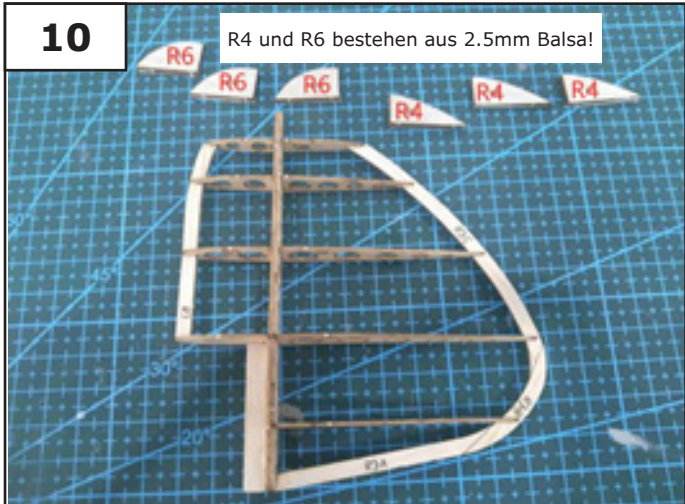
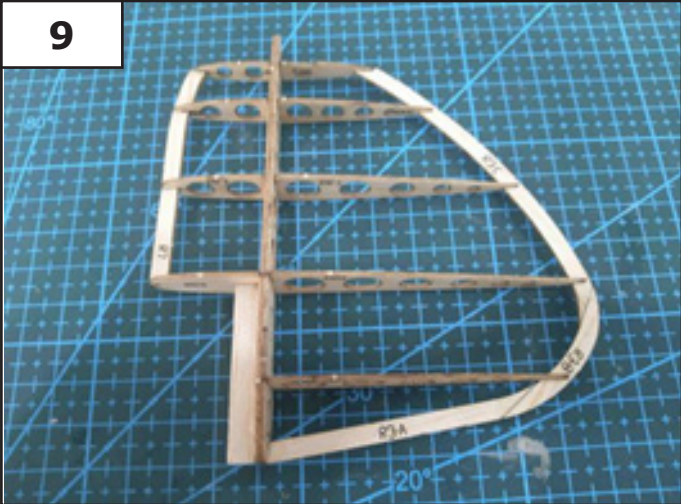
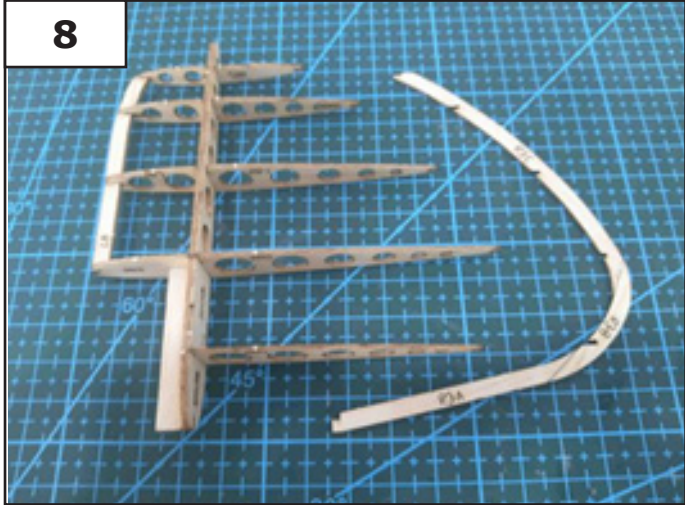
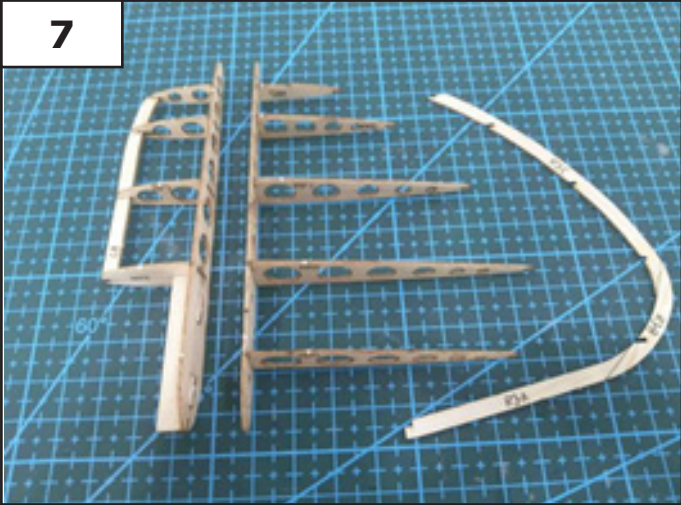

1. Leitwerk

13



Außenseite mit Wasser anfeuchten.

14

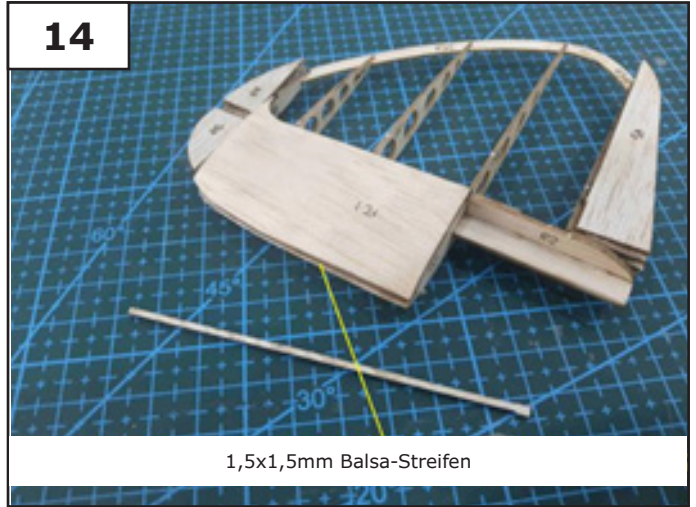

1,5x1,5mm Balsa-Streifen

15

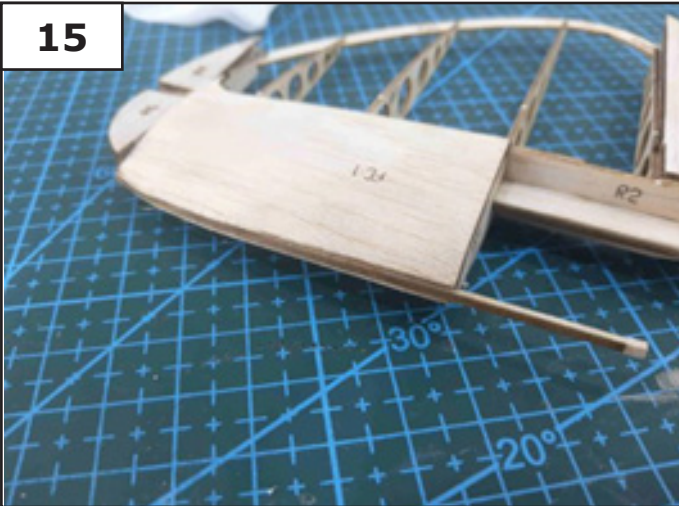

16

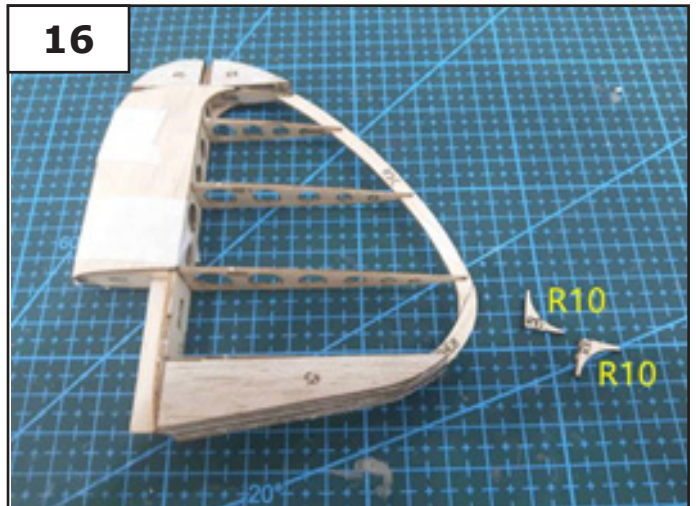

17

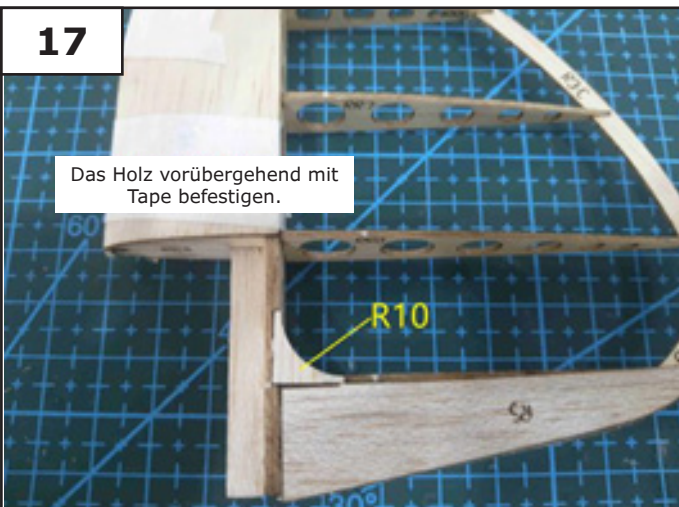

Das Holz vorübergehend mit Tape befestigen.

18

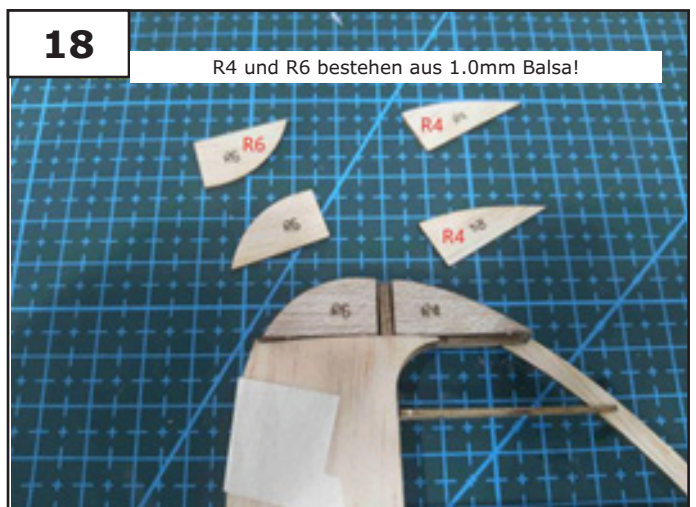

R4 und R6 bestehen aus 1.0mm Balsa!

1. Leitwerk

19

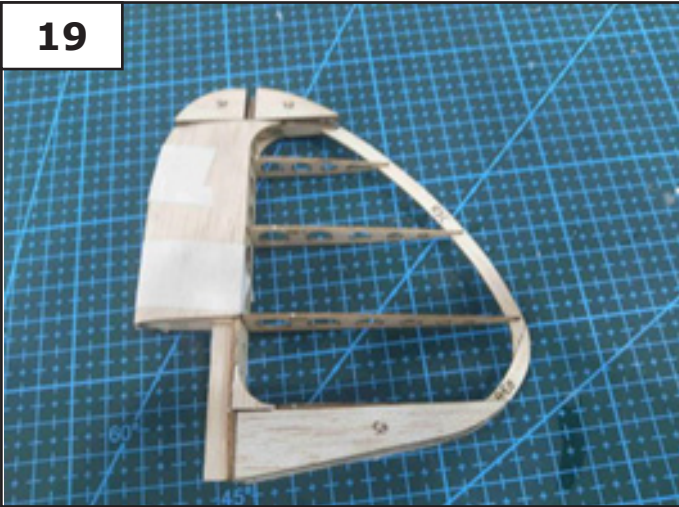

20

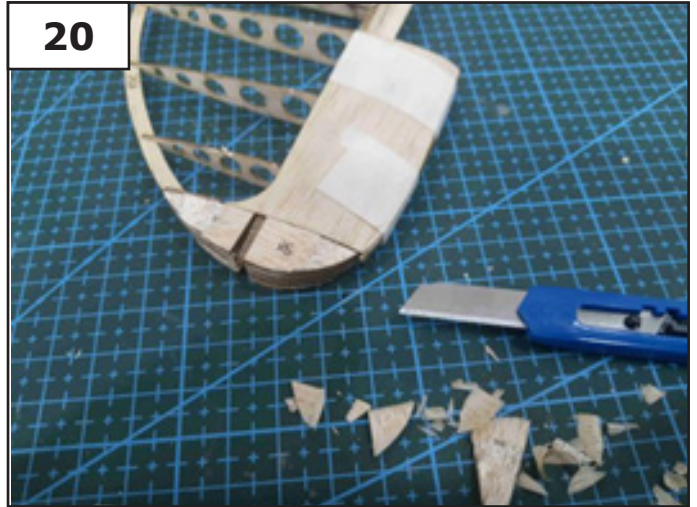

21

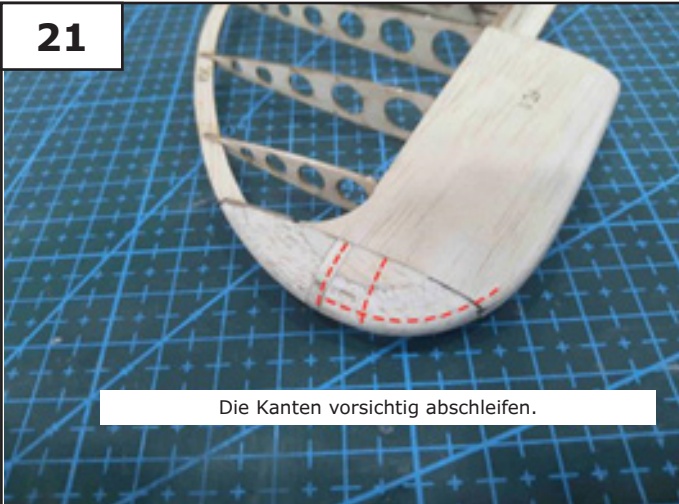

Die Kanten vorsichtig abschleifen.

22



23



Die Kanten vorsichtig abschleifen.

24



Die Lücken mit etwas übrigem Holz füllen.

2. Höhenruder

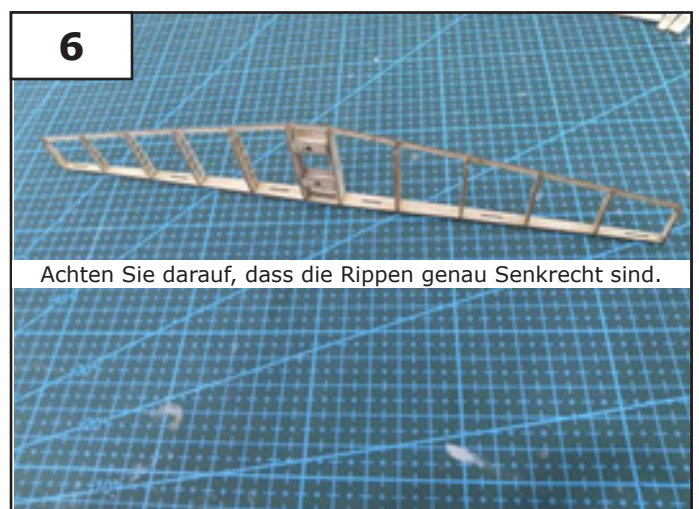
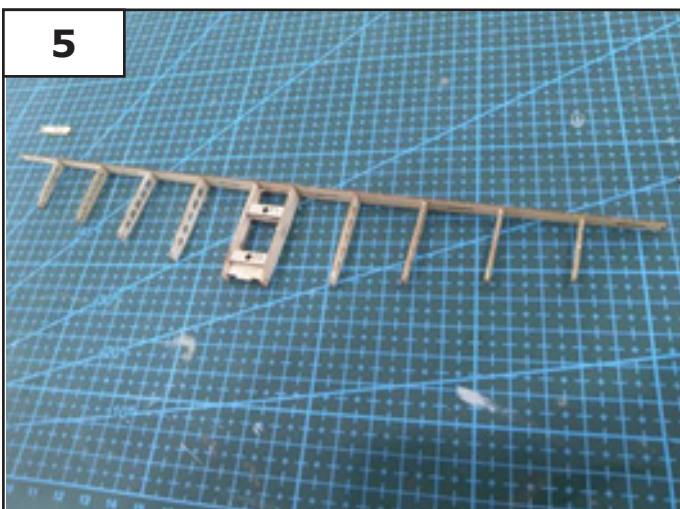
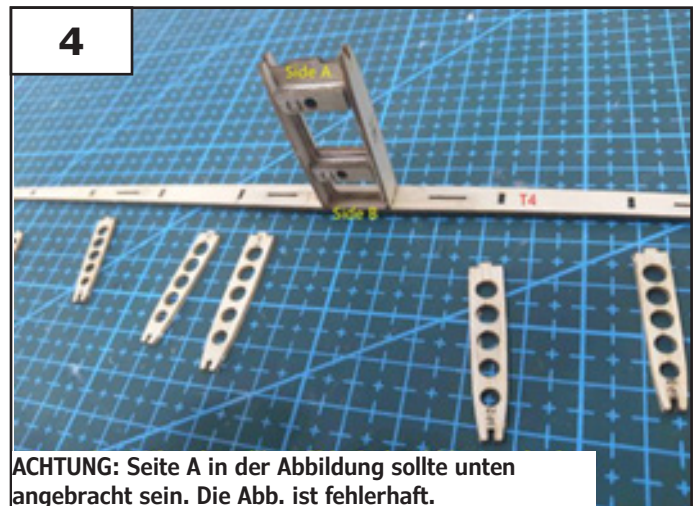
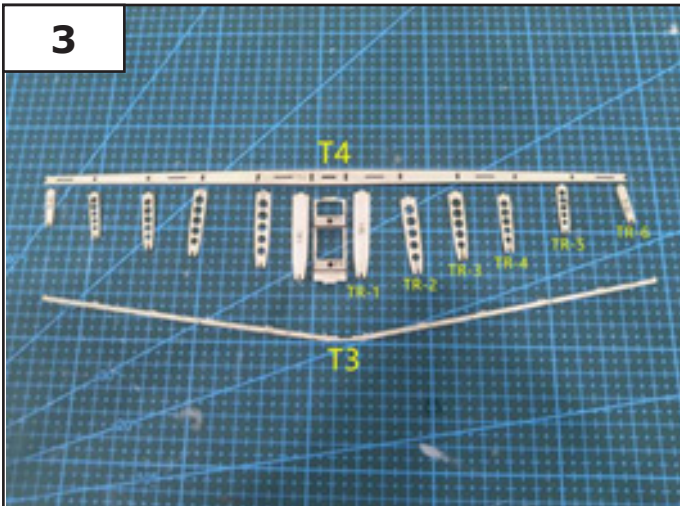
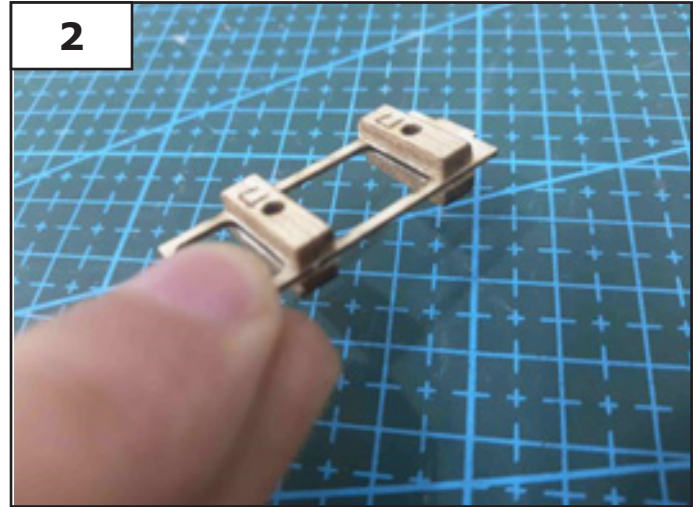
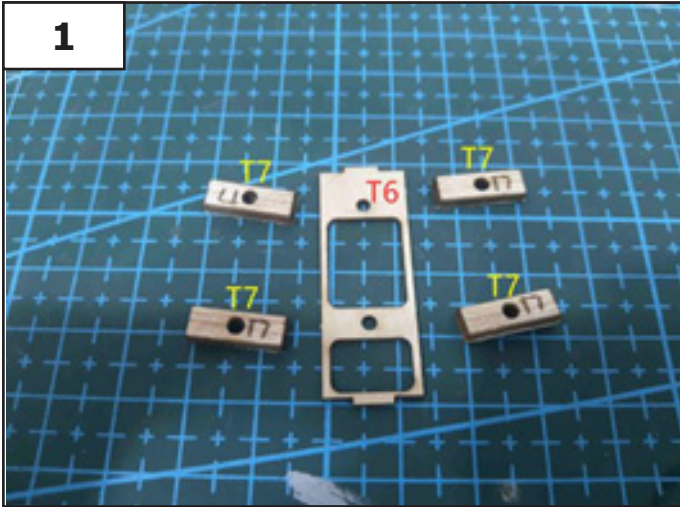

2. Höhenruder

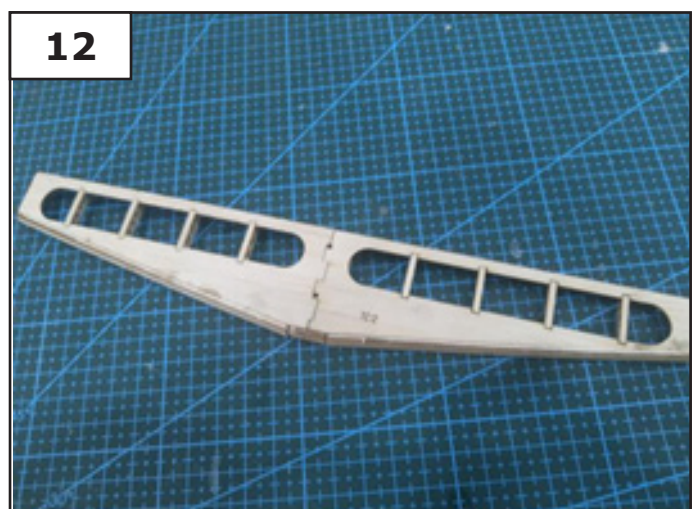
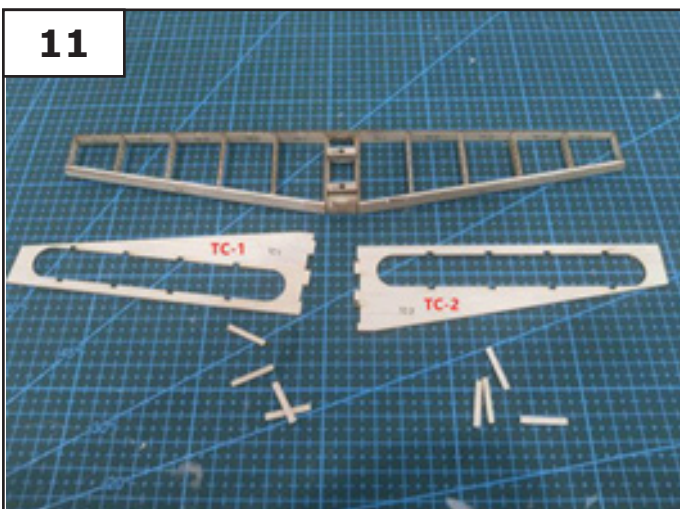
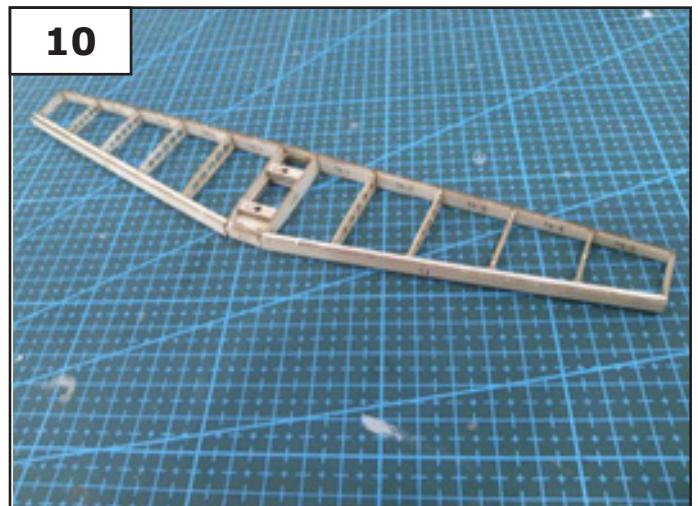
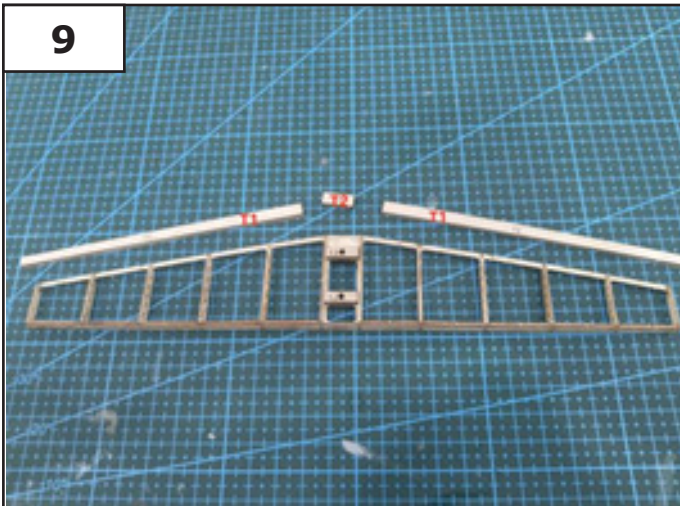
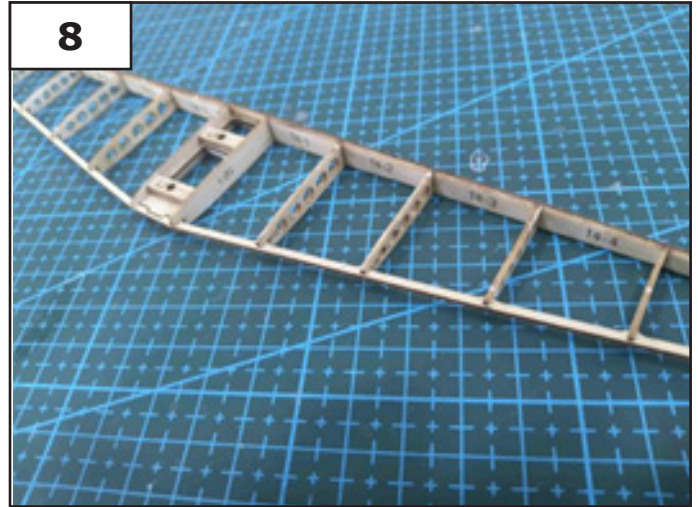
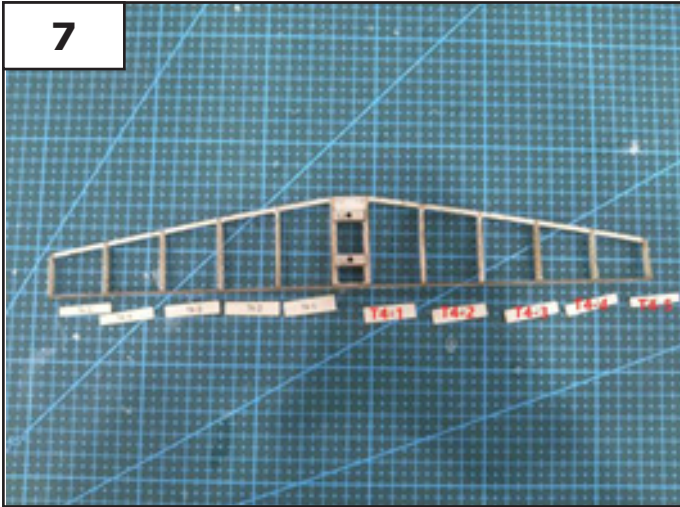

2. Höhenruder

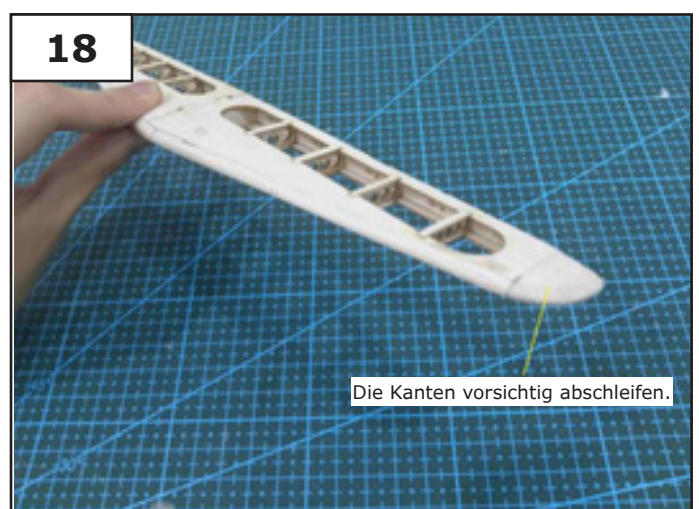
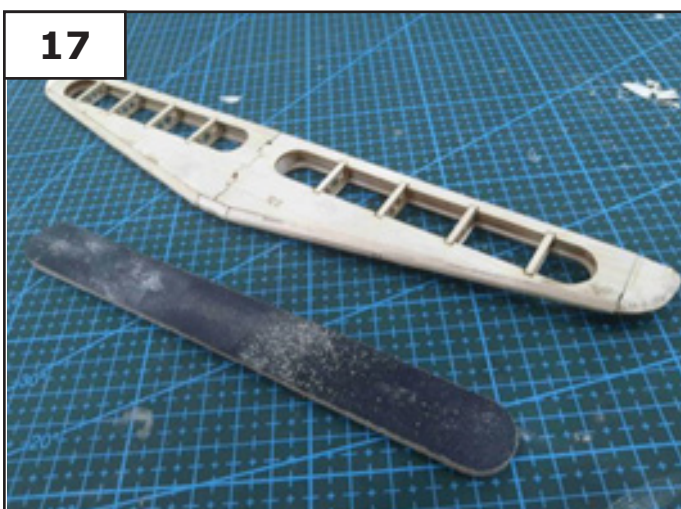
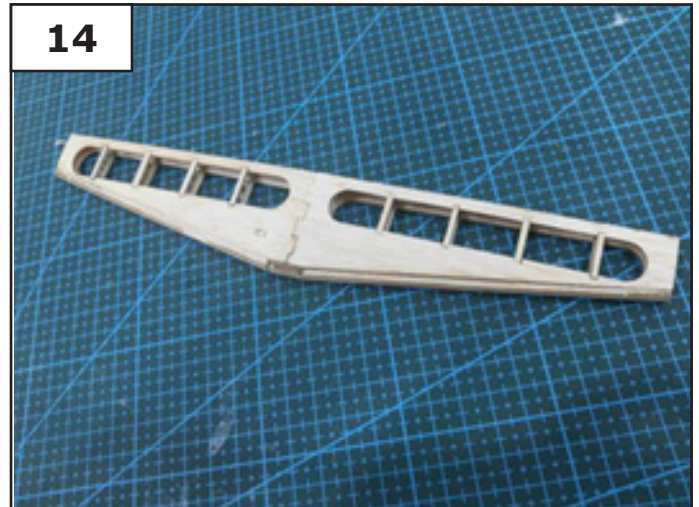
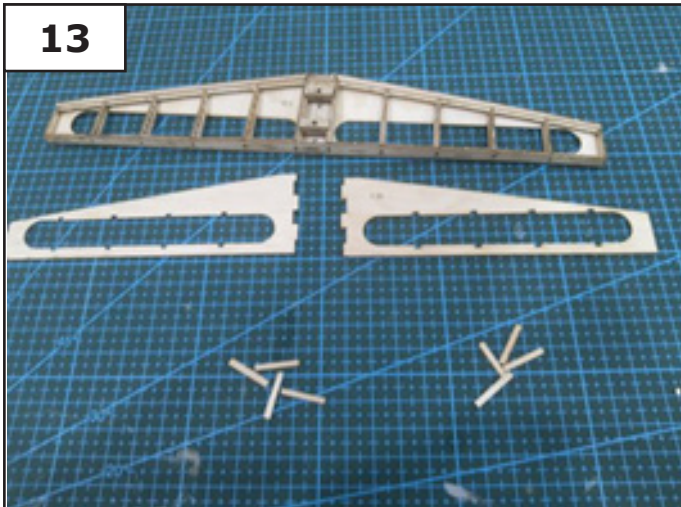

2. Höhenruder

19

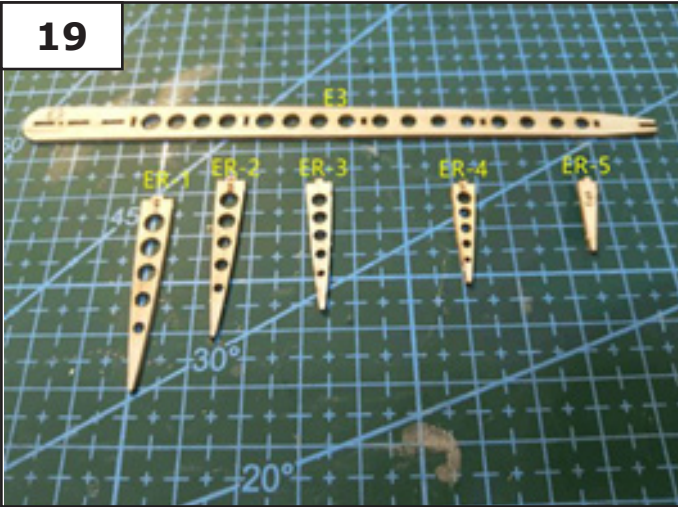

20

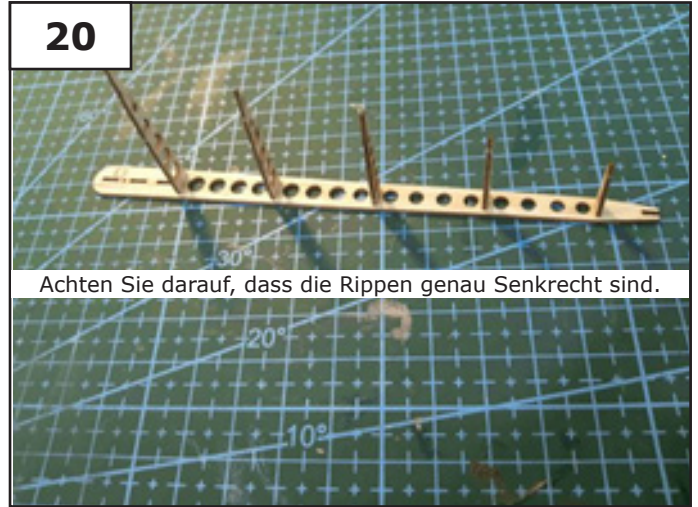

21

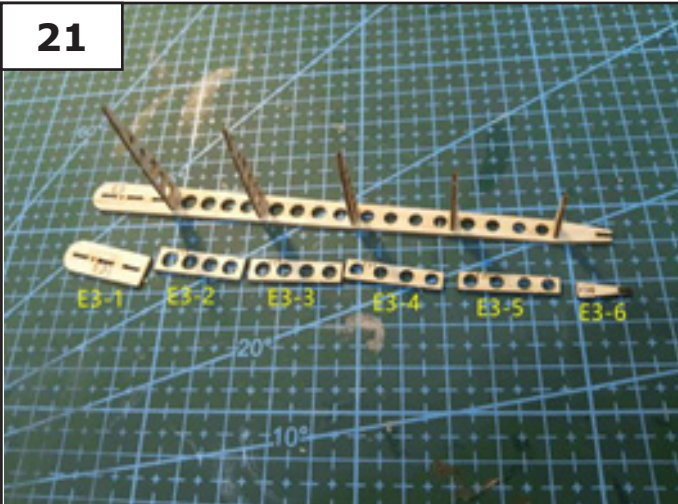

22

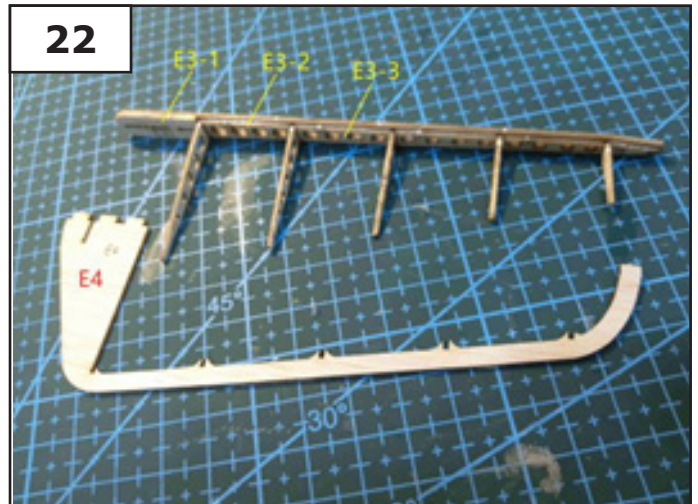

23

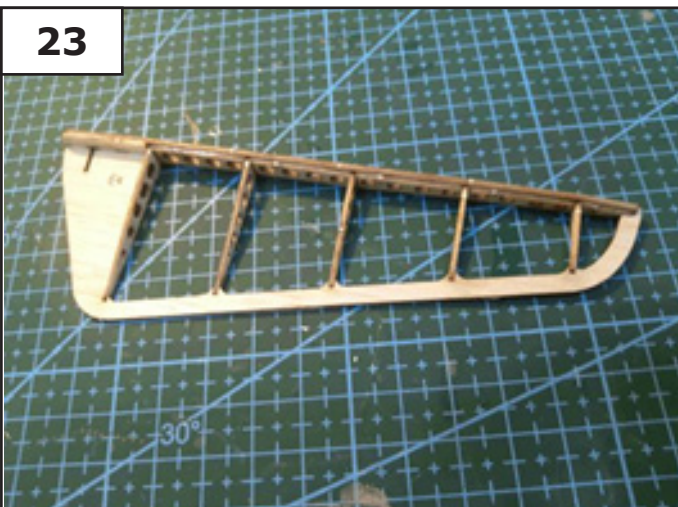

24

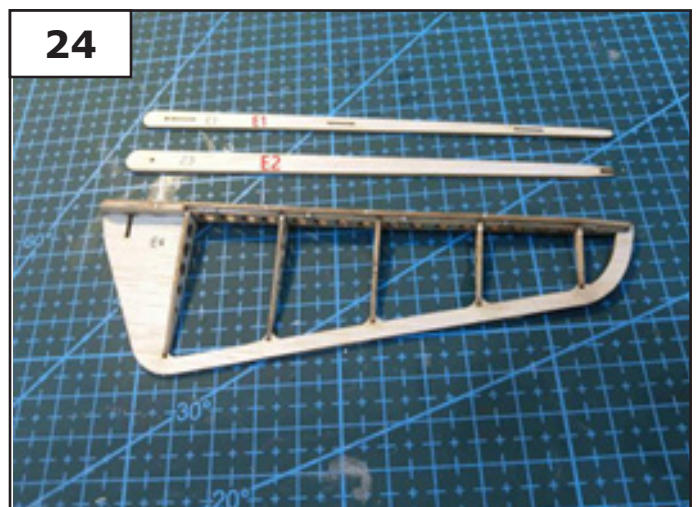

2. Höhenruder

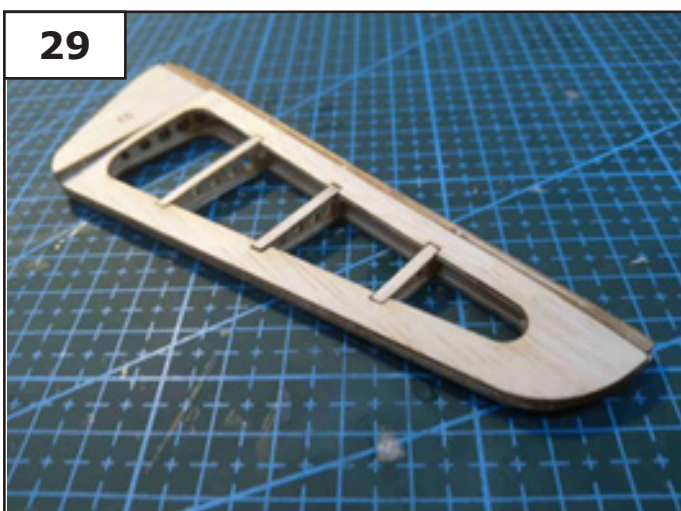
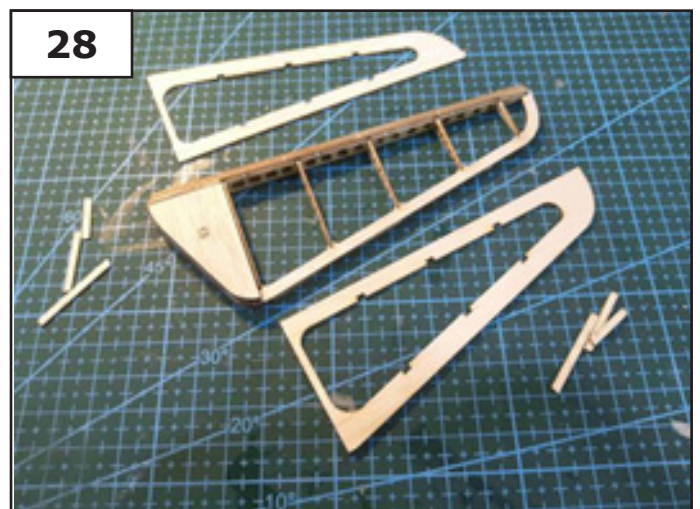
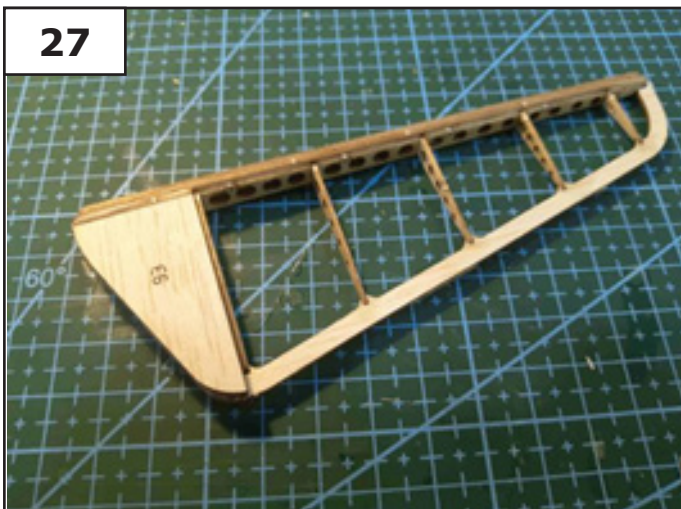
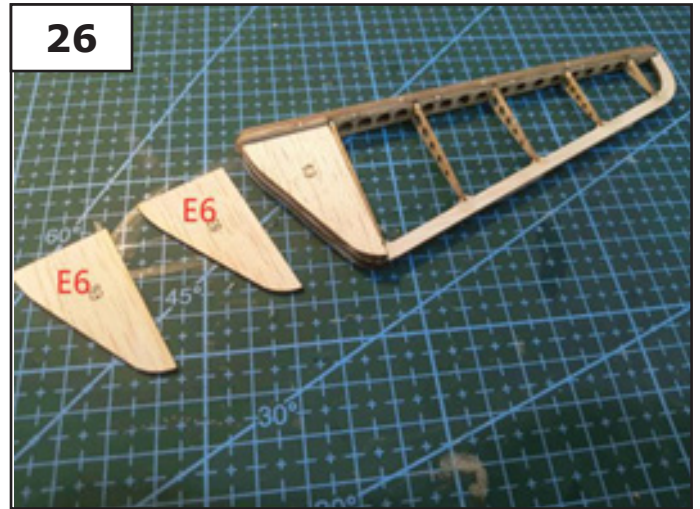
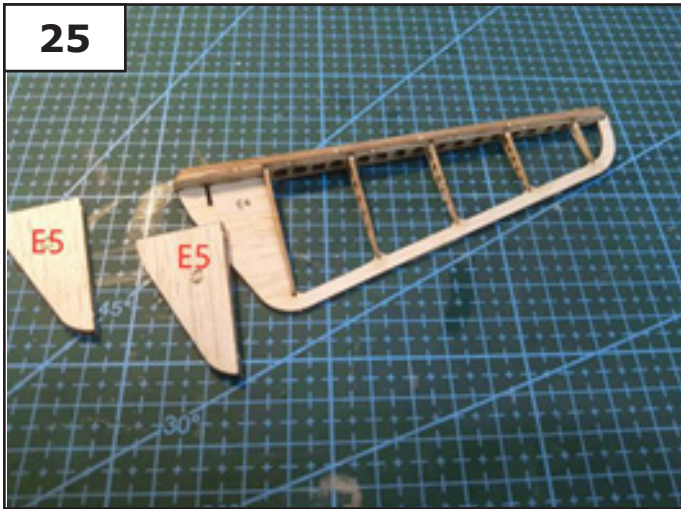

2. Höhenruder

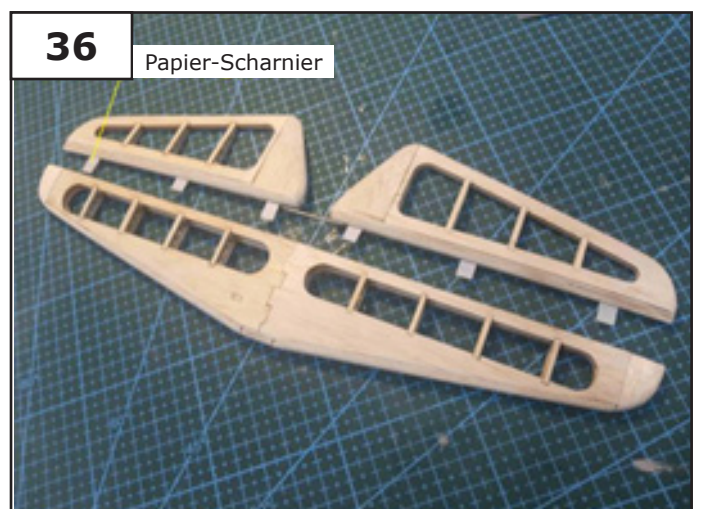
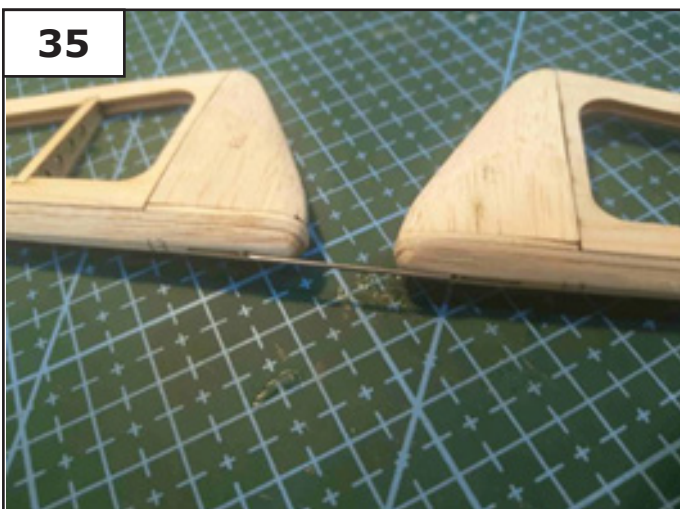
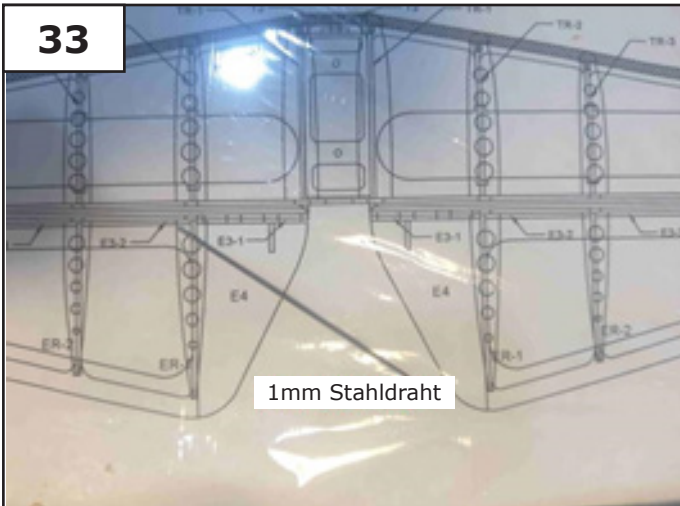
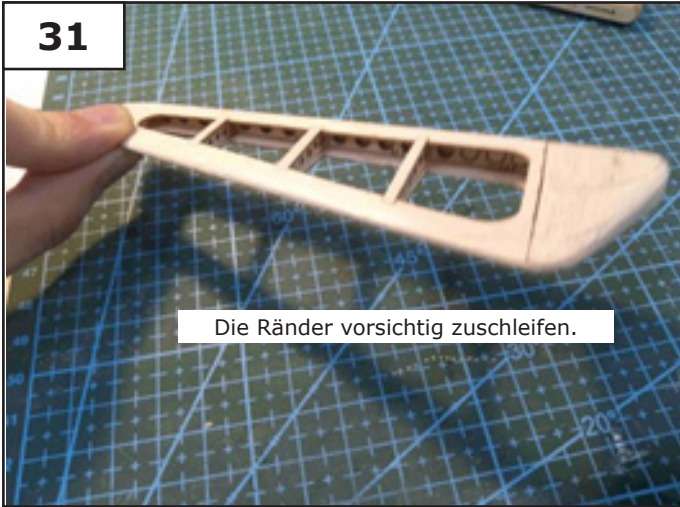

3. Rumpf

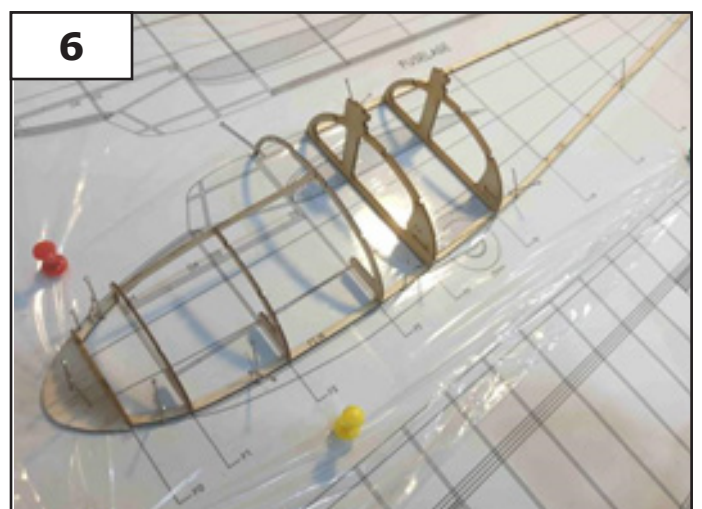
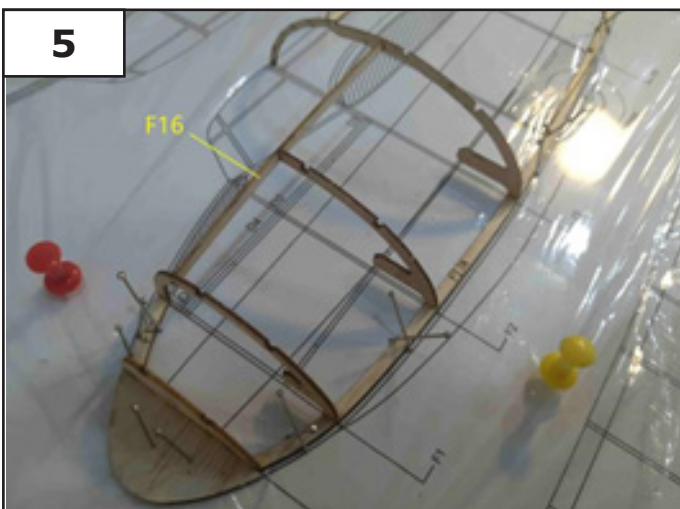
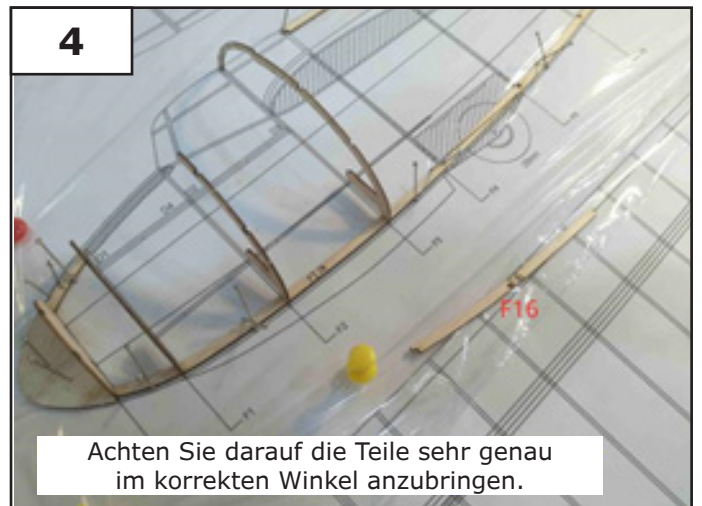
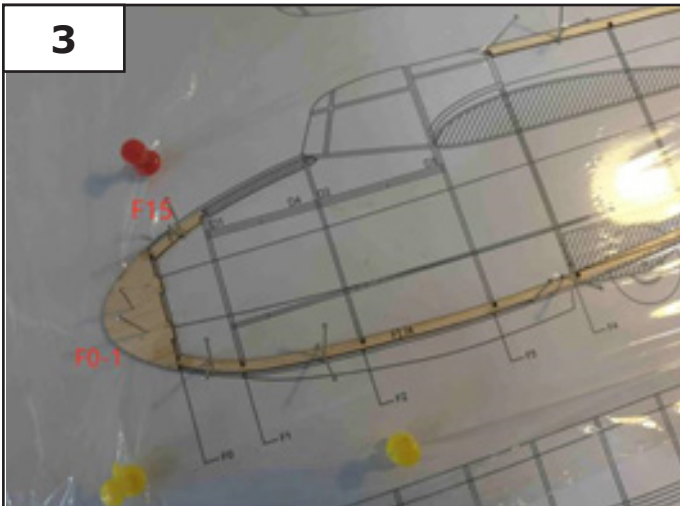
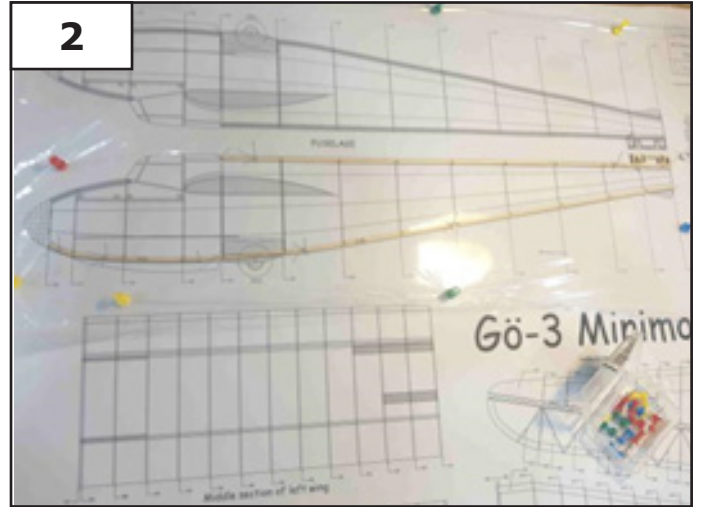
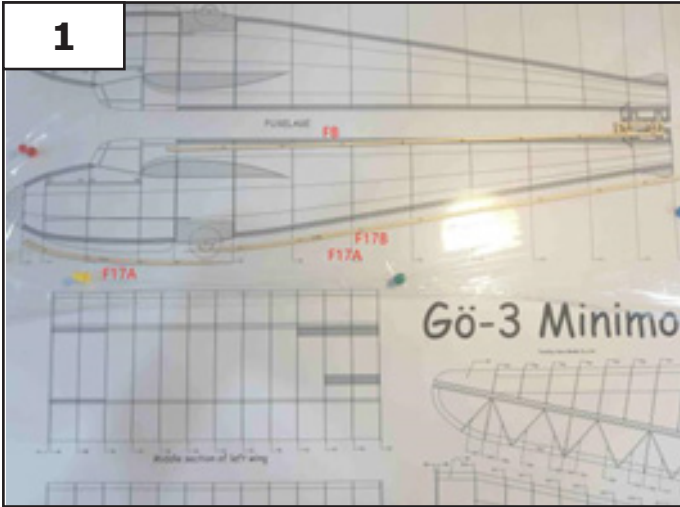

3. Rumpf

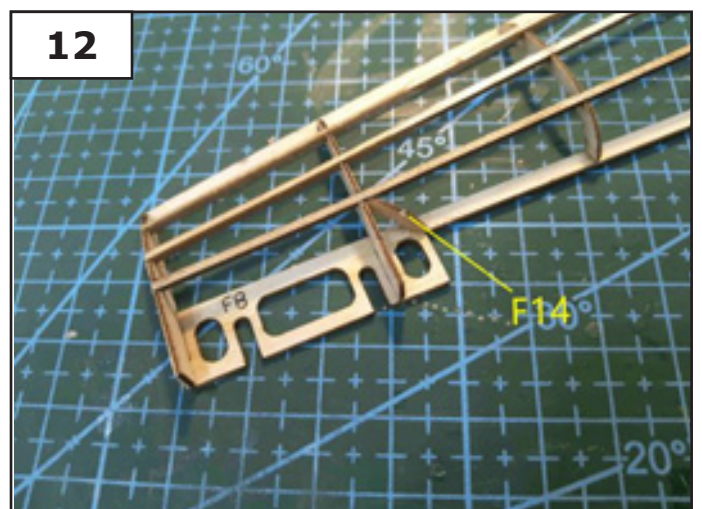
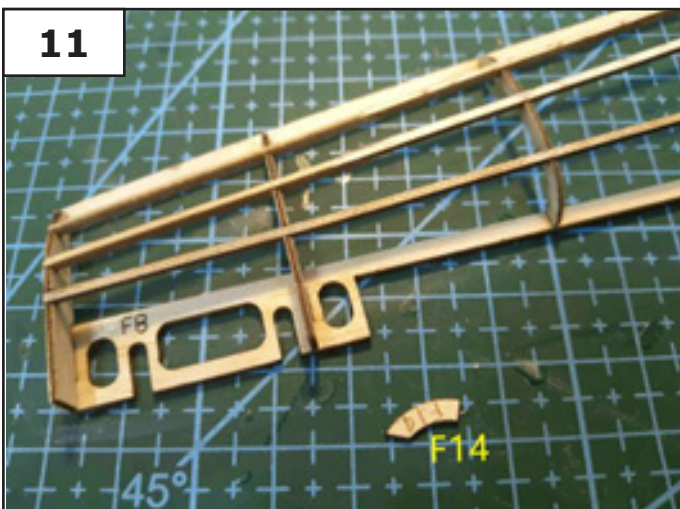
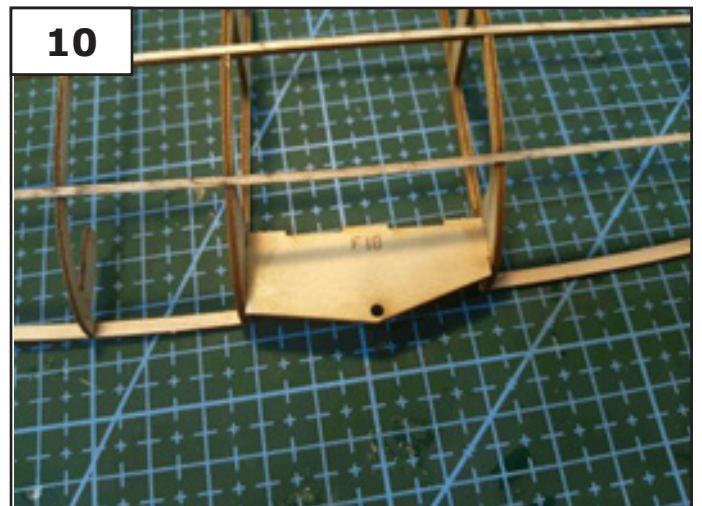
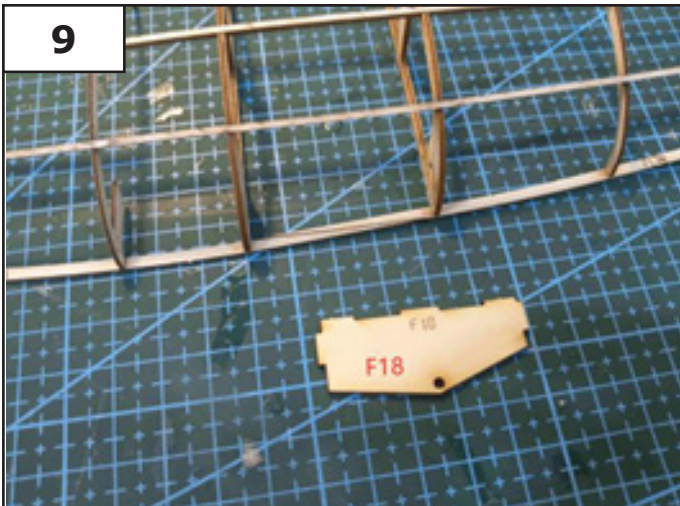
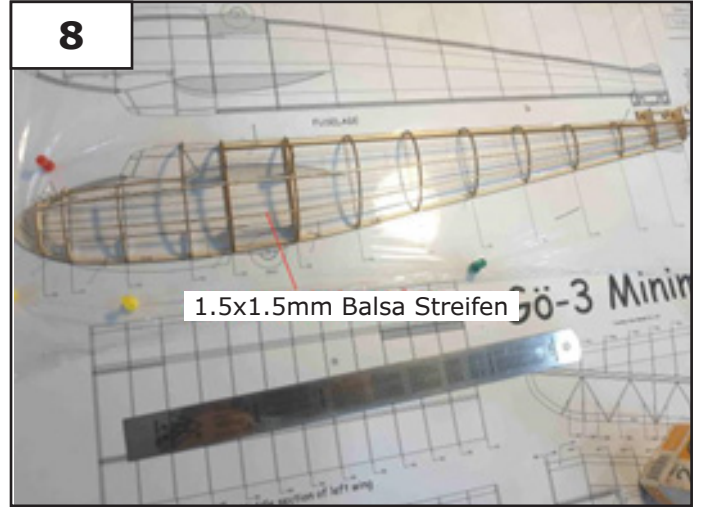
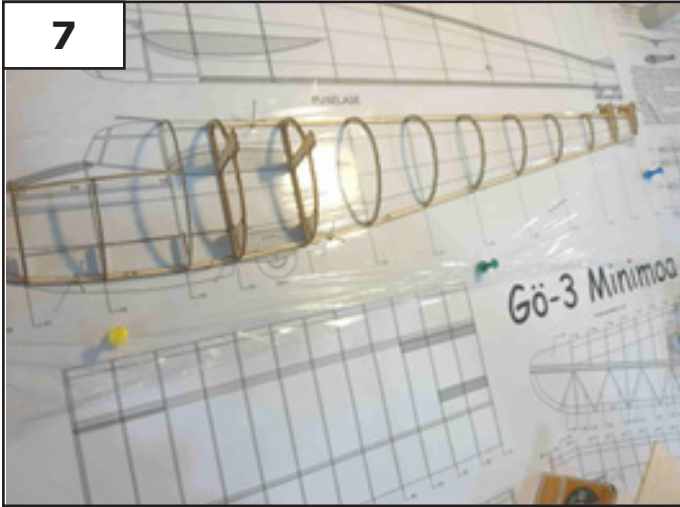

3. Rumpf

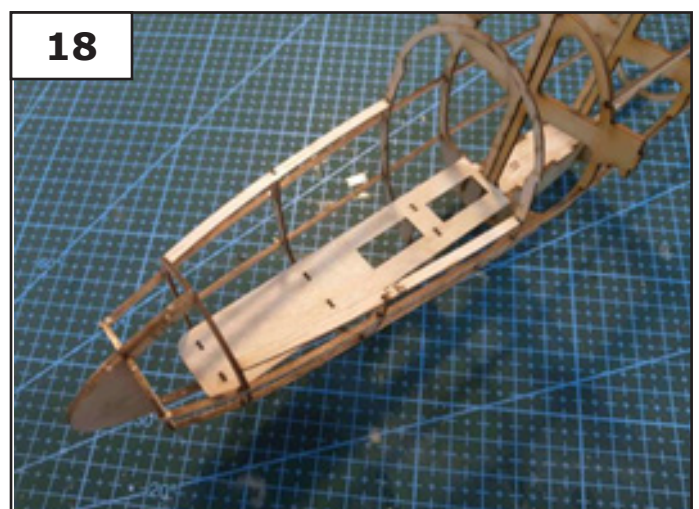
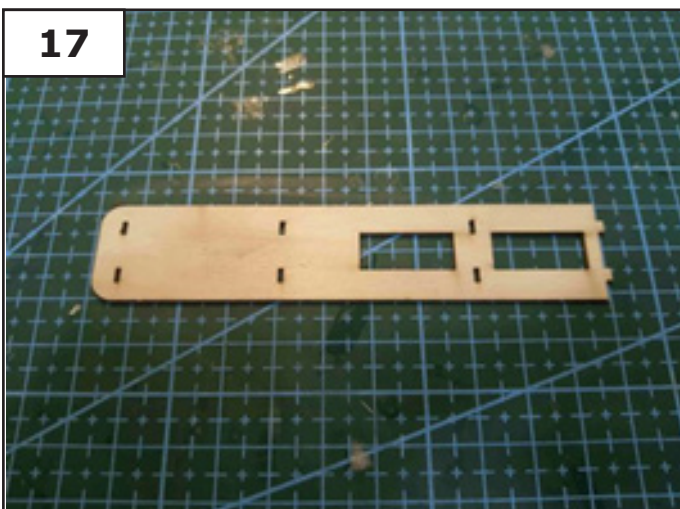
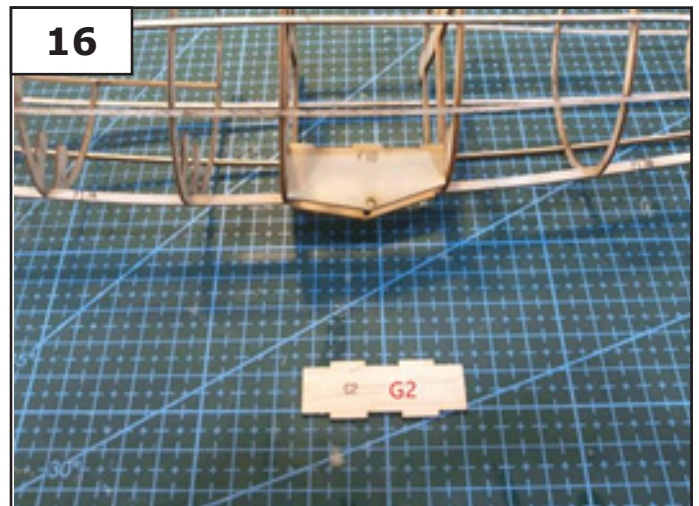
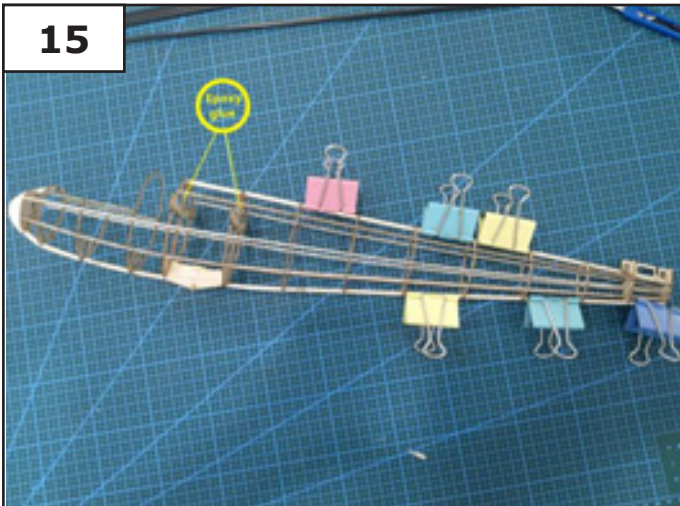
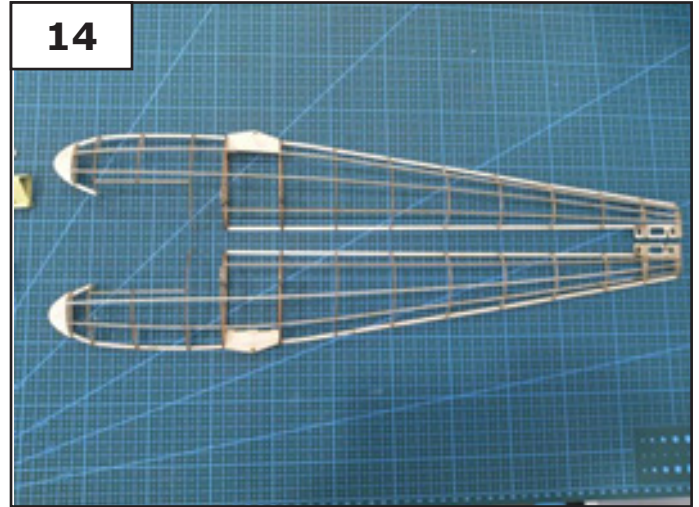

3. Rumpf

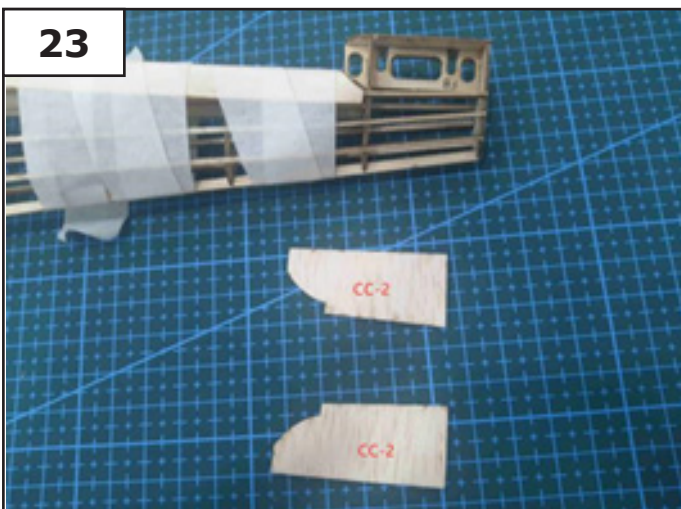
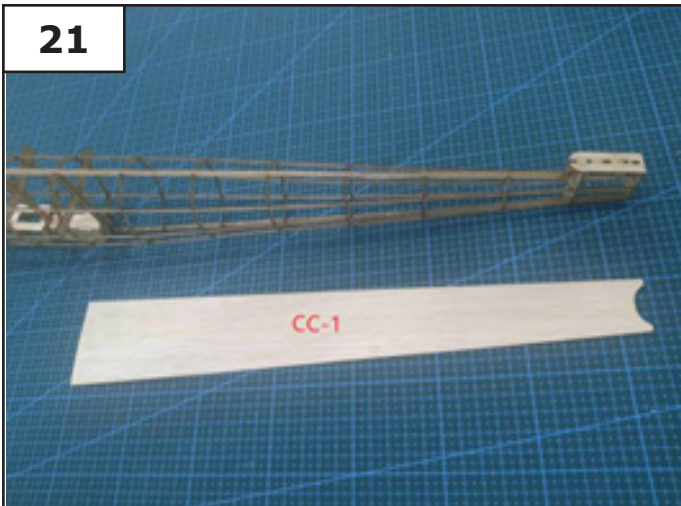
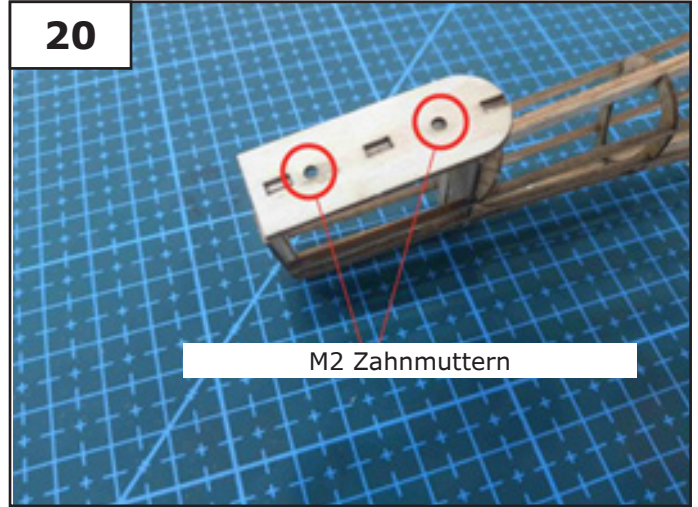
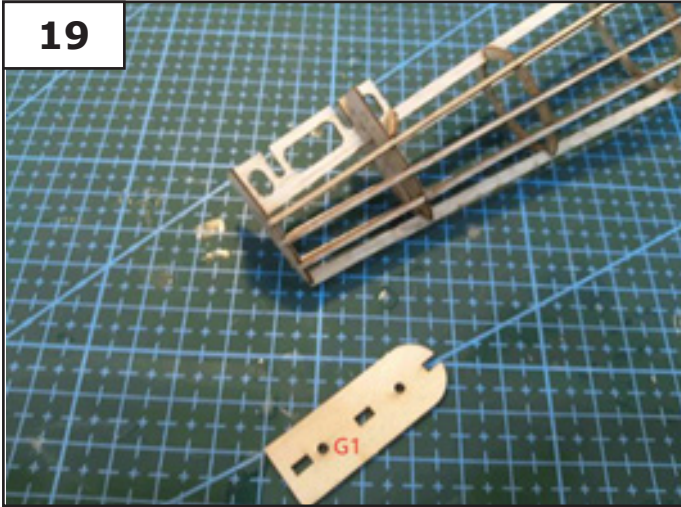

3. Rumpf

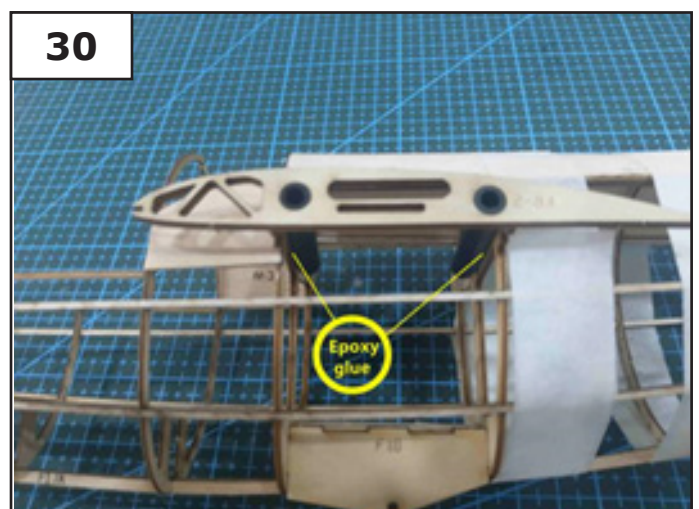
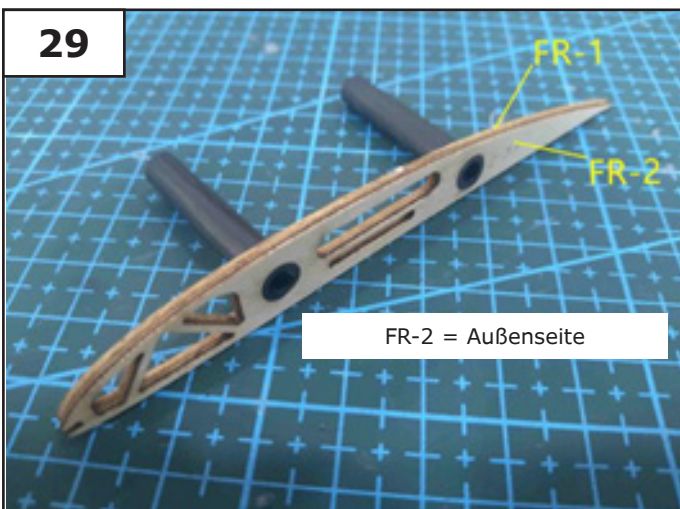
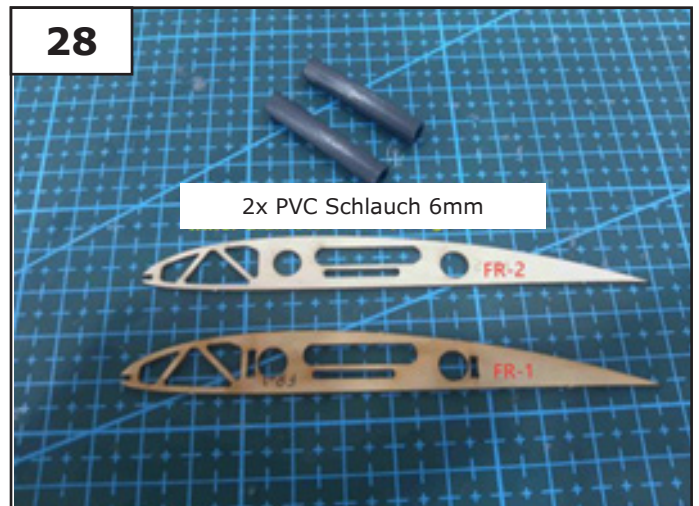
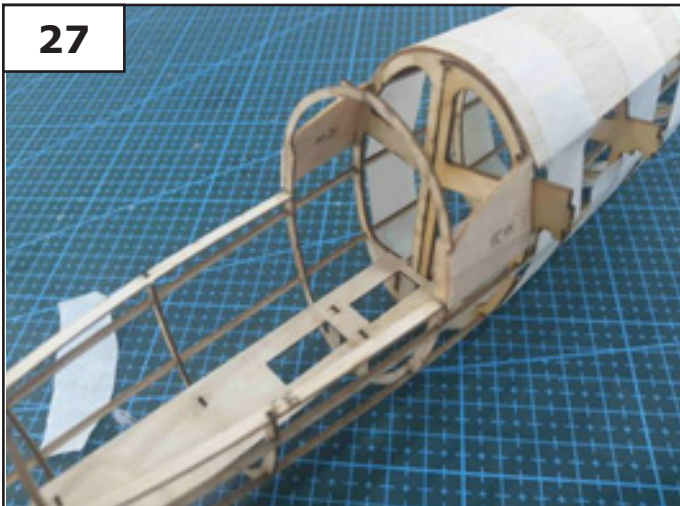
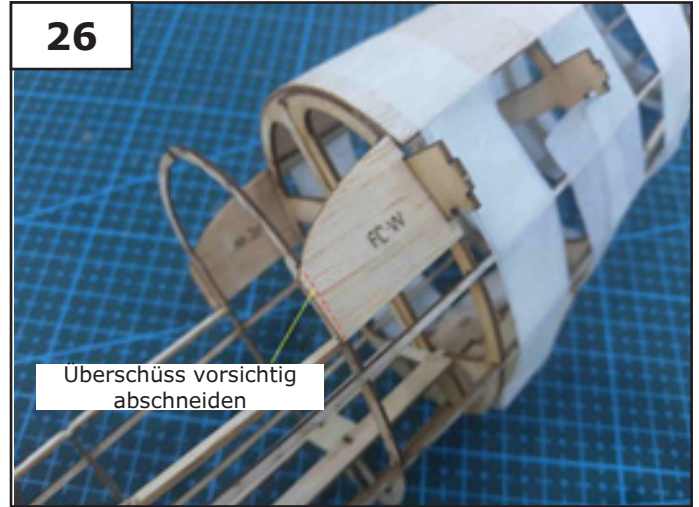
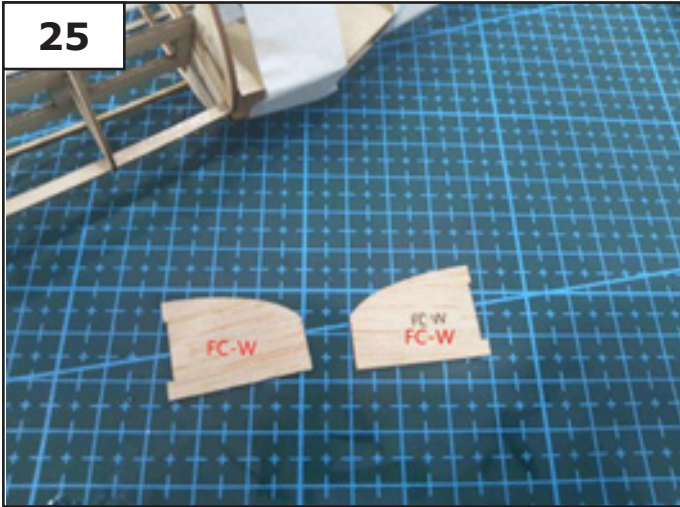

3. Rumpf

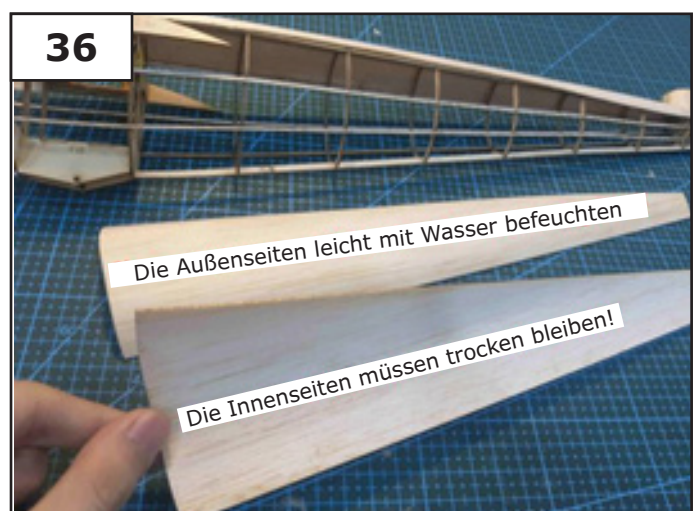
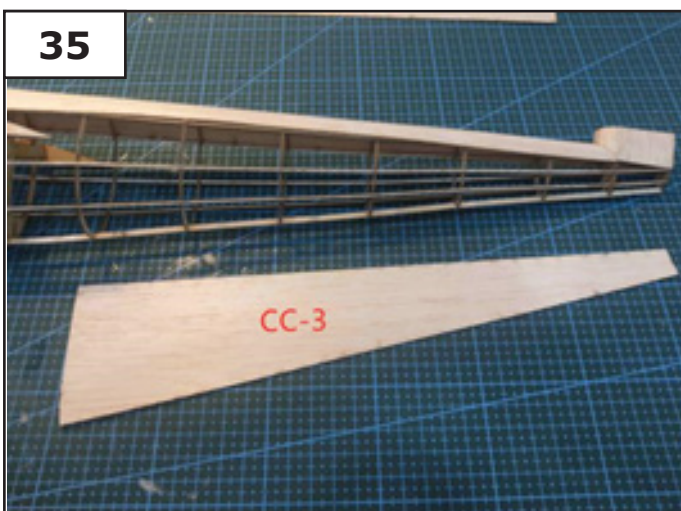
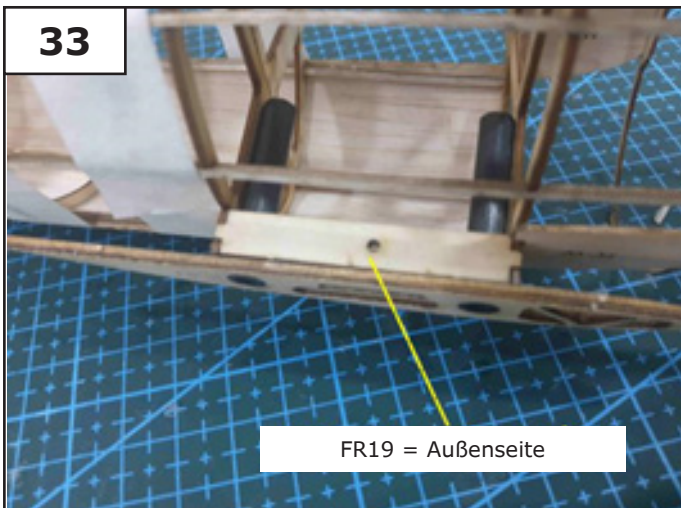
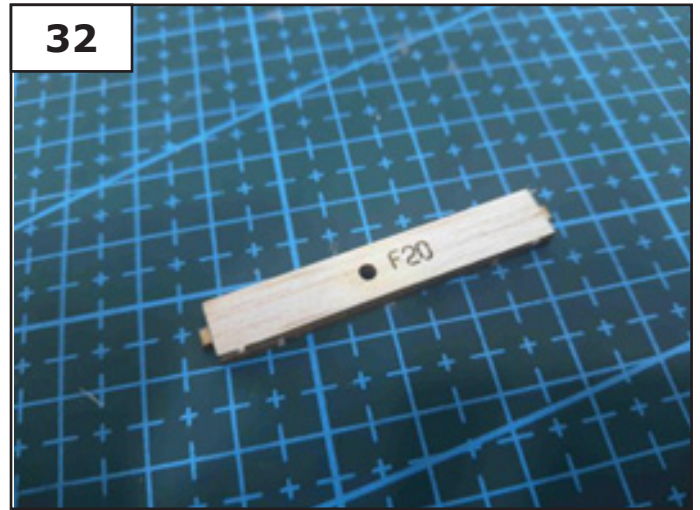
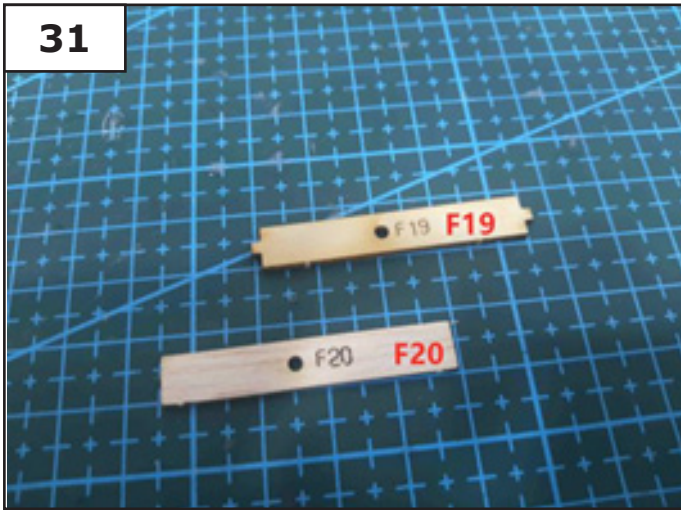

3. Rumpf

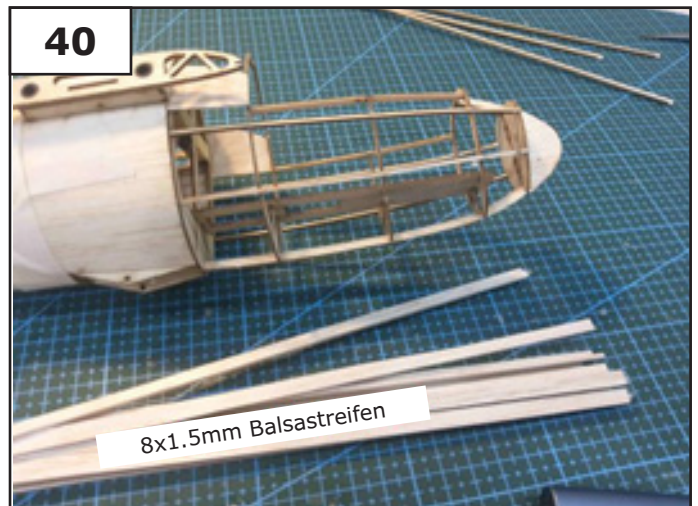
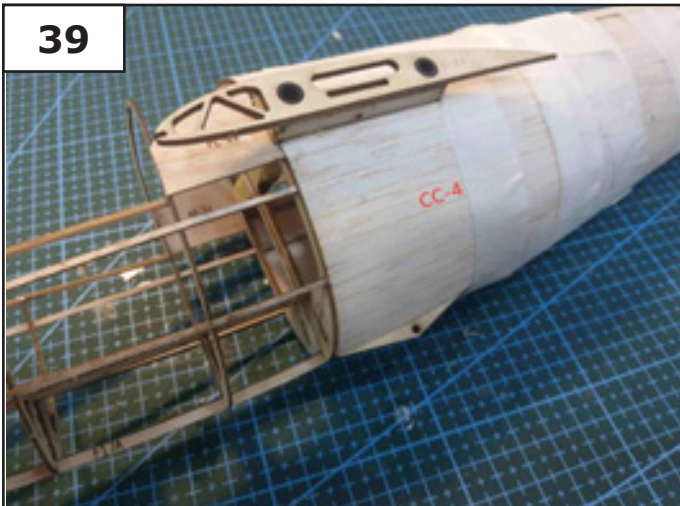
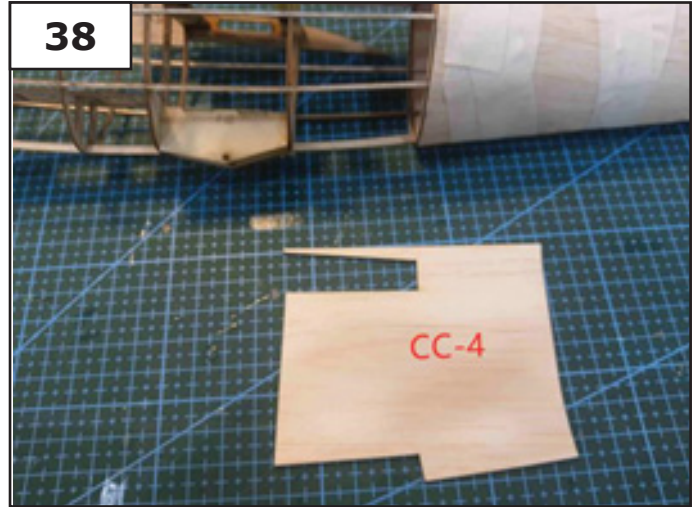
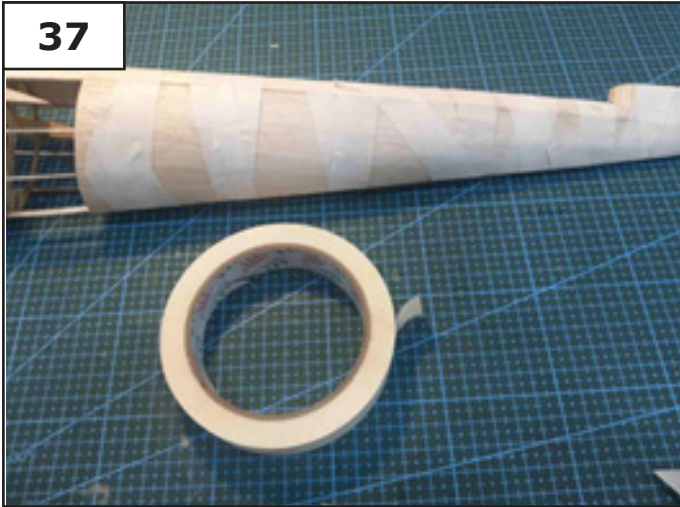

Klebe-Tipp:
Benutzen Sie CA-Kleber nur für die Enden der Streifen, sowie für den Kontakt an den anderen Rumpfteilen.
Für die Verbindung zwischen den einzelnen Streifen benutzen Sie Latex-Kleber

3. Rumpf

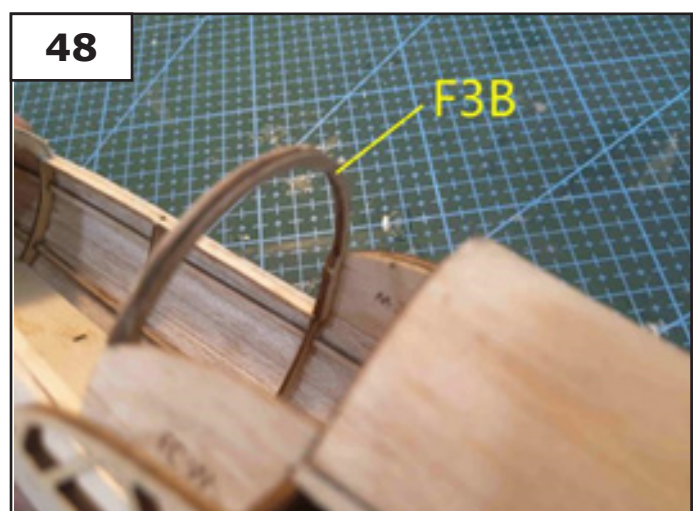
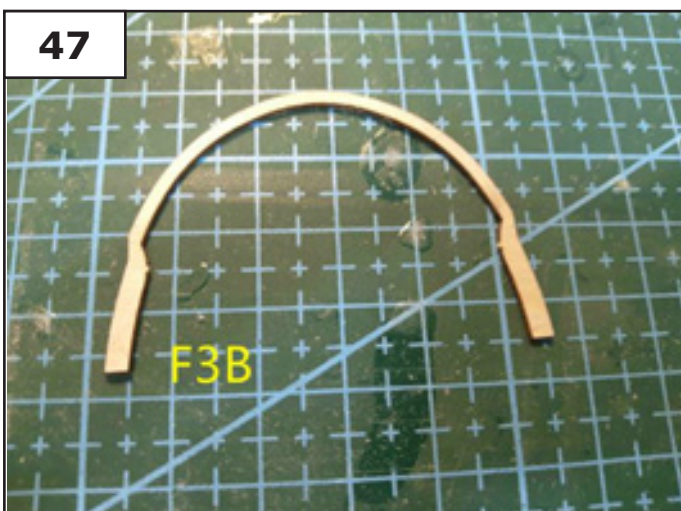
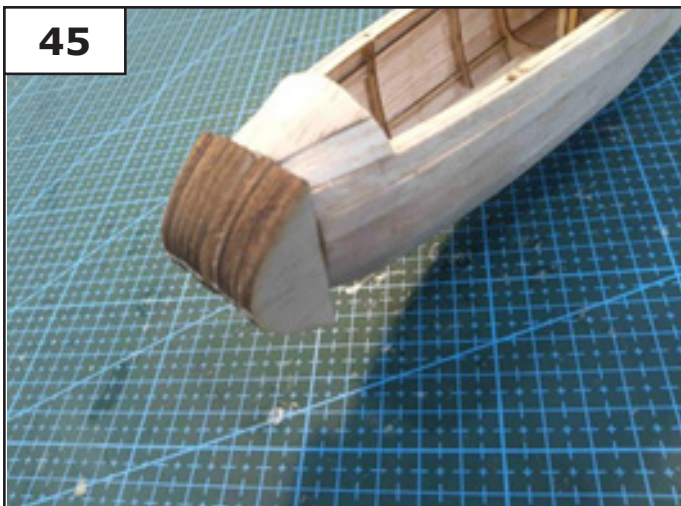
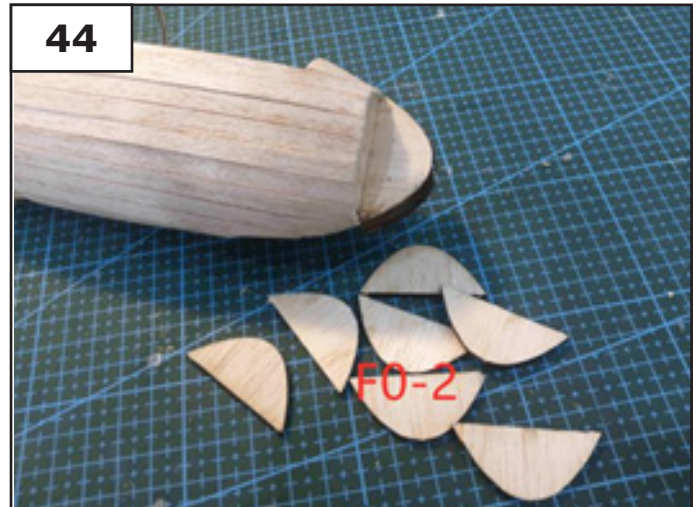

3. Rumpf

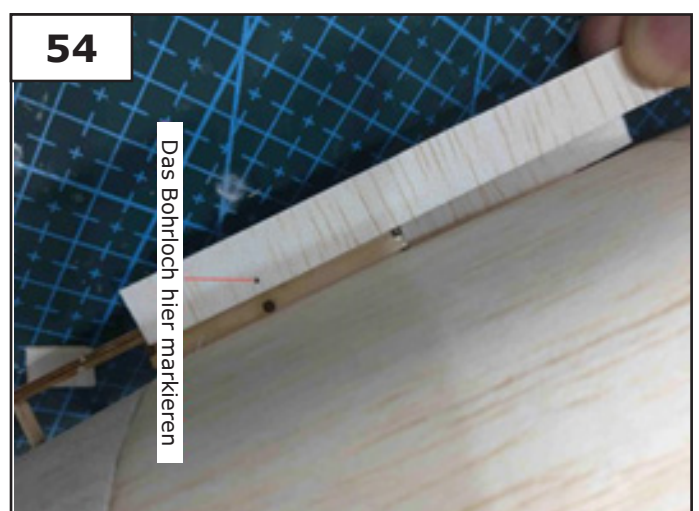
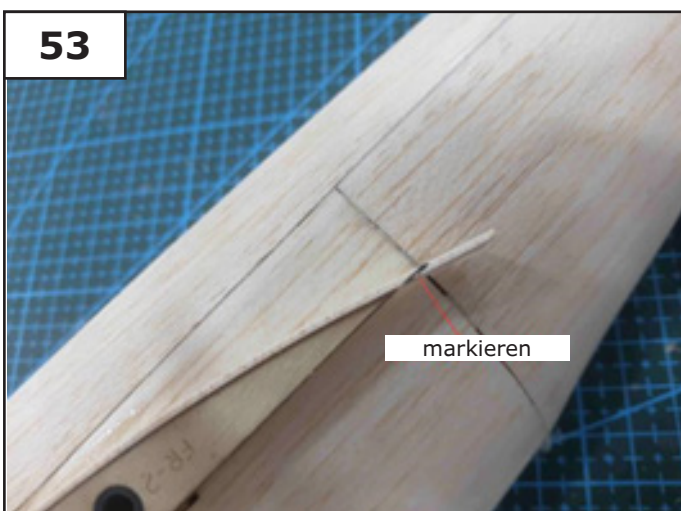
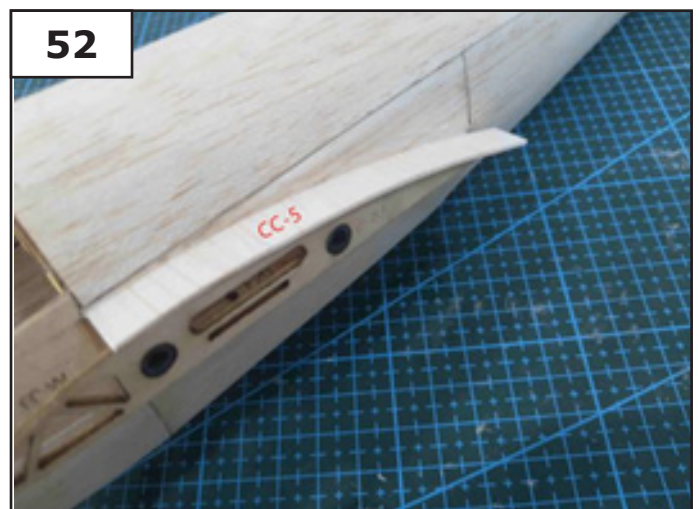
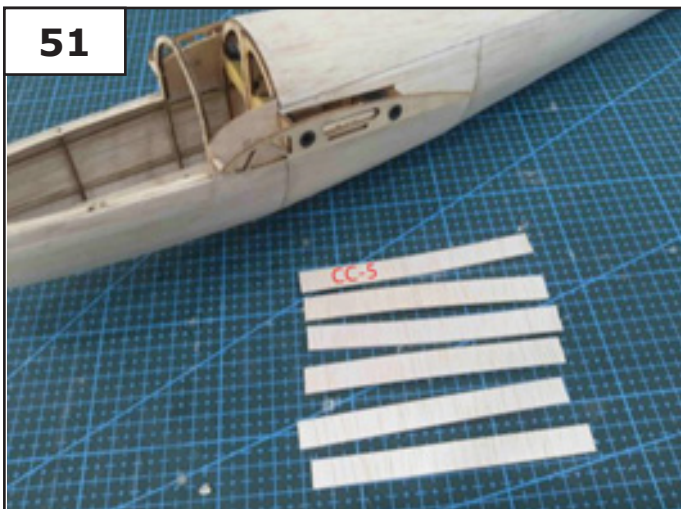
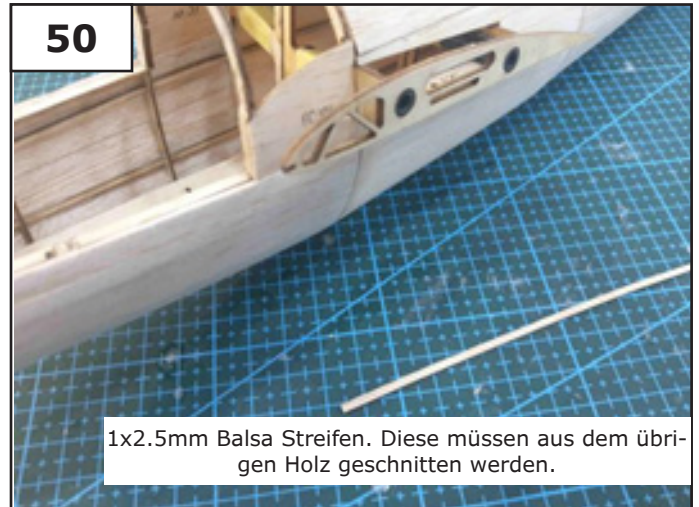
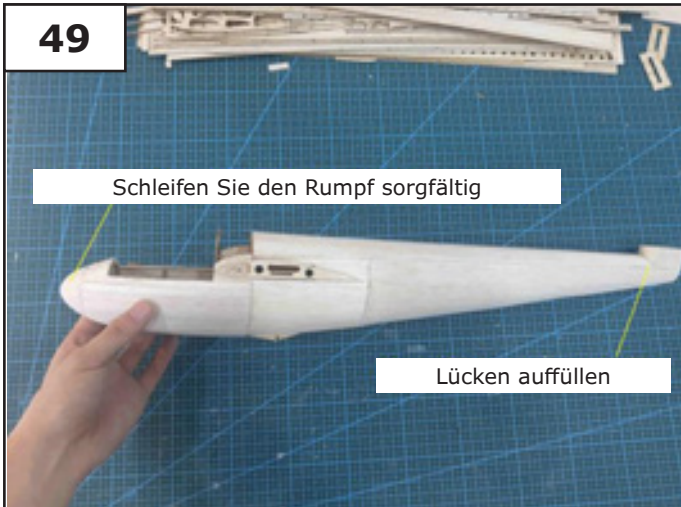

3. Rumpf

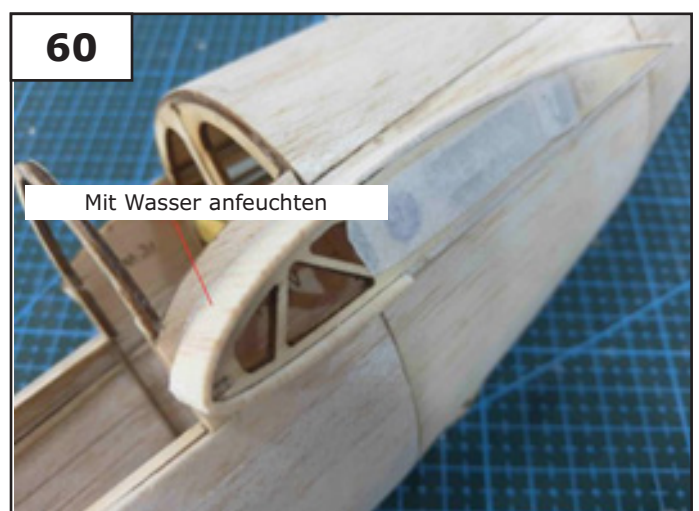
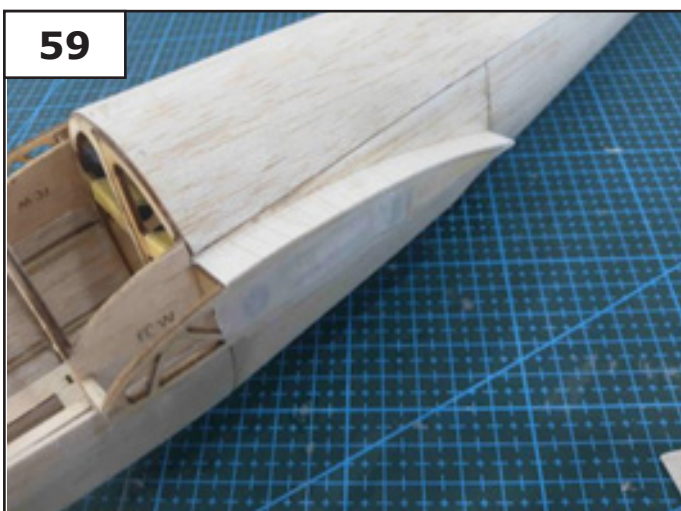
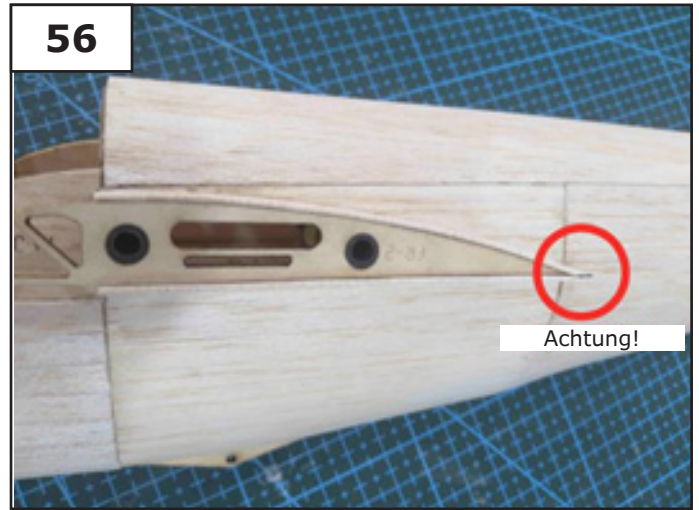
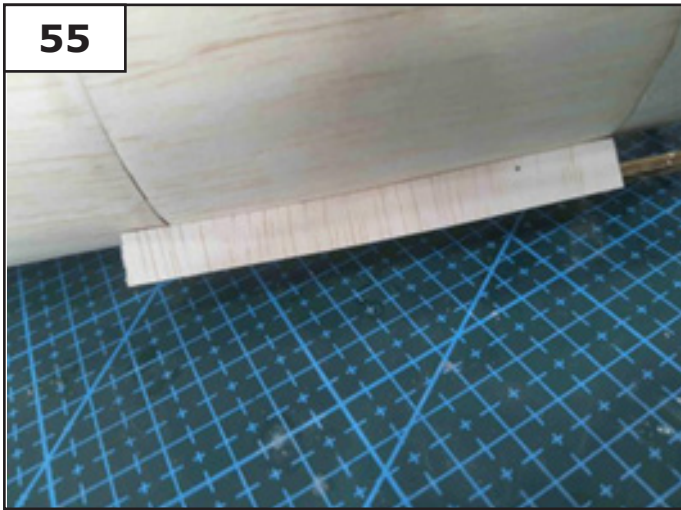

3. Rumpf

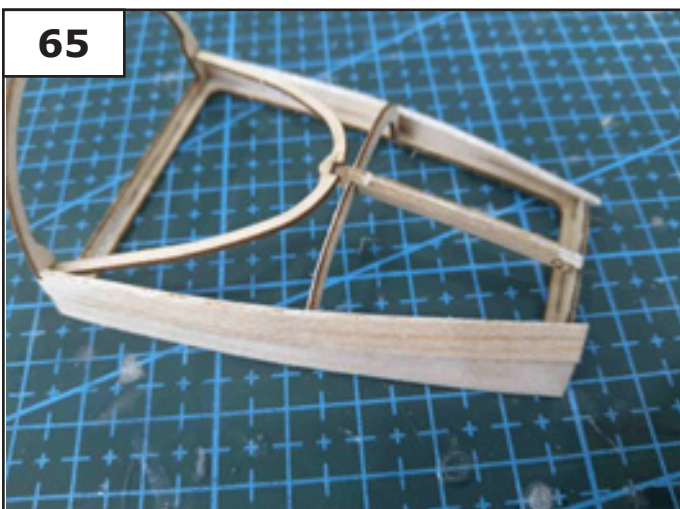
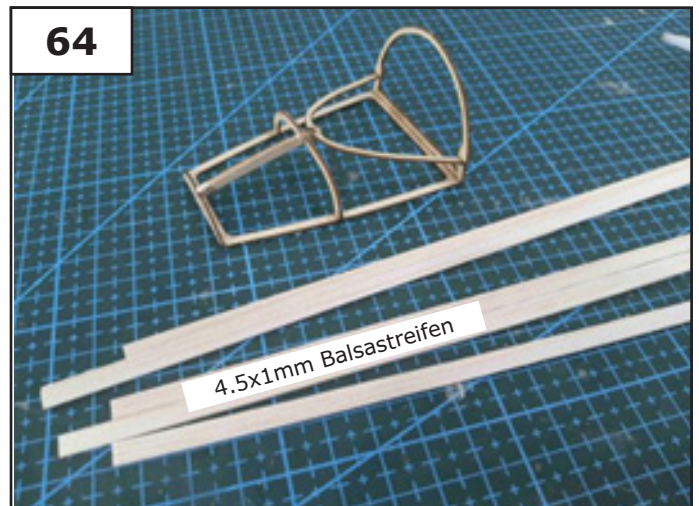
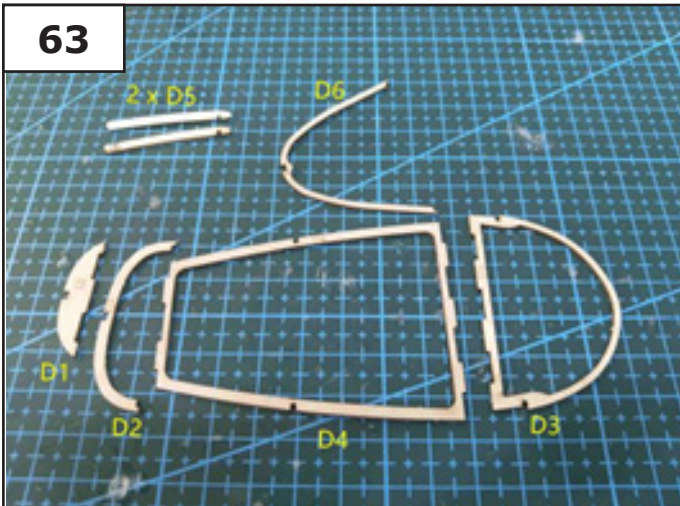
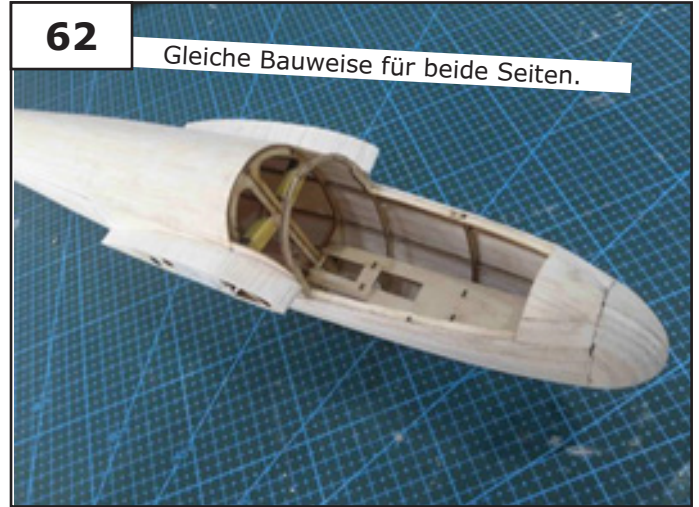
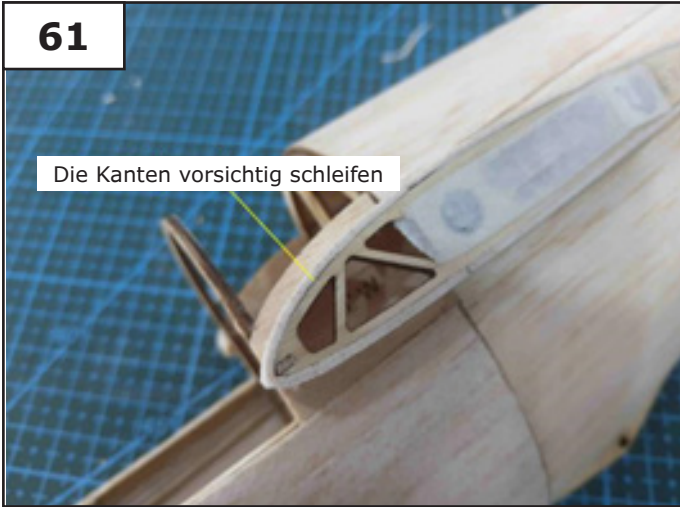

3. Rumpf

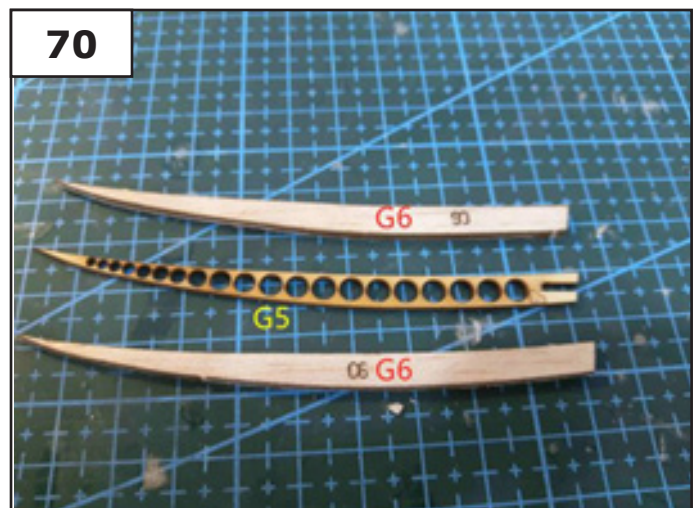
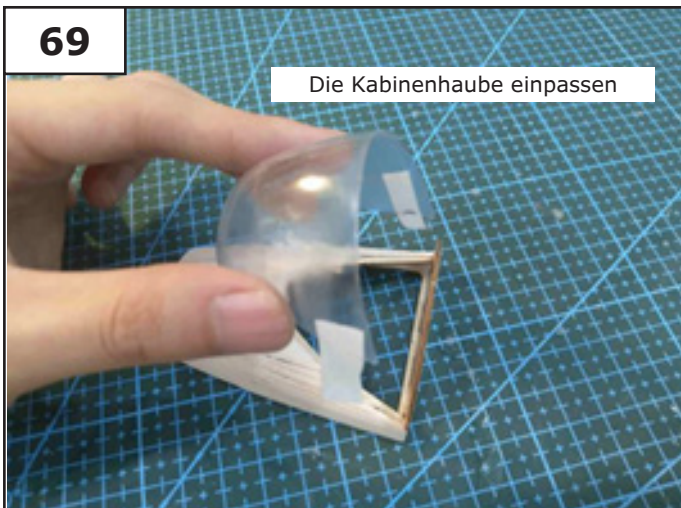
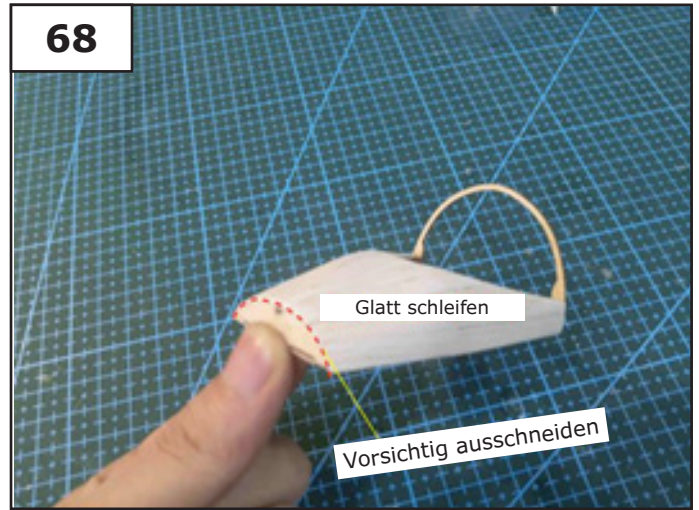
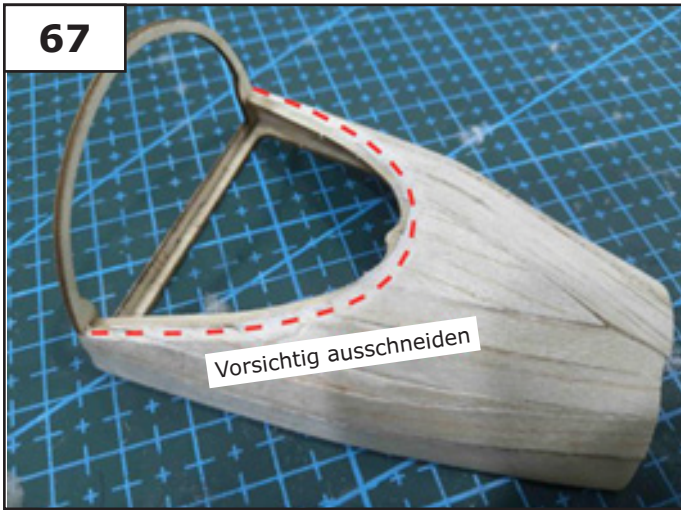

3. Rumpf

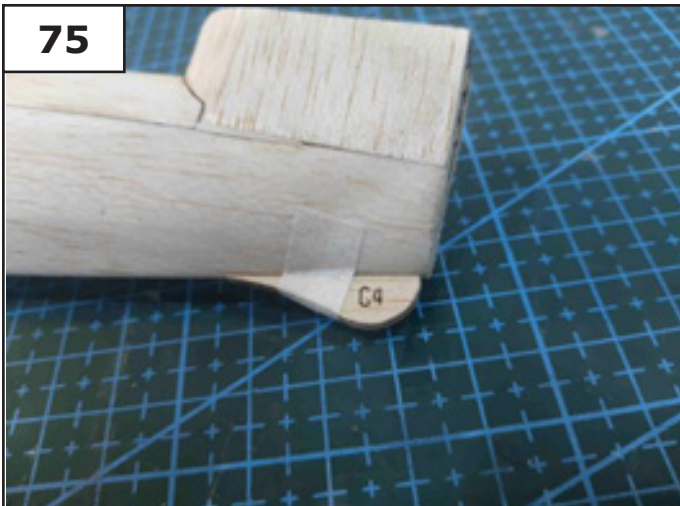
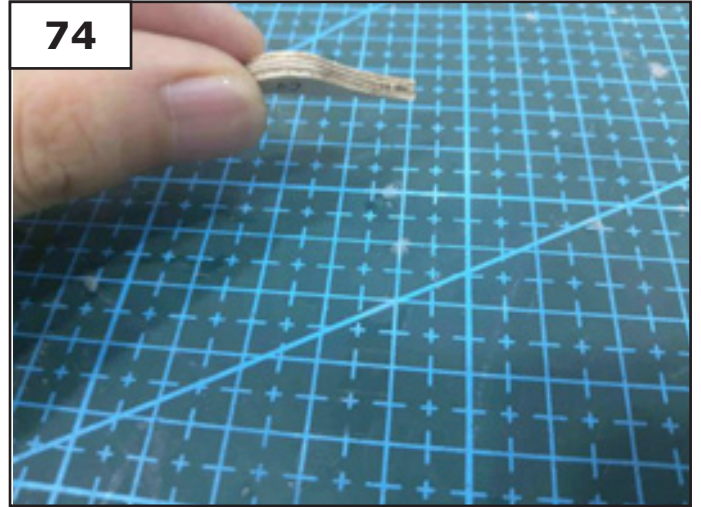
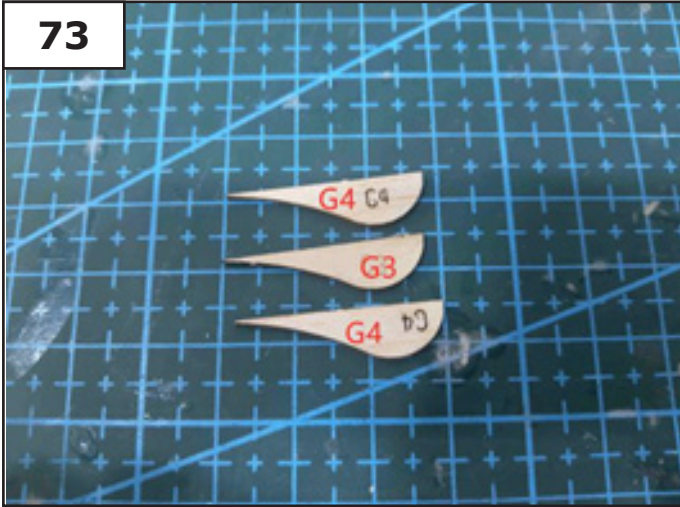

Notizen:

4. Tragflächen-Mittelstück

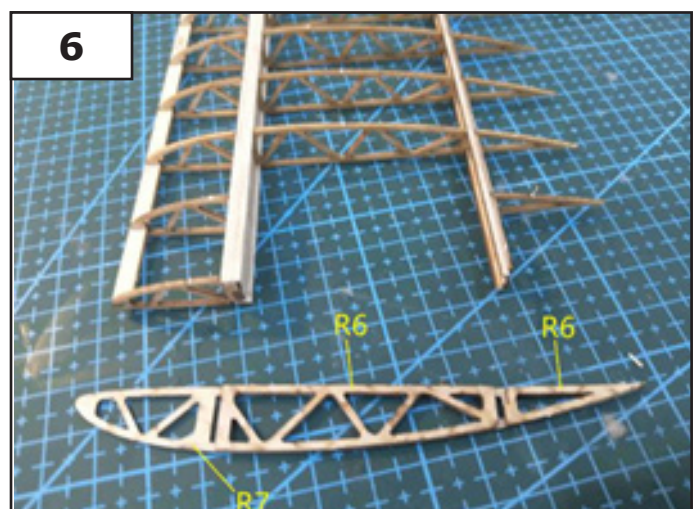
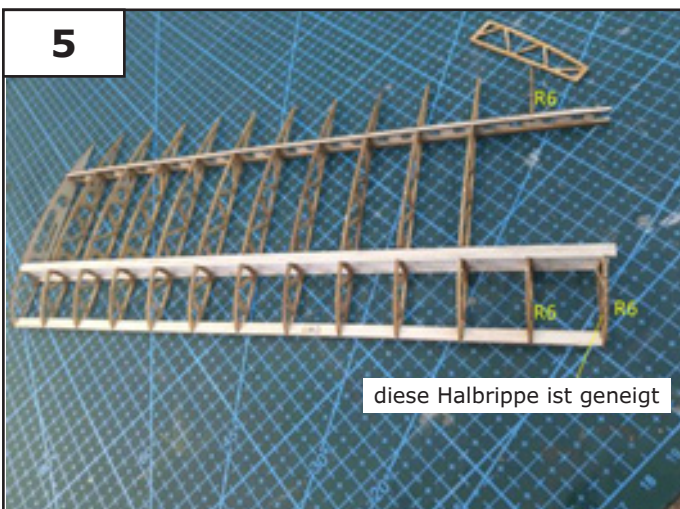
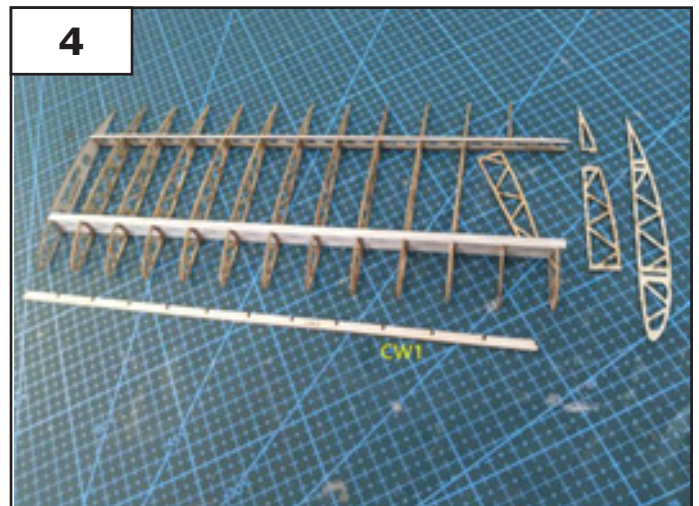
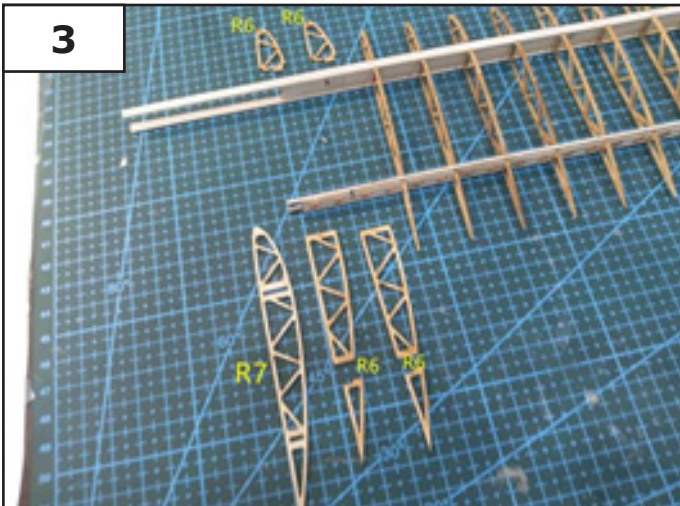
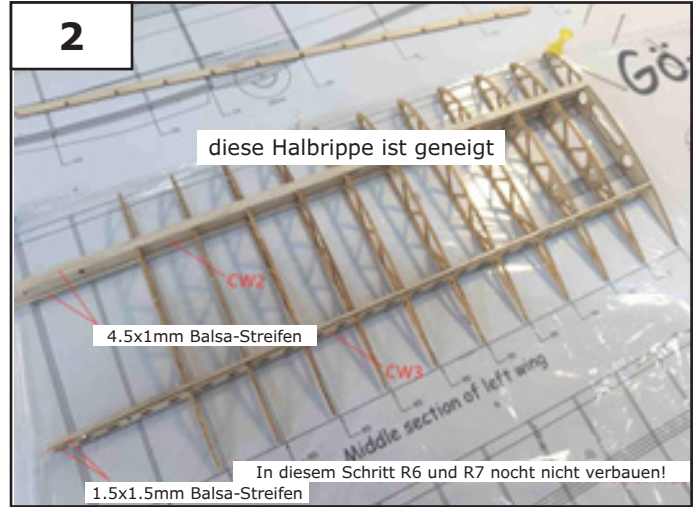
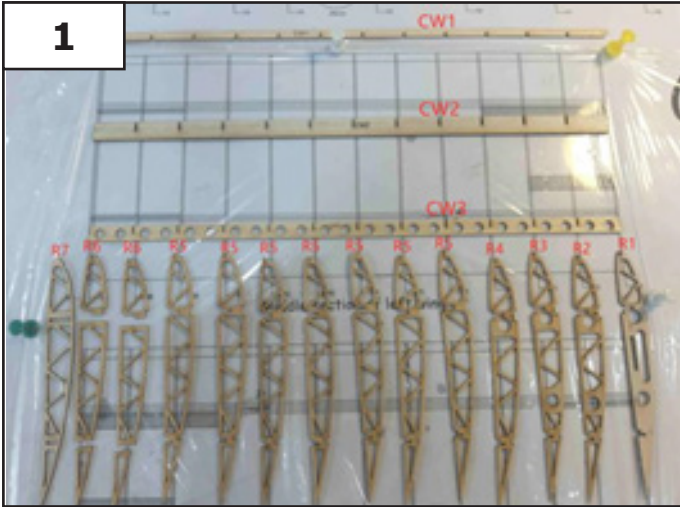

4. Tragflächen-Mittelstück

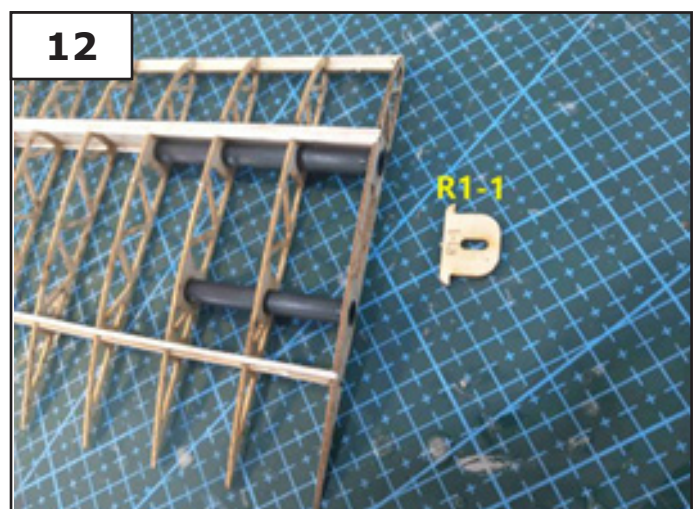
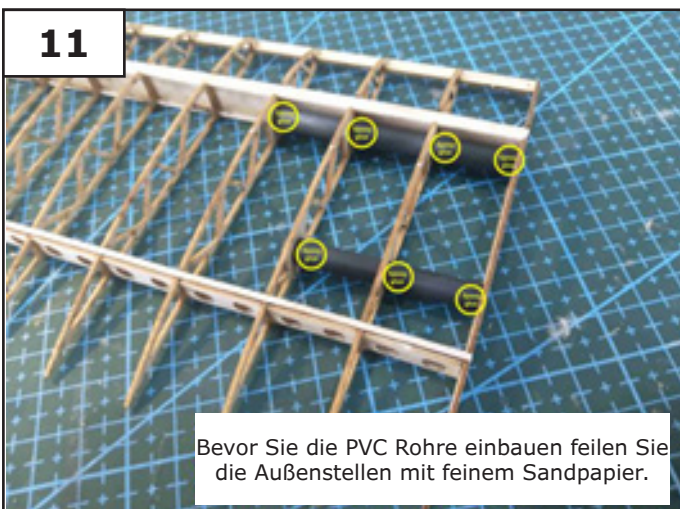
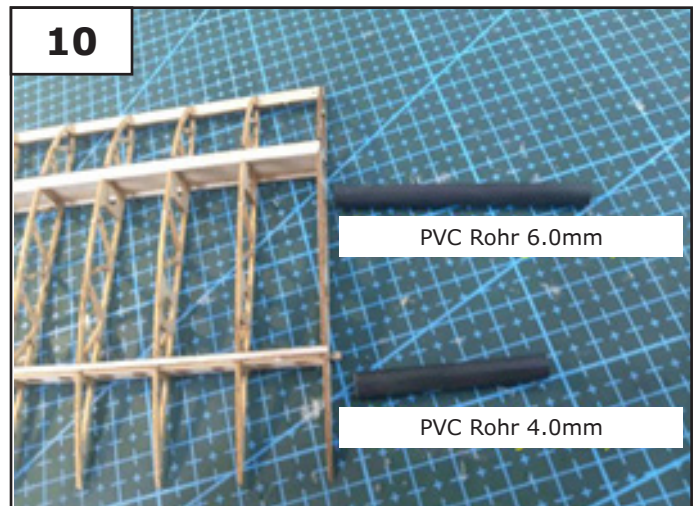
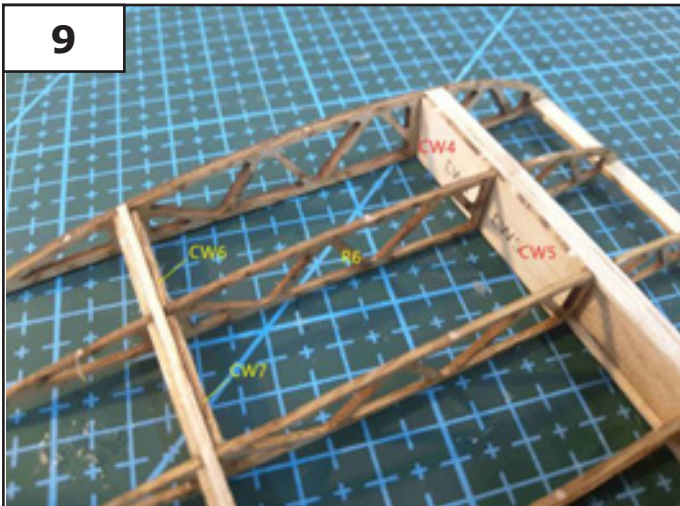
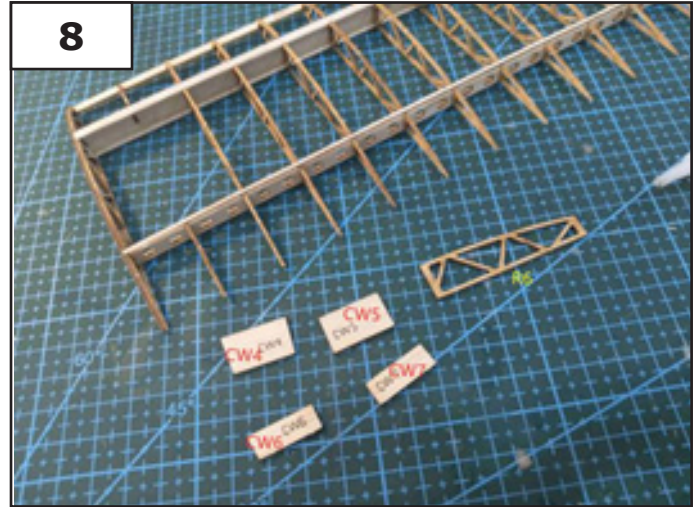
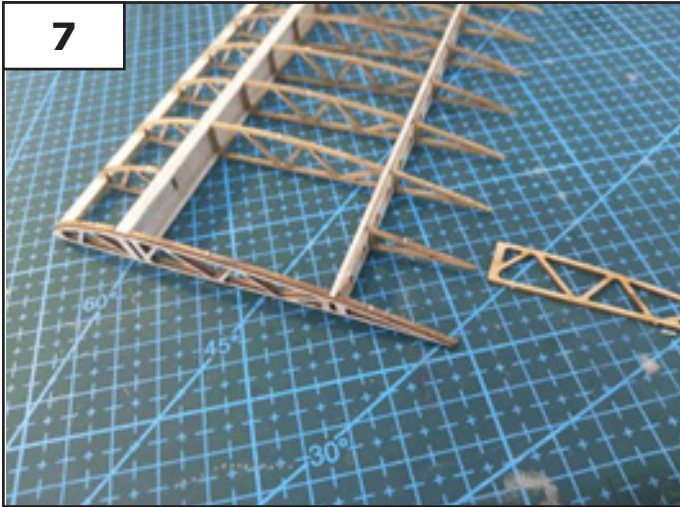

4. Tragflächen-Mittelstück

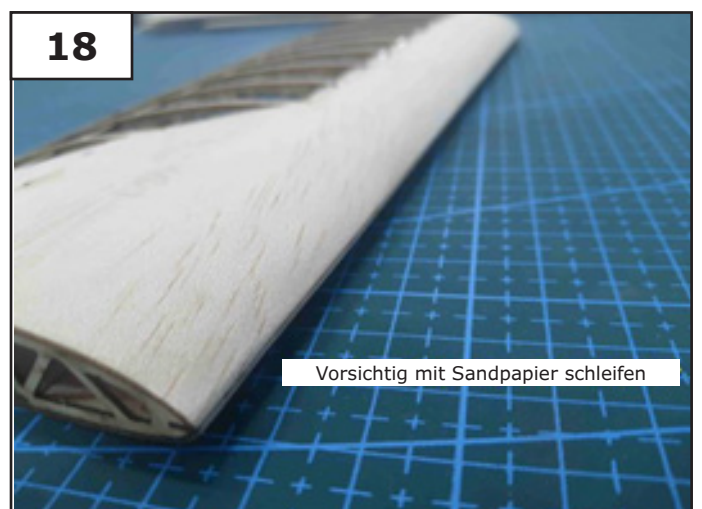
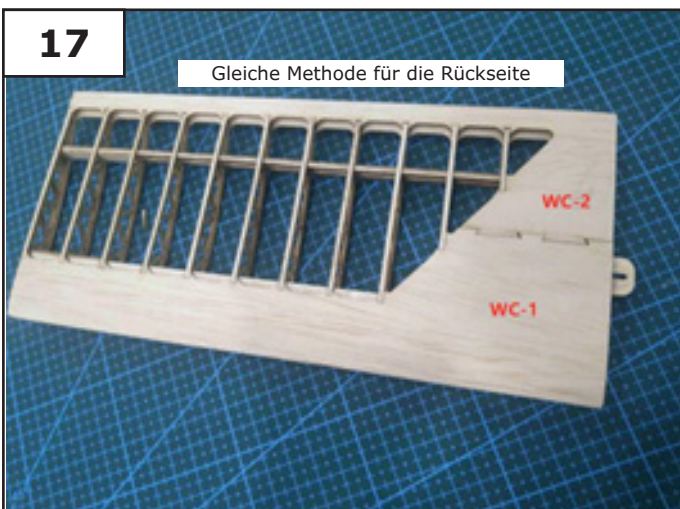
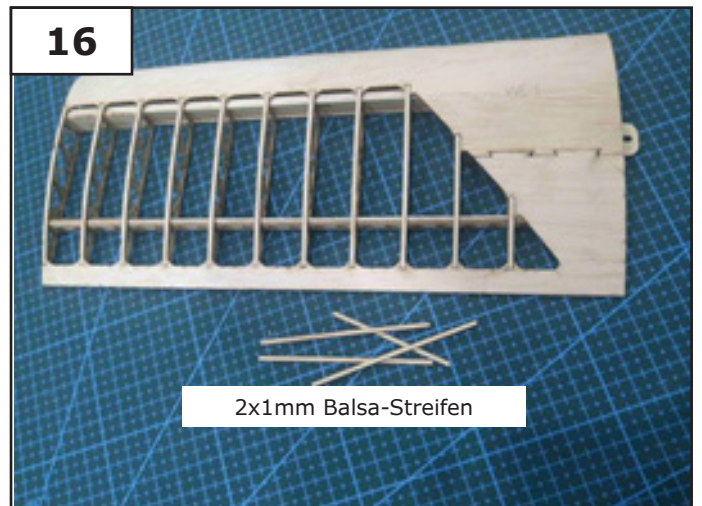
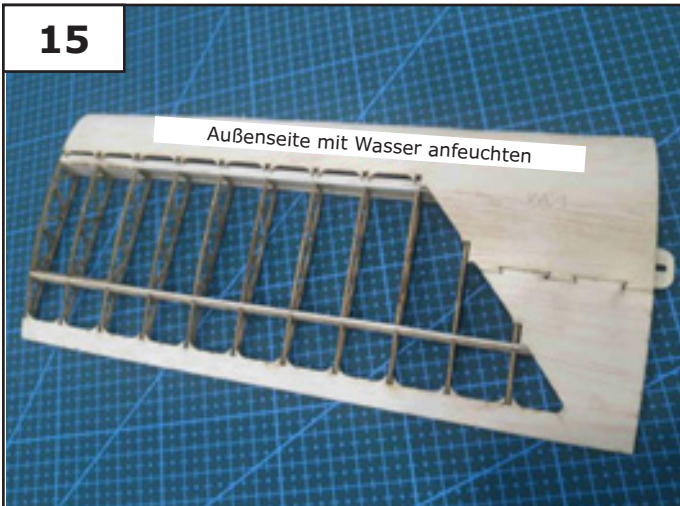
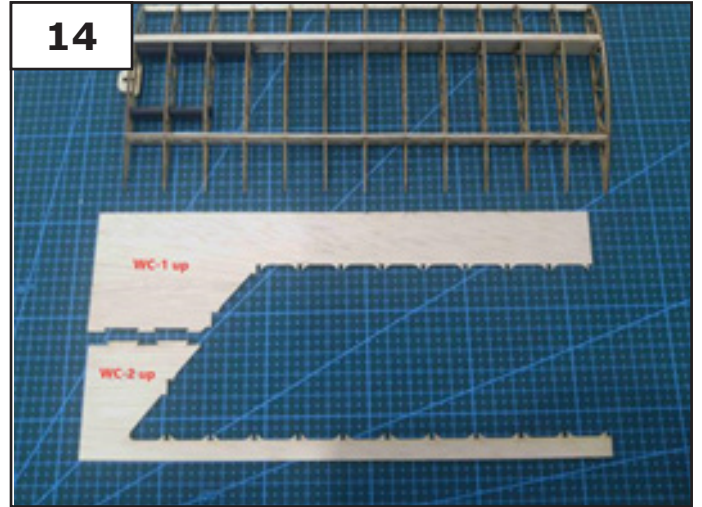
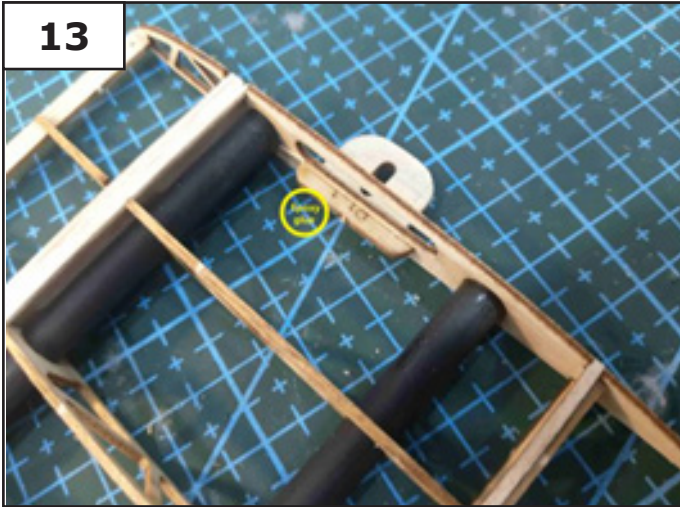

5. Tragflächen-Außen

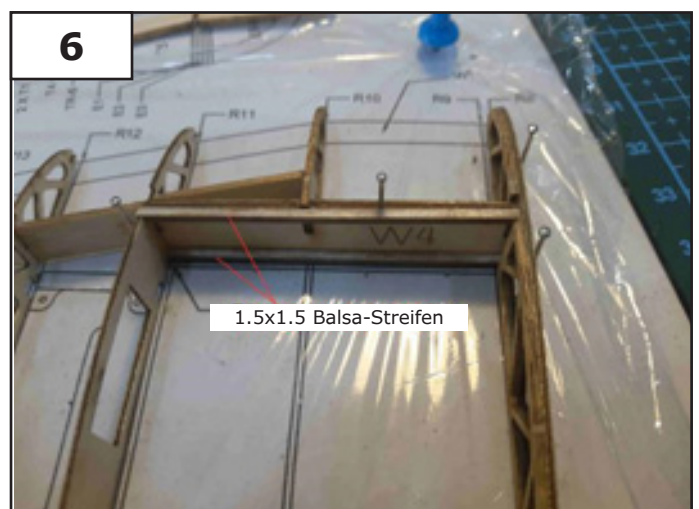
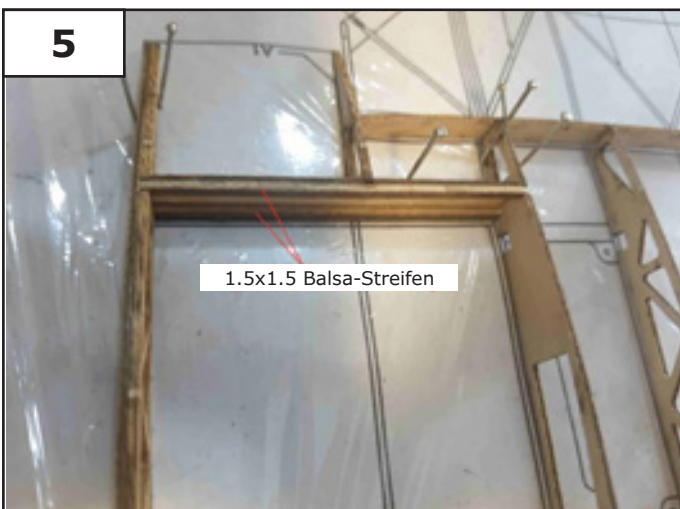
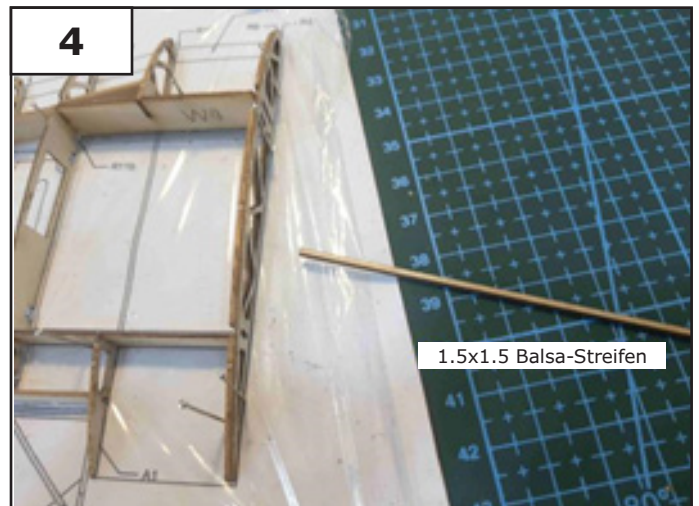
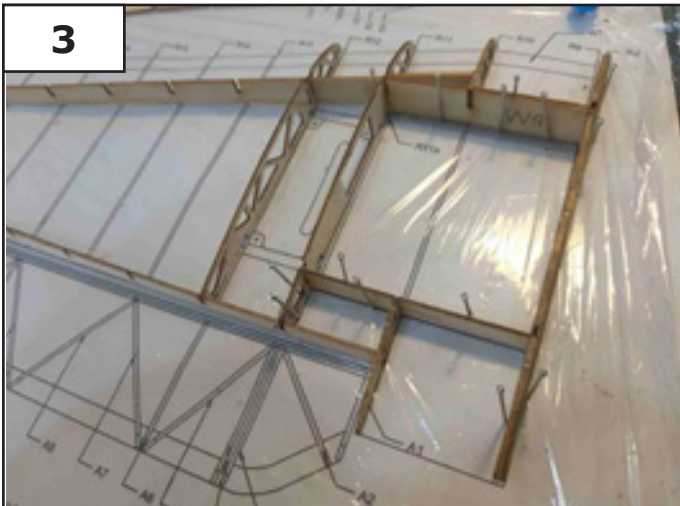
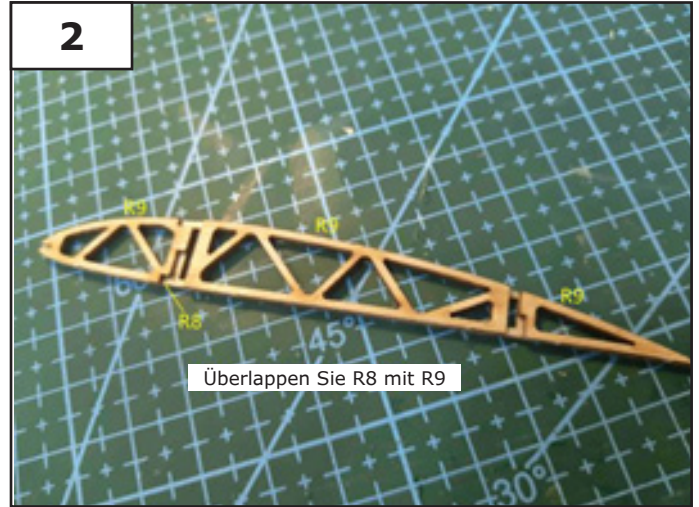
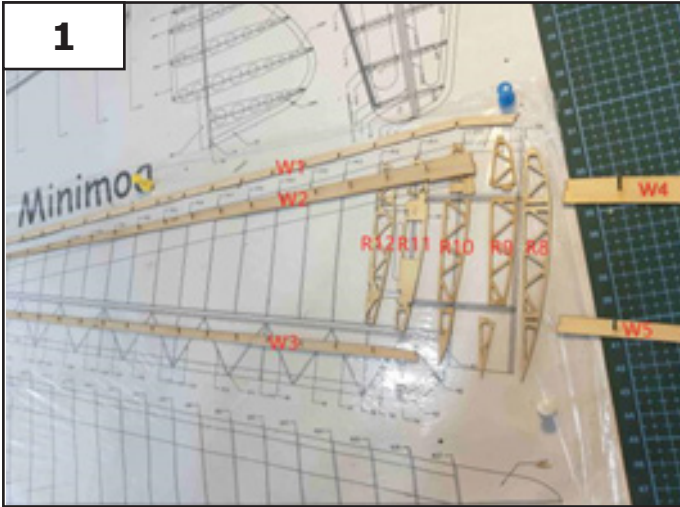

5. Tragflächen-Außen

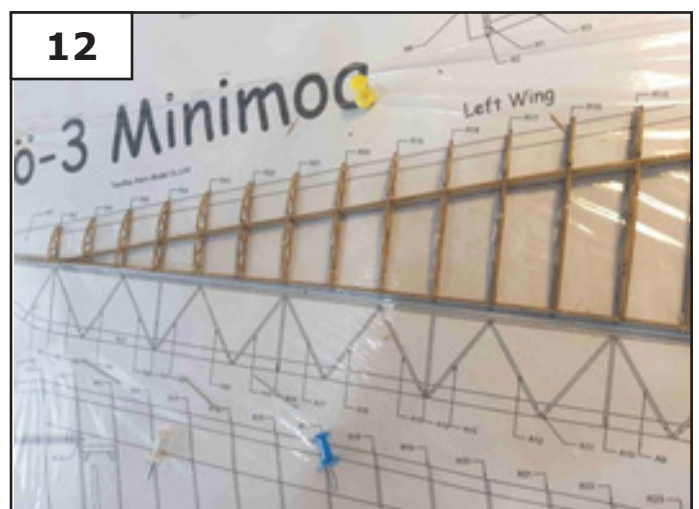
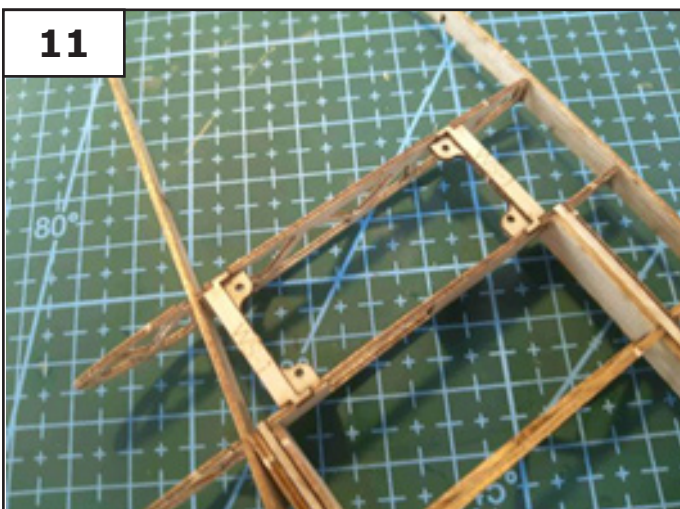
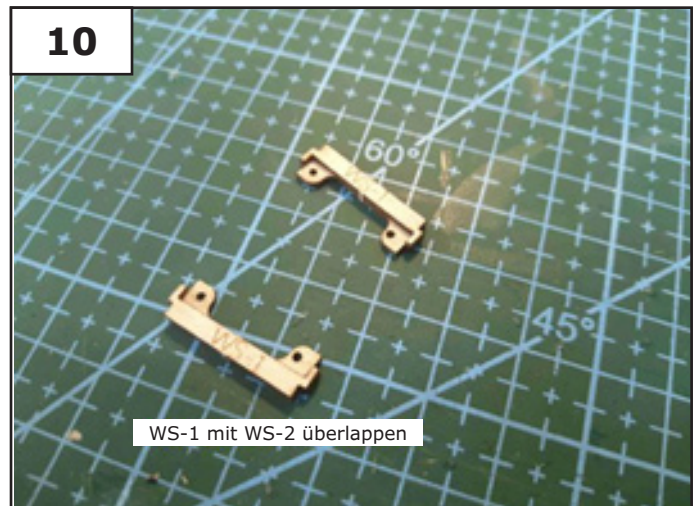
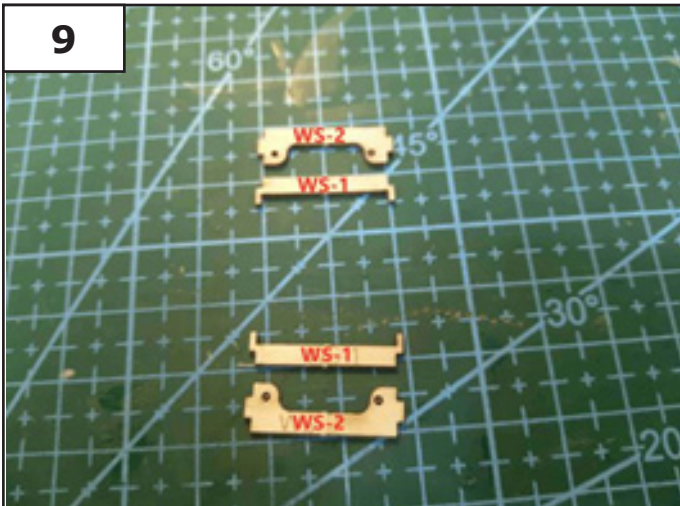
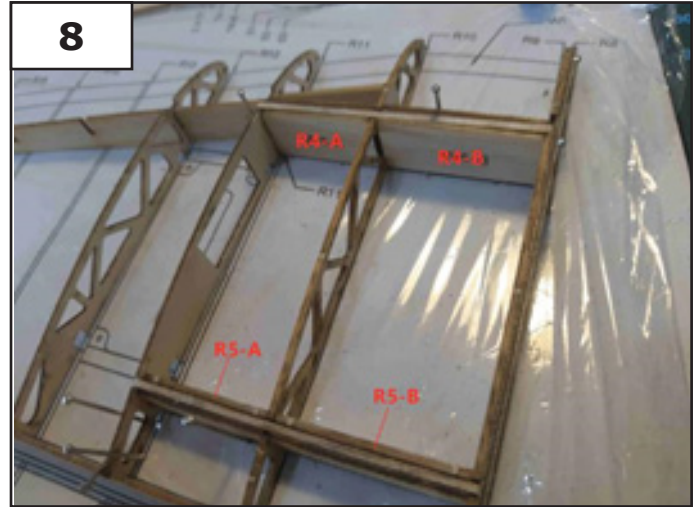
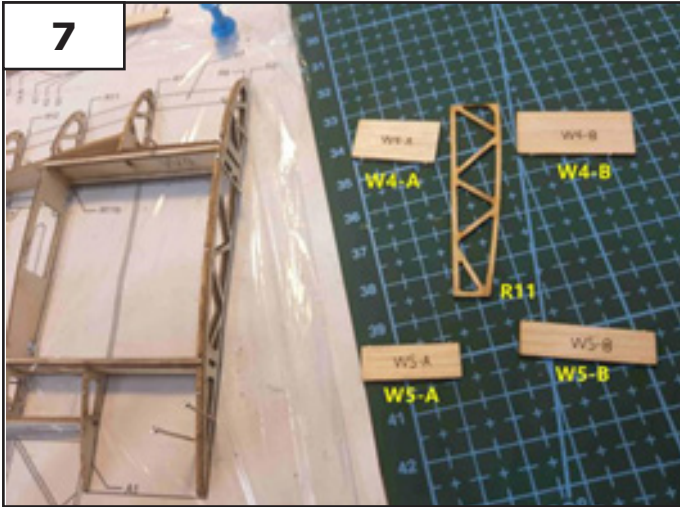

5. Tragflächen-Außen

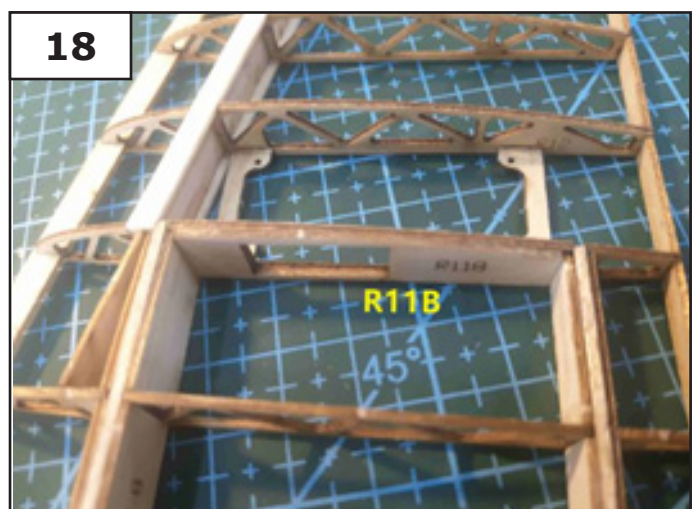
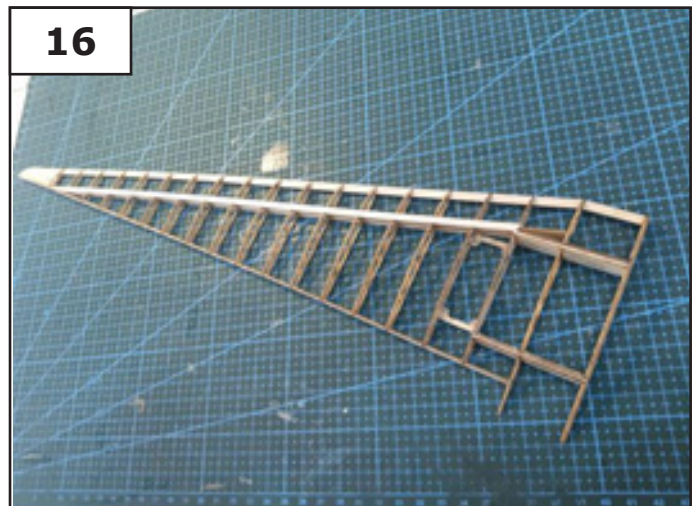
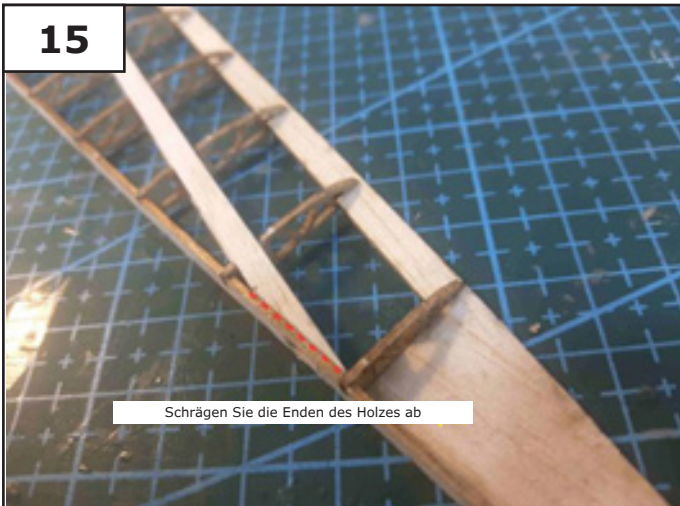
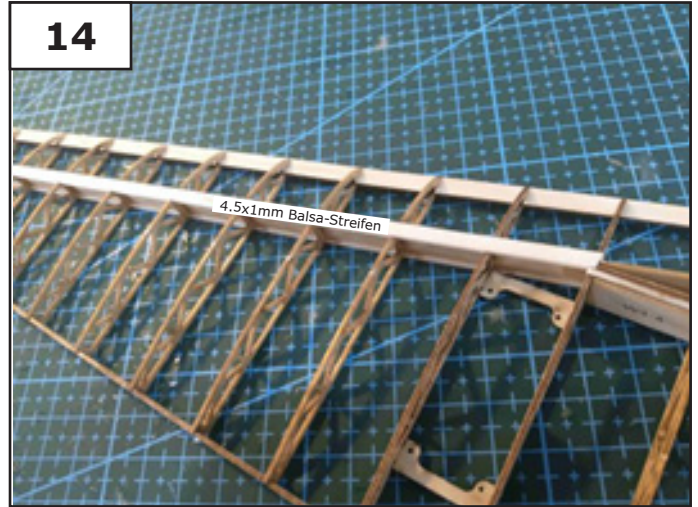
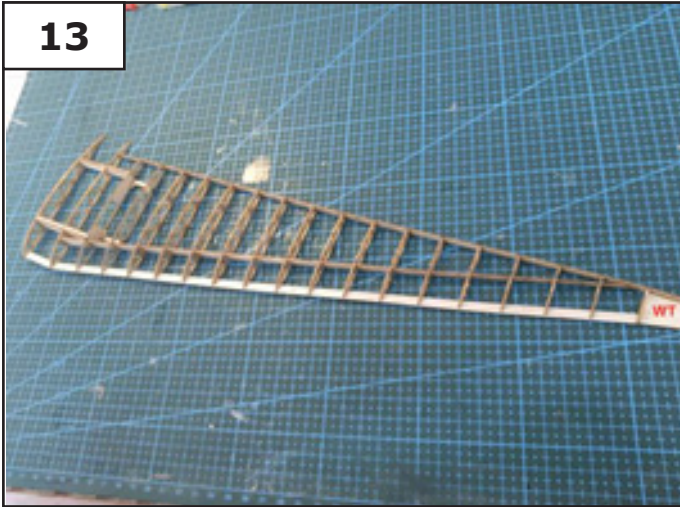

5. Tragflächen-Außen

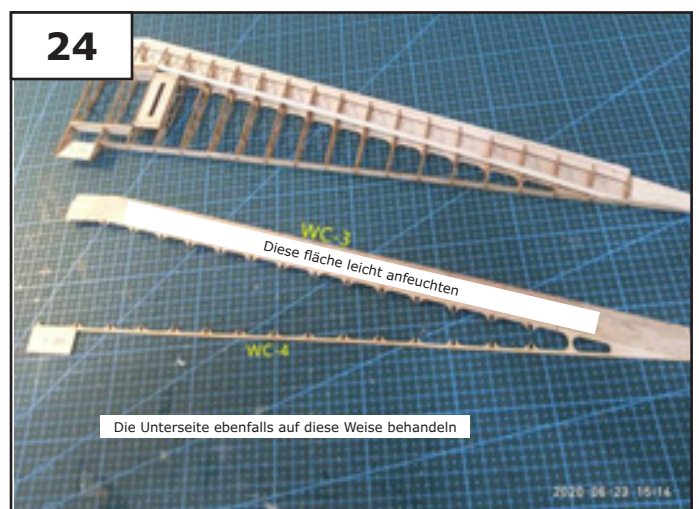
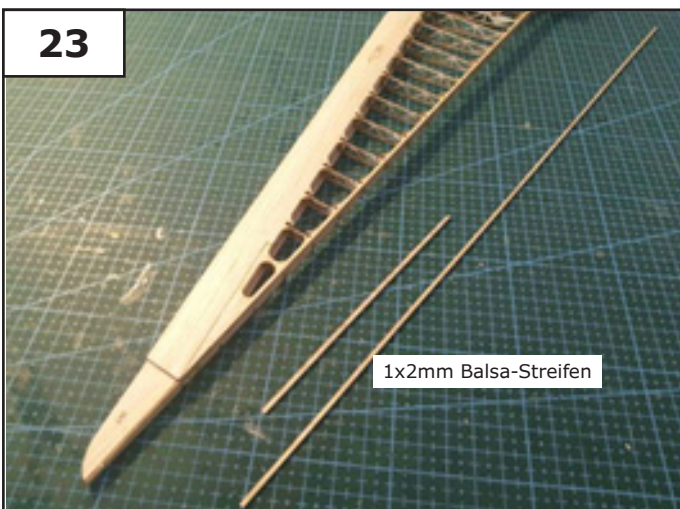
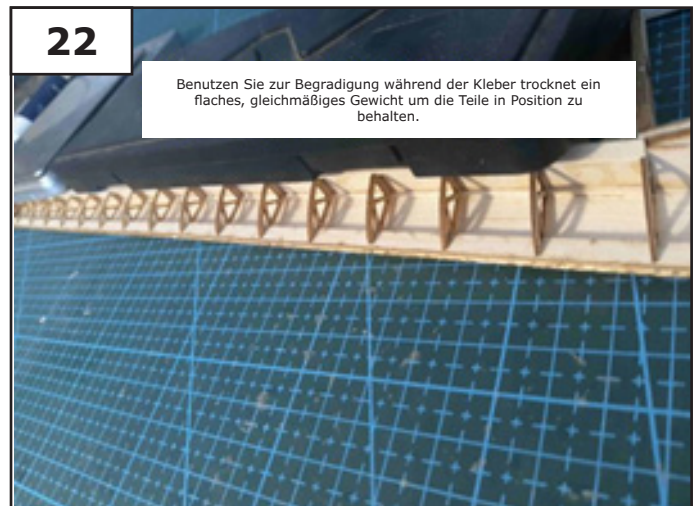
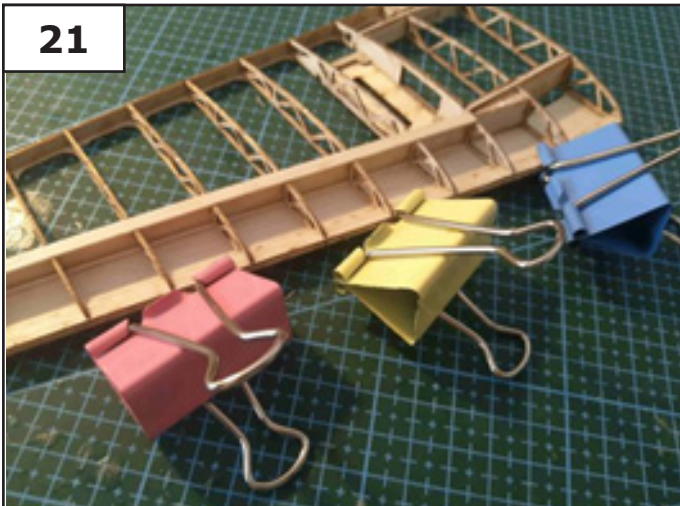
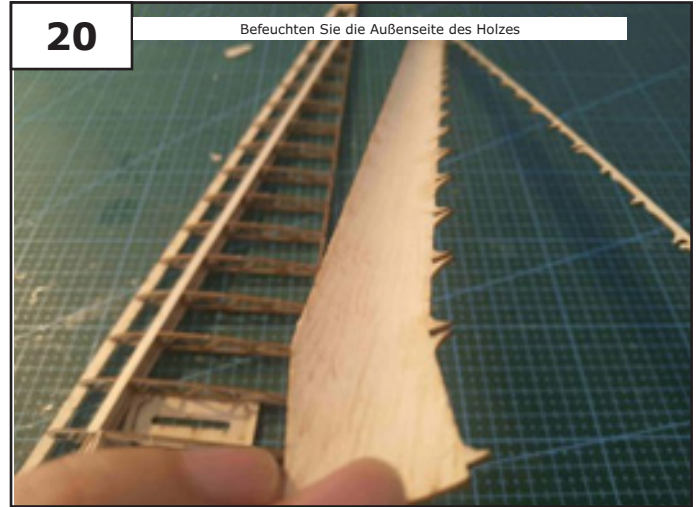
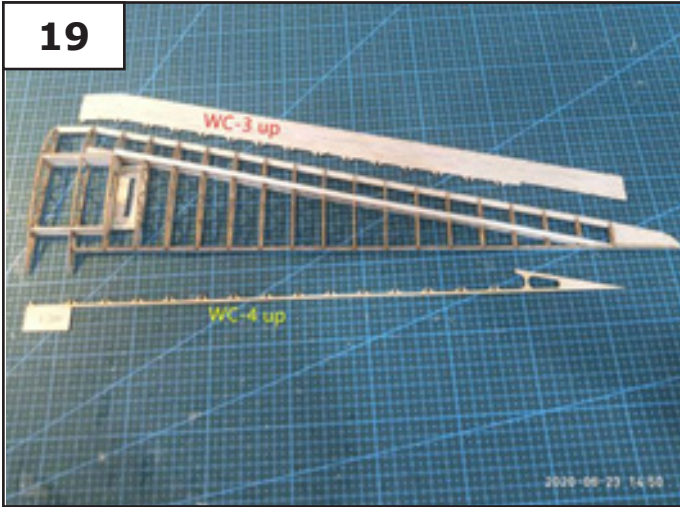

5. Tragflächen-Außen

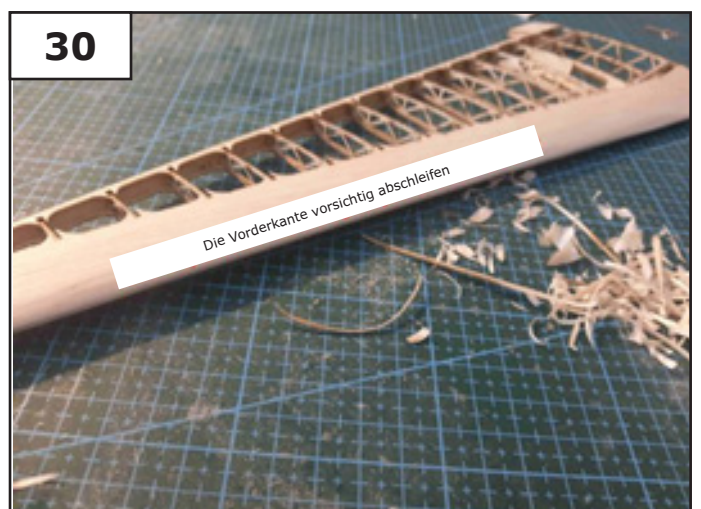
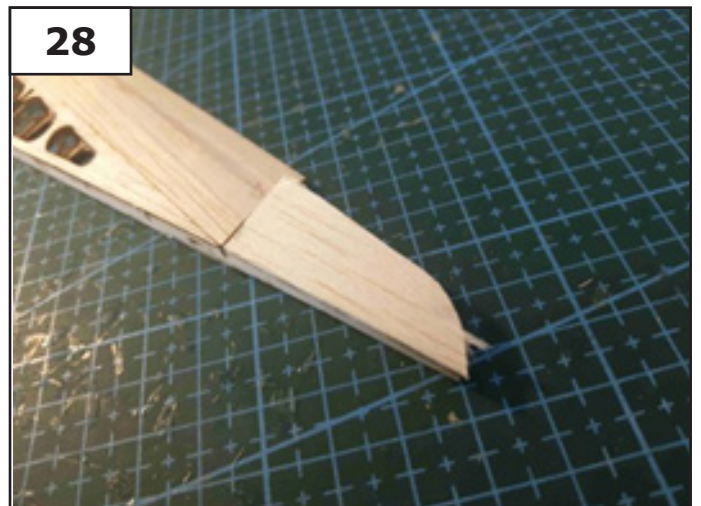
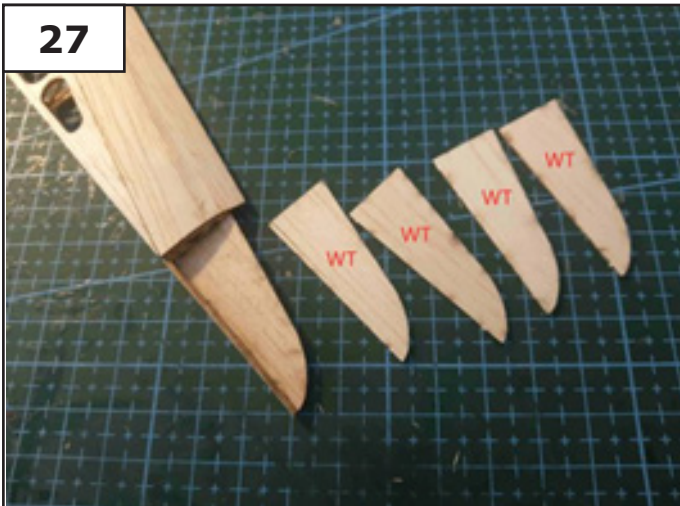
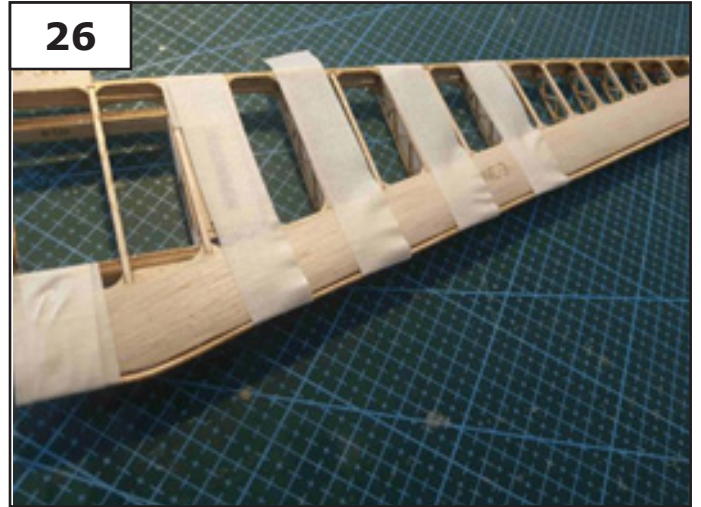
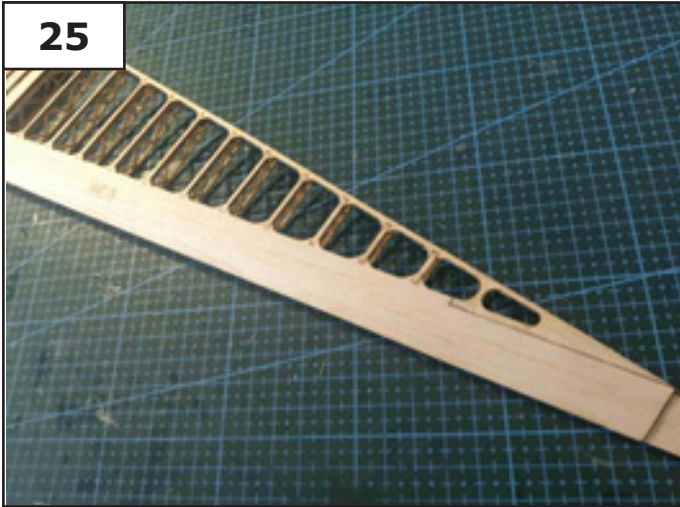

5. Tragflächen-Außen

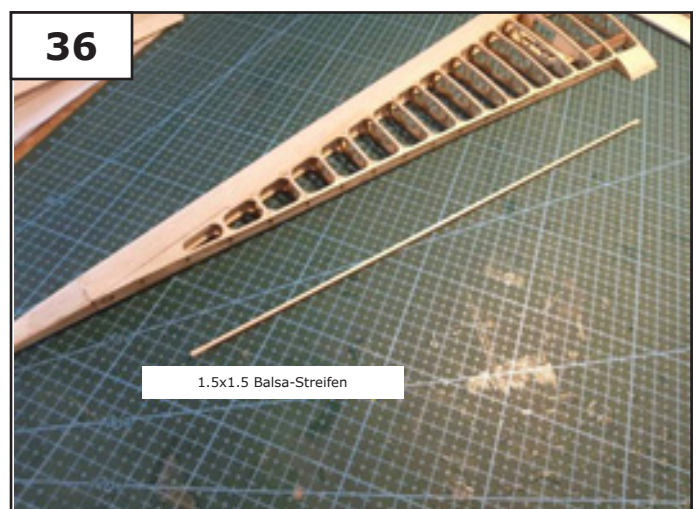
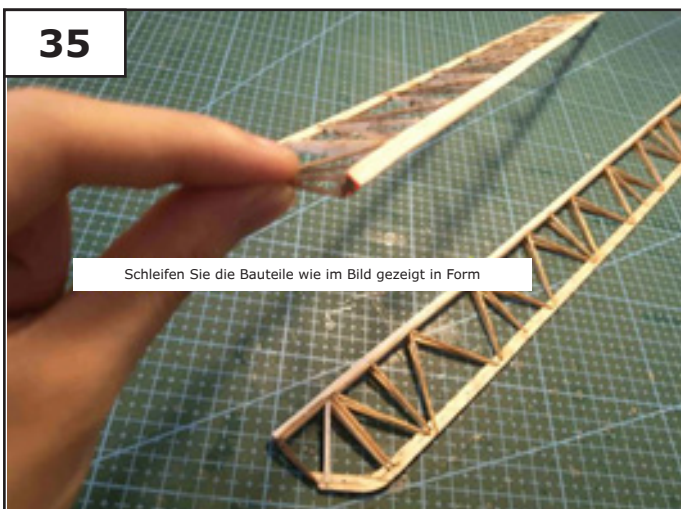
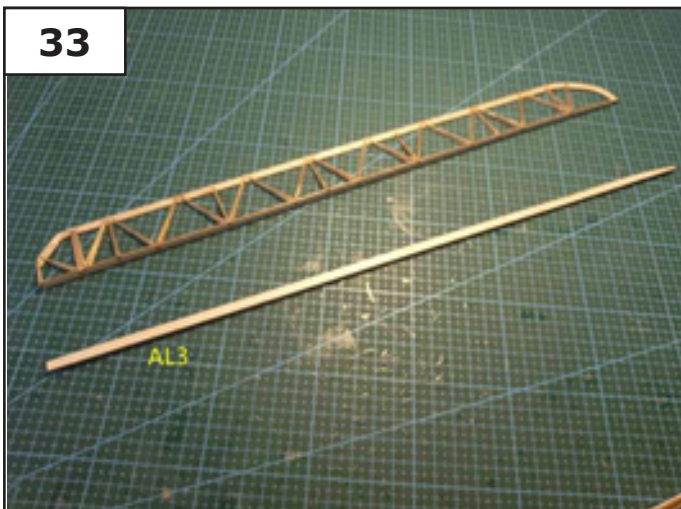
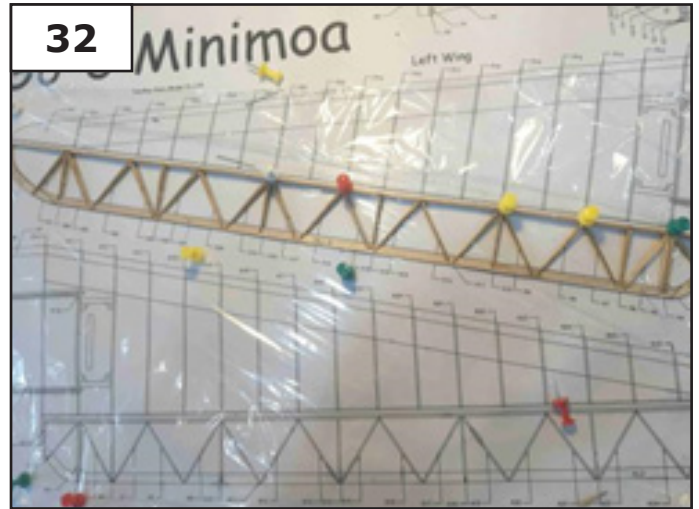
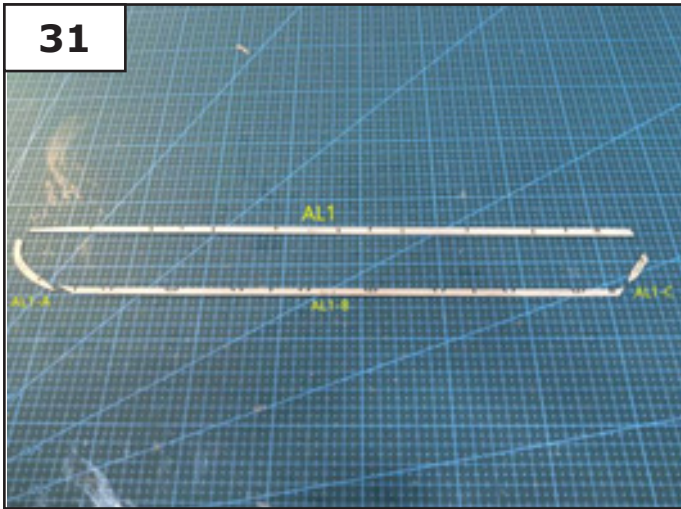

5. Tragflächen-Außen

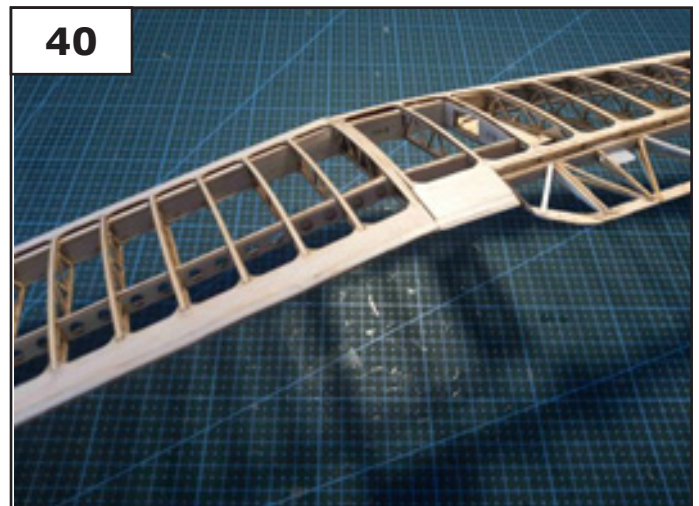
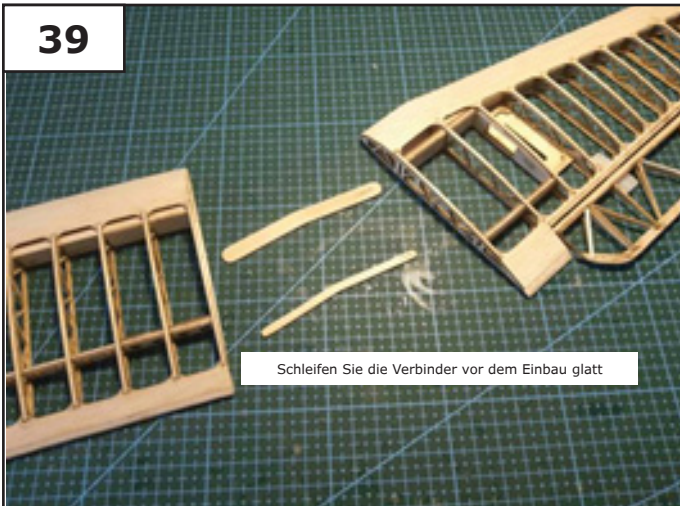
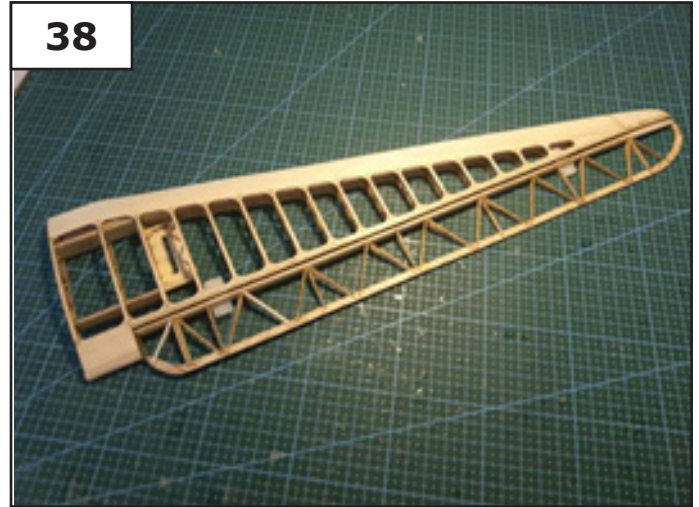
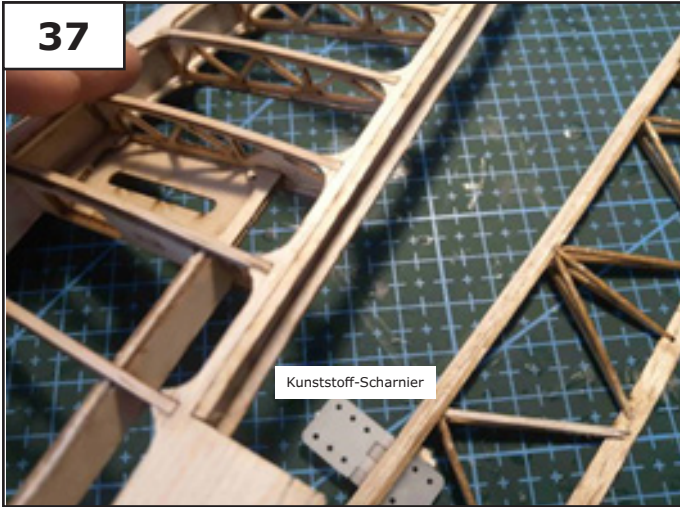

6. Zubehör-Einbau

Achtung: Bevor Sie die Tragflächen bespannen, sollten Sie vorab die Servos verbauen!

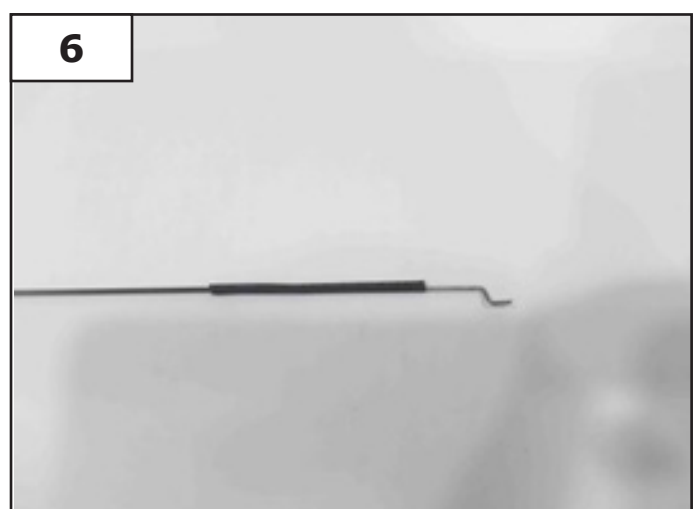
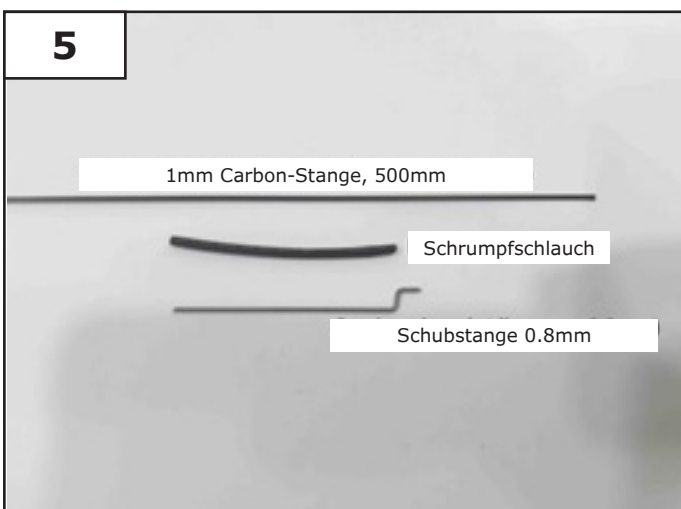
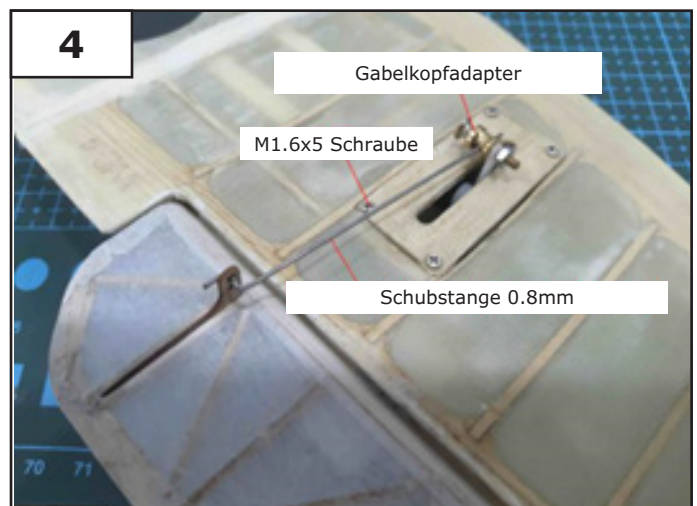
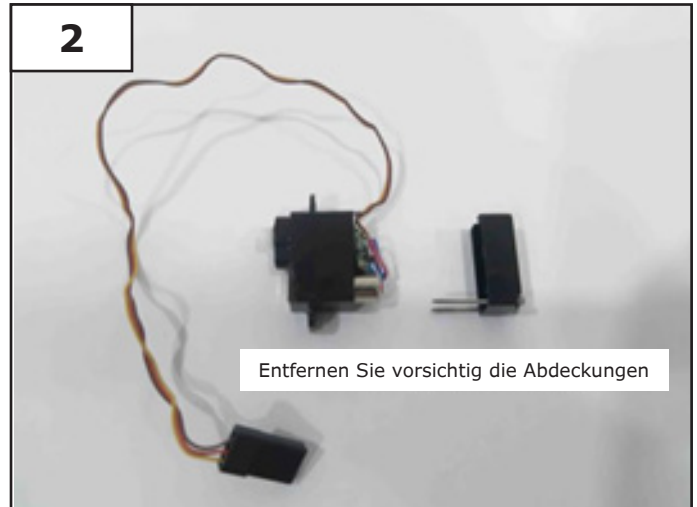
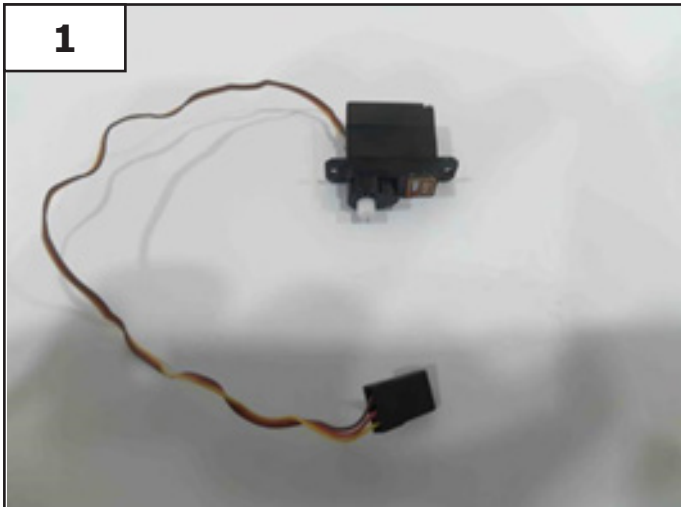

6. Zubehör-Einbau

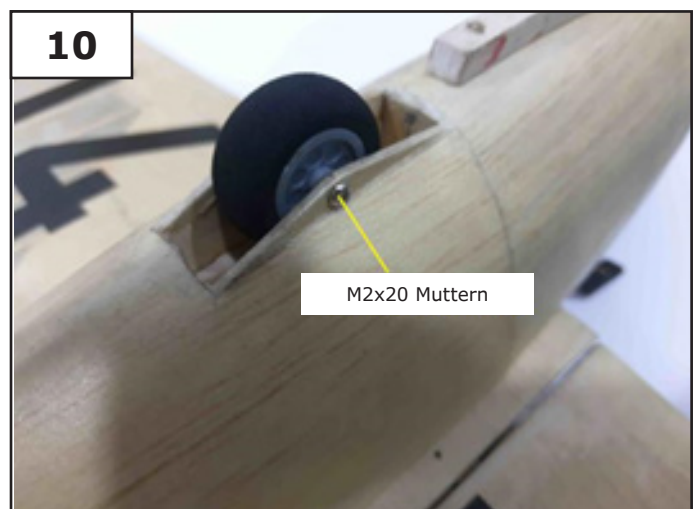
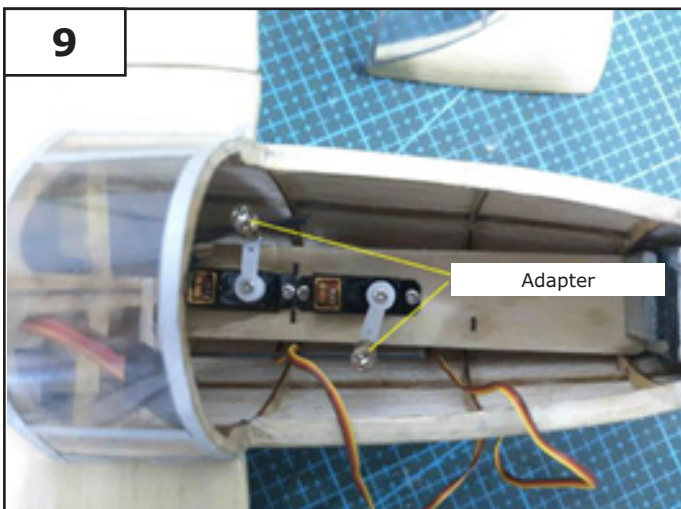
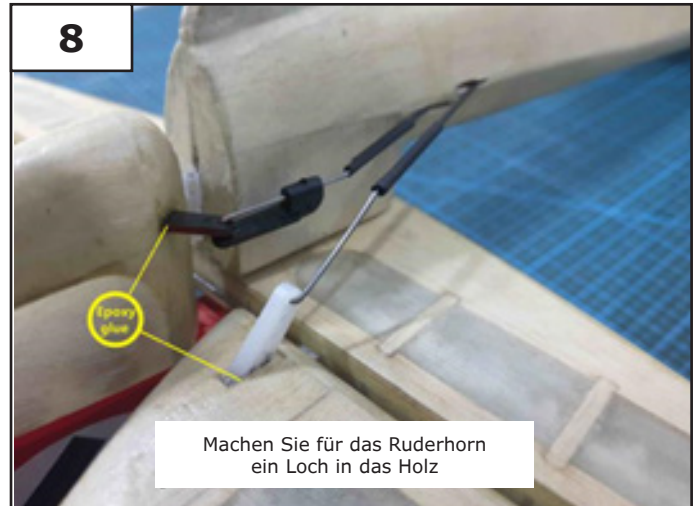
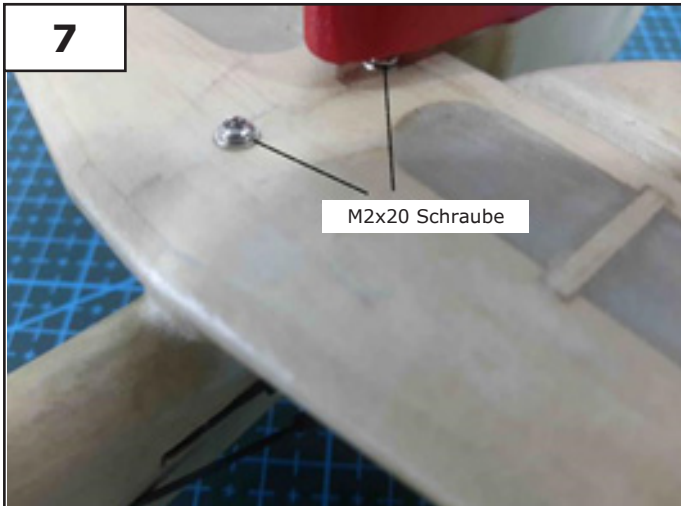

Den Rohbau des Modells haben Sie nun fertiggestellt.
Für die Bespannung empfehlen wir JAPAN Air Bespannpapier aus unserem Shop.

www.pichler.de

Auf der Artikelseite finden Sie ebenfalls eine Anleitung wie Sie das Modell optimal bespannen können.

PICHLER

Pichler MODELLBAU GmbH
Lauterbachstr. 19 | 84307 | Eggenfelden
08721/508266-0 | mail@pichler.de

Bei fehlenden Teilen verweisen Sie bitte auf folgende Abbildungen:

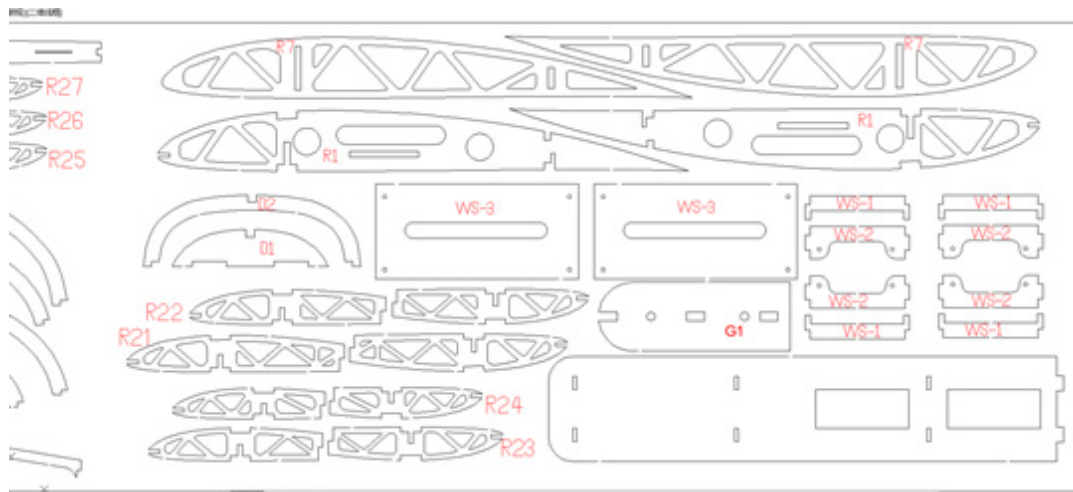
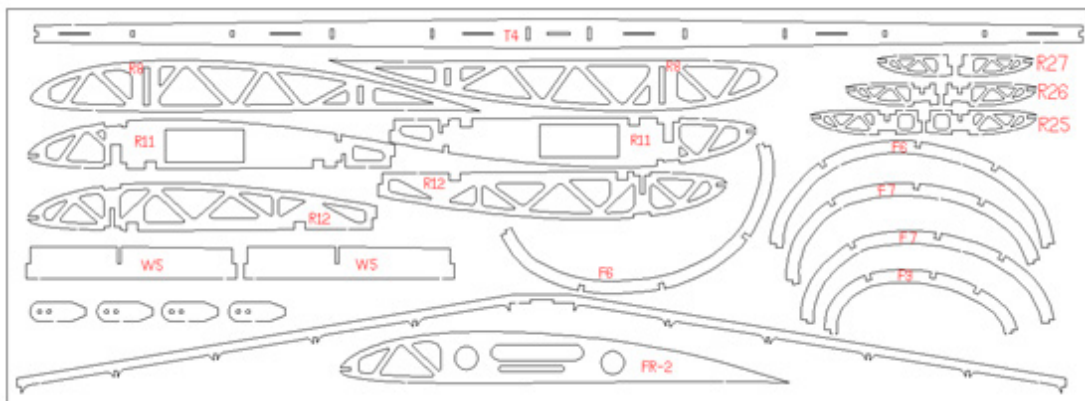
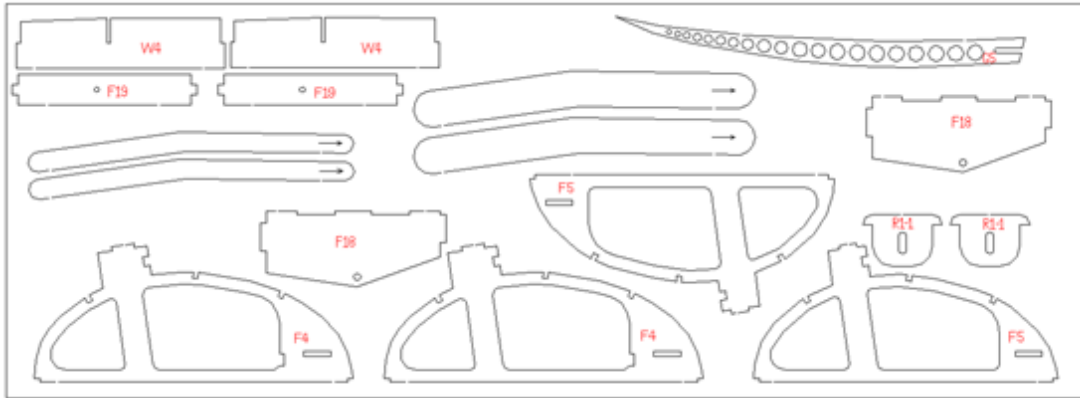

PICHLER

Pichler MODELLBAU GmbH
Lauterbachstr. 19 | 84307 | Eggenfelden
08721/508266-0 | mail@pichler.de