



Embraer EMB-312  
**TUCANO T-27**  
Brazilian Air Force 85" span 30-38cc

Code : SEA 377

## ASSEMBLY MANUAL

“Graphics and specifications may change without notice”.



### Specifications:

Wingspan----- 85.0 in----- 215.0 cm.  
Wing area----- 1097.4 sq.ins----- 70.8 sq.dm.  
Weight----- 17.9 lbs----- 8.1 kg.  
Length----- 69.4 in----- 176.4 cm.  
Engine/Motor size----- 30-38cc gasoline.  
Radio----- 9 channels with 10 servos.

## INTRODUCTION

Thank you for choosing the **Embraer EMB-312 Tucano T-27 Brazilian Air Force 85" span 30-38cc** with the intermediate/advanced sport flyer in mind. It is a semi scale airplane which is easy to fly and quick to assemble. The airframe is conventionally built using balsa, plywood to make it stronger than the average ARTF, yet the design allows the aeroplane to be kept light. You will find that most of the work has been done for you already. The motor mount has been fitted and the hinges are pre-installed. Flying the **Embraer EMB-312 Tucano T-27 Brazilian Air Force 85" span 30-38cc** is simply a joy.

This instruction manual is designed to help you build a great flying aeroplane. Please read this manual thoroughly before starting assembly of your **Embraer EMB-312 Tucano T-27 Brazilian Air Force 85" span 30-38cc**. Use the parts listing below to identify all parts.

## WARNING

*Please be aware that this aeroplane is not a toy and if assembled or used incorrectly it is capable of causing injury to people or property. WHEN YOU FLY THIS AEROPLANE YOU ASSUME ALL RISK & RESPONSIBILITY.*

If you are inexperienced with basic R/C flight we strongly recommend you contact your R/C supplier and join your local R/C model Flying Club. R/C Model Flying Clubs offer a variety of training procedures designed to help the new pilot on his way to successful R/C flight. They will also be able to advise on any insurance and safety regulations that may apply.

## KIT CONTENTS



## KIT CONTENTS

### SEA377 Embraer EMB-312 Tucano T-27 Brazilian Air Force 85” span 30-38cc

1. Fuselage
2. Wing set (2)
3. Tail set (2)
4. Cockpit, Pilot and canopy (2)
5. Cowling
6. Wing tube
7. Fuel tank
8. Wheels
9. Pushrod set
10. Ep Motor box
11. Spinner

## ADDITIONAL ITEMS REQUIRED

- 30-38cc gasoline engine.
- Computer radio 9 channel with 10 servos.
- Glow plug to suit engine.
- Propeller to suit engine.
- Protective foam rubber for radio system.

## TOOLS & SUPPLIES NEEDED

- Thin cyanoacrylate glue.
- Medium cyanoacrylate glue.
- 30 minute epoxy.
- 5 minute epoxy.
- Hand or electric drill.
- Assorted drill bits.
- Modelling knife.
- Straight edge ruler.
- 2mm ball driver.
- Phillips head screwdriver.
- 220 grit sandpaper.
- 90° square or builder's triangle.
- Wire cutters.
- Masking tape & T-pins.
- Thread-lock.
- Paper towels.

## WING TIP BULBS

Please see below pictures.

1.



2.

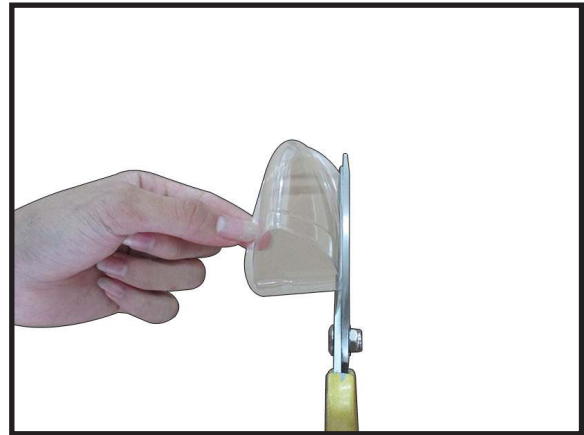

3.



Two white lights for cowling and rudder, the green light for right wing tip, and the red light for left wing tip. They are designed to operate on voltages 12 volts. Connect four lights into switch circuit so that optional the different flashes mode.

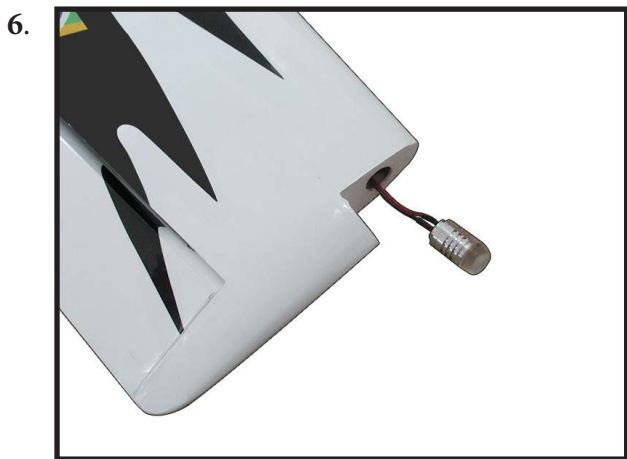

**INSTALL THE AILERONS**

Please see below pictures.

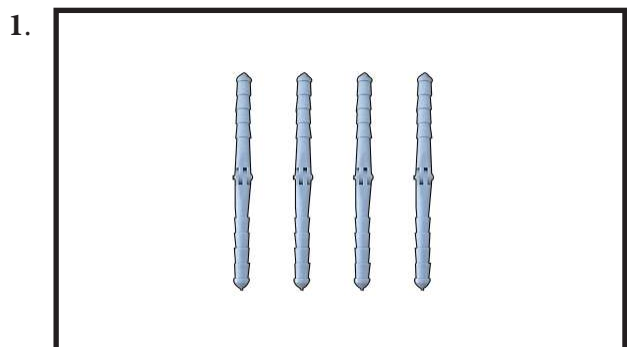



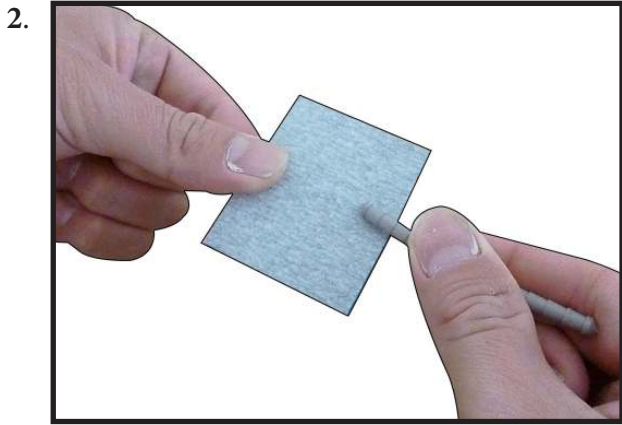

Remove the ailerons from the wing and remove the hinges.

Use a small piece of rough sandpaper to scuff the hinges for better epoxy adhesion. Do this to all aileron hinges.

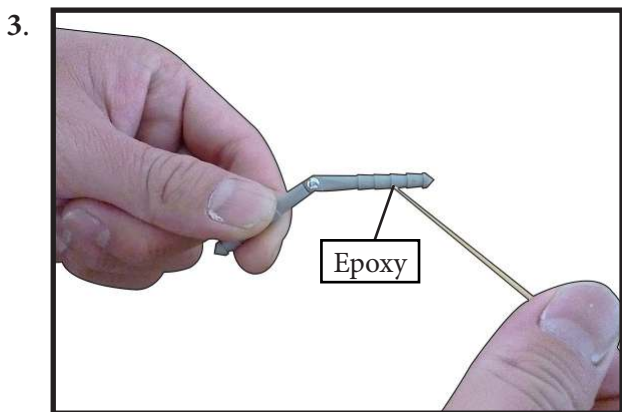

Apply epoxy to each hinge where it will be inserted into the ailerons. Tip: Apply some petroleum jelly to the metal pin hinge area to keep epoxy from interfering with smooth operation of hinge.

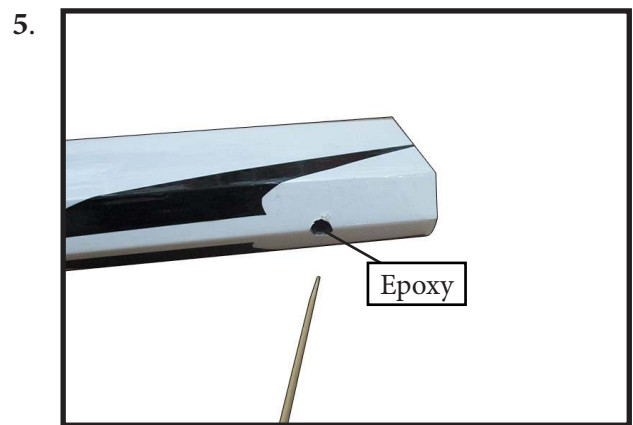
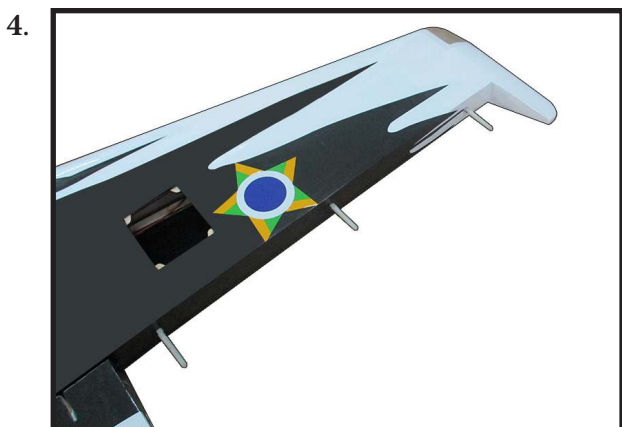

Apply epoxy into each of the holes in the ailerons using a spare piece of pushrod wire or toothpick.

Make sure to use enough epoxy so it securely adheres the hinge to the surfaces.

Do not use an excessive amount of epoxy when gluing the hinges so that it expels from the hinge area.

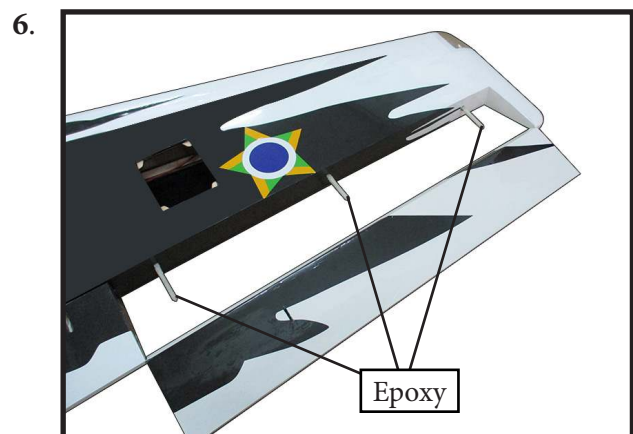

Be sure to test the aileron hinges once you insert them. Ensure that the hinge pockets line up, and that the hinges move freely before the epoxy dries.

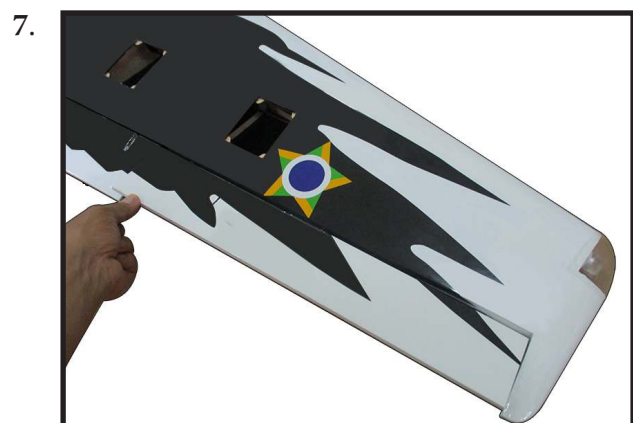

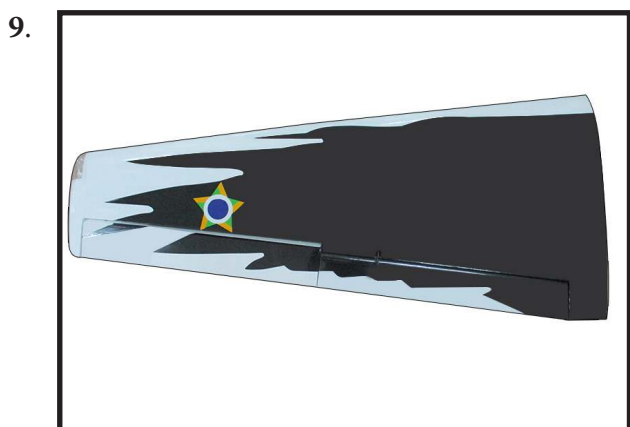
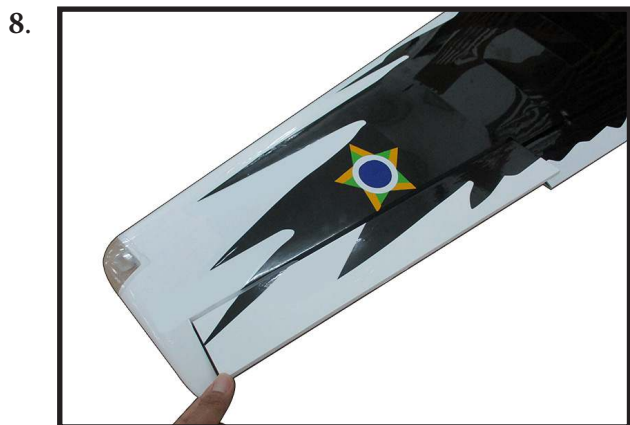

Check the fit of the aileron to the wing. The top of the ailerons will align to the top of the wing. Make sure movement is smooth and bind free.

We prefer 30-minute epoxy to allow enough working time during the hinge installation.

**INSTALL THE AILERONS CONTROL HORN**

Locate the aileron and flap control horns. The taller control horn is used for the ailerons, and the shorter horn for the flaps.

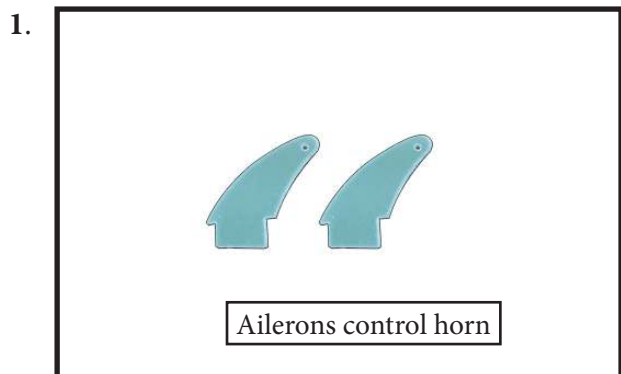

Use sandpaper to scuff the bottom of the aileron and flap control horns. Use a paper towel and isopropyl alcohol to remove any oils or debris from the control horns.

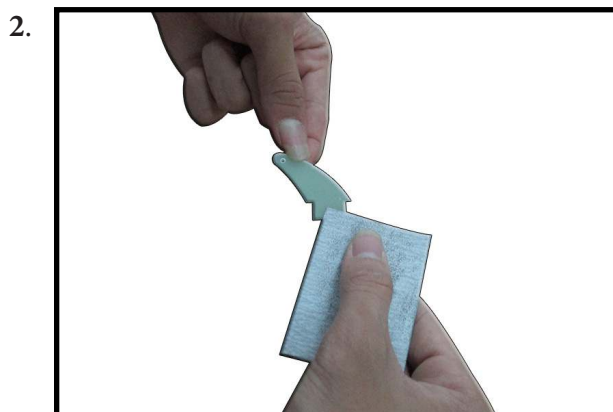

Check the fit of the control horns to the aileron and flap. They should rest flush against the control surface as shown.



Place low-tack tape 1/32 inch (1mm) from the control horn slot. This will prevent epoxy from getting on the control surface when the control horns are glued in place.

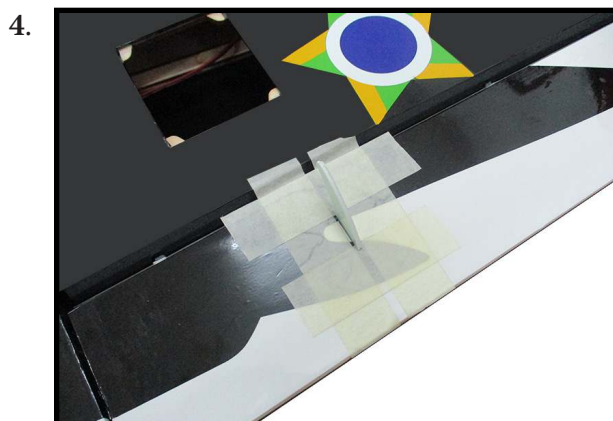

Remove the control horns from the control surfaces. Apply epoxy to the slot in the aileron and flap. Make sure the epoxy gets into the slot for a good bond between the surfaces and control horn.

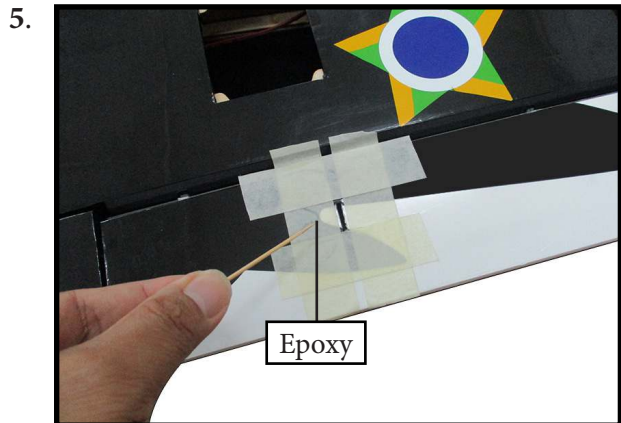

Apply epoxy to the area of the control horns that fist into the slots. Use enough epoxy so the control horns will be fully bonded to the fied surfaces.

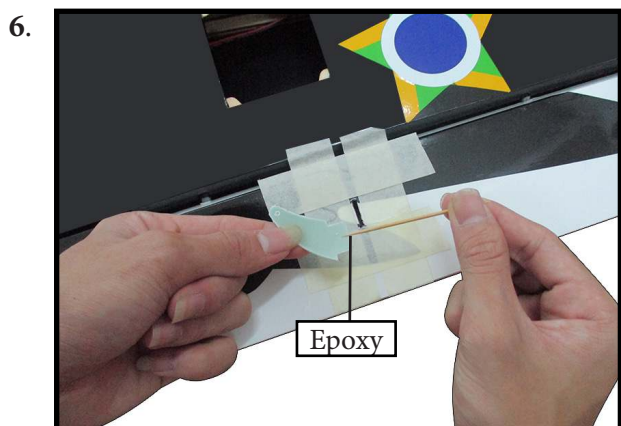

Before the epoxy fully cures, remove the tape from around the control horn. This will allow the epoxy to flow around the control horn, creating a small fillet between the control horn and surface for a fiished look and secure bond.



### INSTALLING THE AILERON SERVOS

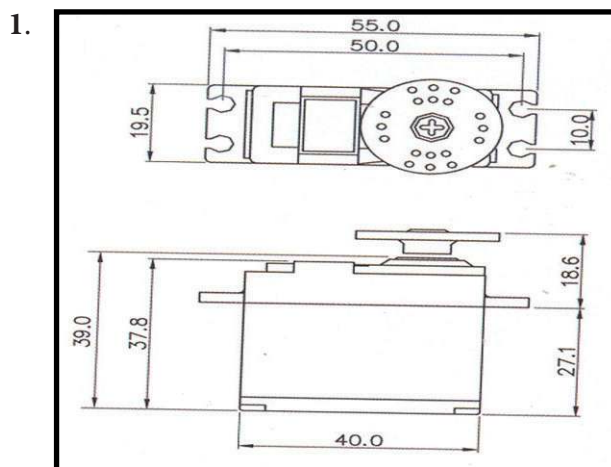

**Mininum servo spec.**  
**Torque :** 110 oz-in (7.9 kg-cm) @ 4.8V;  
 131 oz-in (9.4 kg-cm) @ 6.0V

 Because the size of servos differ, you may need to adjust the size of the precut opening in the mount. The notch in the sides of the mount allow the servo lead to pass through.

Place the servo between the mounting blocks and space it from the hatch. Use a pencil to mark the mounting hole locations on the blocks.

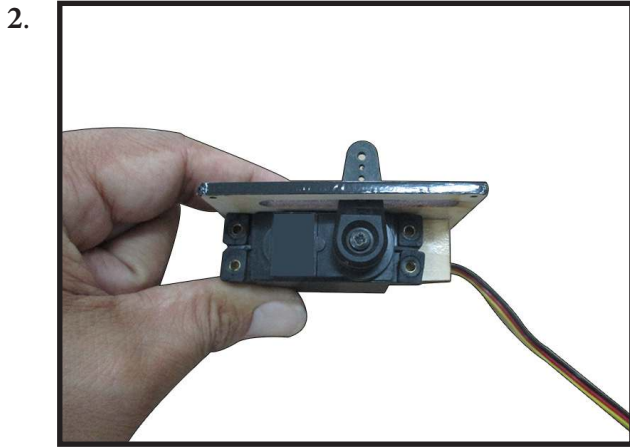

Use drill bit in a pin vise to drill the mounting holes in the blocks.

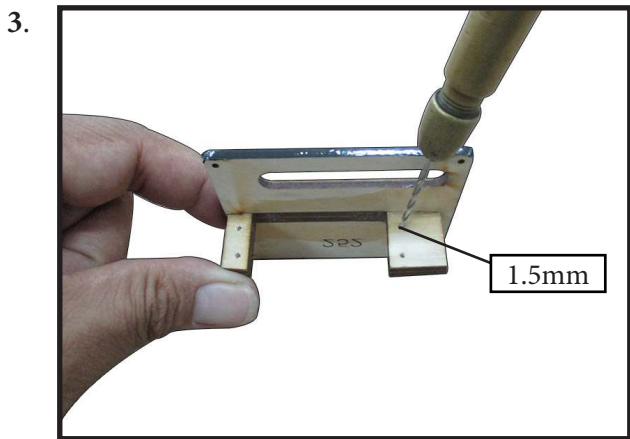

Apply 2-3 drops of thin C/A to each of the mounting holes. Allow the C/A to cure without using accelerator.

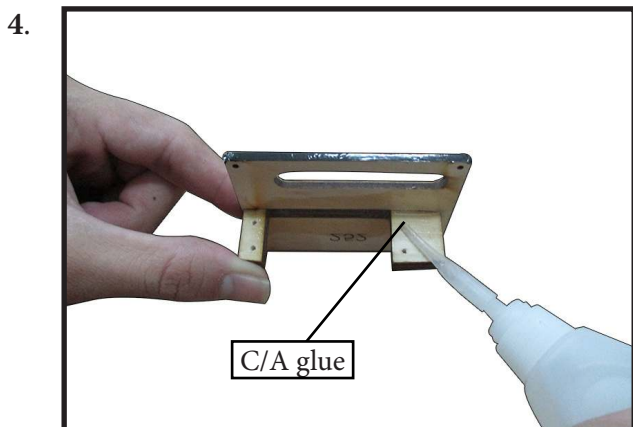

Use dental floss or heatshrink tube to secure the connection so they cannot become unplugged.

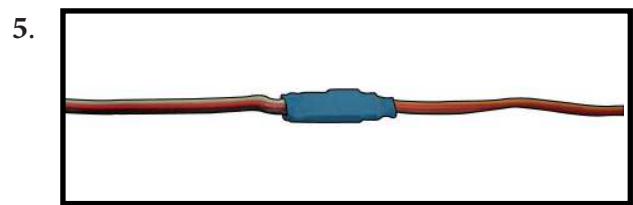

Secure the servo to the aileron hatch using Phillips screwdriver and the screws provided with the servo.

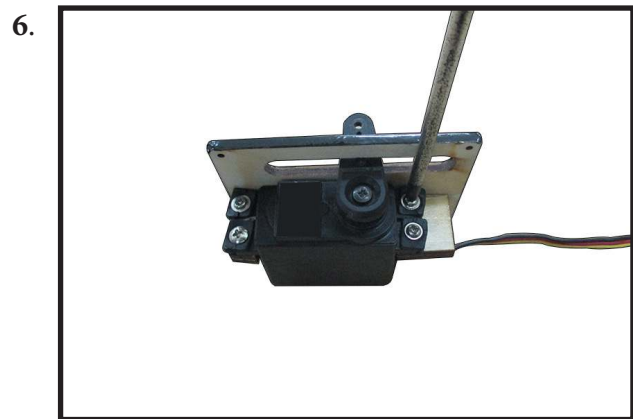

Apply 1-2 drops of thin C/A to each of the mounting tabs. Allow the C/A to cure without using accelerator.

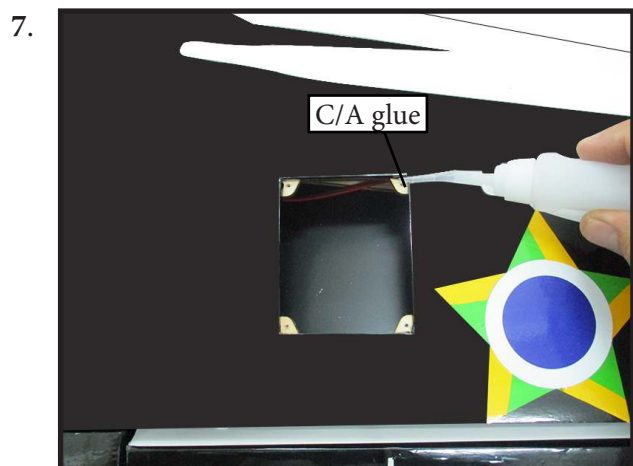

Remove the string from the wing at the servo location and use the tape to attach it to the servo extension lead. Pull the lead through the wing and remove the string.



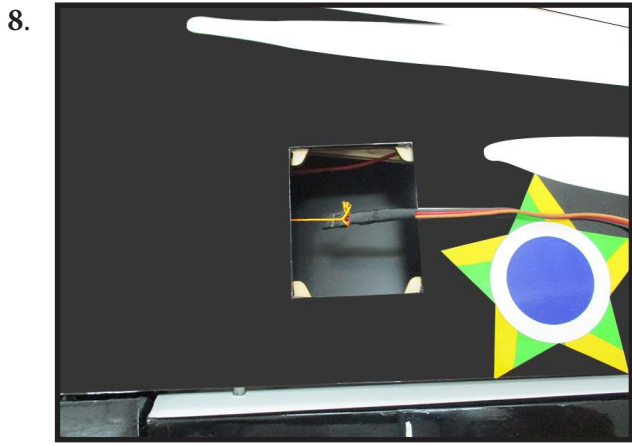

Set the aileron hatch in place and use a Phillips screw driver to install it with four wood screws.

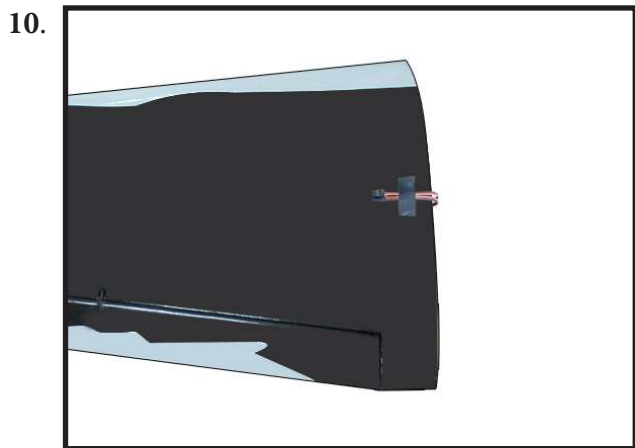
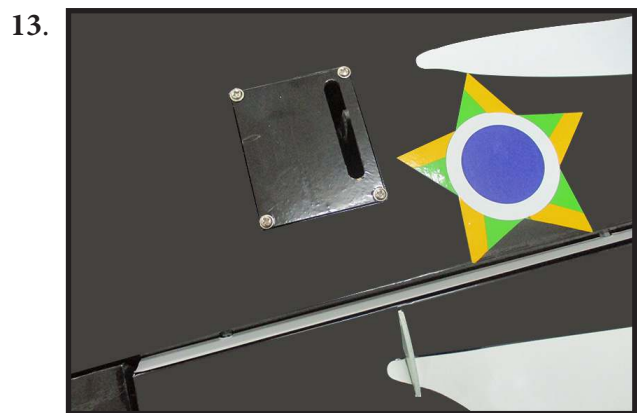
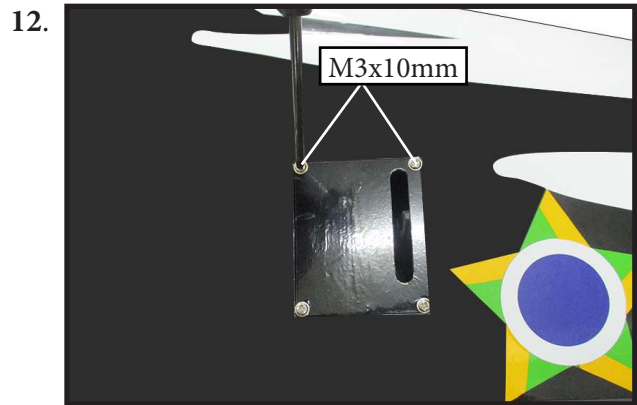
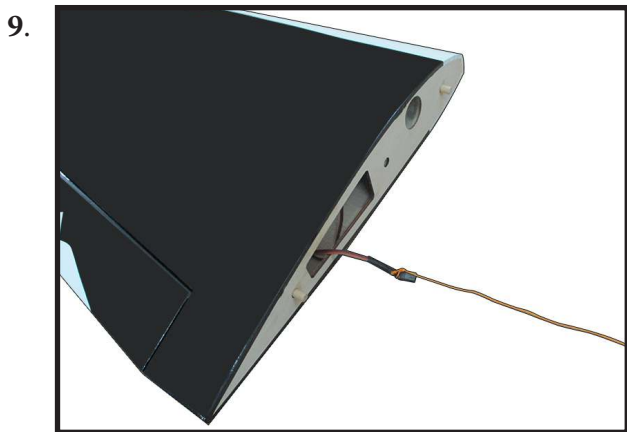

**AILERON PUSHROD INSTALLATION**

Please see below pictures.

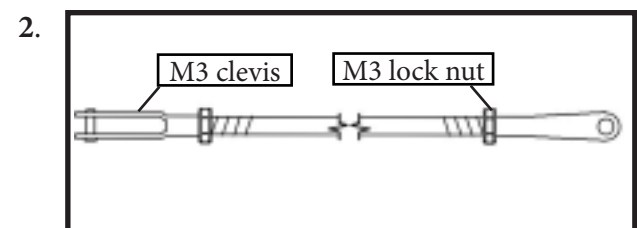
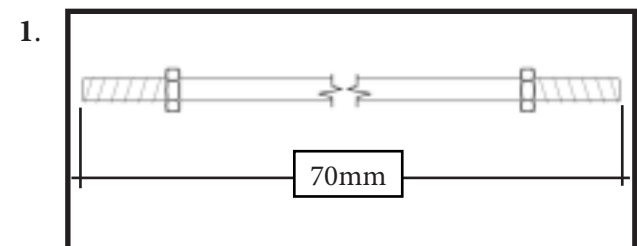



### INSTALLING THE FLAP PUSHROD

Please see below pictures.

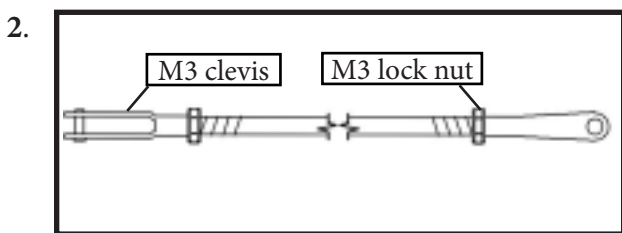
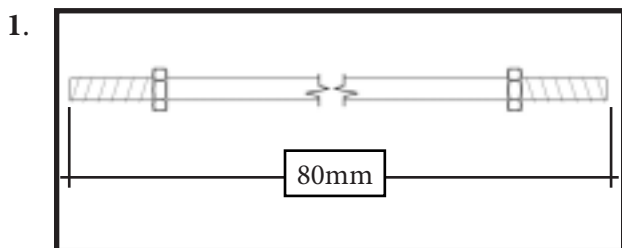

Attach the flap servo to the flap servo cover. Center the flap servo (or set the values to 0 for both up and down) and install the servo arm perpendicular to the servo centerline. The clevis will attach to the arm 13/16 inches (21mm) from the center of the arm.

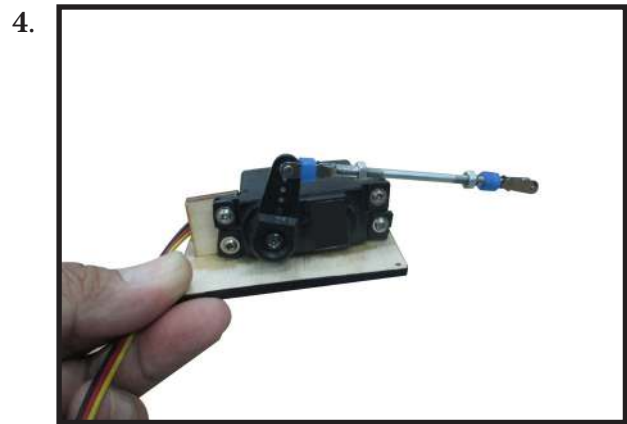
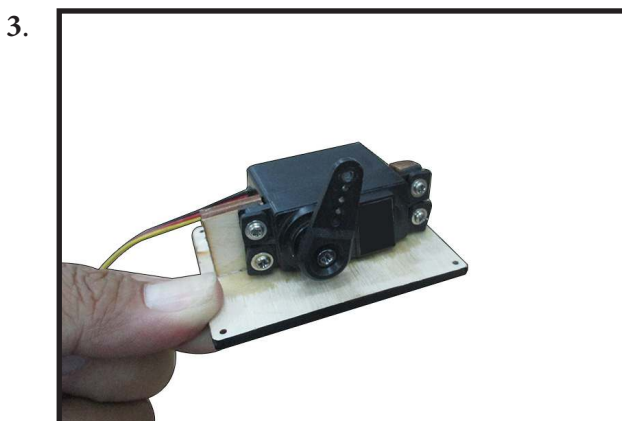

Attach the flap linkage to the control horn. Slide the clevis retainer over the forks of the clevis.



Attach the clevis to the flap servo arm.

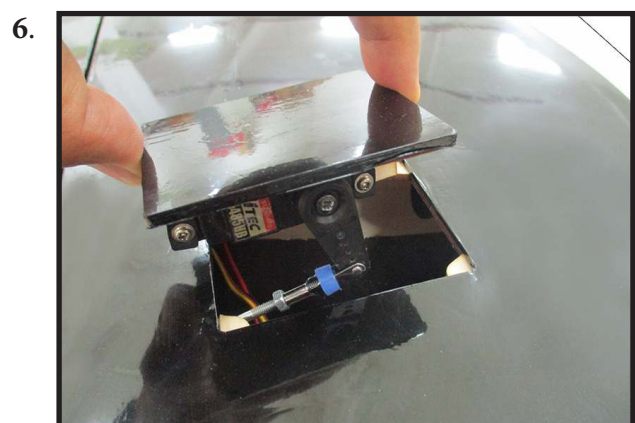

Use a pin vise and 3/32-inch (2mm) drill bit to clear the paint from the flap control horn.

7.

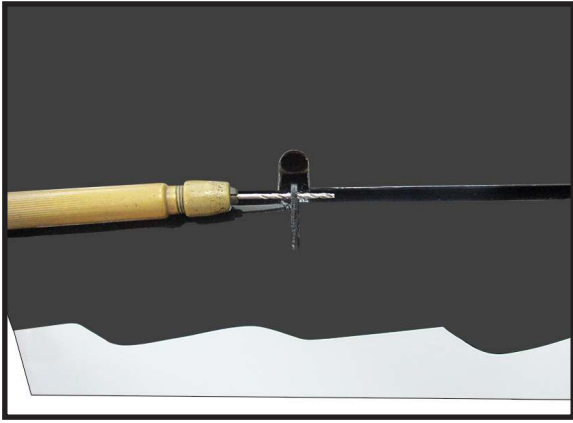

Route the servo lead for the flap servo out at the root of the wing. Connect the flap servo to the radio system. With the radio system on, place the flap servo into position.

8.



Adjust the linkage so the flap is in the mid-flap position. It may take a few tries to properly adjust the linkage.

9.

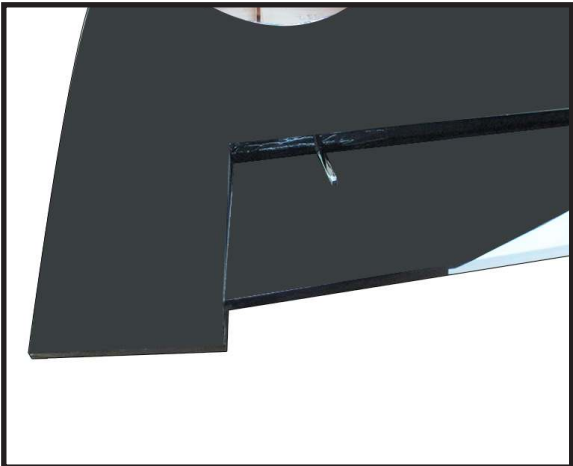

Once adjusted, make sure all clevis retainers are in position. Apply a drop of threadlock near the clevis, then tighten the nut against the clevis to keep the linkage from changing length inside the wing.

10.

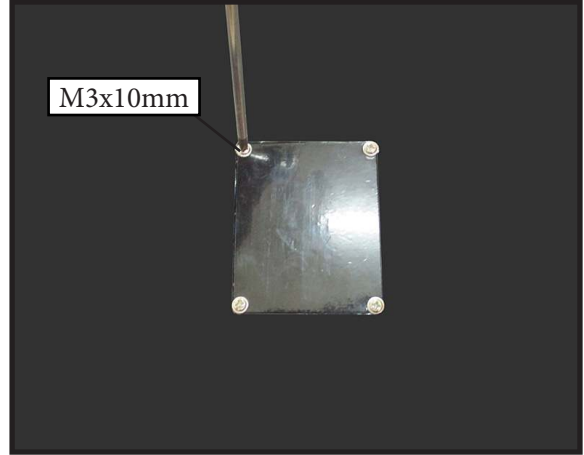

11.

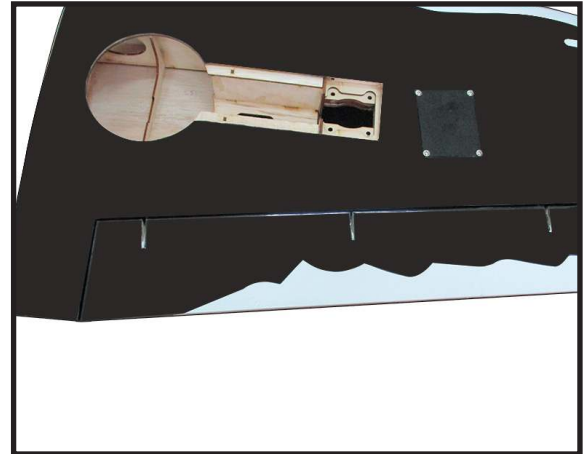

Set the flap control at the transmitter to the down flap position. Adjust the flap travel at the transmitter until it matches the control throws listed in this manual.

12.



Trim the flap linkage cover using a hobby knife and hobby scissors.

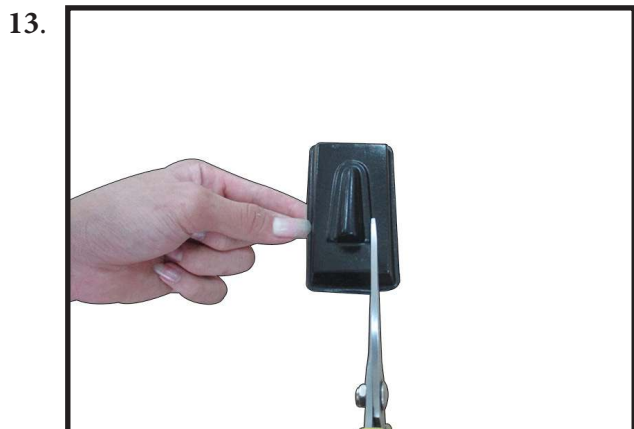

Fit the flap linkage cover into position. Check the operation of the flap to make sure the cover does not interfere with the flap linkage.



Use canopy glue to attach the cover to the wing. Use low-tack tape to keep the cover in position until the adhesive fully cures.

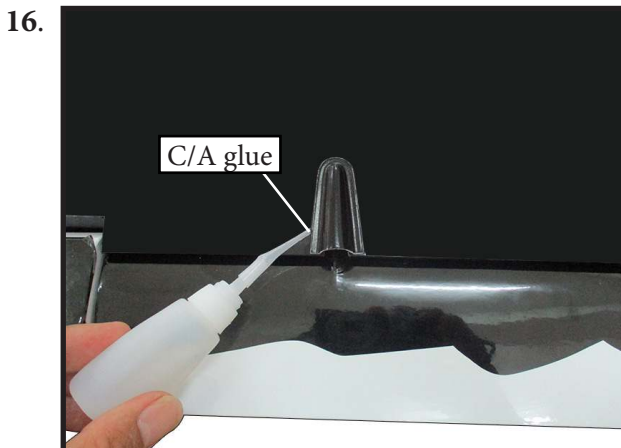

**INSTALLING LANDING GEAR**

Locate items necessary to install Sprin Landing Gear.

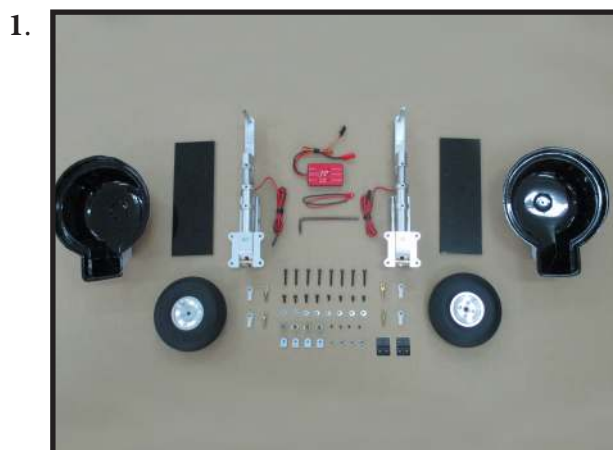

Install retractable landing gear at the Wing.





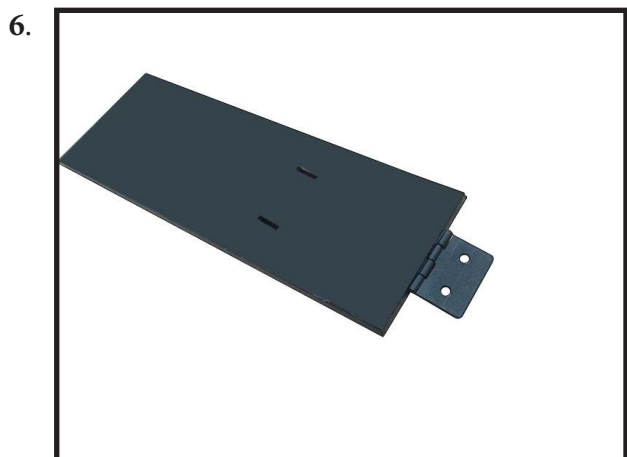
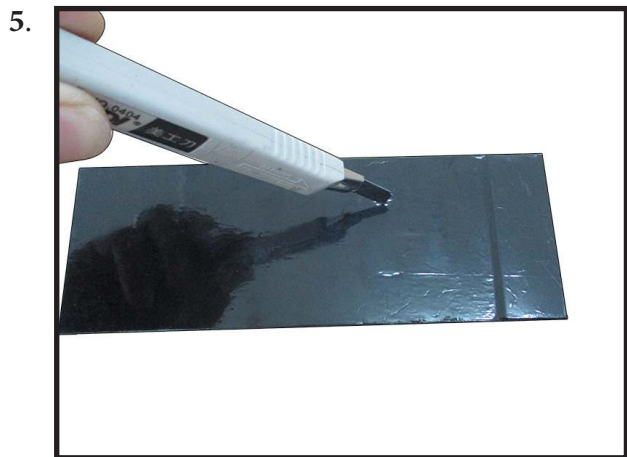
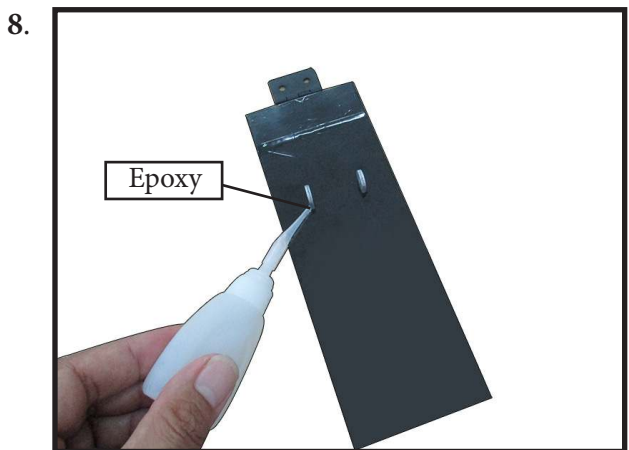
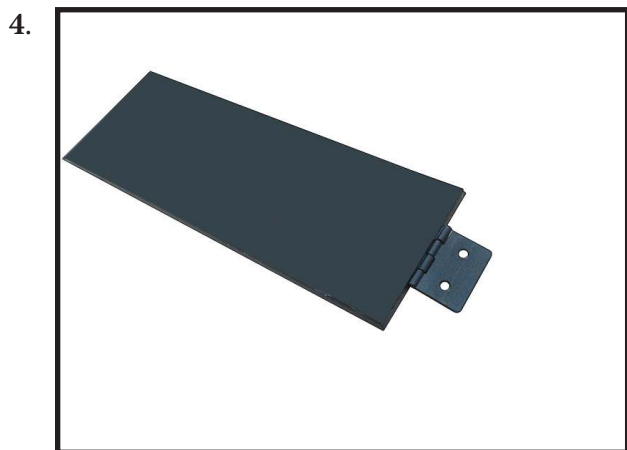
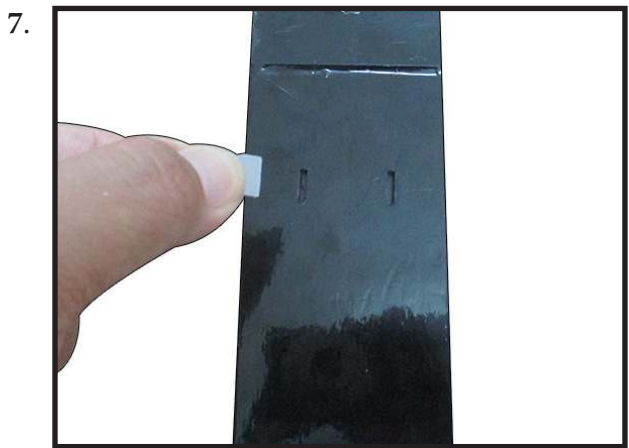
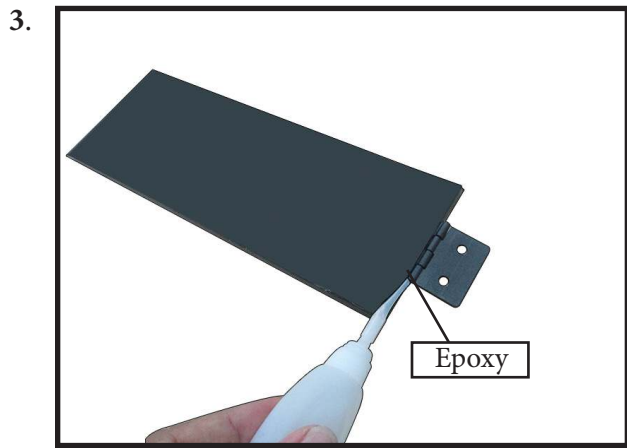

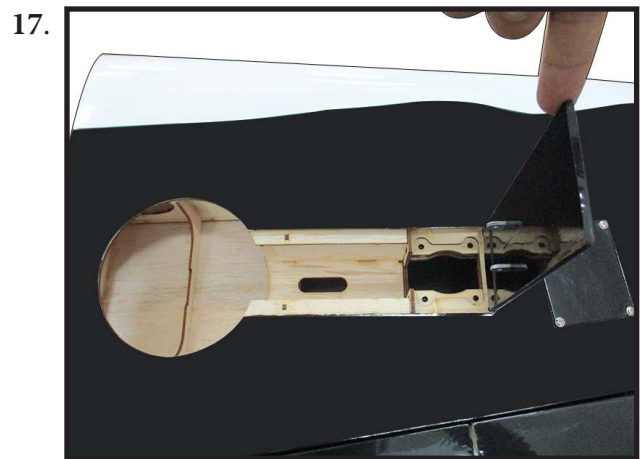
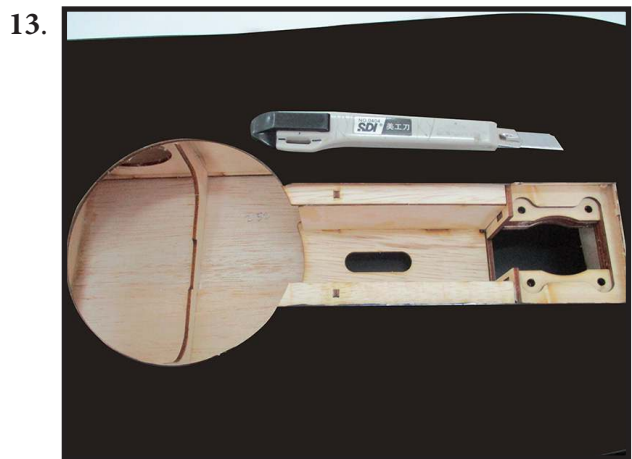
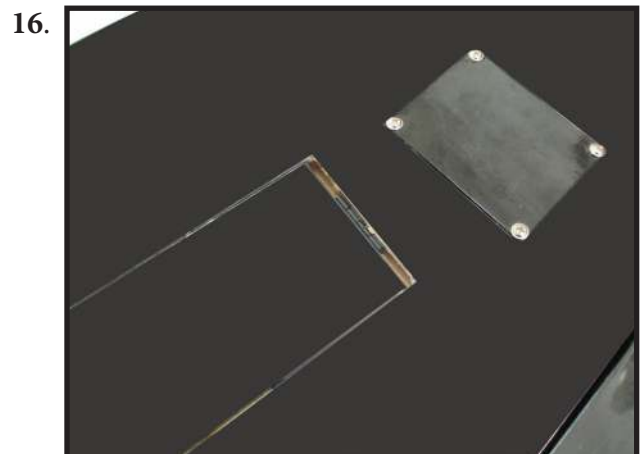
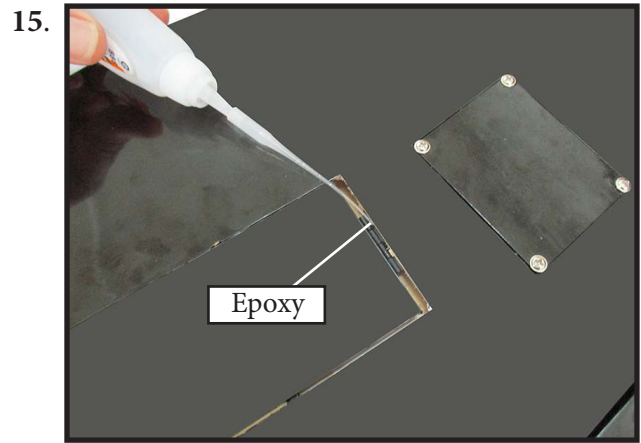

19.

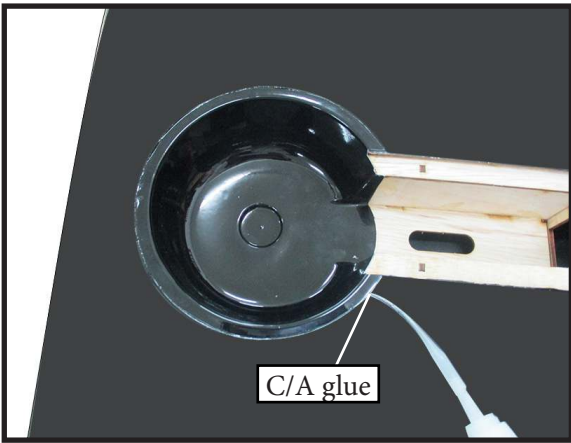

23.

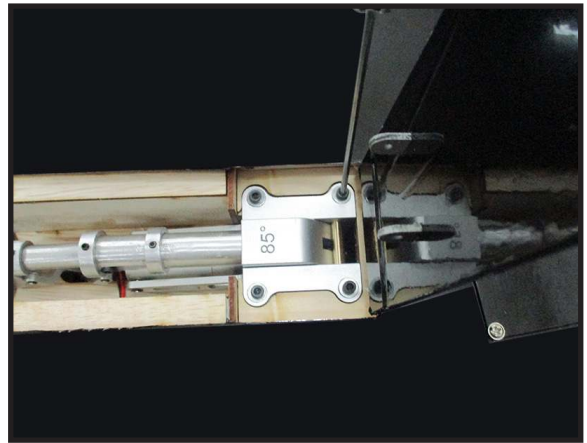

20.

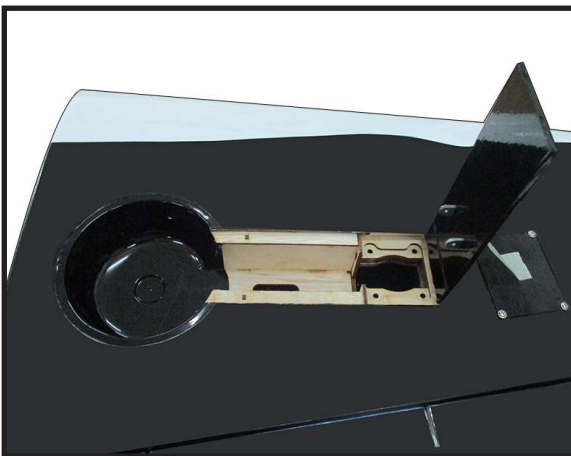

24.

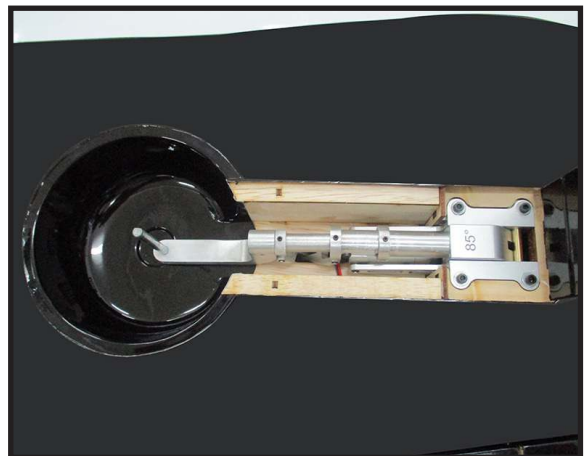

21.



25.

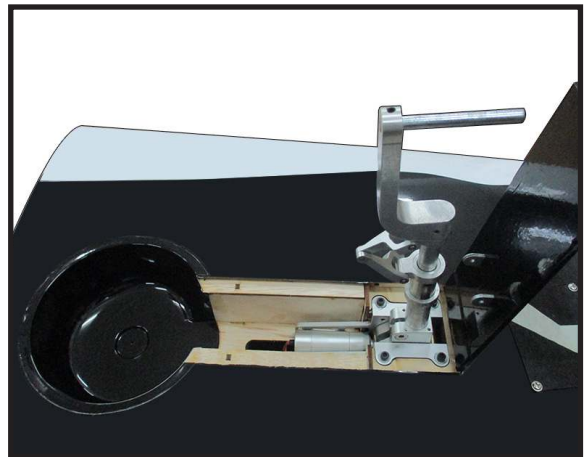

22.

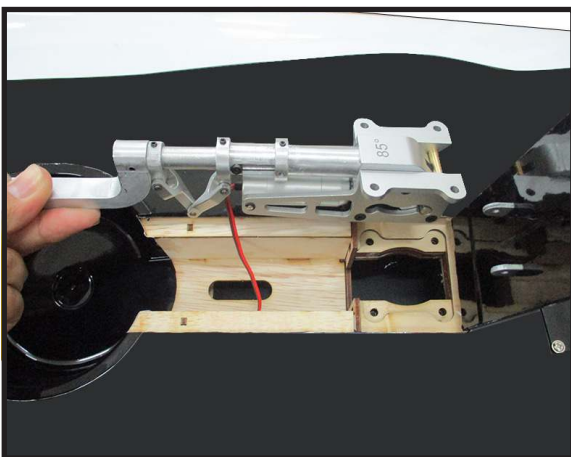

26.

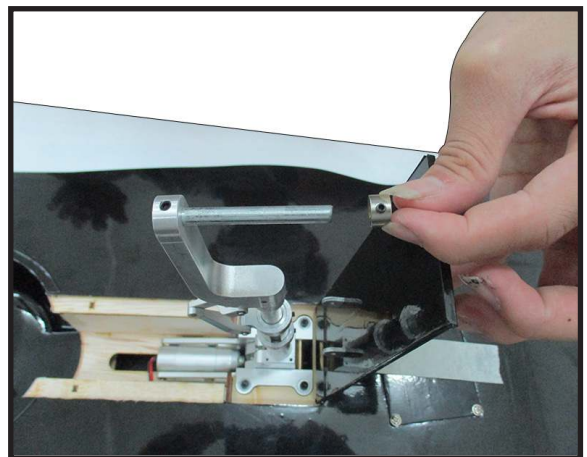



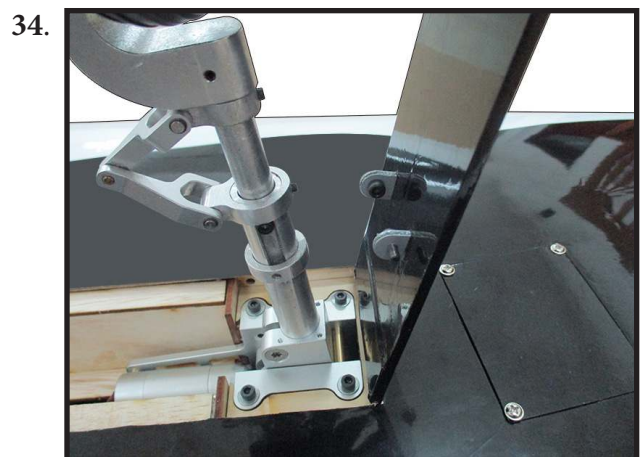
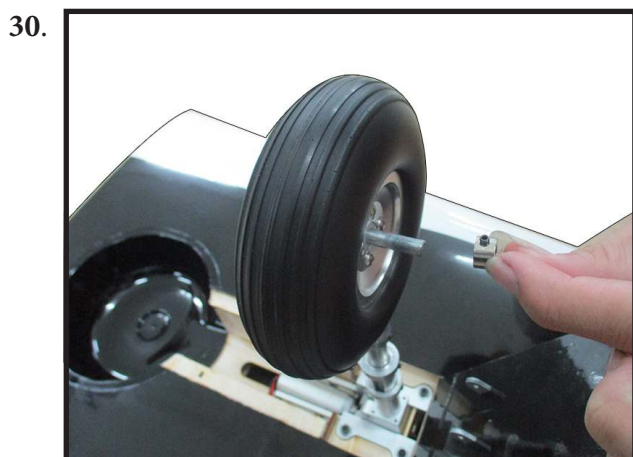
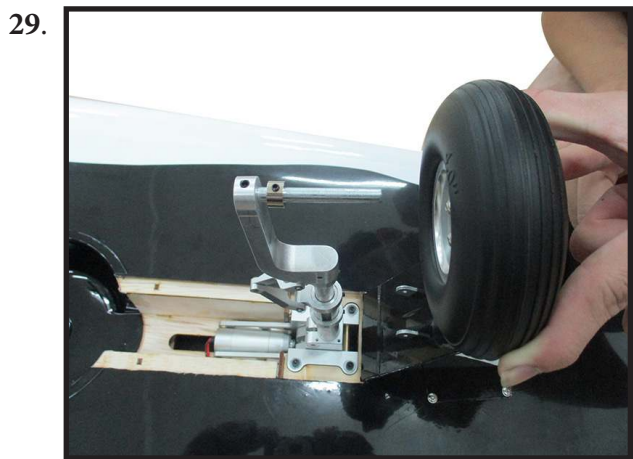
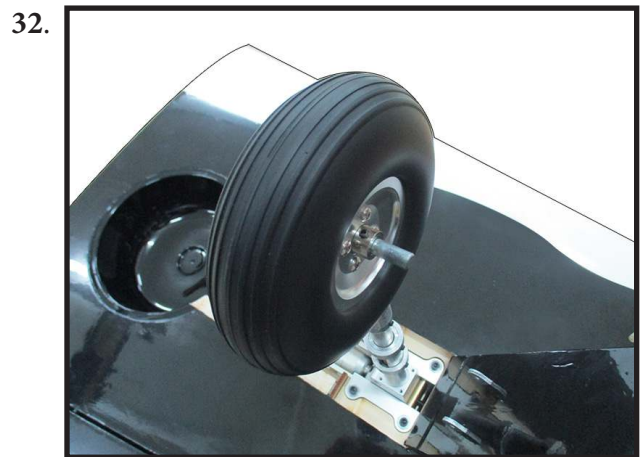
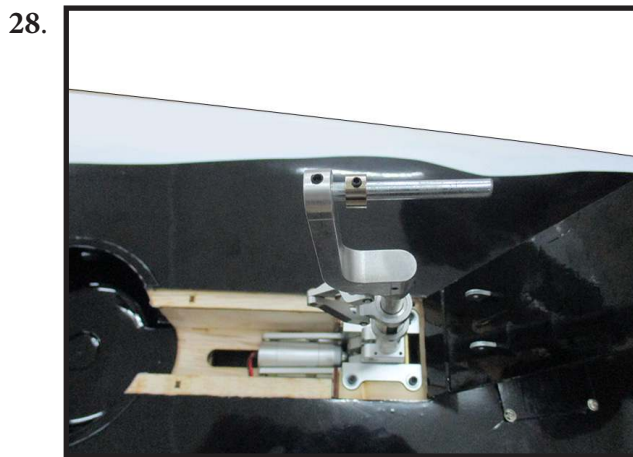
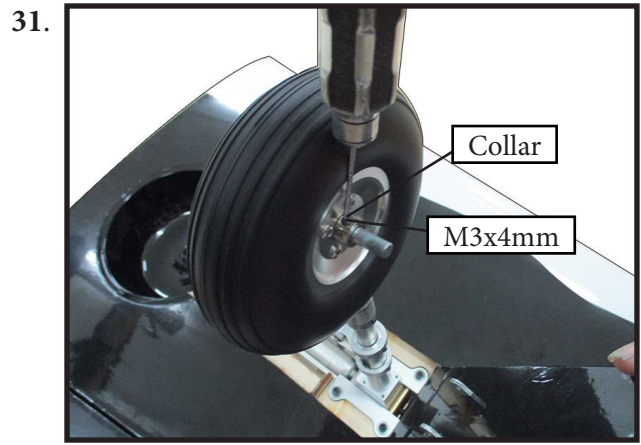
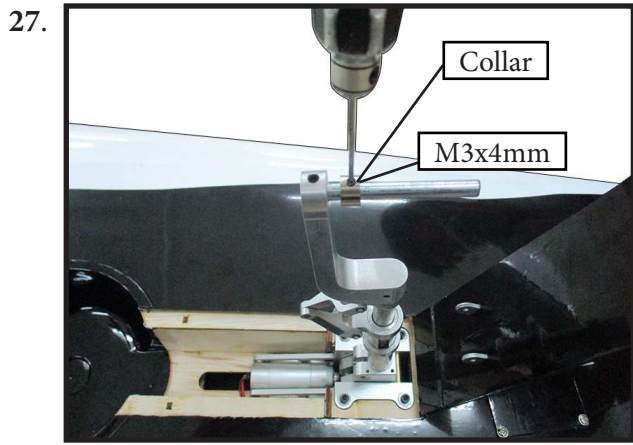



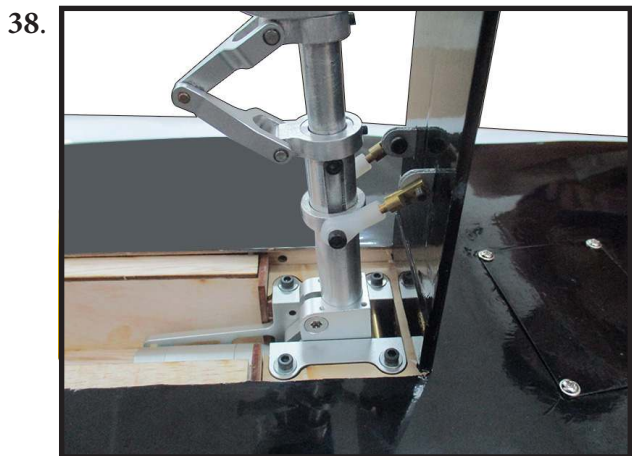
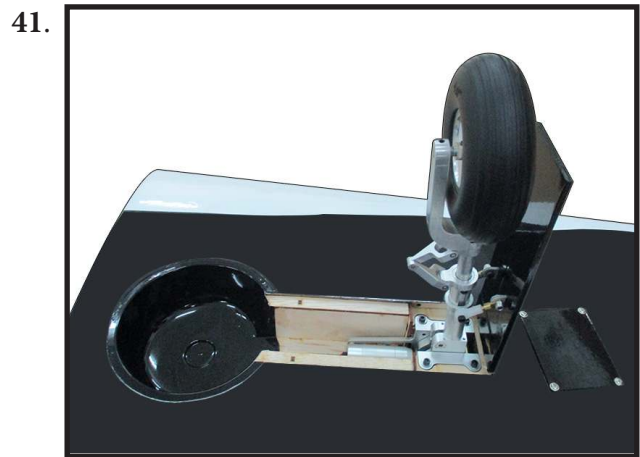
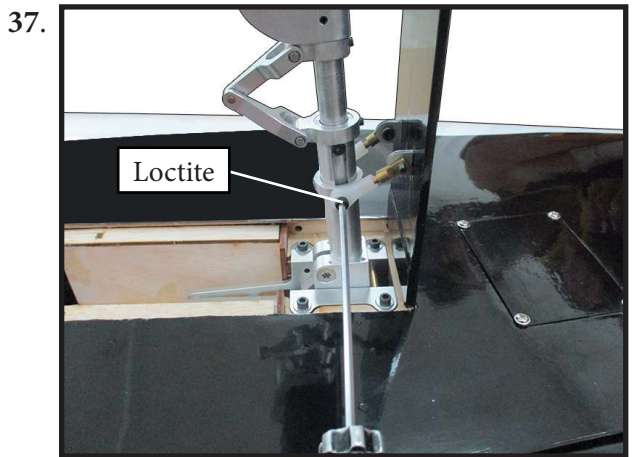
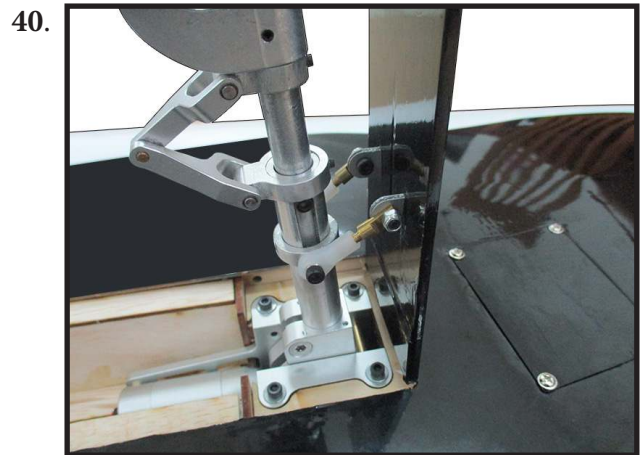
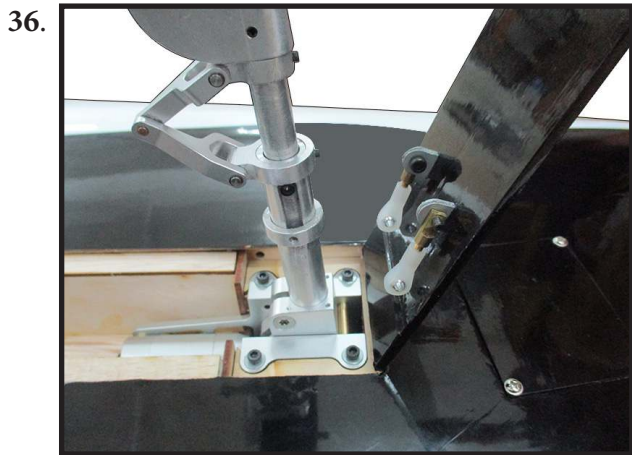
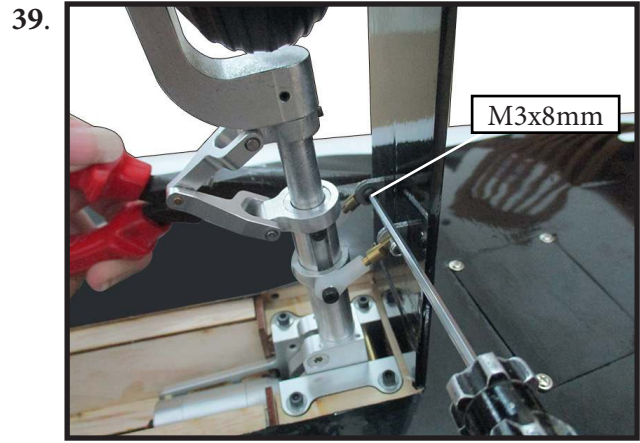
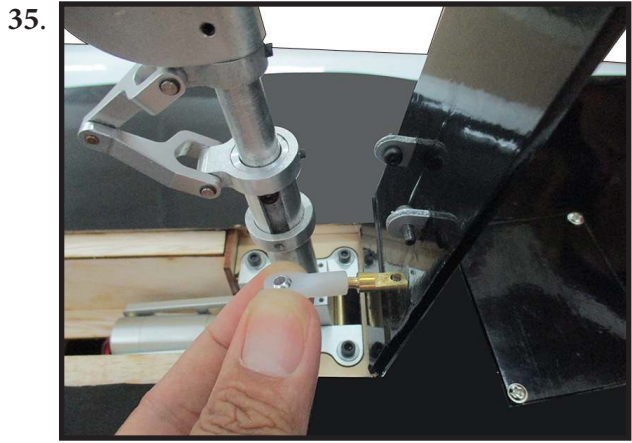

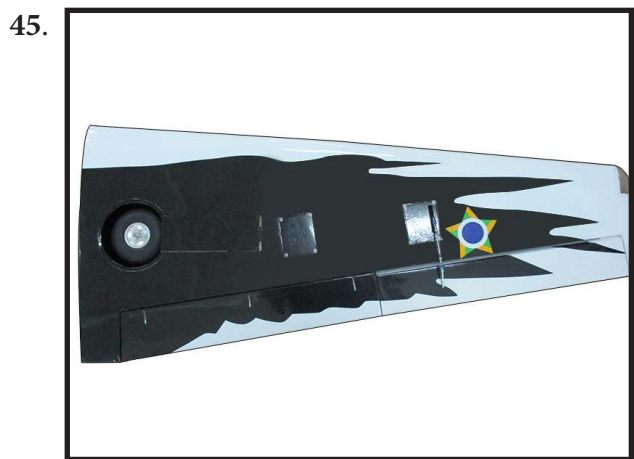



**INSTALLING THE FUSEKAGE SERVOS**

 Because the size of servos differ, you may need to adjust the size of the precut opening in the mount. The notch in the sides of the mount allow the servo lead to pass through.

Secure the servos with the screws provided with your radio system.

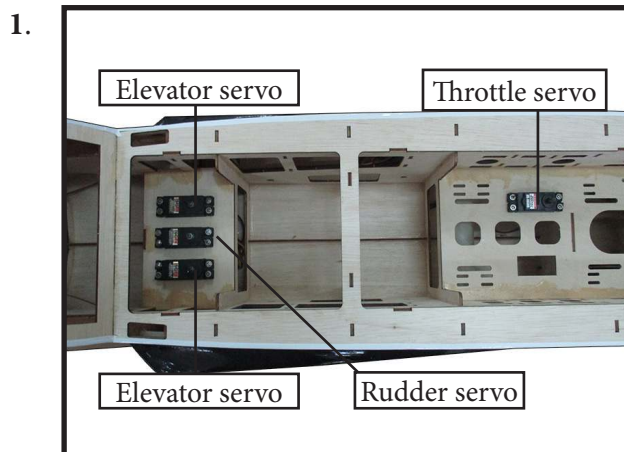

**THROTTLE SERVO ARM INSTALLATION**

Install adjustable servo connector in the servo arm as same as picture below:

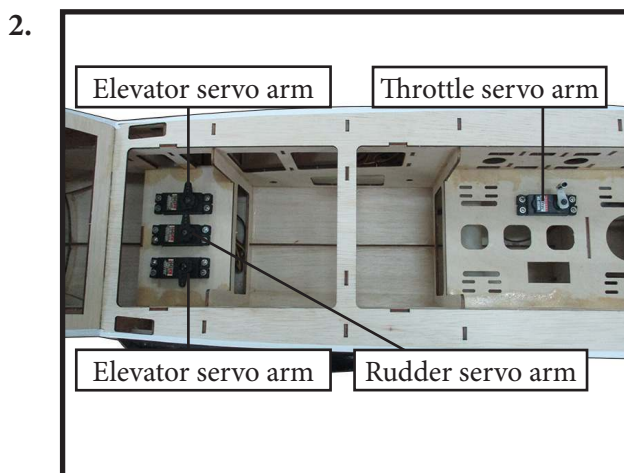
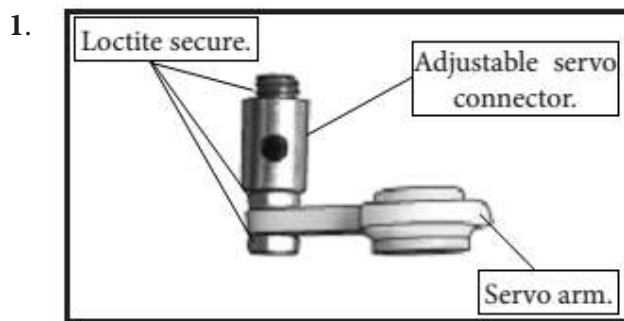

## INSTALLING THE RECEIVER SWITCH

Install the switch into the precut hole in the side, in the fuselage.

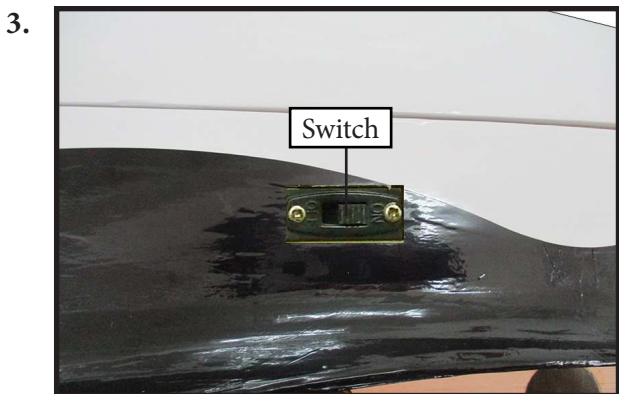
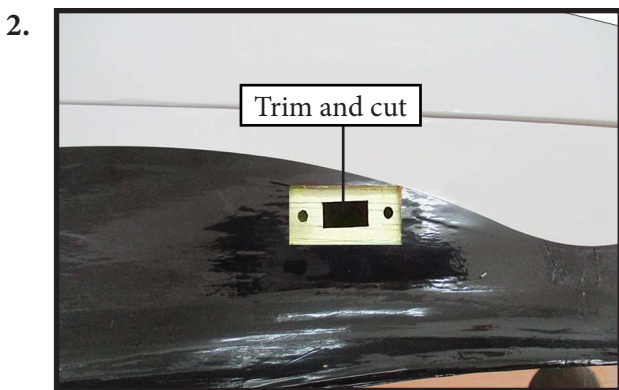
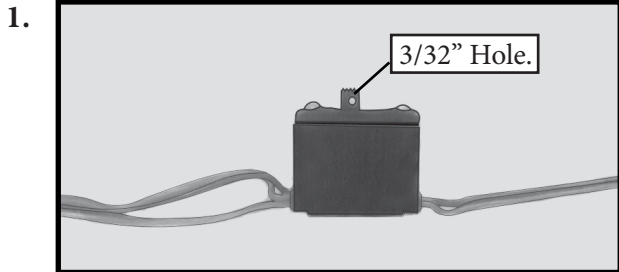

## INSTALLING THE ENGINE SWITCH

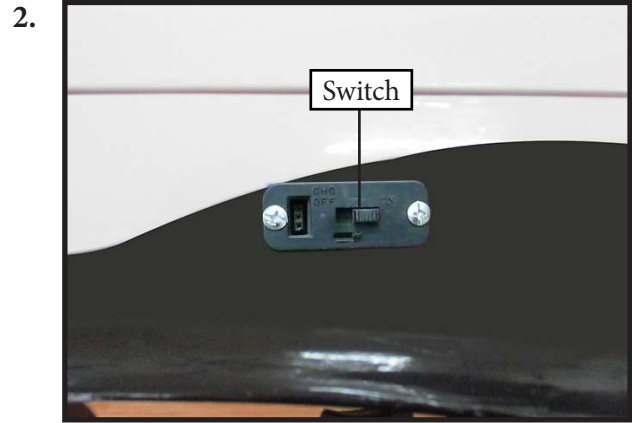
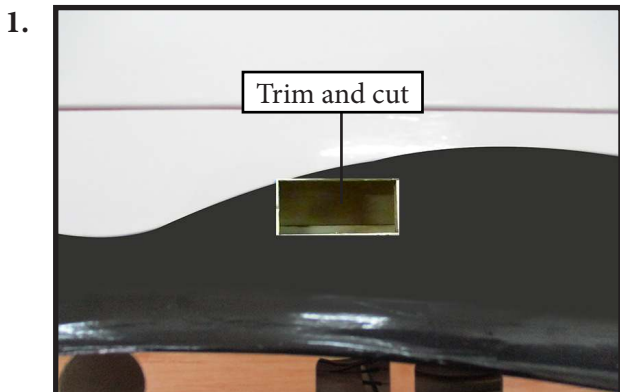

## INSTALLING THE STOPPER ASSEMBLY

Using a modeling knife, carefully cut off the rear portion of one of the 3 nylon tubes leaving 1/2" protruding from the rear of the stopper. This will be the fuel pick up tube.

Using a modeling knife, cut one length of silicone fuel line. Connect one end of the line to the weighted fuel pick up and the other end to the nylon pick up tube.

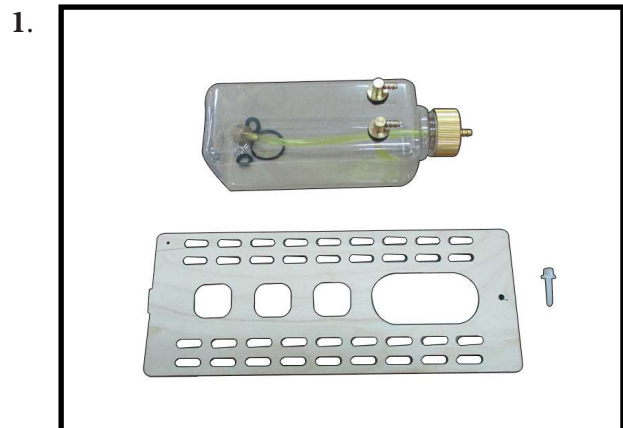

Carefully bend the second nylon tube up at a 45° angle. This tube is the vent tube.

Test fit the stopper assembly into the tank. It may be necessary to remove some of the flashing around the tank opening using a modeling knife. If flashing is present, make sure none falls into the tank.



With the stopper assembly in place, the weighted pick-up should rest away from the rear of the tank and move freely inside the tank. The top of the vent tube should rest just below the top of the tank. It should not touch the top of the tank.

When satisfied with the alignment of the stopper assembly tighten the 3 x 20mm machine screw until the rubber stopper expands and seals the tank opening. Do not over-tighten the assembly as this could cause the tank to split.

### FUEL TANK INSTALLATION

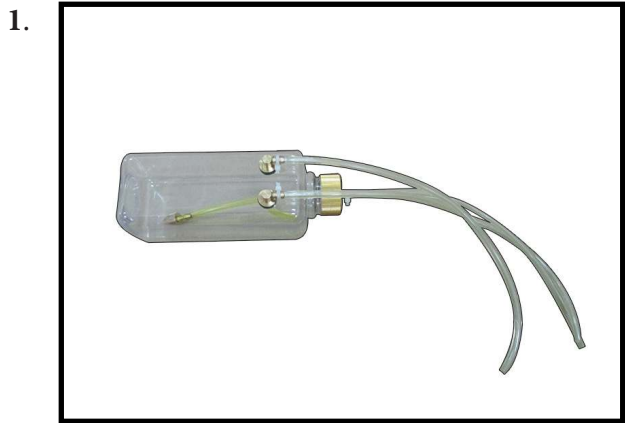

**!** *You should mark which tube is the vent and which is the fuel pickup when you attach fuel tubing to the tubes in the stopper. Once the tank is installed inside the fuselage, it may be difficult to determine which is which.*

Slide the fuel tank into the fuselage. Guide the lines from the tank through the hole in the firewall.

Use plywood template to hold in place the fuel tank with C/A glue to secure the fuel-tank inside the fuselage.

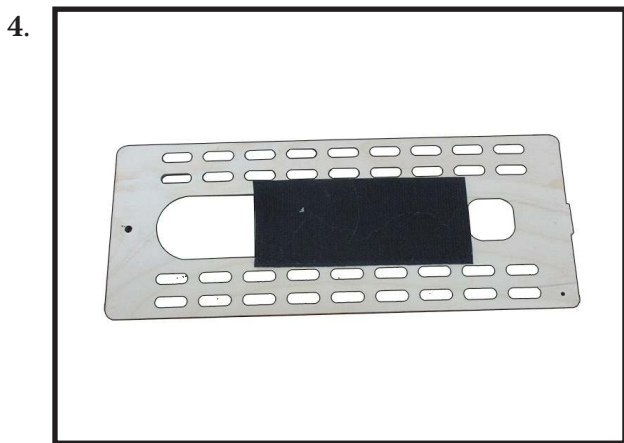
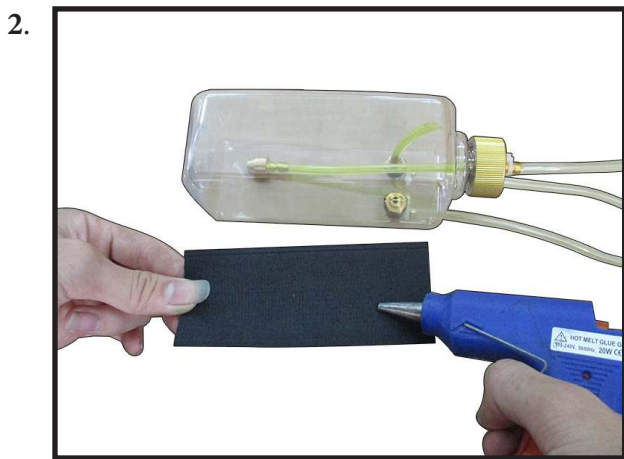



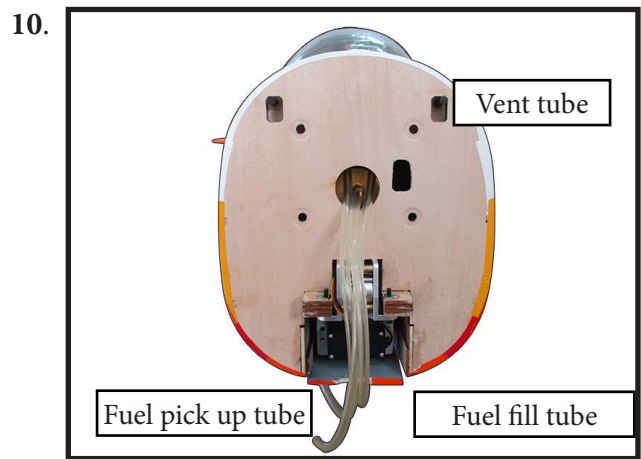
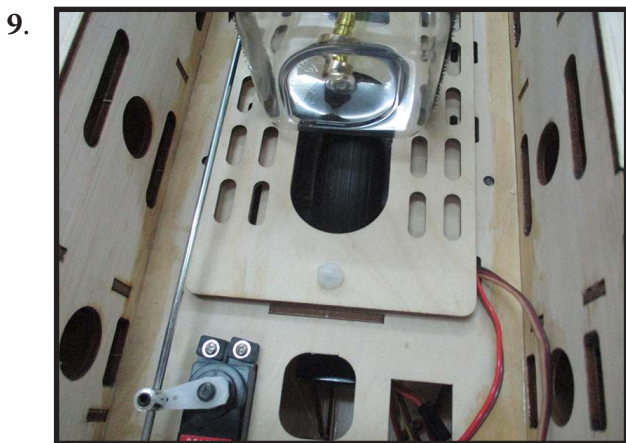
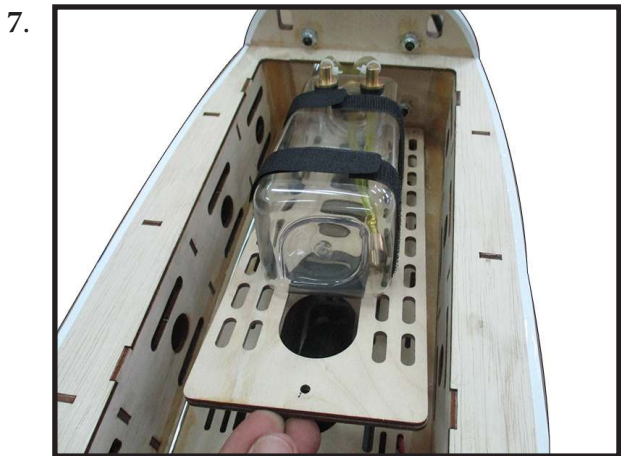

Connect the lines from the tank to the engine and muffler. The vent line will connect to the muffler and the line from the clunk to the carburetor.

-  *Blow through one of the lines to ensure the fuel lines have not become kinked inside the fuel tank compartment. Air should flow through easily.*

### MOUNTING THE ENGINE

Please see images below.

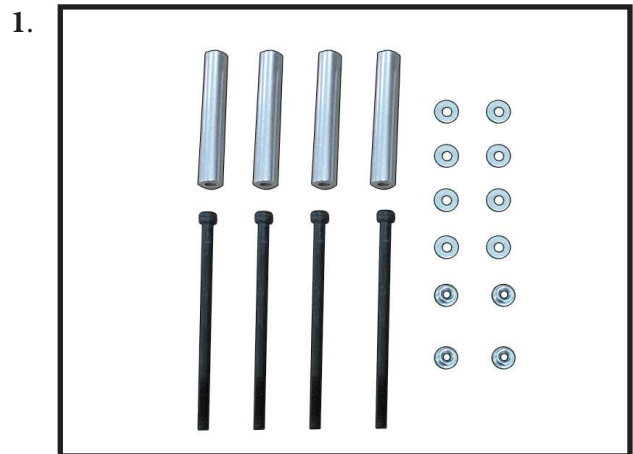

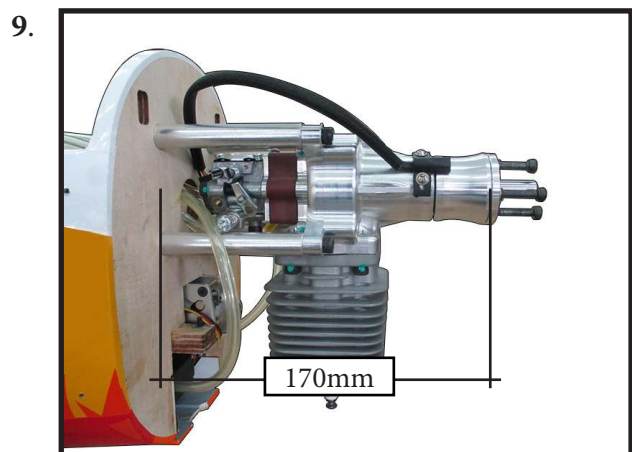
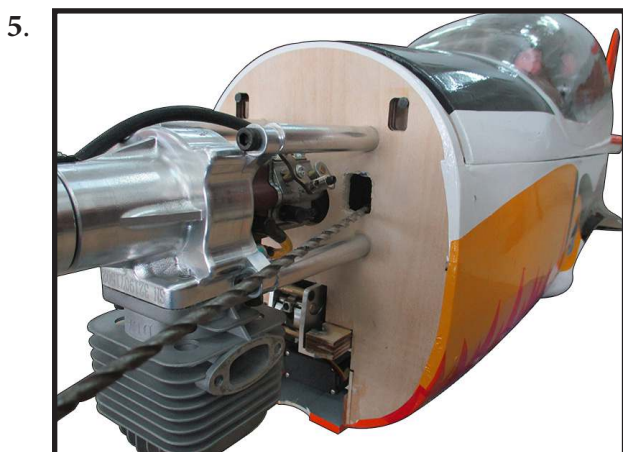
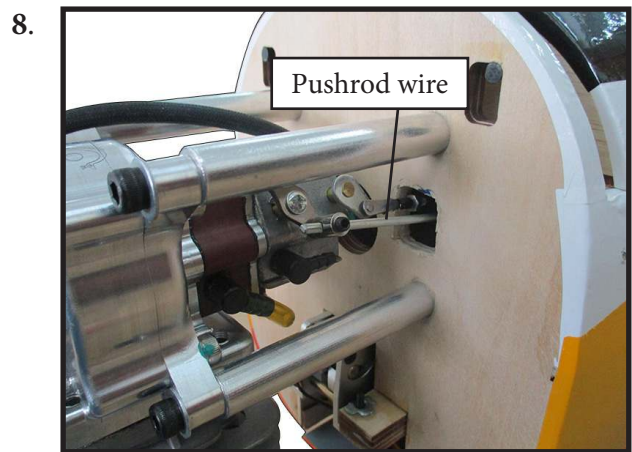
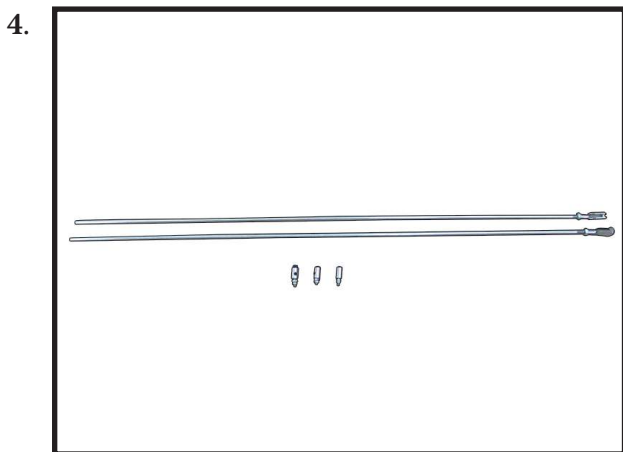
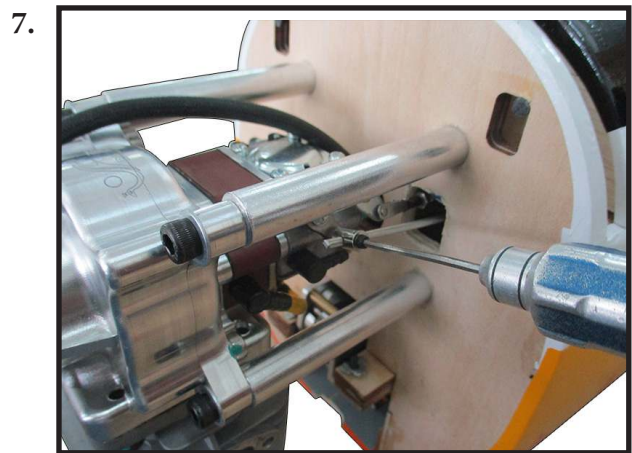
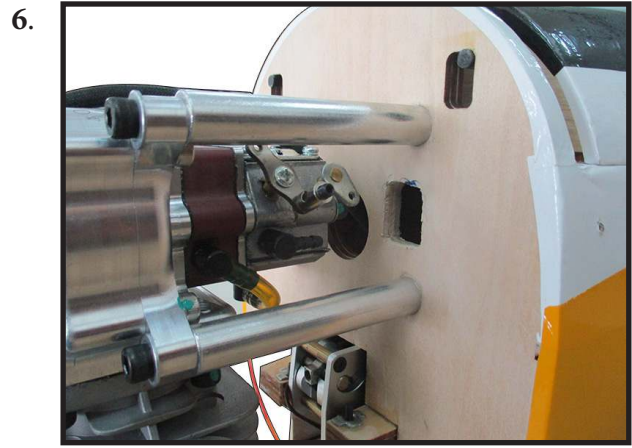
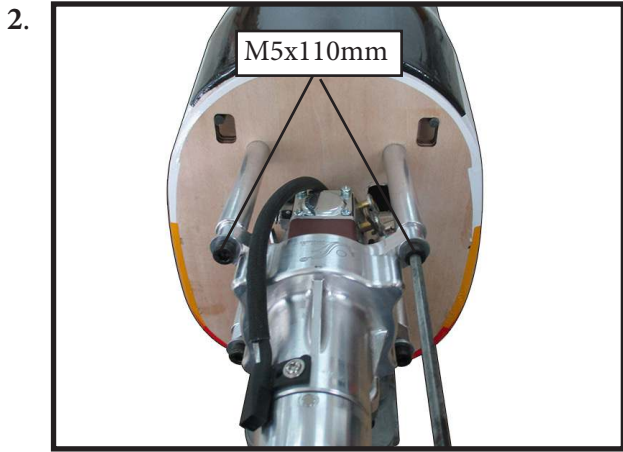



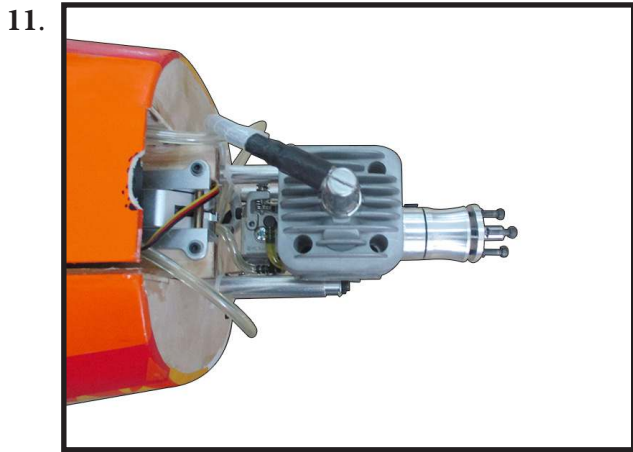
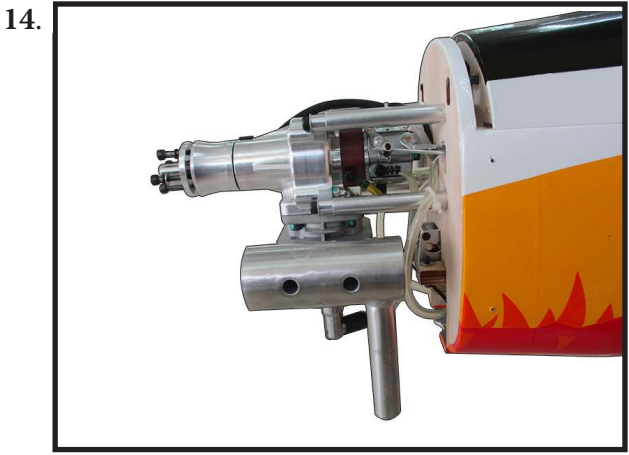
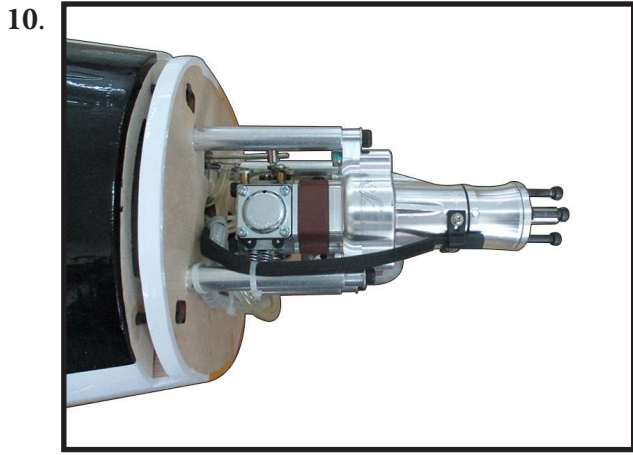

Reinstall the servo horn by sliding the connector over the pushrod wire. Center the throttle stick and trim and install the servo horn perpendicular to the servo center line.

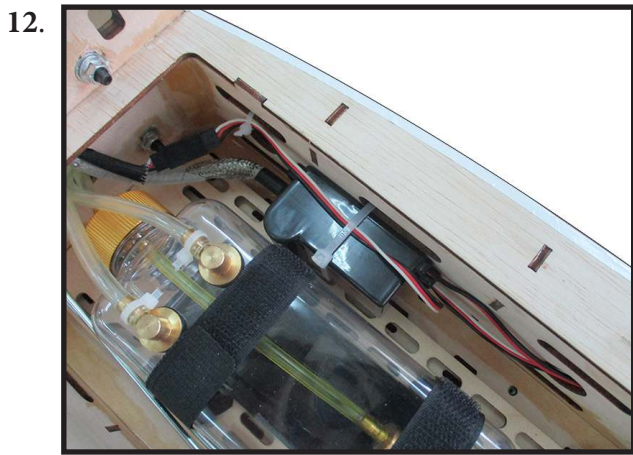

Move the throttle stick to the closed position and move the carburetor to closed. Use a 2.5mm hex wrench to tighten the screw that secures the throttle pushrod wire. Make sure to use threadlock on the screw so it does not vibrate loose.

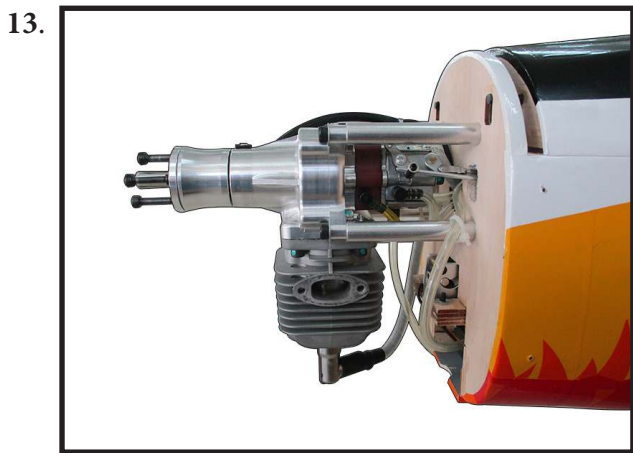

## COWLING

Please see below pictures.

1.



2.



3.



4.



Tape the cowl to the fuselage using low-tack tape.

5.

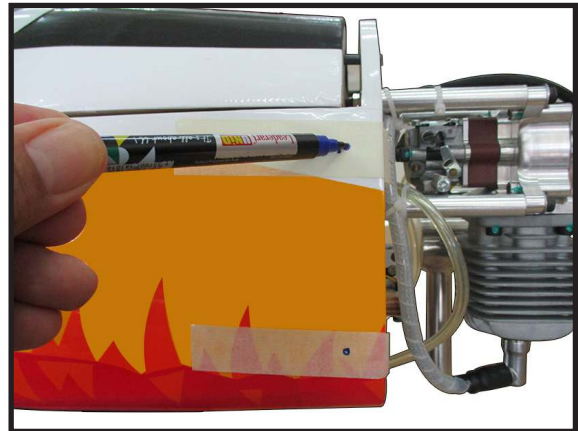

6.

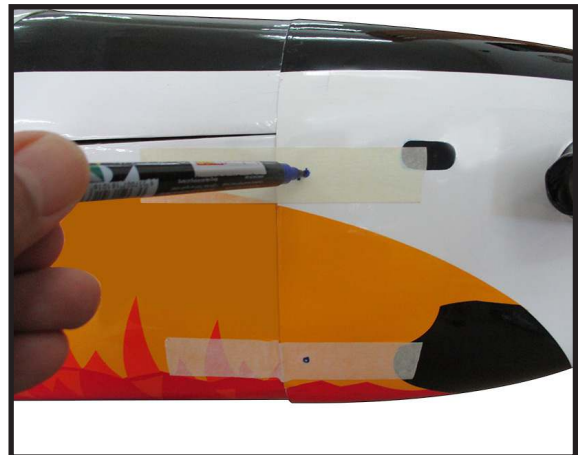

Use a drill and drill bit to drill the holes for the cowl mounting screws. Make sure the cowl position is correct before drilling each hole.



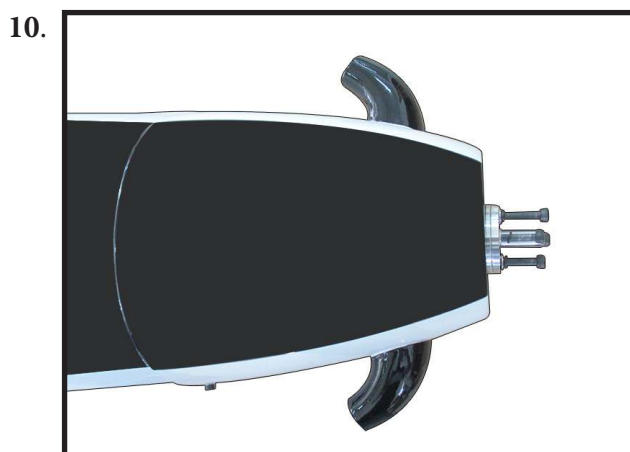
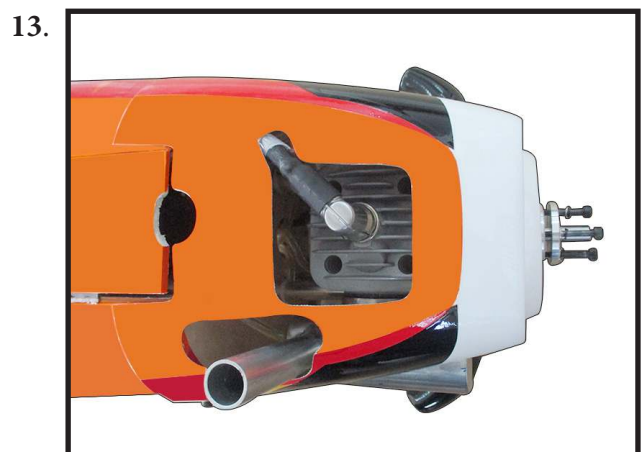
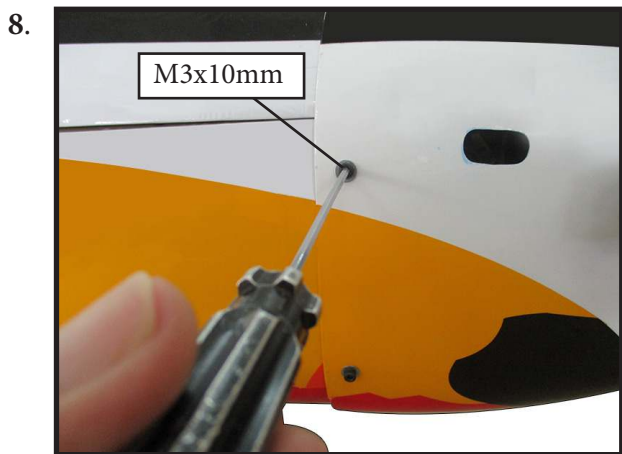
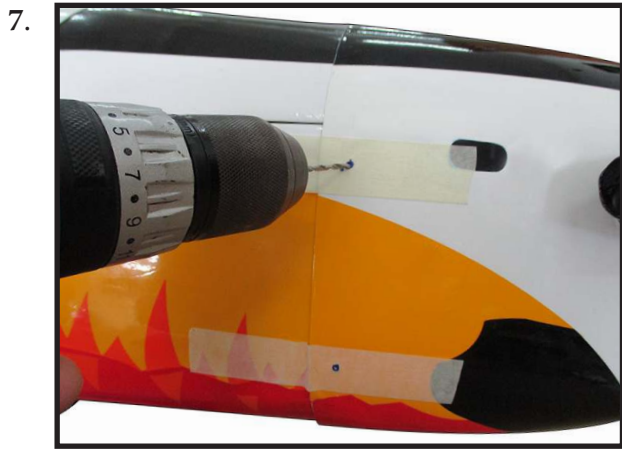

## ELECTRIC POWER CONVERSION

Locate the items necessary to install the electric power conversion included with your model.

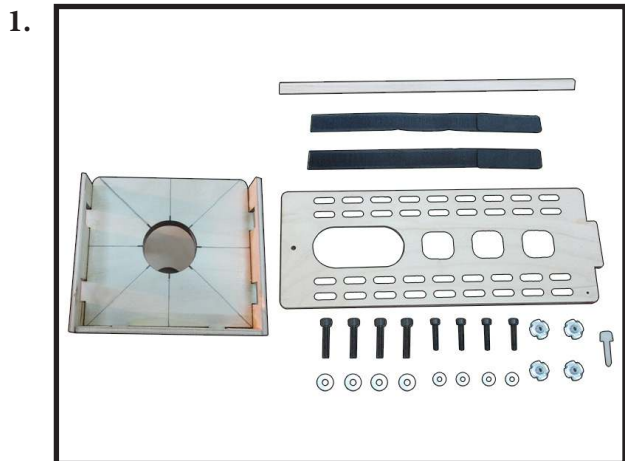

Recommend the items necessary to install the electric power conversion parts included with your model.

- **Motor: 180 - 3000 Watts**
- **Propeller: 20x12 ~ 22x11**
- **ESC: 80A - 100A**
- **10S Lipo**

Attach the electric motor box to the firewall centered with the cross lines drawn on the electric motor box and firewall. Using M5x25mm to secure the motor box to the firewall. Please see pictures below.

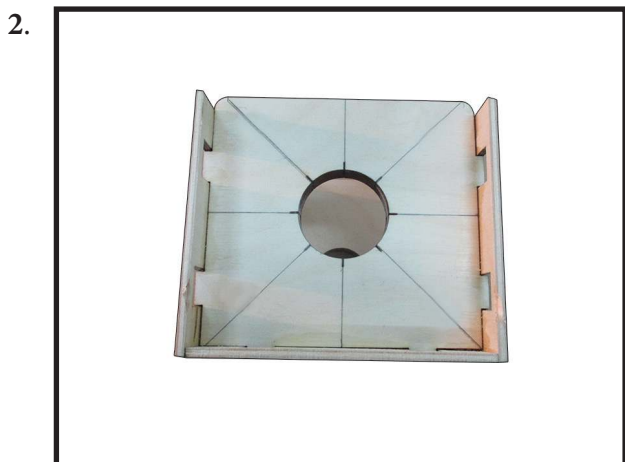

Attach the motor mount to the front of the electric motor box using four 5mm blind nut, four M5x25mm hex head bolts to secure the motor. Please see picture shown.

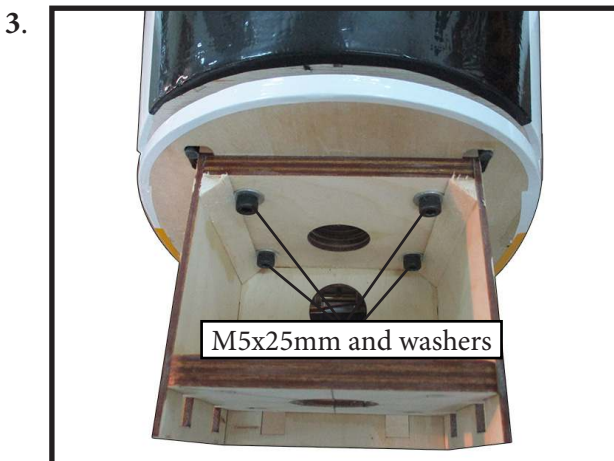

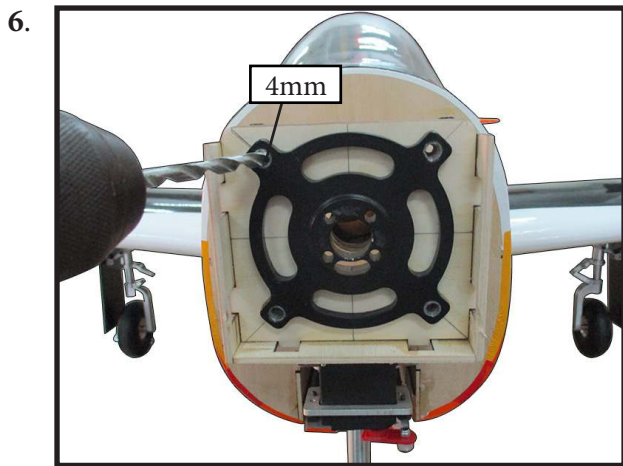

Then, use 7mm drill bit to enlarge the holes on the electric motor box.

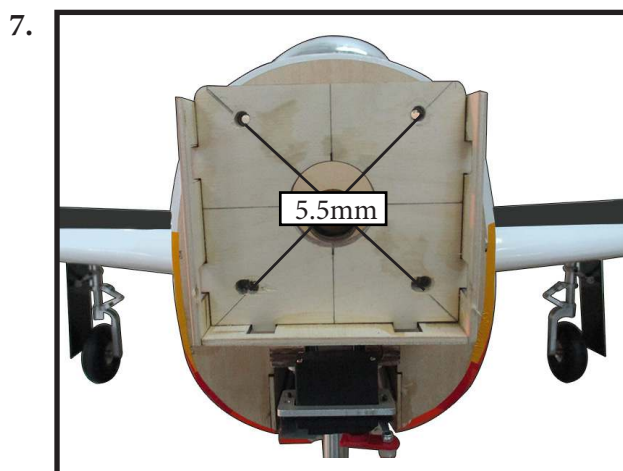

Attach the motor to the front of the electric motor box using four 5mm blind nut, four M4x20mm hex head bolts to secure the motor. Please see picture shown.

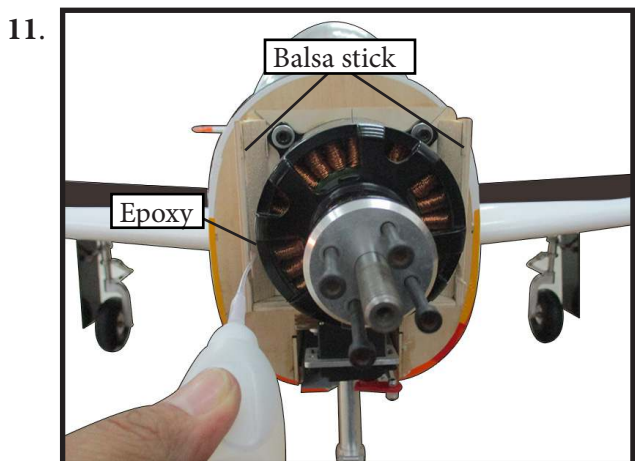
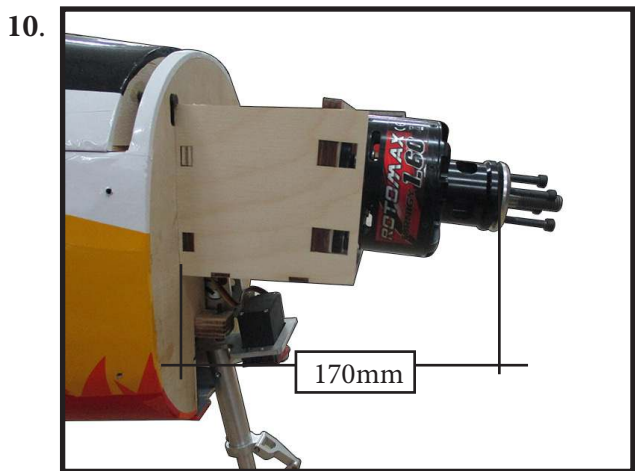
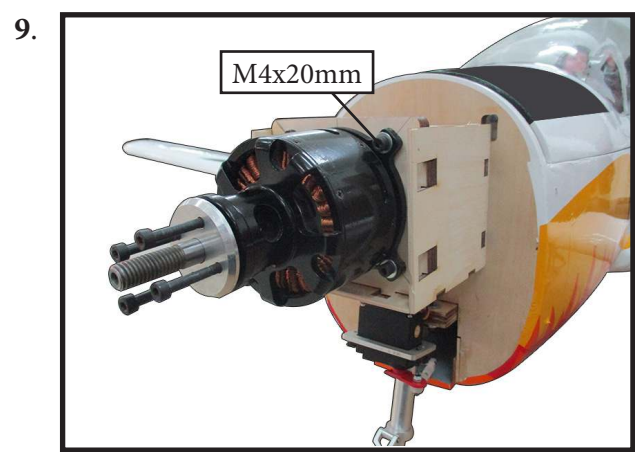

Attach the speed control to the side of the motor box using two-sided tape and tie wraps. Connect the appropriate leads from the speed control to the motor. Make sure the leads will not interfere with the operation of the motor.



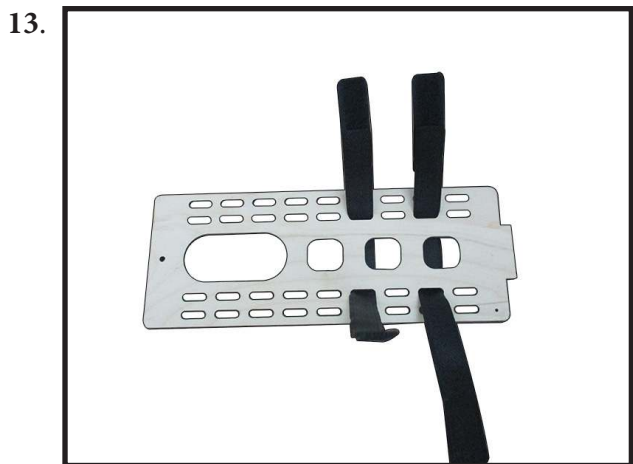
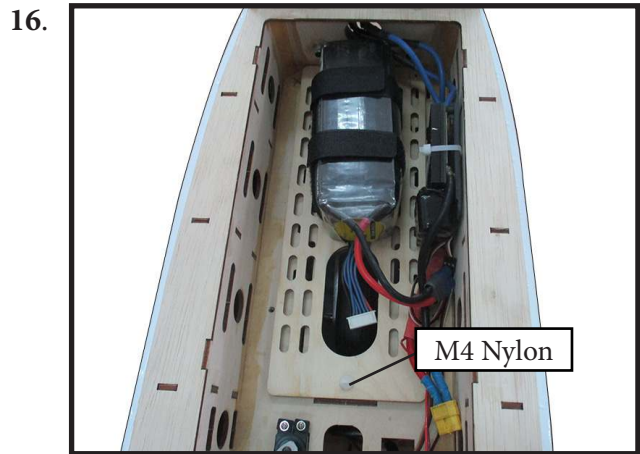
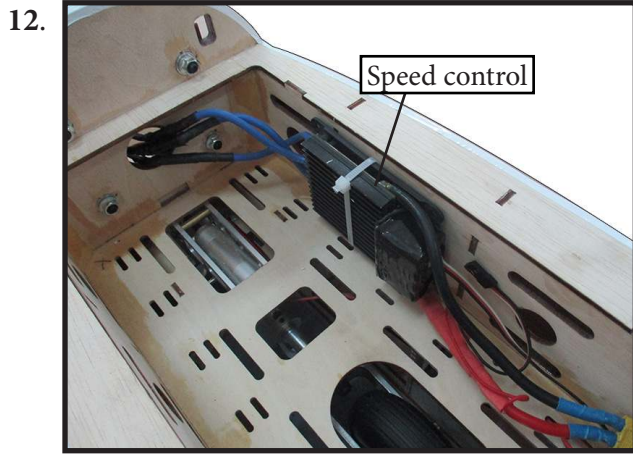

**INSTALLING THE SPINNER**

Install the spinner backplate, propeller and spinner cone.

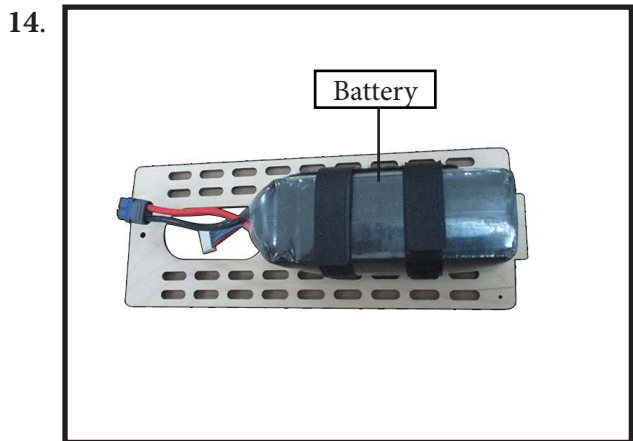

 The propeller should not touch any part of the spinner cone. If it does, use a sharp modeling knife and carefully trim away the spinner cone where the propeller comes in contact with it.

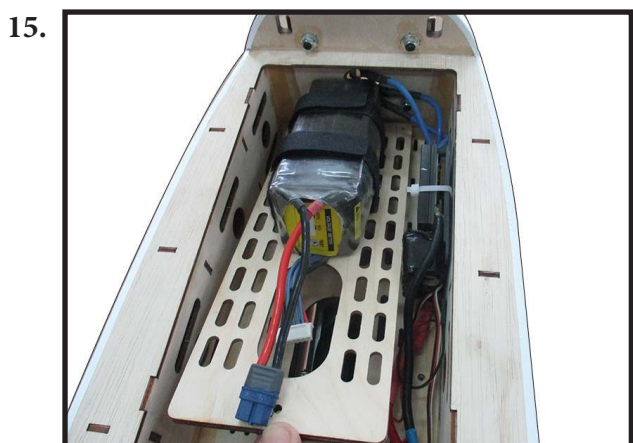



# NOSE GEAR INSTALLATION

Locate the parts needed to attach the nose gear.

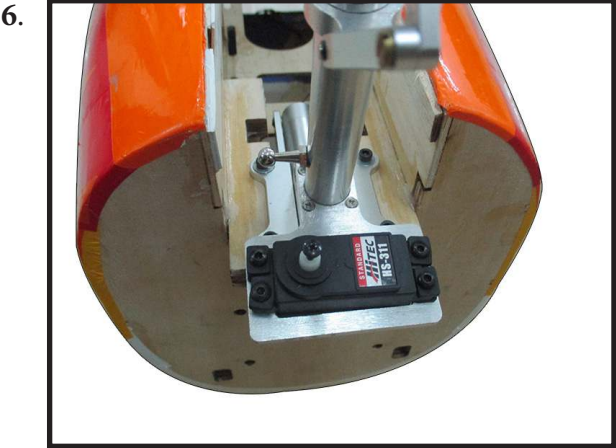
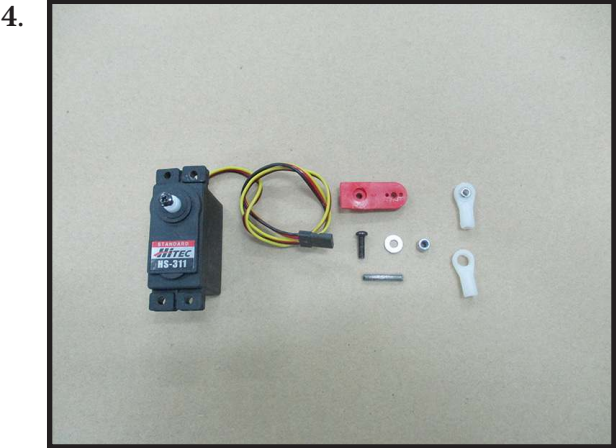
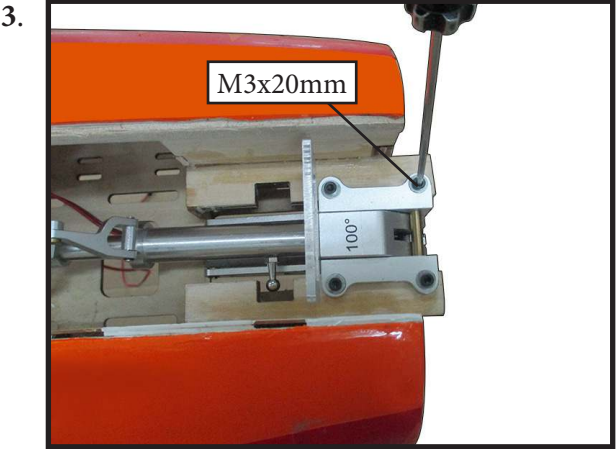
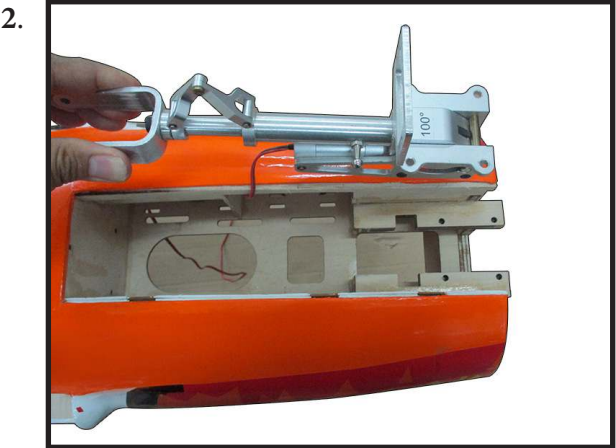
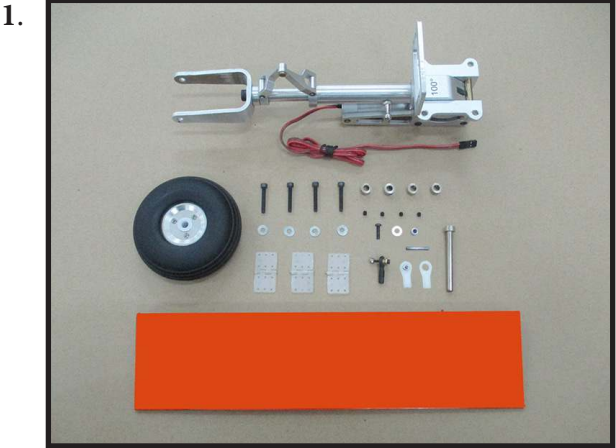

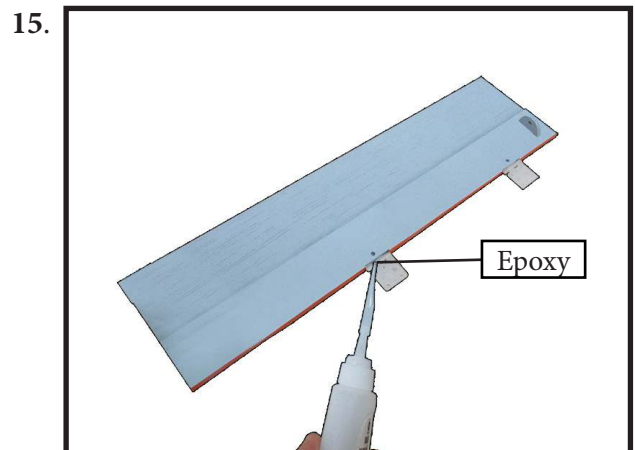
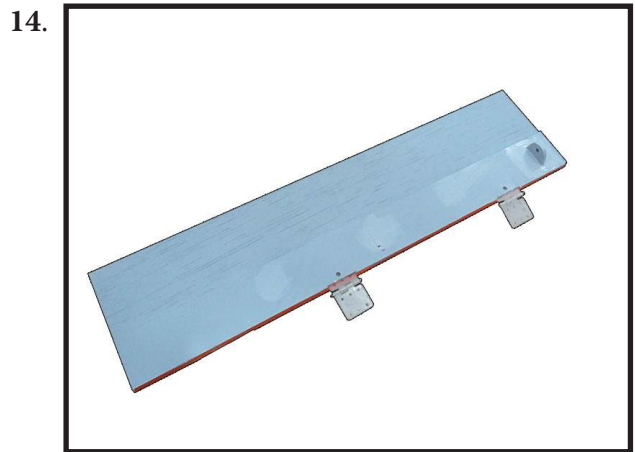
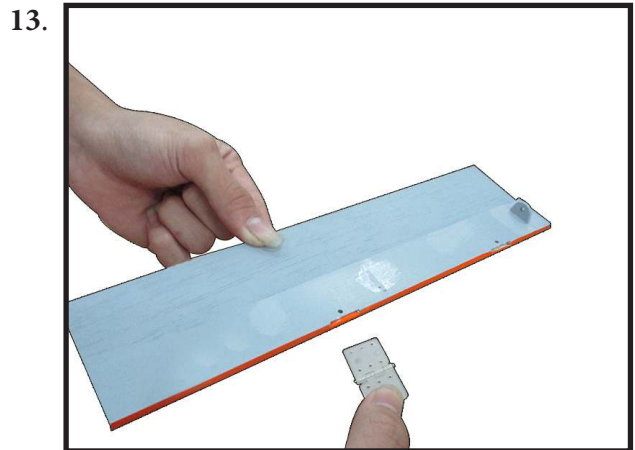
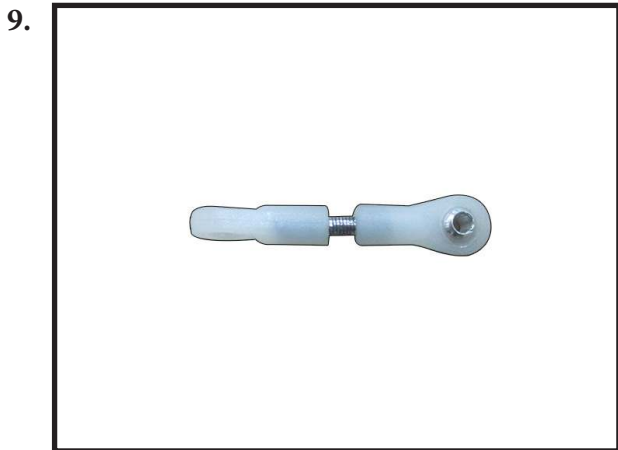
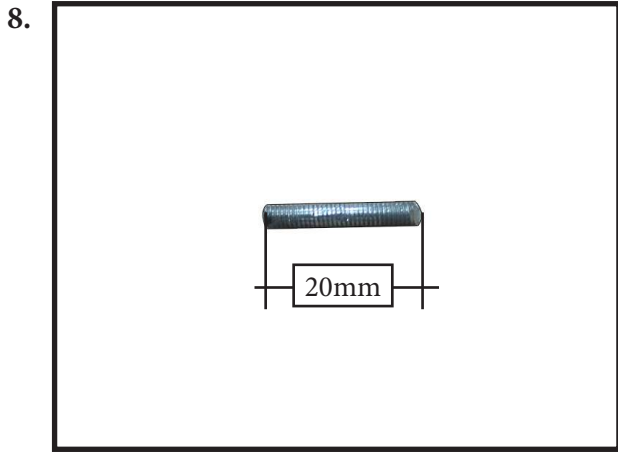

16.

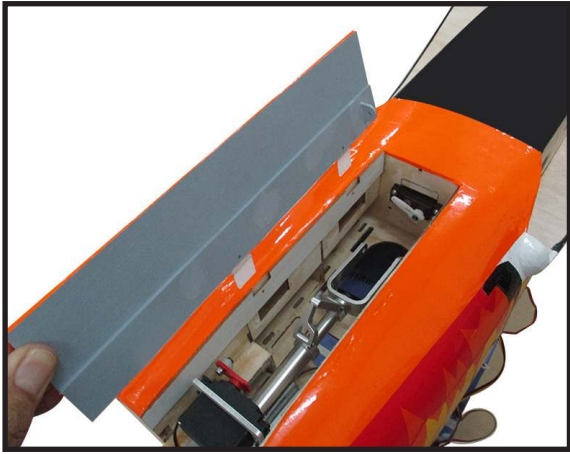

20.

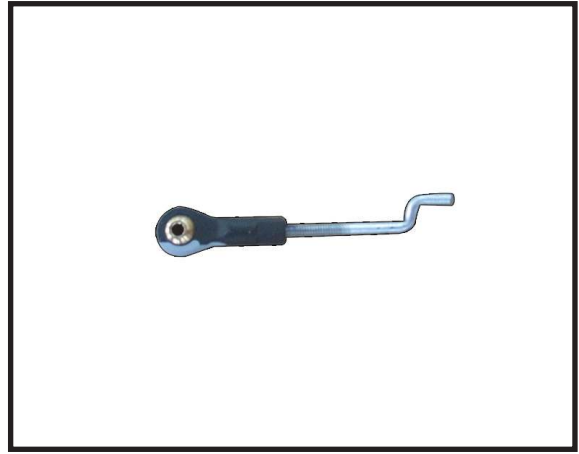

17.

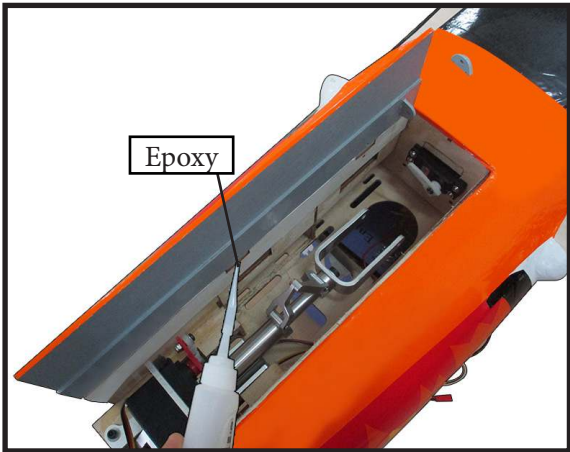

21.



18.



22.



19.

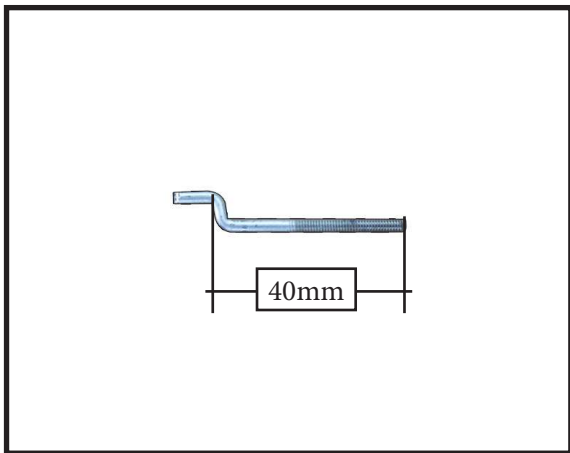

23.

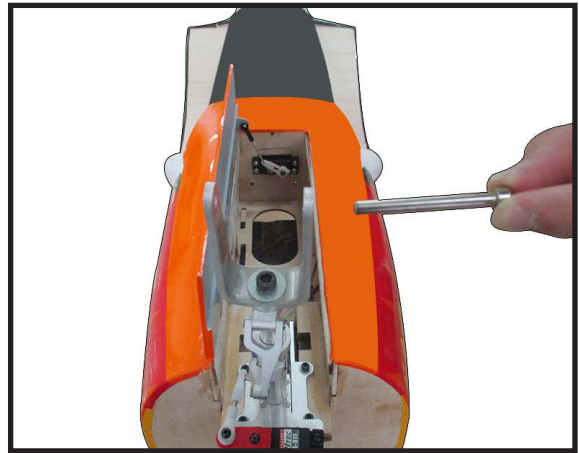



24.



28.

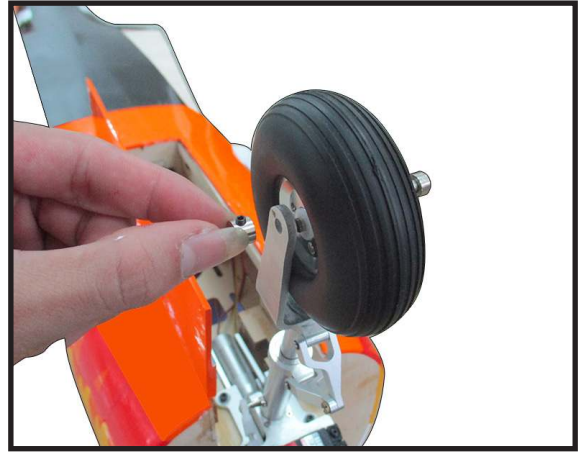

25.

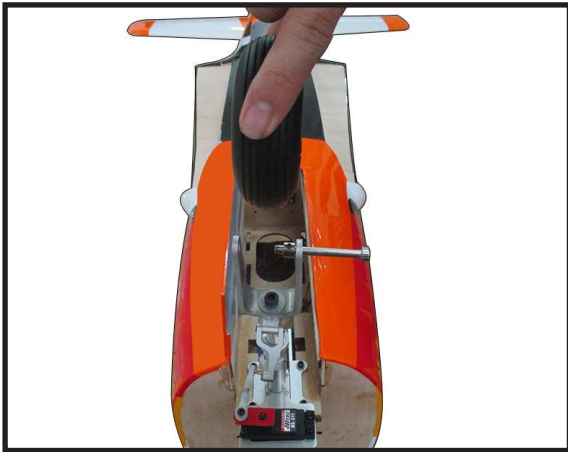

29.

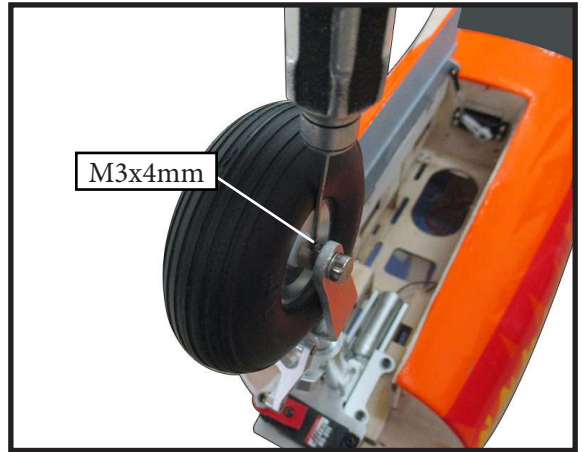

26.



30.



27.



31.





## INSTALL NAIL HINGE ELEVATOR

Test fit the hinges into the elevator, and then the hinges into the tail. Ensure that the hinge pockets line up, and that the hinges move freely.

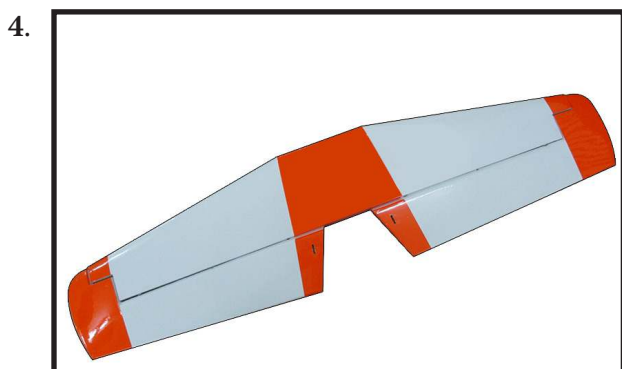
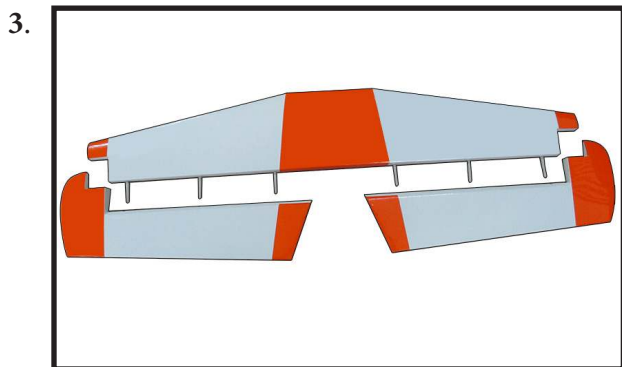
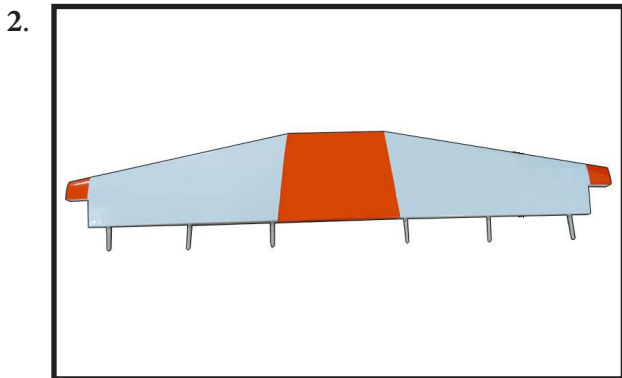
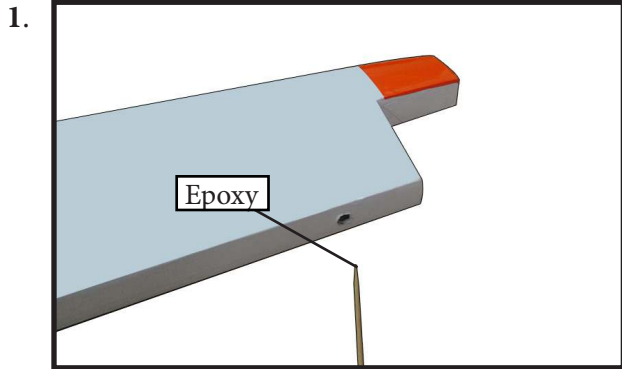

## INSTALL ELEVATOR CONTROL HORN

Install the elevator control horn using the same method as same as the elevator control horns.

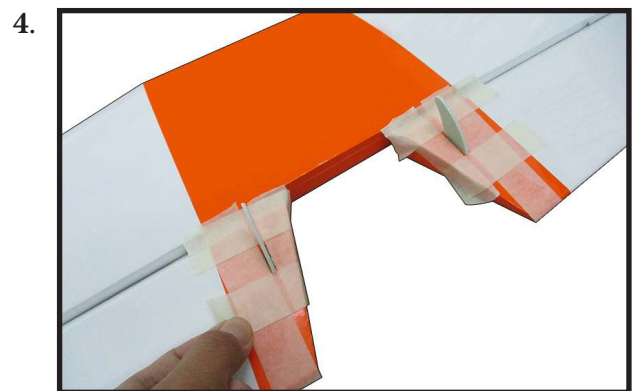
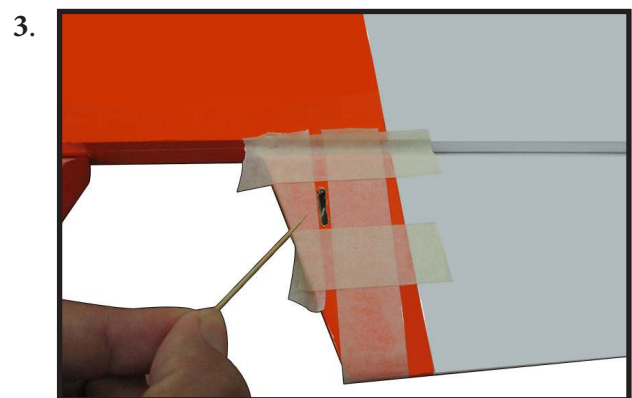
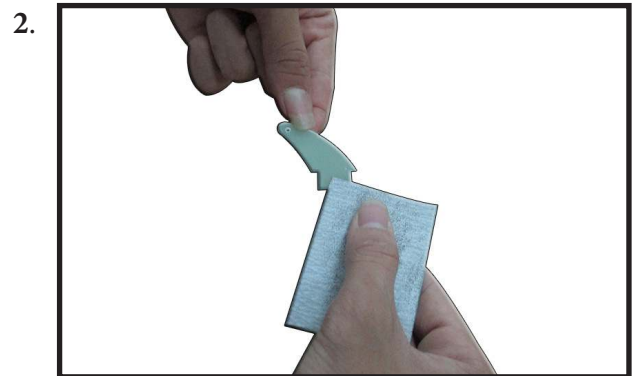
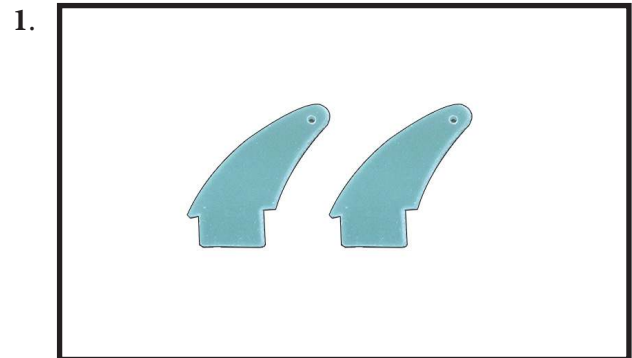

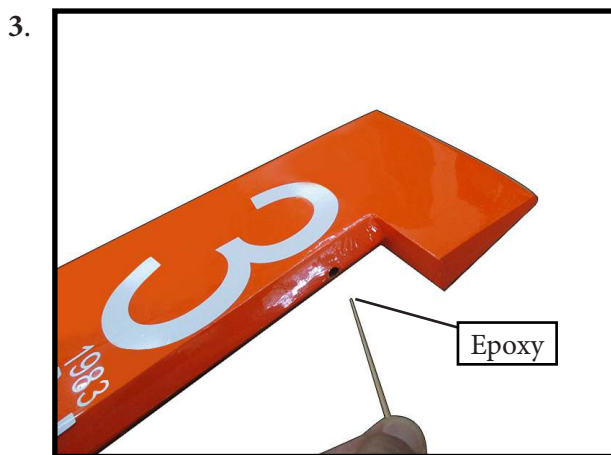

### HINGING THE RUDDER

Glue the top three rudder hinges in place using the same techniques used to hinge the elevator.

The lower hinge will be glued when the fin/rudder assembly is attached to the fuselage.



## INSTALL RUDDER CONTROL HORN

Repeat steps to install the rudder control horn as same as steps done for elevator.

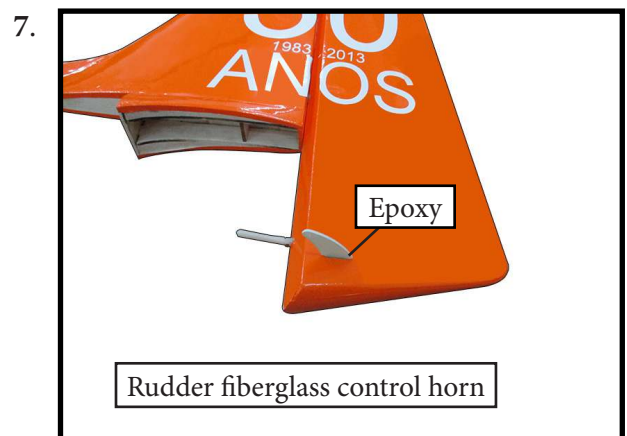
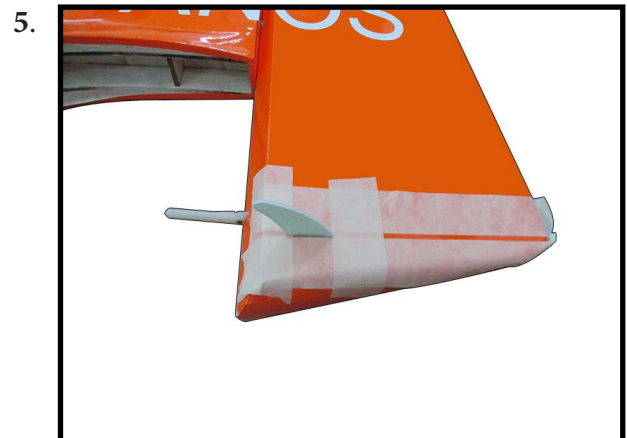
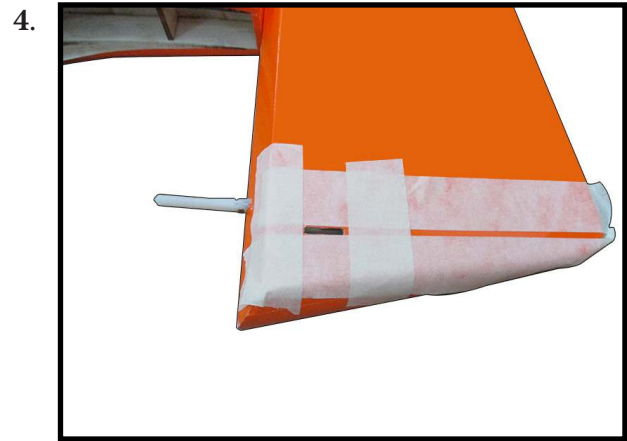
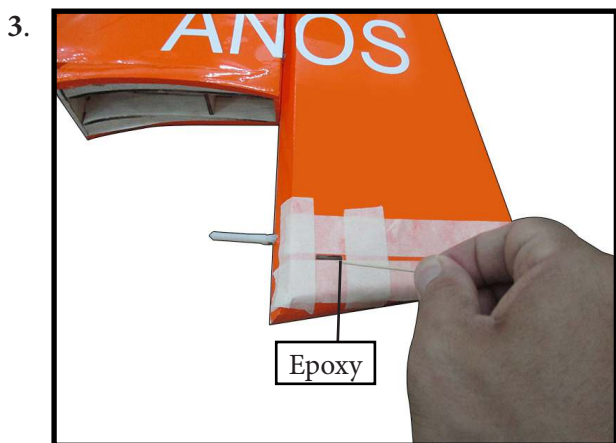
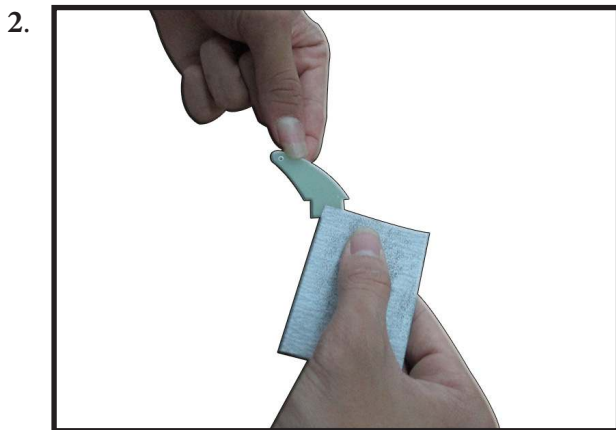
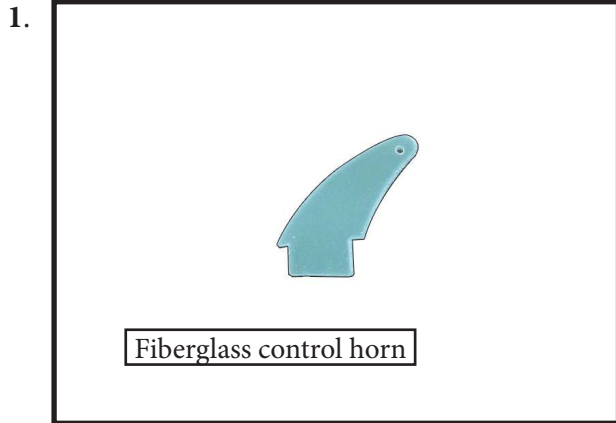

## INSTALLING THE HORIZONTAL STABILIZER

### Required Parts

- Fuselage assembly
- Tail Set(Rudder and Elevator)

### Required Tools and Adhesives

- Ruler, Pen, Knife
- 30-minute epoxy

Using a ruler and a pen, locate the centerline of the horizontal stabilizer, at the trailing edge, and place a mark. Use a triangle and extend this mark, from back to front, across the top of the stabilizer. Also extend this mark down the back of the trailing edge of the stabilizer.

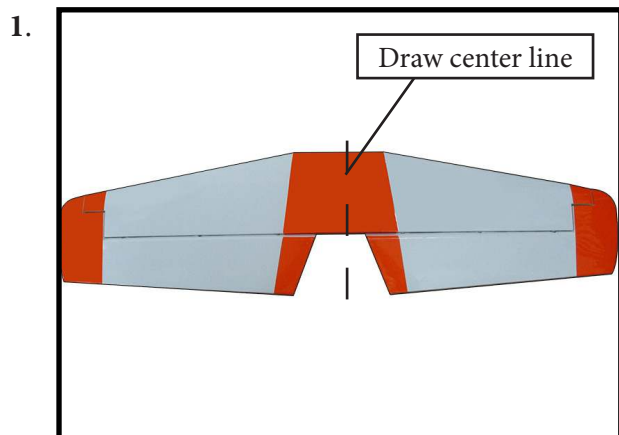

Using a modeling knife, carefully remove the covering at mounting slot of horizontal stabilizer (both side of fuselage).

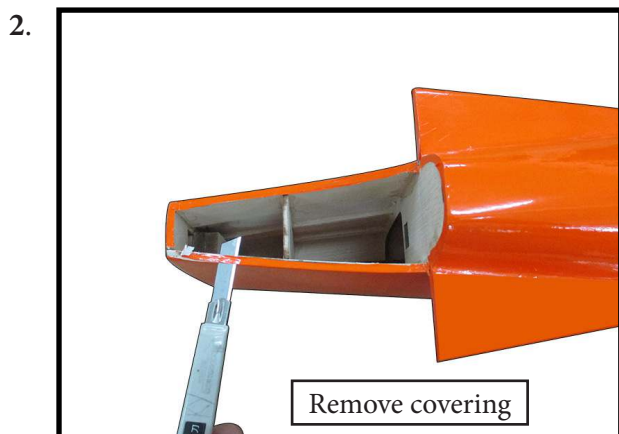

Slide the stabilizer into place in the precut slot in the rear of the fuselage. The stabilizer should be pushed firmly against the front of the slot.

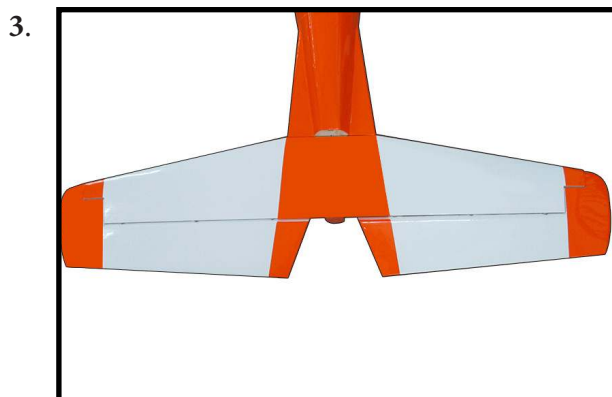

With the stabilizer held firmly in place, use a pen and draw lines onto the stabilizer where it and the fuselage sides meet. Do this on both the right and left sides and top and bottom of the stabilizer.



Remove the stabilizer. Using the lines you just drew as a guide, carefully remove the covering from between them using a modeling knife.

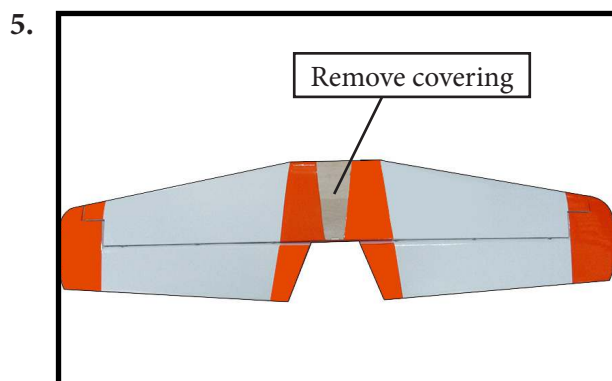



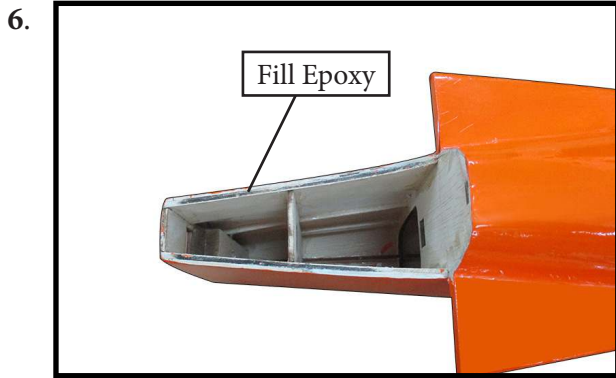

 When cutting through the covering to remove it, cut with only enough pressure to only cut through the covering itself. Cutting into the balsa structure may weaken it.

Using a modeling knife, carefully remove the covering that overlaps the stabilizer mounting platform sides in the fuselage. Remove the covering from both the top and the bottom of the platform sides.

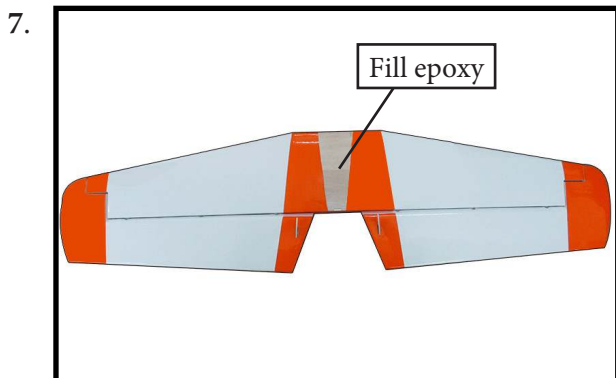

When you are sure that everything is aligned correctly, mix up a generous amount of 30 Minute Epoxy. Apply a thin layer to the top and bottom of the stabilizer mounting area and to the stabilizer mounting platform sides in the fuselage. Slide the stabilizer in place and realign. Double check all of your measurements once more before the epoxy cures. Hold the stabilizer in place with T-pins or masking tape and remove any excess epoxy using a paper towel and rubbing alcohol.

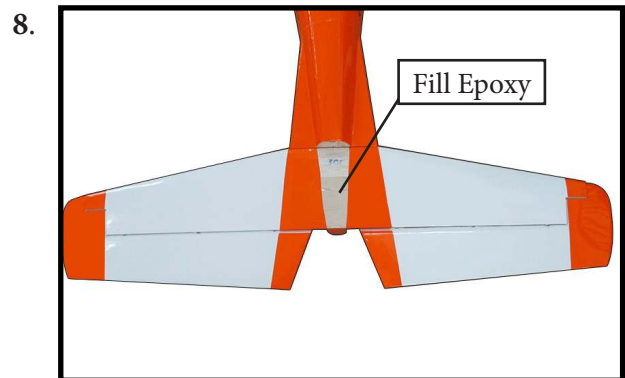

## INSTALLING VERTICAL FIN

### Required Parts

- Fuselage assembly
- Tail Set(Rudder and Elevator)

### Required Tools and Adhesives

- Ruler, Pen, Knife
- 30-minute epoxy



Using a modeling knife, remove the covering from over the precut hinge slot cut into the lower rear portion of the fuselage.

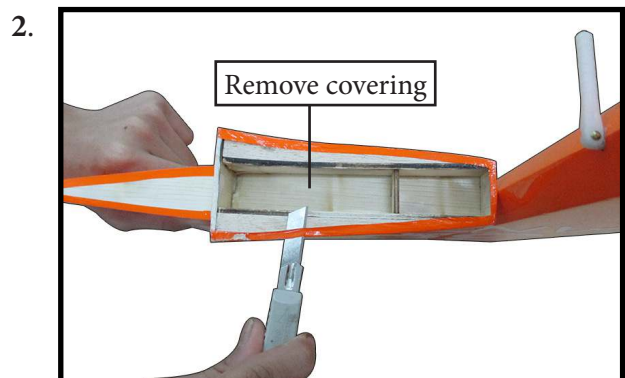

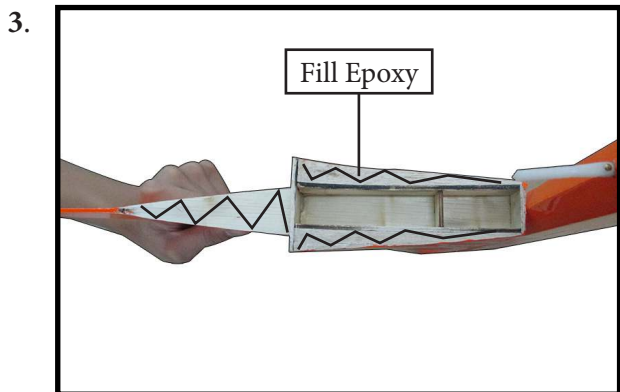

While holding the vertical stabilizer firmly in place, use a pen and draw a line on each side of the vertical stabilizer where it meets the top of the fuselage.

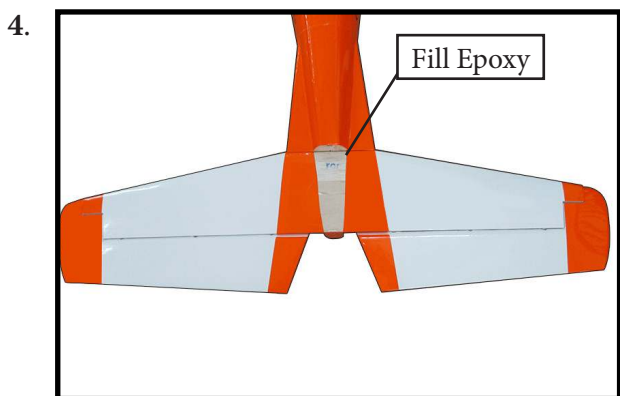

Slide the vertical stabilizer back in place. Using a triangle, check to ensure that the vertical stabilizer is aligned 90° to the horizontal stabilizer.

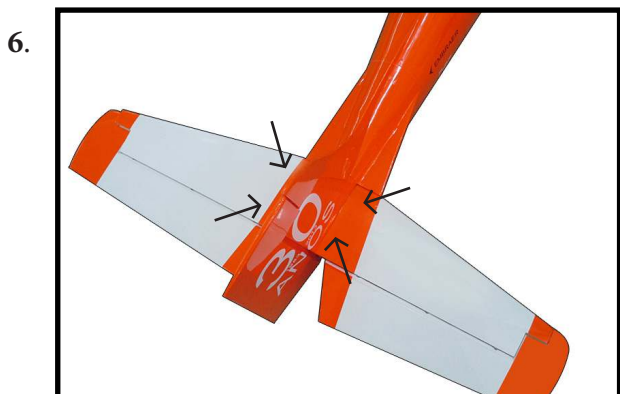
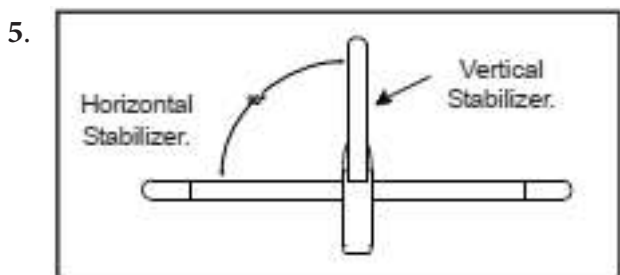

When you are sure that everything is aligned correctly, mix up a generous amount of Flash 30 Minute Epoxy. Apply a thin layer to the mounting slot and to bottom of the vertical stabilizer mounting area. Apply epoxy to the bottom and top edges of the filler block and to the lower hinge also. Set the stabilizer in place and realign. Double check all of your measurements once more before the epoxy cures. Hold the stabilizer in place with T-pins or masking tape and remove any excess epoxy using a paper towel and rubbing alcohol. Allow the epoxy to fully cure before proceeding.

### ELEVATOR PUSHROD INSTALLATION

Locate items necessary to install elevator pushrod.



Elevator pushrods assembly as pictures below.

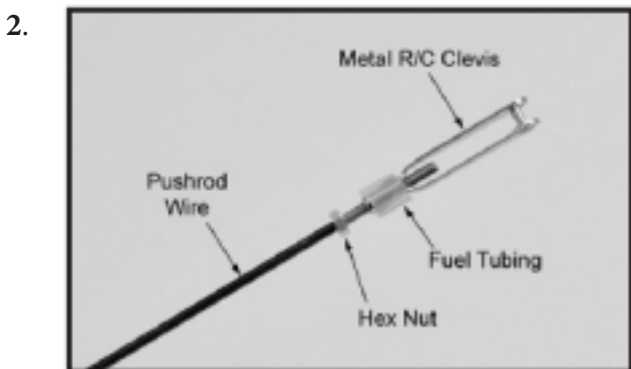

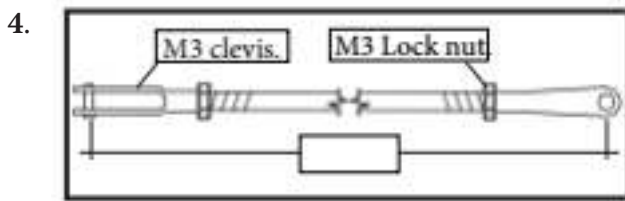
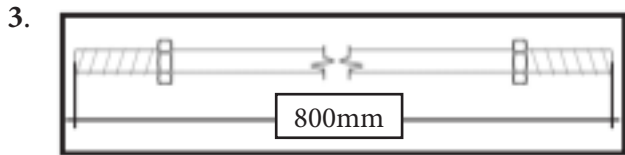

**RUDDER PUSHROD  
INSTALLATION**

Locate items necessary to install rudder pushrod.



Rudder pushrods assembly as pictures below.

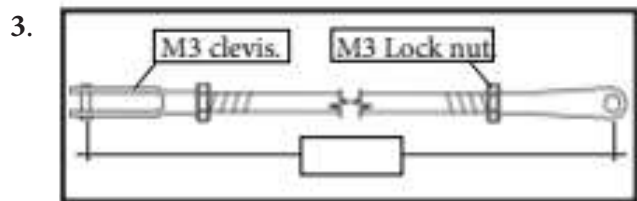
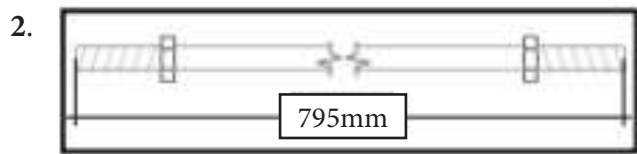



# INSTALLATION COCKPIT, PILOT AND CANOPY

Locate items necessary to install.







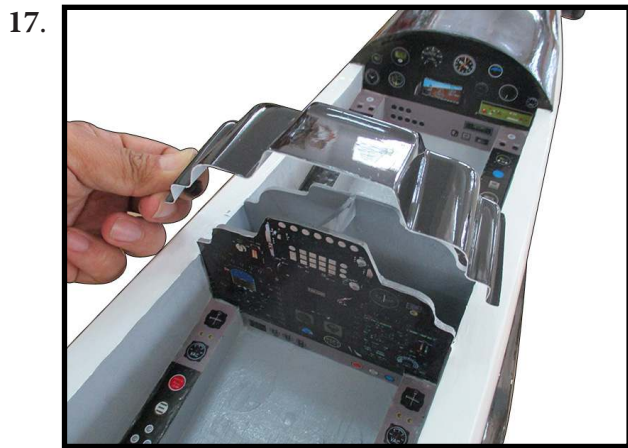
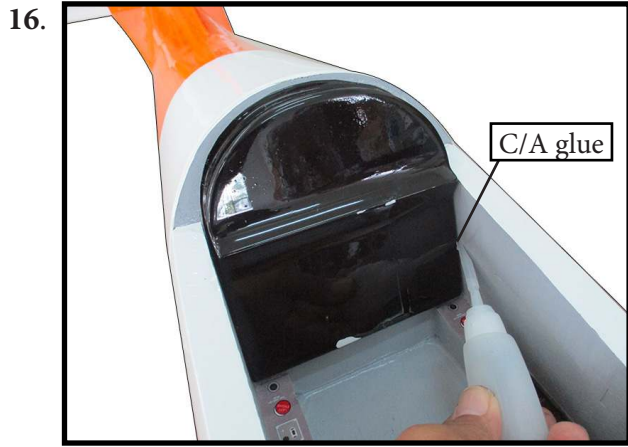



24.



28.



25.



29.



26.

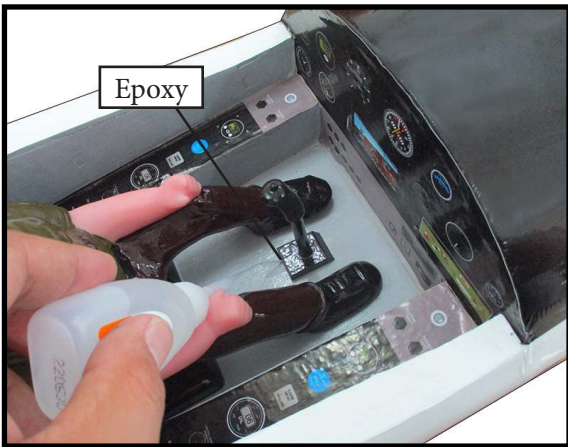

30.

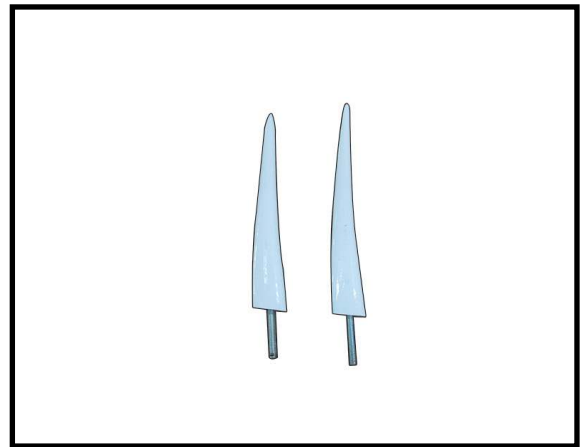

27.



31.



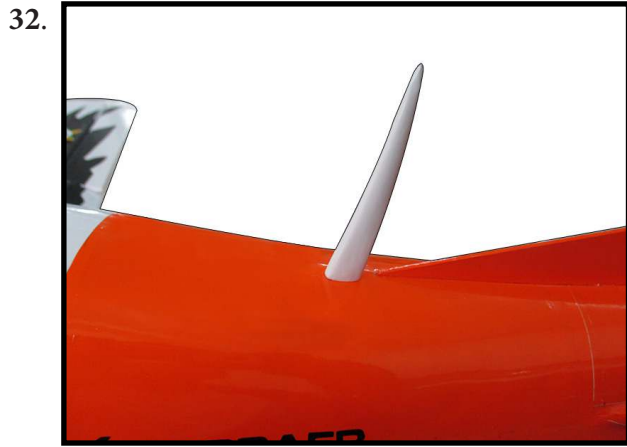

Route the antenna in the antenna tube inside the fuselage and secure it to the bottom of fuselage using a plastic tape.



### INSTALLING THE BATTERY-RECEIVER

Plug the servos leads and the switch lead into the receiver. Plug the battery pack lead into the switch also.

Wrap the receiver and battery pack in the protective foam rubber to protect them from vibration.

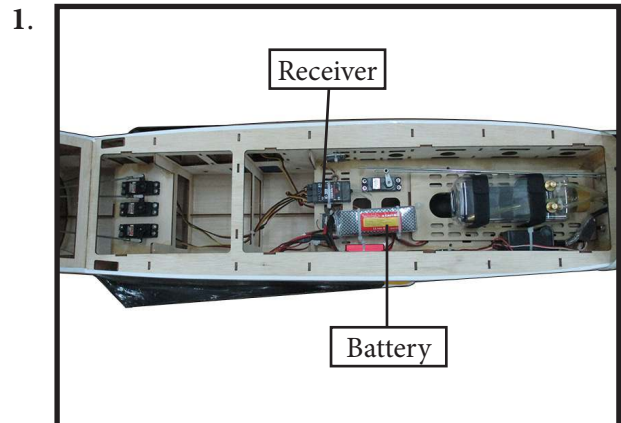

### ATTACHMENT WING-FUSELAGE

Attach the aluminium tube into fuselage.

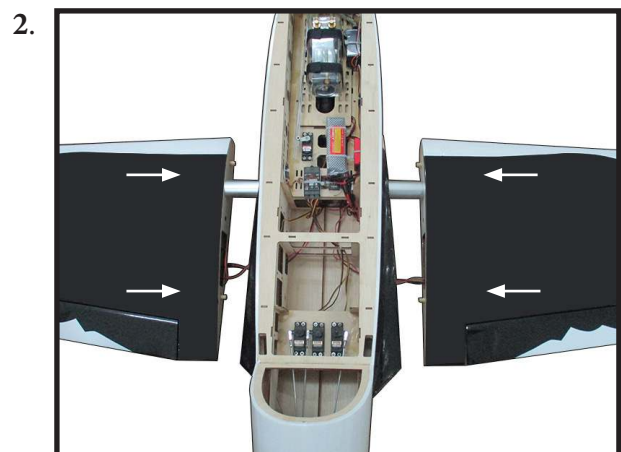
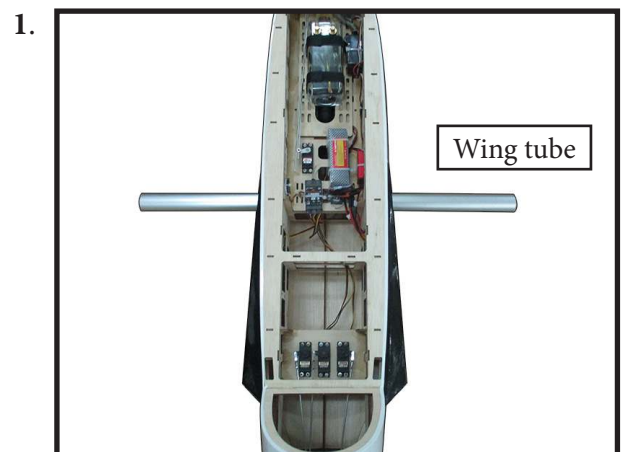

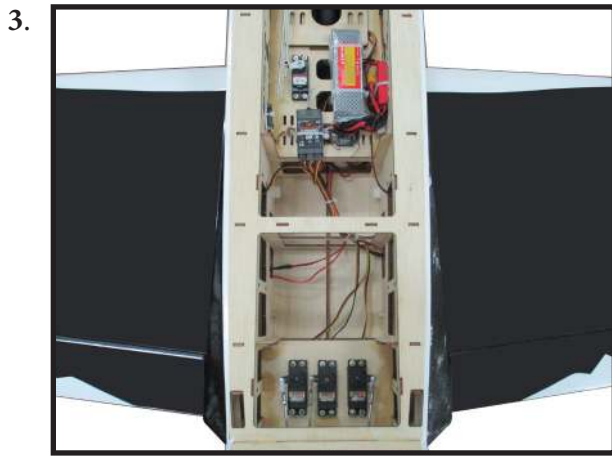

### APPLY THE DECALS

1) If all the decals are precut and ready to stick. Please be certain the model is clean and free from oily fingerprints and dust. Position decal on the model where desired, using the photos on the box and aid in their location.

2) If all the decals are not precut, please use scissors or a sharp hobby knife to cut the decals from the sheet. Please be certain the model is clean and free from oily fingerprints and dust. Position decal on the model where desired, using the photos on the box and aid in their location.

### BALANCING

1) It is critical that your airplane be balanced correctly. Improper balance will cause your plane to lose control and crash. **THE CENTER OF GRAV 100-115MM FROM THE LEADING EDGE OF THE WING AT THE WING ROOT.**

2) Mount the wing to the fuselage. Place a piece of masking tape on the top of each wing 88mm back from the leading edge at the wing root.

3) With the model inverted, place your fingers on the masking tape and carefully lift the plane. This is the point at which your model should balance for your first flights. Later, you may wish to experiment by shifting the balance up to 10mm forward or back to change the flying characteristics. Moving the balance forward may improve the smoothness and arrow-like tracking, but it may then require more speed for take off and make it more difficult to slow down for landing. Moving the balance aft makes the model more agile with a lighter and snappier "feel". In any case, please start at the location we recommend.

\*If possible, first attempt to balance the model by changing the position of the receiver battery and receiver. If you are unable to obtain good balance by doing so, then it will be necessary to add weight to the nose or tail to achieve the proper balance point.



With the wings attached to the fuselage, all parts of the model installed ( ready to fly), and empty fuel tanks, hold the model at the marked balance point with the stabilizer level.

Lift the model. If the tail drops when you lift, the model is "tail heavy" and you must add weight\* to the nose. If the nose drops, it is "nose heavy" and you must add weight\* to the tail to balance.

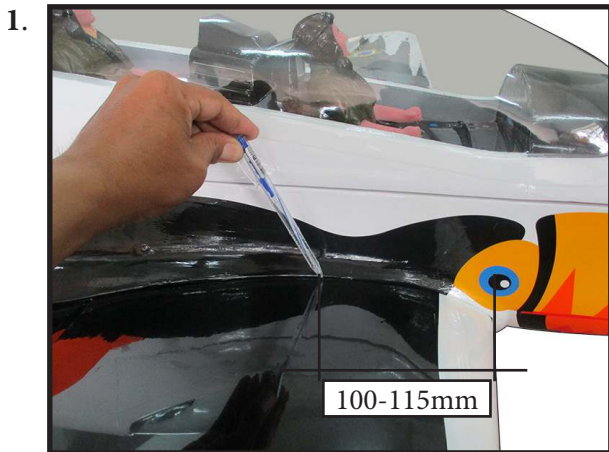

**CONTROL THROWS**

<b>Ailerons:</b>	<b>Rudder:</b>
High Rate :	High Rate :
Up : 20 mm	Right : 40 mm
Down : 20 mm	Left : 40 mm
Low Rate :	Low Rate :
Up : 15 mm	Right : 25 mm
Down : 15 mm	Left : 25 mm

<b>Elevator:</b>	<b>Flap:</b>
High Rate :	Mid : 30mm
Up : 20 mm	
Down : 20 mm	
Low Rate :	
Up : 15 mm	
Down : 15 mm	

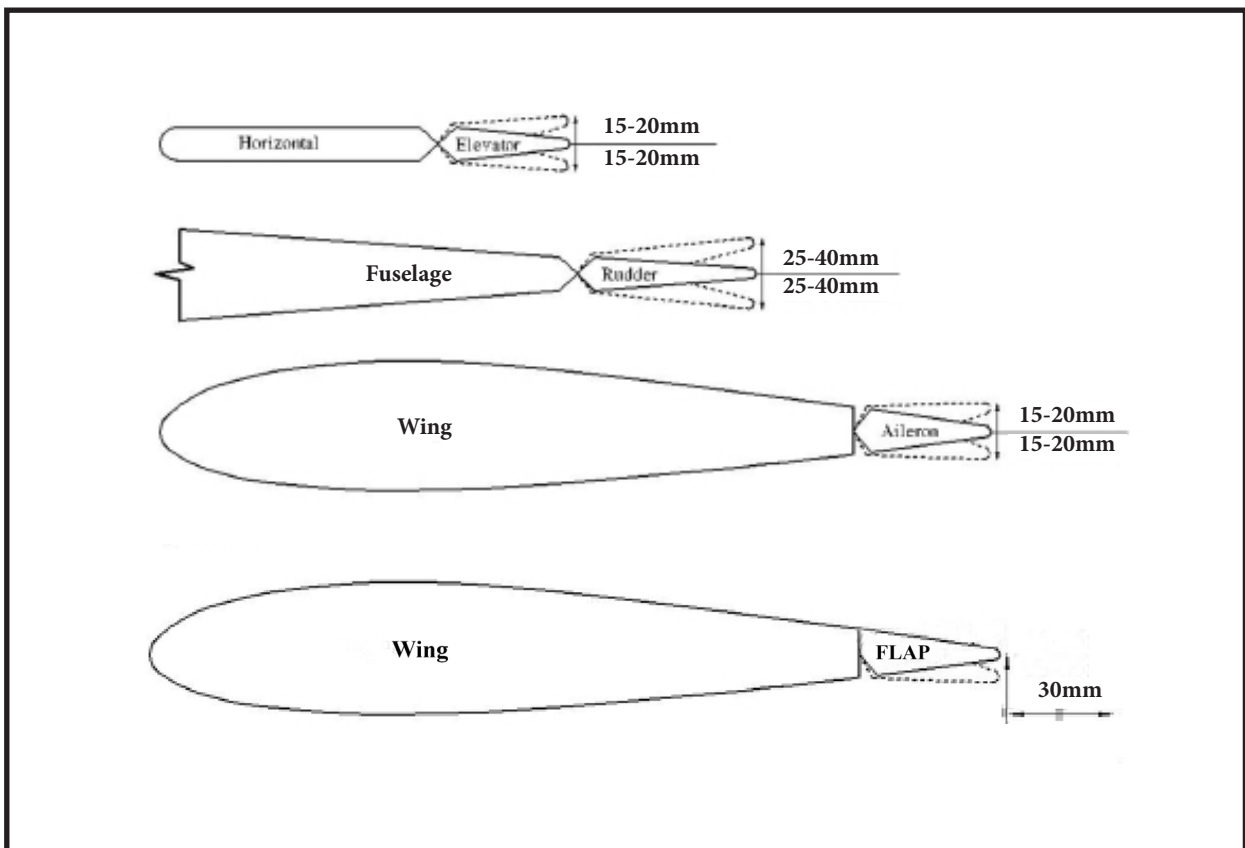

## FLIGHT PREPARATION

Check the operation and direction of the elevator, rudder, ailerons and throttle.

□ A) Plug in your radio system per the manufacturer's instructions and turn everything on.

□ B) Check the elevator first. Pull back on the elevator stick. The elevator halves should move up. If it they do not, flip the servo reversing switch on your transmitter to change the direction.

□ C) Check the rudder. Looking from behind the airplane, move the rudder stick to the right. The rudder should move to the right. If it does not, flip the servo reversing switch on your transmitter to change the direction.

□ D) Check the throttle. Moving the throttle stick forward should open the carburetor barrel. If it does not, flip the servo reversing switch on your transmitter to change the direction.

□ E) From behind the airplane, look at the aileron on the right wing half. Move the aileron stick to the right. The right aileron should move up and the other aileron should move down. If it does not, flip the servo reversing switch on your transmitter to change the direction.

## PREFLIGHT CHECK

□ 1) Completely charge your transmitter and receiver batteries before your first day of flying.

□ 2) Check every bolt and every glue joint in the **Embraer EMB-312 Tucano T-27 Brazilian Air Force 85" span 30-38cc** to ensure that everything is tight and well bonded.

□ 3) Double check the balance of the airplane. Do this with the fuel tank empty.

□ 4) Check the control surfaces. All should move in the correct direction and not bind in any way.

□ 5) If your radio transmitter is equipped with dual rate switches double check that they are on the low rate setting for your first few flights.

□ 6) Check to ensure the control surfaces are moving the proper amount for both low and high rate settings.

□ 7) Check the receiver antenna. It should be fully extended and not coiled up inside the fuselage.

□ 8) Properly balance the propeller. An out of balance propeller will cause excessive vibration which could lead to engine and/or airframe failure.

*We wish you many safe and enjoyable flights  
with your Embraer EMB-312 Tucano T-27 Brazilian Air Force 85" span 30-38cc.*

*If you have any queries, or are interested in our products,  
please feel free to contact us*

**Factory :** 12/101A - Hamlet 4 - Le Van Khuong Street - Dong Thanh Ward -  
Hoc Mon District - Ho Chi Minh City - Viet Nam.

**Office :** 62/8 Ngo Tat To Street - Ward 19 - Binh Thanh District - Ho Chi Minh  
City - Viet Nam

**Phone :** 848 - 86622289 or 848- 36018777

**Website :** [www.SeagullModels.com](http://www.SeagullModels.com)

**Email :** [Sales@seagullmodels.com](mailto:Sales@seagullmodels.com)

**Facebook :** [www.facebook.com/SeaGullModels](http://www.facebook.com/SeaGullModels).