



Assembly Manual
ARF and ARFSV



INTRODUCTION

Congratulations on the selection of your new Premier Aircraft Mamba 70cc. Designed by Quique Somenzini, Flex Innovations co-founder and world aerobatic champion, this airplane is designed to excel in both precision and 3D aerobatics. Strict attention to structural and aerodynamic design details make the Mamba a very special airplane that's sure to give you a lot of satisfaction.

Flex Innovations, Inc. and Premier Aircraft thank you for your purchase...enjoy it!

USING THIS MANUAL

This manual is divided into sections to make the assembly of the airplane easier to follow. Note the boxes (□) next to each step to help you keep track of the steps that have been completed.

SPECIAL LANGUAGE DEFINITIONS

The following terms are used throughout the product literature to indicate various levels of potential harm when operating the product.

- NOTICE:** Procedures, which if not properly followed, create a possibility of physical property damage AND a little or no possibility of injury.
- CAUTION:** Procedures, which if not properly followed, create a probability of physical property damage AND a possibility of serious injury.
- WARNING:** Procedures, which if not properly followed, create the probability of property damage, collateral damage, and serious injury OR create a high probability of serious injury.

ATTENTION

Read the ENTIRE instruction manual to become familiar with the features of the product before operating. Failure to assemble or operate the product correctly can result in damage to the product, personal property, and cause serious or fatal injury.

All instructions, warranties and other collateral documents are subject to change at the sole discretion of Flex Innovations, Inc. For up-to-date product literature, please visit our website at www.flexinnovations.com and click on the support tab for this product.

⚠ WARNING

This product is not intended for use by children under 14 years without direct adult supervision.

IMPORTANT INFORMATION REGARDING WARRANTY

Please read our Warranty and Liability section before building this product. If you as the Purchaser or user are not prepared to accept the liability associated with the use of this product, you are advised to return this product immediately in new and unused condition to the place of purchase

SAFETY WARNINGS AND PRECAUTIONS

Protect yourself and others by following these basic safety guidelines.

1. This manual contains instructions for safety, operation and maintenance. It is essential to read and follow all the instructions and warnings in the manual, prior to assembly, setup or use, in order to operate correctly and avoid damage or serious injury.
2. In some cases, the written instructions may differ slightly from the photos. In those instances, the written instructions should be considered correct.
3. This model is not a toy, rather it is a sophisticated hobby product and must be operated with caution and common sense. This product requires some basic mechanical ability. Failure to operate this product in a safe and responsible manner could result in injury, or damage to the product, or other property.
4. This model must be assembled according to these instructions. Do not alter or modify the model outside of these instructions provided by Flex Innovations, Inc, as doing so may render it unsafe and/or unflyable. You must take time to build straight, true and strong. It is your responsibility to ensure the air worthiness of this product.
5. Use only compatible, appropriate components for the final assembly of this model. Ensure that the radio system is in functional condition, that the engine is appropriately sized for the model, and that all other components are appropriate for use in this model as specified in this instruction manual. All components must be installed correctly such that they operate correctly both on the ground and in the air.
6. Inspect and check operation of the model and all its components before every flight.
7. If you are not an experienced pilot, or have not flown a high-performance model before, it is recommended that you seek assistance from an experienced pilot in your R/C club for your first flights. If you're not a member of a club, the Academy of Model Aeronautics (AMA) has information about clubs in your area whose membership includes experienced pilots.
8. Keep the propeller area clear from such items as loose clothing, jewelry, long hair, or tools, as they can become entangled. Keep your hands and body parts away from the propeller as injury can occur.

TABLE OF CONTENTS

Introduction	1	Vertical/Rudder/Tail Wheel Installation	16-19
Using this Manual	1	Rudder/Elevator Final Linkage Installation	19
Special Language Definitions	1	Landing Gear Installation	20-21
Warranty Notice	1	Fuel Tank Assembly	21-23
Safety Warnings and Precautions	1	Engine/Throttle Servo Installation	21-28
Kit Contents	2	Ignition Installation	28-29
Specifications	2	Exhaust Installation	29-31
Completion Items	2	Fuel Tank Installation	31-32
Recommended Completion Items	3	Cowling Installation	33
Replacement Parts Listing	3	Center Section Installation	34-35
Hangar 9 UltraCote/Oracover Colors	3	Radio Gear/Aura 8 Installation	35-36
Required Tools	3	Shark Teeth Installation	37
Required Adhesives	3	Field Assembly	38
Hardware Legend	3	Center of Gravity	39
Assembly Symbol Legend	4	Decal Installation	40
Before Starting Assembly	4	Aura 8 Setup	41
Aileron and Control Horn Installation	4-6	Radio Setup/Range Test/Before First Flight	42
Interplane Strut Block Installation	6-7	Replacement/Optional Parts	43
Aileron Servo/Linkage Installation	7-8	Limited Warranty	44
Elevator/Rudder Servo Installation	11-12	AMA Safety Code	45
Elevator/Rudder Control Horn Installation	12-13	Building and Flying Notes	46-47
Horizontal Stab/Elevator Installation	14-15		

KIT CONTENTS

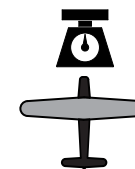
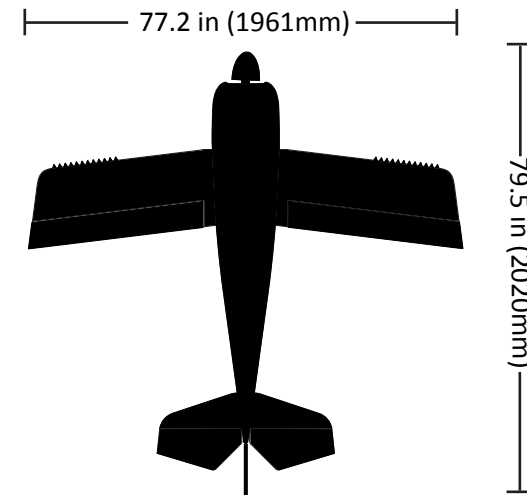

19.0 lb (8.61kg)
*weight may vary due to production tolerances and gear selection.
 2070 sq. in (133.5 sq. dm.)

RECOMMENDED COMPLETION ITEMS



6+ channel transmitter with adjustable dual rates/mixing



Desert Aircraft DA70
 50-70cc Gasoline (Petrol) Engine



Falcon Carbon Fiber 24x9
 See your engine manufacturer's manual for recommendations on your particular engine.



2 x 2000mAh Li-Po (Receiver)
 1 x 2000mAh Li-Po (Ignition)



6 x Potenza DS41611BLHV-H
 1 x Potenza DS19410TGHV
 (6) High Torque Digital Servos
 400+ oz/in (28.8+ kg/cm)



Potenza (FPZC0080)
 Multi-Chemistry LiPo Balancing Charger

NEEDED TO FINISH

In addition to the major electronic components required to finish the airplane, some additional items will be required.

Both Setups

- (1) 50-70cc Gasoline (Petrol) Engine**
- (1) 15mm Standoffs, (set of 4) (for DA70)**
- (2) 2000mAh Li-Po Receiver Batteries**
- (1) Ignition battery (consult your engine manual)**
- (1) Ignition battery voltage regulator (consult your engine manual)**
- (1) 6+ Channel Receiver**
- (1) 6+ Channel Transmitter (w/Dual Rates/Expos)**
- (1) 24x9 Falcon Propeller (consult your engine manual)**
- (1) 5-inch Tru-Turn® Aluminum Spinner**

Setup 1: Pull-Pull Rudder Servo

- (5) 1.25-inch (24mm) heavy-duty aluminum single servo arm*
- (1) 2.5-inch (64mm) heavy-duty aluminum double servo arm*
- (4) 18-inch heavy-duty servo extensions (elevator/ailerons)**
- (2) 3-inch heavy-duty servo extensions (ailerons)**
- (2) 36-inch heavy-duty servo extensions (ailerons)**
- (1) 24-inch heavy-duty servo extension (throttle)**

Setup 2: Push-Pull Rudder Servo

- (6) 1.25-inch (24mm) heavy-duty aluminum single servo arm*
- (4) 18-inch heavy-duty servo extension (elevator/rudder/ailerons)**
- (2) 3-inch heavy-duty servo extensions (ailerons)**
- (2) 36-inch heavy-duty servo extensions (ailerons)**
- (1) 24-inch heavy-duty servo extension (throttle)**

* Included with ARFSV

**Not included with either completion level

HANGAR 9® ULTRACOTE®/ORACOVER® COLORS

In the unfortunate event that your Mamba requires repair after a mishap, please reference the codes below for the appropriate color to repair your covering. UltraCote® will be the most commonly available brand in North and South America, and Oracover® will be most prevalent in Europe and the rest of the world.

Hangar 9® UltraCote®

HANU872	Bright Yellow
HANU881	Silver
HANU874	Black
HANU870	White

Oracover®

33	Cadmium Yellow
91	Silver
71	Black
10	White

REQUIRED TOOLS FOR ASSEMBLY

- | | | |
|-----------------------------------------------------------|--------------------------------------------------------|-----------------------------------------------------|
| <input type="checkbox"/> Toothpicks | <input type="checkbox"/> Drill Bits (sizes) | <input type="checkbox"/> Electric Drill |
| <input type="checkbox"/> Epoxy Brushes/Mixing Cups/Sticks | <input type="checkbox"/> Felt-Tipped Pen | <input type="checkbox"/> Flat File |
| <input type="checkbox"/> Isopropyl Alcohol (91%) | <input type="checkbox"/> Hex Wrench (sizes) | <input type="checkbox"/> Hobby Knife with #11 Blade |
| <input type="checkbox"/> Pliers | <input type="checkbox"/> Light Machine Oil | <input type="checkbox"/> Low-Tack Masking Tape |
| <input type="checkbox"/> Needle-Nosed Pliers | <input type="checkbox"/> Nut Drivers (sizes) | <input type="checkbox"/> Paper Towels |
| <input type="checkbox"/> Petroleum Jelly | <input type="checkbox"/> Phillips Screwdriver (#1, #2) | |
| <input type="checkbox"/> Ruler | <input type="checkbox"/> Tie Wraps (4-inch)* | |
| <input type="checkbox"/> Side Cutters | <input type="checkbox"/> Hook & Loop Straps/Tape | |

REQUIRED ADHESIVES FOR ASSEMBLY

- Thin CA Medium CA 15-minute Epoxy 30-minute Epoxy Blue Thread Lock

HARDWARE IDENTIFICATION LEGEND



Machine Screw



Wood Screw

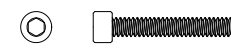

Socket Head Cap Screw



Self Tapping Screw



Flat Washer



Nylon Insert Lock Nut



Hex Nut



Wheel Collar



Ball Link



Rigging Coupler



Quick Connect



Wire Crimp

ASSEMBLY SYMBOL LEGEND



IMPORTANT BEFORE STARTING ASSEMBLY

Organization is key to building a successful, well-built, good-flying model. Please take a few moments to follow these next few steps to ensure you are getting the most out of your Mamba, and ensure that it will be in your stable for a long time to come.

- 1. Remove all parts from their plastic bags, inventory all items and closely examine all of the major airframe components for damage. If any items are missing, or you find damaged components, please contact customer support.
- 2. Use a covering iron with a covering sock on high heat to tighten the covering as necessary, paying special attention to the leading edges of the flying surfaces, hinge lines and stabilizer and wing saddle areas. Apply slight pressure over sheeted areas to thoroughly bond the covering to the wood. Use caution around seams to prevent inadvertently pulling them loose.
- 3. Use thin CA to go over any important glue joints, such as the motor box, firewall, servo mounting rails, and any other pre-assembled joints that may see high stress during flight.
- 4. Gather all required components such as motor and radio equipment that will be used to equip the airplane. Create a new radio program in your transmitter and bind this model program to the receiver that will be used in the airplane.

AILERON HINGES AND AILERON CONTROL HORN INSTALLATION - ARF

Required Components

Main Wings (x4) Ailerons (x4) Aileron Hinges (20)
Control Horns (x8)

Required Adhesives

30-Minute Epoxy (Or other hinge-type glue)

Required Tools/Building Materials

Low-Tack Masking Tape Medium Grit Sand Paper Toothpicks (optional)
Petroleum Jelly Isopropyl Alcohol (91%)
Epoxy Mixing Cups/Sticks Paper Towels

HELPFUL HINT

In order to help prevent scratches on your new model, it is always best to work with the parts on a soft surface, like packing foam or felt.

1.

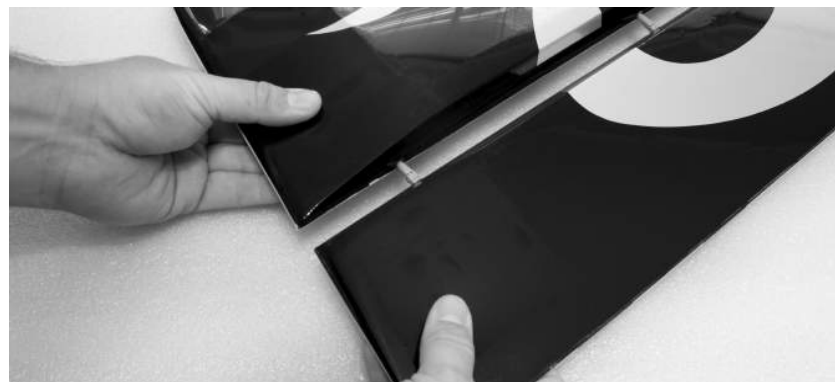

Test fit the hinges into the ailerons, and then the hinges into the wings. Ensure that the hinge pockets line up, and that the hinges move freely.

2.



Prepare the aileron hinges by scuffing the area that will be inserted into the wing or flying surface with medium grit sand paper. Be careful not to remove too much material. Use isopropyl alcohol, and a paper towel to remove any excess debris that remains on the hinges.

□ 3.

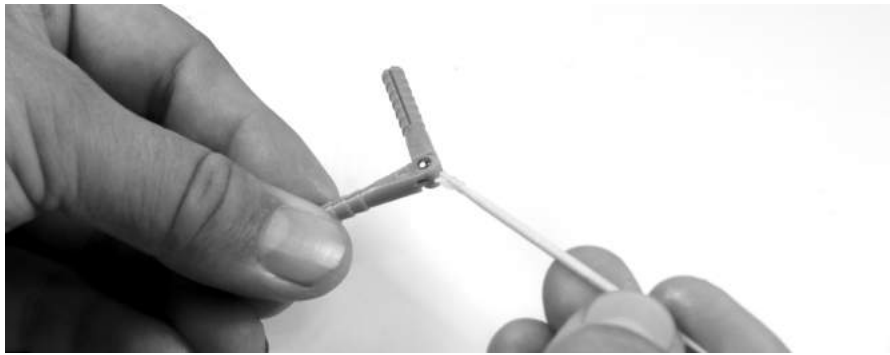

Using a toothpick or cotton swab, apply a small amount of petroleum jelly to the pivot of each hinge. Do not apply petroleum jelly to the entire hinge.

⚠ WARNING

Petroleum jelly prevents glue adhesion. Do not apply petroleum jelly to the surface areas of the hinge that require glue adhesion to the wing or surface.

□ 4.

30
x2

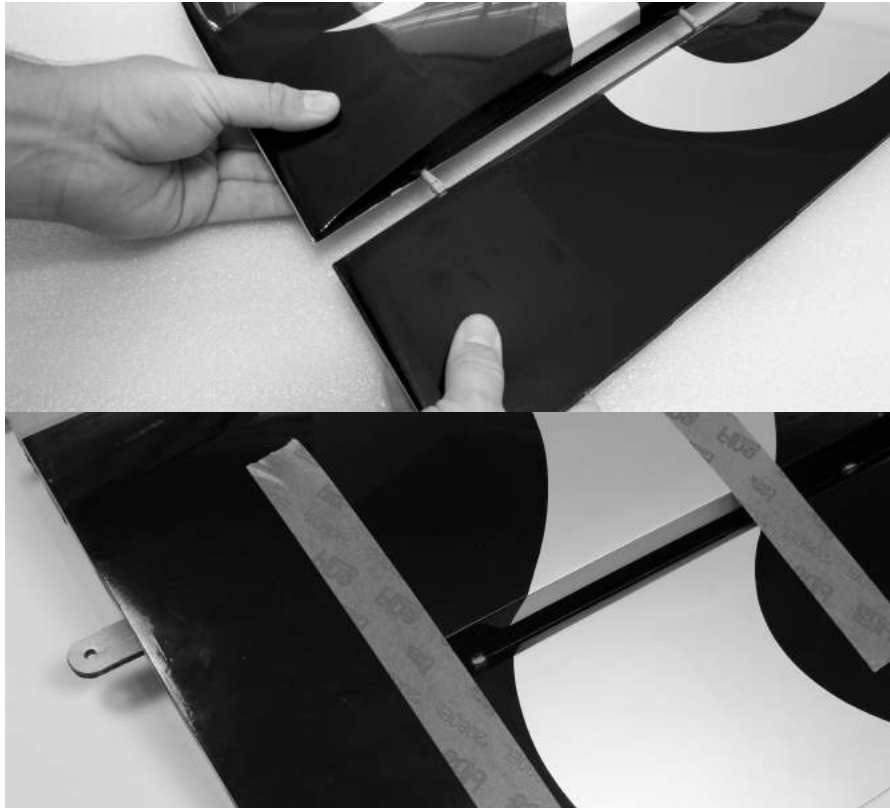

Mix a sufficient amount of 30-minute epoxy in a cup, and with a toothpick, smear epoxy in the hinge pockets of the wing panel and aileron. Slowly and carefully, insert each hinge into the wing panel. Partially remove and reinstall the hinge to ensure that you've completely coated it with glue. Clean up any excess epoxy with isopropyl alcohol, and tape the aileron in place to cure.

□ 5.

x2

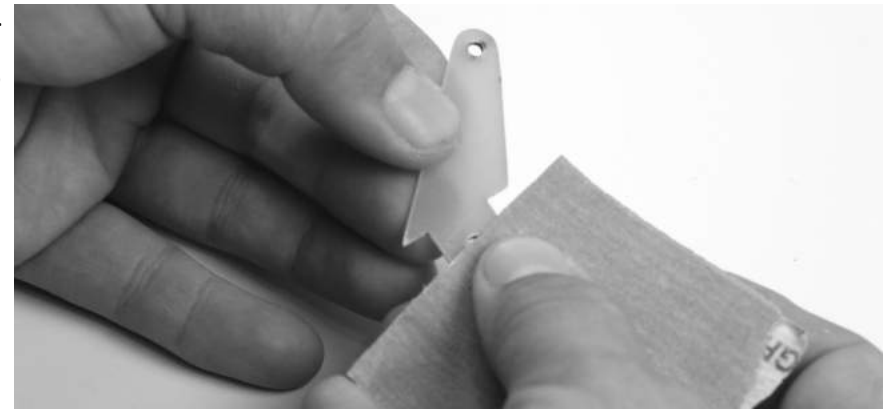

Prepare the aileron control horns by sanding the section that extends into the control surface with medium grit sand paper. Use isopropyl alcohol and a paper towel to remove any excess debris from the control horn.

NOTICE

If not properly scuffed, glue may not adhere to the control horn, resulting in a failure.

□ 6.

x2

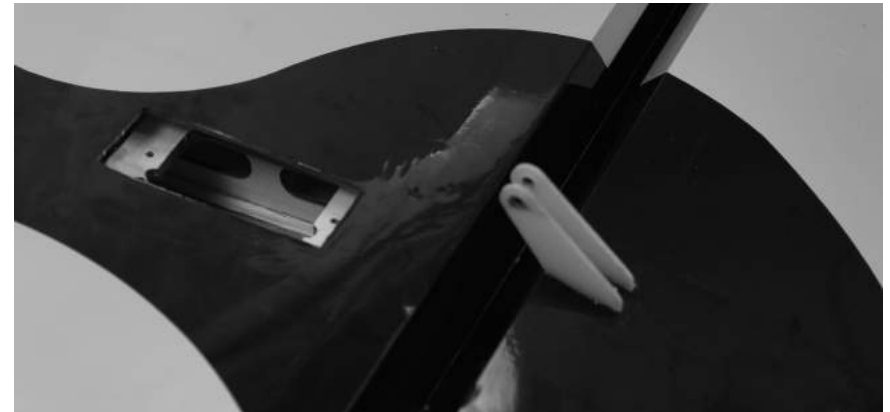

Locate the control horn slots in the ailerons, remove the covering from the slots with a #11 hobby knife. Check the fit of the control horns in the slots of the ailerons. Make any adjustments necessary at this time.

□ 7.

x2



Once satisfied with the fit of the control horns, apply low-tack tape approximately 1/32-inch (1mm) around the control horns. This will help keep epoxy off of the surface of the ailerons. Once the tape has been applied, remove the control horns.

□ 8.

30

x2



Mix a sufficient amount of 30-minute epoxy in a cup, and with a toothpick, apply epoxy in the control horn slots in the aileron. Slowly and carefully, insert each control into the aileron. Partially remove and reinstall the control horn to ensure that you've completely coated it with glue. Before the epoxy has fully cured, remove the tape, and clean up any excess epoxy with a paper towel and isopropyl alcohol.

INTERPLANE STRUT BLOCK INSTALLATION - ARF

Required Components

Main Wing (x4)

Interplane Strut Blocks (4)

Required Adhesives

30-Minute Epoxy

Required Tools/Building Materials

Covering Iron/Trim Iron
Low-Tack Tape

Hobby Knife with #11 Blade
Isopropyl Alcohol

Paper Towels

□ 1.

x2

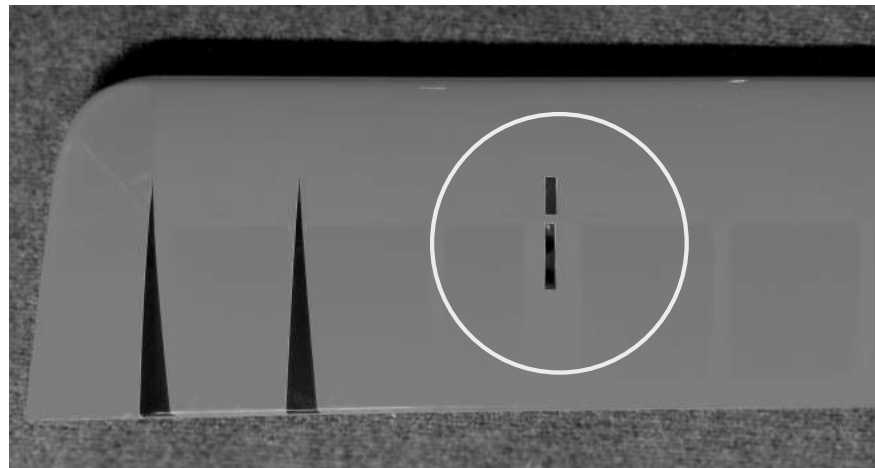

Locate the slots in the wing for the interplane strut block locations. These are located in the top of the bottom wings, and the bottom of the top wings. Carefully cut and remove the covering from this slot, while leaving 1/8-inch (3mm) extra covering over the inside of the slot. Cut the corners at a 45-degree angle, and use a covering or trim iron to seal the covering down into the slot.

□ 2.

x2

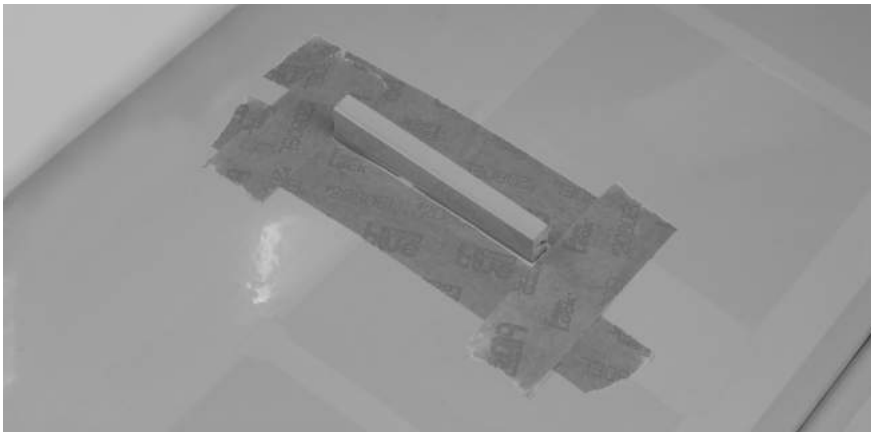

Test fit the blocks into the pockets. Be sure they fit correctly and completely into the pocket. Note that there are different blocks for the top wings, and different blocks for the bottom wings. They will not fit in the opposite wing. Apply low-tack tape approximately 1/32-inch (1mm) away from the edges of the pocket in the wing.

HELPFUL HINT

To confirm proper fitment of the interplane struts and strut blocks, now is a good time to test fit the interplane struts to the blocks. Reference the "Field Assembly" section near the back of this manual for the interplane strut installation guide.

□ 3.

x2



30

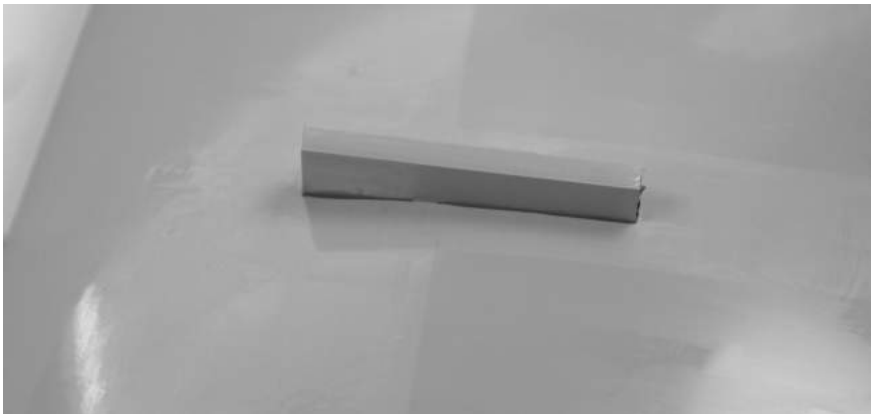

Mix a sufficient amount of 30-minute epoxy in a cup, and with a toothpick, smear epoxy in the strut block pockets of the wing panel. Slowly and carefully, insert each block into the wing panel. Partially remove and reinstall the block to ensure that you've completely coated it with glue. Be sure to firmly seat the block fully into the wing panel. Before the epoxy fully cures, remove the low-tack tape, and clean up any excess epoxy with isopropyl alcohol and a paper towel.

AILERON SERVO AND LINKAGE INSTALLATION - ARF

Required Components

Main Wing (x4)	Aileron Servo (x4)	6-Inch (150mm) Extension (x2)
Aileron Linkage (X4)	Ball Links (X8)	4-40 x 5/8-inch SHCS (X8)
#4 Lock Nut (X8)	#4 Washer (X16)	

Required Adhesives

Thin CA	Blue Thread Lock
---------	------------------

Required Tools/Building Materials

#1 Phillips Screwdriver	Ball Driver: 3/32	Nut Driver: 1/4-inch
Thread or Shrink Tube		

□ 1.

x2



Locate the aileron servo bays in the wings. Use a #11 hobby knife to remove the covering, leaving approximately 1/8-inch (3mm) extra covering over the inside of the pocket. Use a covering or trim iron to seal the covering into the slot. Prepare the aileron servos by installing the rubber grommets and brass eyelets. Secure a 6-inch (120mm) extension to the bottom wing servos. No extension is required for the top wing servos.

□ 2.

x2

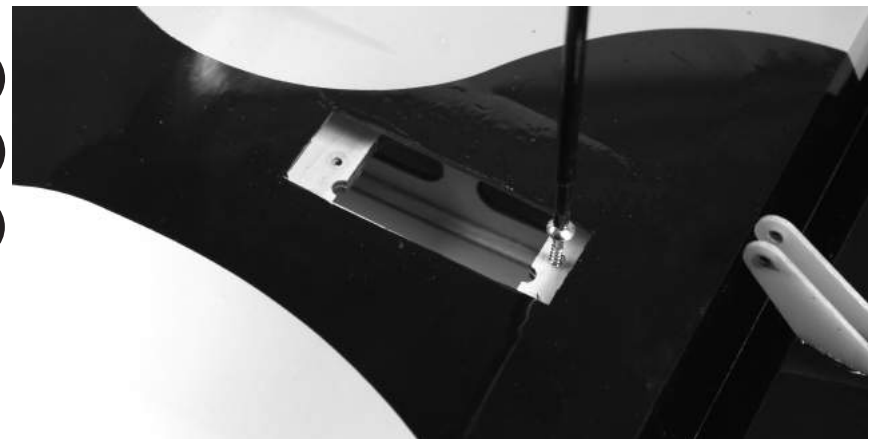

Use a #1 Phillips screwdriver to thread a servo mounting screw into each of the pre-cut holes in the servo mounting rails in the wing. Remove the screw, and apply a small amount of thin CA to each of the holes to harden the threads cut by the screw. Let the CA fully cure before moving forward.

3.

x2

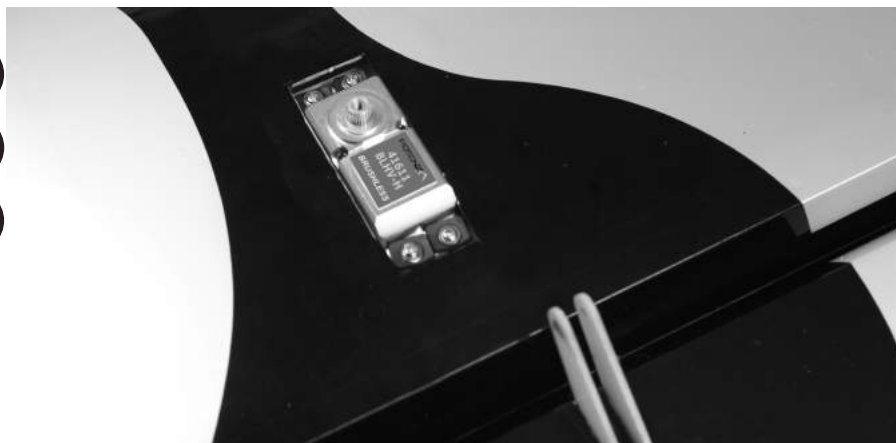

Insert the aileron servo into the servo bay with the output shaft towards the leading edge of the wing. Be sure to route the servo lead out of the wing before mounting the servo. Mount the servo to the wing using the screws provided with your servo.

4.

x2

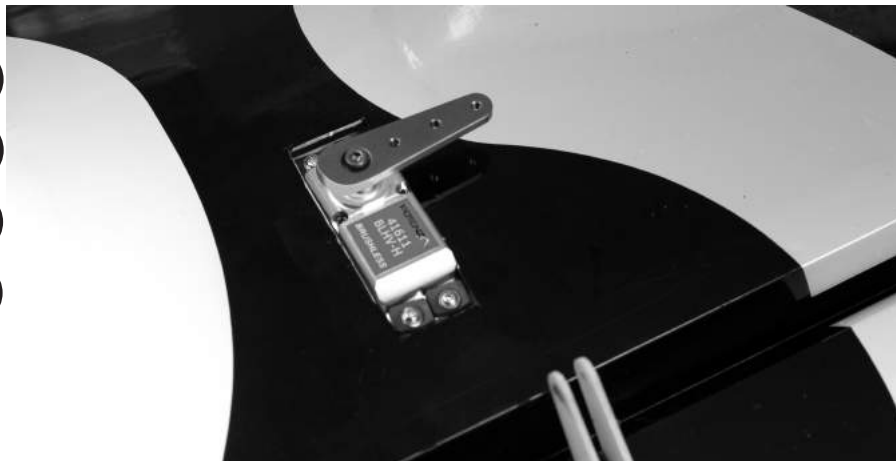

Center the servo using your radio system. Install a 1-1/4-inch (32mm) servo arm onto the servo. Apply a very small drop of blue thread lock onto the servo arm screw, and fully tighten the screw. Be sure to avoid getting thread lock compound into the servo gears.

5.

x2



Ball Link (2)

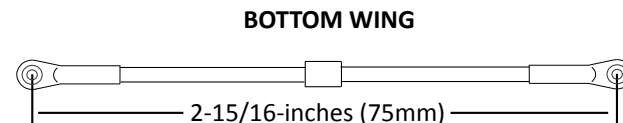
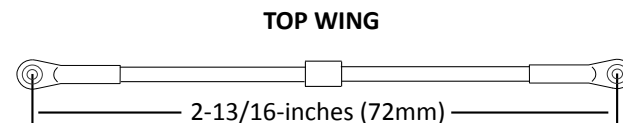

**Note: Drawing not to scale

Using a pushrod of 2-inch (51mm) length, assemble the aileron linkages so that the total length from center of ball to center of ball is approximately 2-13/16-inches (72mm) for the top wings, and 2-15/16-inches (75mm) for the bottom wings. Final length will be adjusted when centering the control surface. Note that the ends of the aileron linkages use opposite direction threads.

6.

x2



4-40x5/8 (2)



#4 (2)



#4 (4)

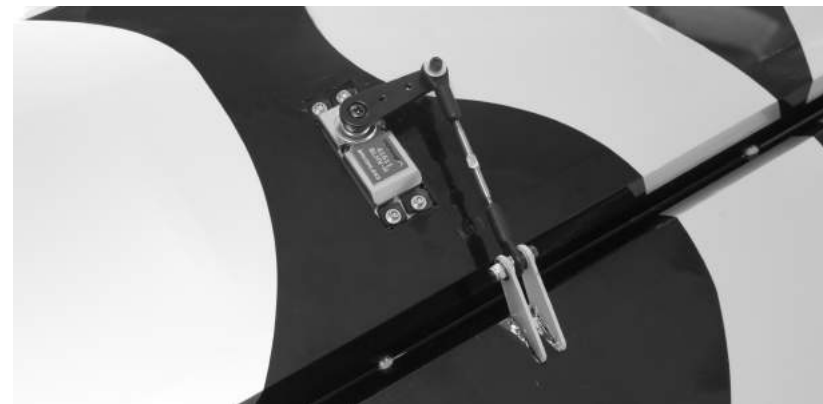

Attach the linkage to the servo arm. The order of components starting AWAY from the wing is as follows:

- 4-40x5/8-inch Socket Head Cap Screw
- #4 Washer
- Ball Link
- #4 Washer
- Servo Arm
- #4 Lock Nut

With the radio powered on, and the servo centered with the arm parallel to the hinge line, adjust the linkage length so that the control surface is centered. Attach the linkage to the control horn in the following order:

- 4-40x5/8-inch Socket Head Cap Screw
- #4 Washer
- Control Horn
- Ball Link
- Control Horn
- #4 Washer

ELEVATOR/RUDDER SERVO INSTALLATION - ARF

Required Components

Fuselage	Elevator Servo(s)*	Rudder Servo
Elevator Linkage(s)*	Rudder Linkage*	Rigging Couplers*
#4 Lock Nuts*	#4 Washers*	4-40x5/8-inch SHCS*
18-Inch (460mm) Extension(s)*	Wire Crimps*	Pull-Pull Cable*

Required Adhesives

Thin CA	Blue Thread Locker
---------	--------------------

Required Tools/Building Materials

#1 Phillips Screwdriver	Ball Driver: 3/32	Nut Driver: 1/4-inch
Thread or Shrink Tube	Needle-Nosed Pliers	

There are three options for the elevator and rudder servo setup in this model:

- A. Pull-Pull Rudder with 1 elevator servo (recommended)
- B. Pull-Pull Rudder with 2 elevator servos
- C. Push-Pull Rudder with 1 elevator servo

*Total number of components required will depend on your particular setup.

NOTICE

Due to the variability of the servo locations, different methods of setup may cause the center of gravity to vary significantly. It is your responsibility to ensure the aircraft balances at the proper center of gravity location prior to flying the model.

□ 1A.



Locate the elevator servo pocket on the left side (if viewed from the rear) of the fuselage, below the stabilizer cutout. Remove the covering from this pocket, leaving approximately 1/8-inch (3mm) excess covering inside the slot. Use a covering or trim iron to seal the excess into the pocket.

□ 2A.



Follow the same steps for installing the aileron servo to install the elevator servo. Secure an 18-inch (460mm) extension to the servo. Route the extension to the front of the fuselage, and install the elevator servo with the output shaft facing the **NOSE** of the aircraft.

□ 3A.



Power on your radio system and center the elevator servo. With the servo on and centered, install a 1 1/4-inch (32mm) servo arm to the servo with the arm towards the horizontal stabilizer slot.

□ 4A.

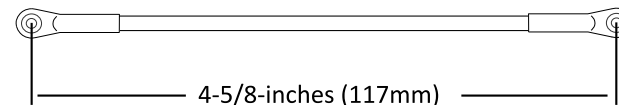
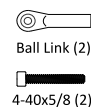

**Note: Drawing not to scale



#4 (2)



#4 (4)

Assemble the elevator linkage in the same manner as the aileron linkage using a 3-1/2-inch (89mm) linkage. The length of the linkage from center of link to center of link should be approximately 4-5/8-inches (117mm). Attach the linkage to the servo arm using the same order of hardware as the aileron linkages. Note that the ends of the elevator linkage(s) have opposite direction threads. Reference page 8 for the proper order of hardware.

Tape the control horn side of the linkage to the fuselage with low-tack tape. This will keep the linkage out of the way for the following steps.

□ 5A.

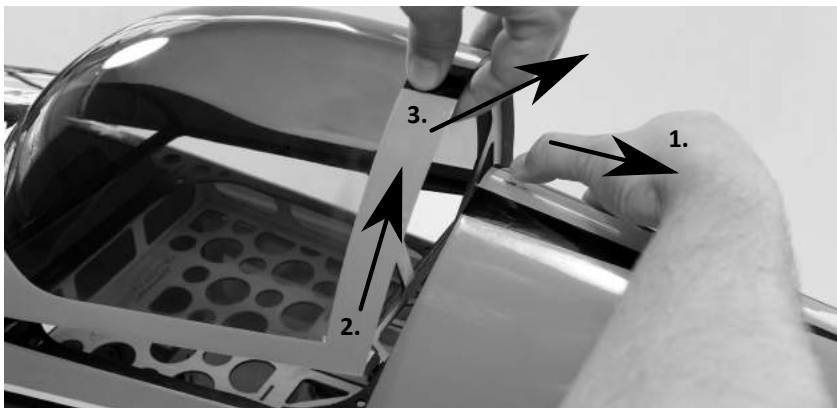

Remove the canopy from the fuselage by pulling back on the latch, lifting the canopy in the rear, and sliding the canopy towards the rear as you lift it away from the fuselage.

□ 6A.



Install the rudder servo in the tray under the canopy area of the fuselage, following the same procedure as the aileron servo installation section. If using this servo location for the rudder, no servo extension is needed. The servo should be installed with the output shaft towards the front of the aircraft.

□ 7A.



Power on your radio system and center the rudder servo. With the servo powered on and centered, install a 2-1/2-inch (64mm) double servo arm onto the servo. Be sure the arm is perpendicular to the servo case.

□ 8A.



Ball Link (1)



Rigging Coupler (1)



Using pliers, thread a rigging coupler approximately halfway into a ball link.

HELPFUL HINT

You can take a ruler and felt-tipped marker to mark the center of the threads on the rigging coupler. Once the end of the ball link reaches the mark you made on the threads, you know the rigging coupler has sufficient thread depth into the ball link.

□ 9A.



Wire Crimp (1)



Take a section of pull-pull cable, and route it through a wire crimp. Then route the cable through the rigging coupler, and back through the crimp. For extra security, you can loop the cable around the crimp a final time. Slide the crimp tight against the coupler, and use a crimping tool to permanently attach the cable.

□ 10A.



Locate the pull-pull wire exit holes in the rear of the fuselage. Use a hobby knife with a number 11 blade to remove the covering from this hole.

□ 11A.



4-40x5/8 (2)



#4 (2)



#4 (4)

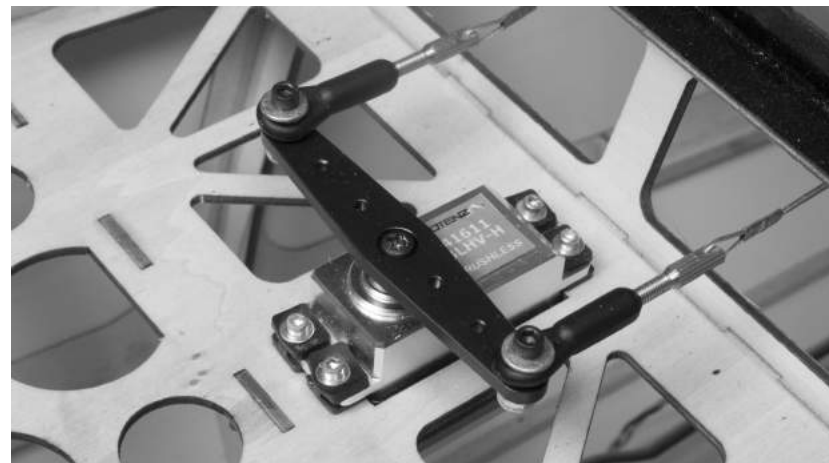

Install the ball links with pull pull wire onto the rudder servo arm. Use the same order of hardware as with the ailerons (reference page 7).

□ 12A.

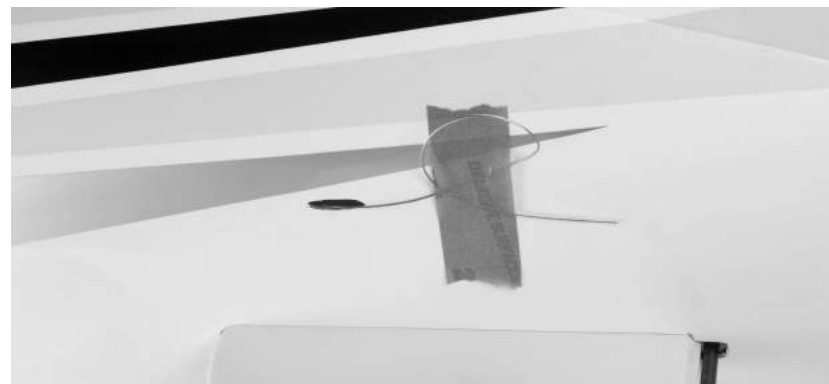

Route the pull pull cable through the fuselage and out the exit holes located in step 10A. Be sure to route the cables so that they do not tangle or cross. The cables should route straight from the servo arms to the exits of the fuselage. Tape the cables to the side of the fuselage using low-tack tape for the following steps.

Dual Elevator Servos with Rudder Pull-Pull

- 1B. Repeat steps 1A-4A for the right side of the fuselage.

Standard Elevator Servo with Tail-Mounted Rudder Servo

- 1C. Follow steps 1A-4A for the elevator servo. Repeat steps 1A-4A for the opposite side of the fuselage. See details below:
- 2C.



Power on your radio system and center the rudder servo. With the servo on and centered, install a 1 1/4-inch (32mm) servo arm onto the servo with the arm **towards** the horizontal stabilizer slot.

ELEVATOR/RUDDER CONTROL HORN INSTALLATION - ARF

Required Components

Rudder Elevator (X2)* Rudder Control Horns
Elevator Control Horns*

Required Adhesives

30-Minute Epoxy

Required Tools/Building Materials

Low-Tack Tape Isopropyl Alcohol Paper Towels

*Number of parts required will vary depend on elevator setup type (dual versus single elevator)

- 1.



x2



Locate the elevator halves. If using only a single elevator servo, only the left elevator (if viewed from rear of airplane) is required. Remove covering from the control horn slots in the bottom of the elevator(s).

- 2.



x2

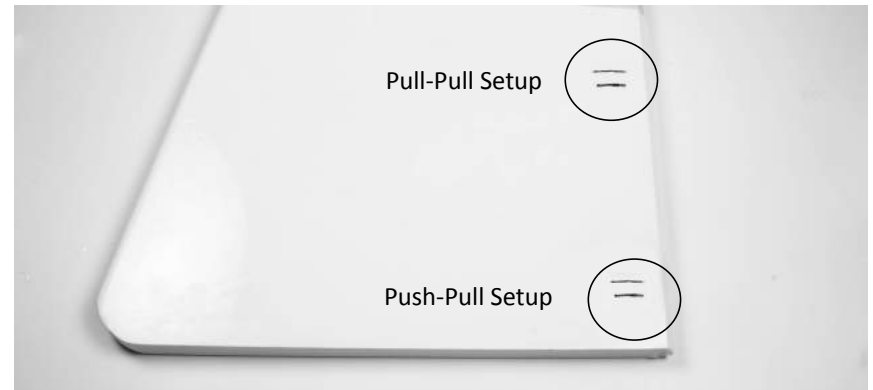

Locate the rudder. There are two control horn locations for the rudder depending on your setup. If using the pull-pull rudder setup, remove the covering from **BOTH** sides of the upper control horn slots. If using a push-pull rudder setup, remove covering **ONLY** from the **RIGHT SIDE** of the lower control horn slots.

□ 3.



*If using a tail-mounted rudder servo setup, use the second set of elevator control horns in place of the pull-pull rudder control horns.

□ 4.



x2

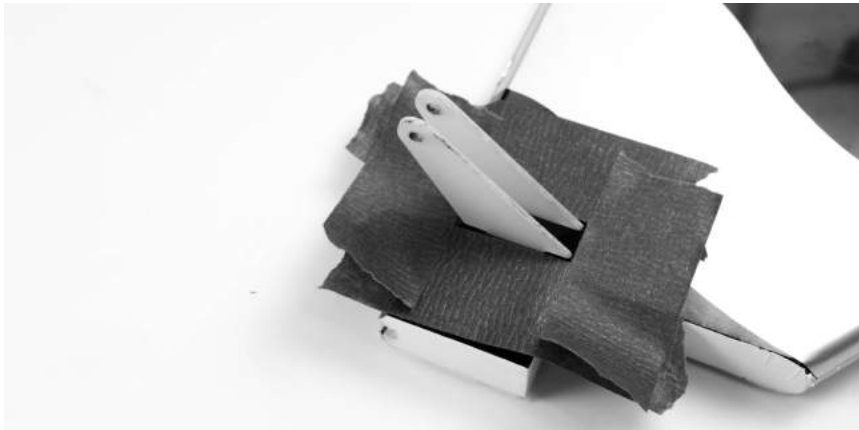

Test fit the control horns in their corresponding slots. Make any adjustments necessary to the slots at this time. Once satisfied with the fit of the control horns, apply low-tack tape approximately 1/32-inch (1mm) away from the control horns. If using a pull-pull rudder setup, but sure to do this to both sides of the rudder. After applying low-tack tape, remove the control horns from the slots.

□ 5.

x2

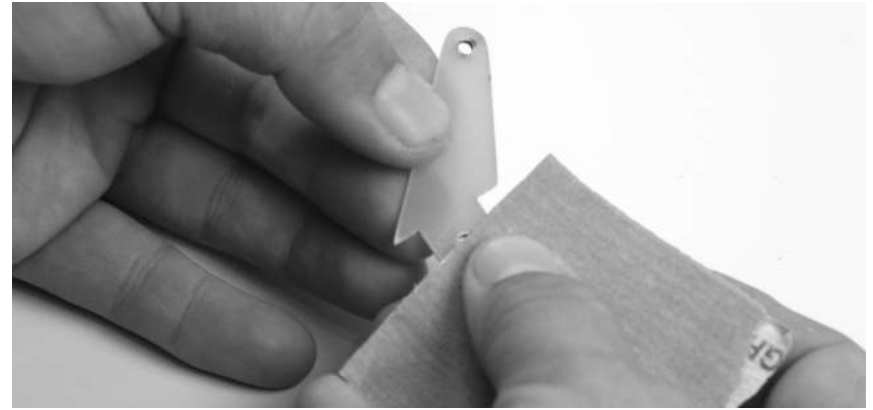

Prepare the control horns by sanding the section that extends into the control surface with medium grit sand paper. Use isopropyl alcohol and a paper towel to remove any excess debris from the control horn.

NOTICE

If not properly scuffed, glue may not adhere to the control horn, resulting in a failure.

□ 6.

30

x2



Mix a sufficient amount of 30-minute epoxy in a cup, and with a toothpick, apply epoxy in the control horn slots. Slowly and carefully, insert each control horn into the surfaces. Partially remove and reinstall the control horn to ensure that you've completely coated it with glue. Before the epoxy has fully cured, remove the tape, and clean up any excess epoxy with a paper towel and isopropyl alcohol.

HORIZONTAL STABILIZER & ELEVATOR INSTALLATION - ARF & ARFSV

Required Components

Fuselage (canopy removed)	Horizontal Stabilizer	Elevator Halves (L&R)
Elevator Joiner Wire*	Lower Wing Bolts (optional)	Lower Wings (L&R)
Pin-Hinges (X6)	Lower Wing Tube	

Required Adhesives

30-Minute Epoxy

Required Tools/Building Materials

Ruler & Tape Measure	Isopropyl Alcohol	Paper Towels
Epoxy Mixing Cups/Sticks	Low-Tack Masking Tape	Toothpicks (optional)

***If using dual elevator servos, the elevator joiner wire is not used.**

□ 1.



Insert the elevator joiner wire* into the fuselage, and then slide the horizontal stabilizer through the saddle, using the covering cutouts as reference lines. Be sure to insert the horizontal stabilizer with the yellow side towards the top (canopy side) of the airplane. Insert the lower wing tube into the fuselage and slide the left and right lower wings onto the tube at this time, ensuring that they are fully seated. You can choose to install the wing bolts at this time. Reference the "field assembly" section near the back of this manual.

□ 2.

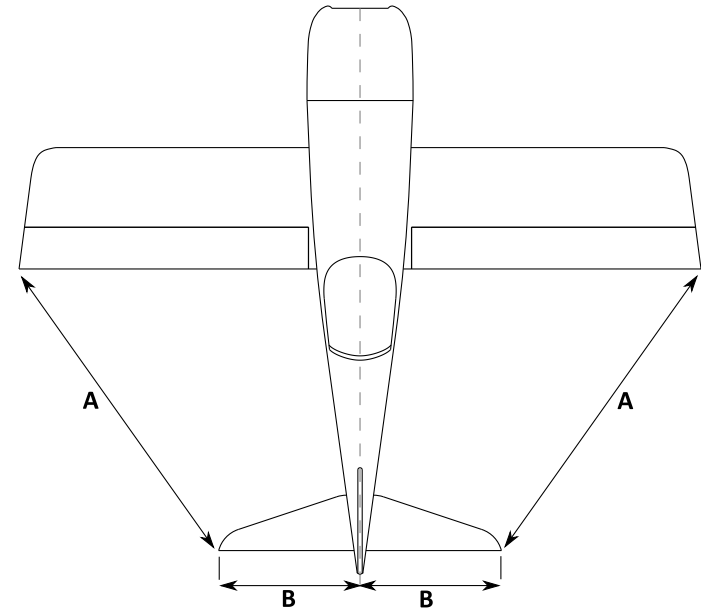

Center the horizontal stabilizer in the fuselage so that the trailing edge (B) is equidistant on the left and right sides. Adjust the tips of the stabilizer fore and aft to achieve an equal distance between corresponding points on the stabilizer tips and wing tips on both sides of the fuselage.

□ 3.

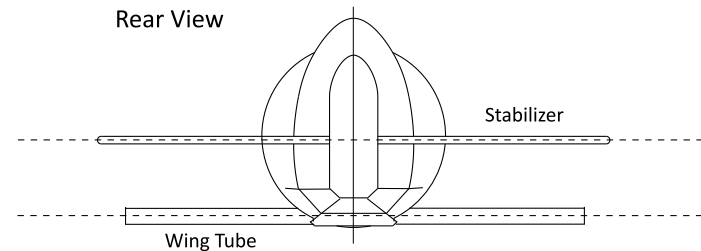

Remove the wing panels from the airplane, but leave the lower wing tube in the fuselage. Stand back approximately 10 feet (3 meters) from the rear of the airplane and carefully sight down the fuselage to level the horizontal stabilizer with the lower wing tube. It may be necessary to fabricate some shims from thin balsa sheet to correct a stabilizer that is out of level.

□ 4.



Once satisfied with the alignment of the stabilizer, carefully tack it into place with thin CA, then wick CA around the entire upper surface of the horizontal stabilizer. Wait a few moments for the CA to cure, then carefully roll the airplane inverted to glue the underside of the stabilizer.

□ 5.



Test fit the elevator halves by sliding each elevator half onto the horizontal stabilizer, indexing the joiner wire* into the slots in the elevator. Ensure that the elevator halves are properly aligned with each other at the trailing edge with the elevators centered with the stabilizer. Correct any misalignment by carefully bending the joiner wire. Do not adjust the slots in the elevator halves.

*joiner wire is not used for a dual elevator servo setup.

□ 6.

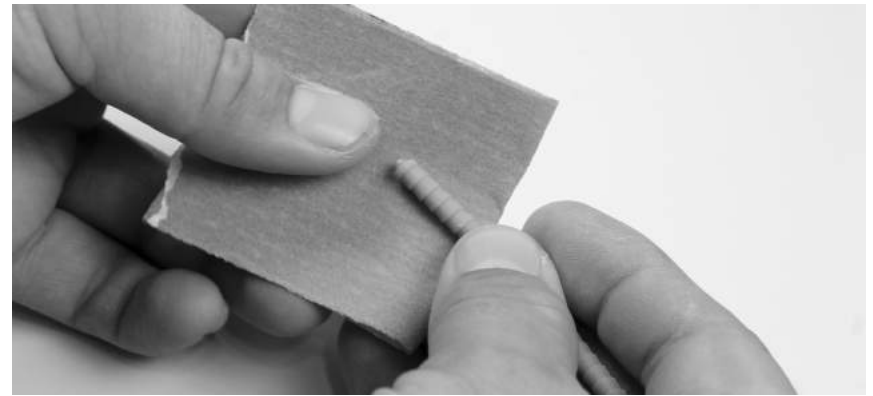

Prepare the hinges and elevator joiner wire (if applicable) by sanding them with medium grit sand paper. Remove any excess debris by cleaning them with isopropyl alcohol and a paper towel. Apply petroleum jelly to the hinge points like completed when hinging the ailerons.

□ 7.

30



Mix a sufficient amount of 30-minute epoxy in a cup, and with a toothpick, smear epoxy in the hinge and joiner pockets of the stabilizer and elevator. Slowly and carefully, insert each hinge into the stabilizer and elevator. Partially remove and reinstall the hinge or joiner to ensure that you've completely coated them with glue. Be sure the hinges are oriented so that the elevators can move properly. Clean up any excess epoxy with isopropyl alcohol, and tape the elevator in place to cure.

VERTICAL STABILIZER, RUDDER & TAILWHEEL INSTALLATION ARF & ARFSV

Required Components

Fuselage Assembly	Vertical Stabilizer	Rudder
Flat Hinges (X4)	Tailwheel Wire	M3 Lock Collar w/Screw (X2)
Tailwheel	Tailwheel Bracket	M3x10 Wood Screw (2)
M3 Washer (X2)		

Required Adhesives

30-Minute Epoxy	Thin CA
-----------------	---------

Required Tools/Building Materials

Epoxy Mixing Cups/Sticks	Isopropyl Alcohol (91%)	Paper Towels
Low-Tack Masking Tape	Ruler	Toothpicks (optional)
Flat File	Petroleum Jelly	Light Oil
Drill Bits: 1/16-inch (1.5mm)	Electric Drill	

□ 1.



Rear View

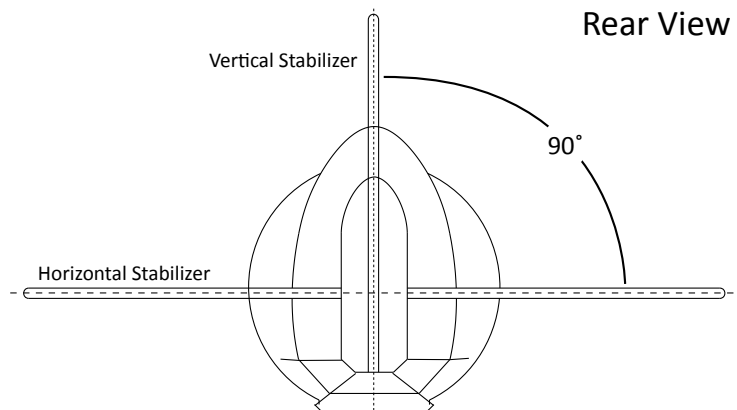

Test fit the vertical stabilizer into the slot in the fuselage. Check that the vertical fin fits perpendicular to the horizontal stabilizer. If any adjustment is required, remove a small amount of material from the fuselage. Once satisfied with the fit of the vertical stabilizer, apply a strip of low-tack tape on each side of the vertical fin to mark the fuselage location.

□ 2.



Use a hobby knife with a #11 blade to cut the covering approximately 1/8-inch (3mm) from the edge of the tape. Stop short of the hinge line. Reference the above photo.

□ 3.



Re-insert the vertical fin into the fuselage slot. Double check alignment with the horizontal stabilizer. Once satisfied with the alignment, use thin CA to tack the vertical fin in place. With the fuselage rolled to a 45-degree angle, apply thin CA to the corner of the fuse and vertical fin to secure it in place. Wait a few moments, and repeat for the other side of the vertical fin. Be sure to get a good amount of glue on the back section of the fin that extends down the back side of the fuselage. 30-minute epoxy may also be substituted for thin CA in this step.

□ 4.



Prepare the tailwheel wire by scuffing the "L" shape bend side of the wire with medium grit sand paper. This is done to promote glue adhesion when hinging the rudder.

□ 5.



The tail wheel bracket has 3 holes. 2 are slightly smaller than the other. Assemble the tail wheel wire and bracket by sliding the bracket over the "L" bent side of the wire, using the larger of the 3 holes in the bracket. This larger hole is just large enough to fit the wire through it. It may be snug, but do not drill out this hole, as it is important to keep this tolerance tight for proper longevity of your bracket.

□ 6.



Use a file to make two small flat spots on the inside and outside of the tail wheel wire for the lock collar set screws.

□ 7.



Finish the tail wheel bracket assembly by sliding a M3 lock collar onto the tail wheel axle with the flange facing the center of the axle. Apply a drop of light oil on the axle, and slide the wheel onto the axle. Install another M3 lock collar, with the flange facing the wheel. Apply blue thread lock to the set screws, tighten them into the lock collars, and on to the flat spots created in the previous steps. Be sure the tail wheel rotates freely.

□ 8.



With the hatches removed from the airplane, and the fuselage inverted on your work space, use a felt-tipped pen to mark a short center line for the tail wheel bracket down the aft end of the fuselage.

9.



Using the marks from the previous step, align the tail wheel bracket along this center line. Mark the two hole locations with a felt-tipped pen, and remove the bracket.

10.



Use a drill and a 1/16-inch drill bit to drill holes at the two marked locations for the tail wheel bracket screws. Thread an M3x10 wood screw into the holes to cut threads in the wood. Remove the screw, and apply a small amount of thin CA to the holes to harden the threads. Once the CA has cured, install the tail wheel bracket with two M3x10 wood screws and two M3 washers. Isopropyl alcohol and a paper towel will remove the pen marks from the covering.

11.



Test fit the rudder hinges and tail wheel wire in the rudder and vertical fin. Make sure all of the hinge slots line up, and that the rudder can move freely. Adjust as needed. Once satisfied with the fit, remove the rudder and the hinges from the aircraft.

12.

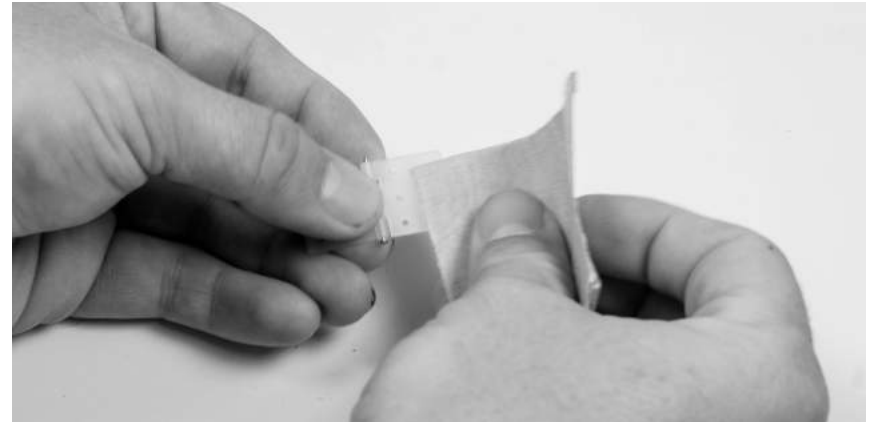

Use medium grit sandpaper to prepare the hinges for installation. Remove any excess debris with a paper towel and isopropyl alcohol. Apply petroleum jelly to the hinge points at this time. This can be applied in the same manner that was used for the elevator and aileron hinges.

WARNING

Petroleum jelly prevents glue adhesion. Do not apply petroleum jelly to the surface areas of the hinge that require glue adhesion to the wing or surface.

□ 12.

30



Mix a sufficient amount of 30-minute epoxy in a cup, and with a toothpick, apply epoxy in the rudder hinge and tail wheel slots. Slowly and carefully, insert each hinge into the slots. Partially remove and re-install the hinges and tail wheel wire to ensure that you've completely coated it with glue. Before the epoxy has fully cured, tape the rudder to the vertical stabilizer, and clean up any excess epoxy with a paper towel and isopropyl alcohol.

RUDDER AND ELEVATOR LINKAGE FINAL ASSEMBLY - ARF & ARFSV

Required Components

Fuselage	#4 Washer*	4-40 x 5/8 Screw*
#4 Lock Nut*	Ball Link*	Rigging Coupler*

Required Tools/Building Materials

Ball Driver: 3/32-inch	Nut Driver: 1/4-inch	Crimping Tool*
------------------------	----------------------	----------------

*Number of components required may vary depending on your particular tail servo setup.

□ 1.



Ball Link (1)



Rigging Coupler (1)



If using a pull-pull rudder servo setup, thread a rigging coupler into a ball link following the same steps completed earlier on page 10.

□ 2.



4-40x5/8 (1)



#4 (1)



#4 (2)



Attach the ball link to the rudder control horn using a 3/32-inch ball driver and a 1/4-inch nut driver or pliers. Use the same order of components listed on page 8 for the control horn side.

You can attach the rudder and elevator linkages to their respective control horns following the aileron linkage installation instructions on page 8. You can set final center of the rudder and elevator control surfaces at this time.

□ 3.

Wire Crimp (2)



Thread the pull-pull cable through a wire crimp, then through the rigging coupler and back through the crimp. For extra security, you can loop the wire back through the crimp a third time. Repeat for the other side of the rudder. Center the rudder and tighten both cables as needed to keep the rudder centered. Use a crimping tool to permanently attach the crimp to the cables.

Adjust final cable tension by removing the ball links and tightening the ball links on the rigging coupler as needed. Be sure to keep the rudder centered in the process. Do not over tighten the cables. Note that the cable may stretch slightly during the first flights, and may need tightened subsequently.

LANDING GEAR INSTALLATION - ARF & ARFSV

Required Components

Fuselage Assembly	Landing Gear	Wheel Pant (R&L)
Main Wheel (2)	Axle (2)	M4 x 20 Screw (4)
M4 Lock Nut (4)	M3 Flat Washer (4)	M5 Lock Nut (2)
M3 x 15 Screw (4)	M5 Flat Washer (2)	M3 Flat Washer (4)

Required Adhesives

Blue Thread Lock

Required Tools/Building Materials

Ball Driver: 3/32-inch	Nut Driver: 1/4-inch	Flat File
Open-End Wrench: 8mm, 12mm	Felt-Tipped Pen	

□ 1.



Assemble the axle to the landing gear leg using a 8mm and 12mm open-end wrench. Fully tighten at this time.

□ 2.

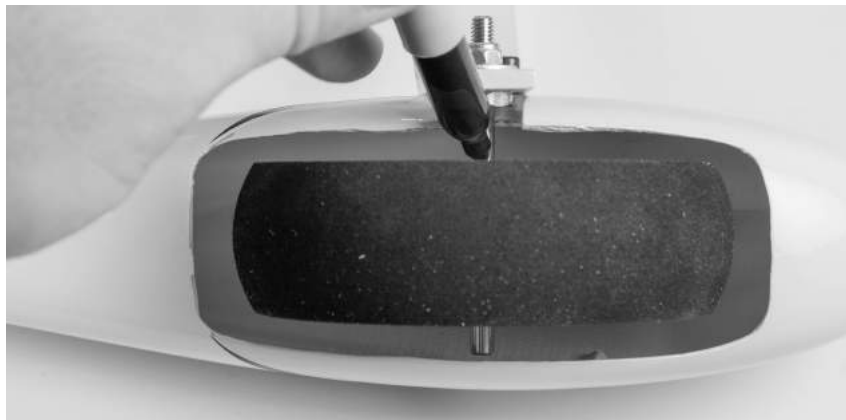

Temporarily slide a main wheel onto the axle, and attach the wheel pant in place using two M3x15 screws and two M3 flat washers. Center the wheel in the wheel pant, and mark the sides of the wheel on the axle with a felt-tipped pen. Remove the wheel pant and wheel.

□ 3.



Use a flat file to make two flat spots on the axle where the marks were made in step 2.

□ 4.

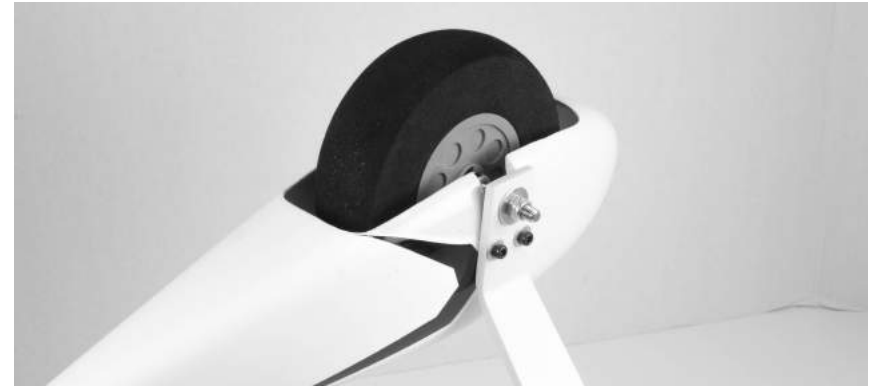

Slide an M4 wheel collar onto the axle with the flange away from the landing gear. Use blue thread lock on the set screw, and tighten the wheel collar down on the mark nearest the landing gear. Slide a main wheel onto the axle, followed by a second wheel collar with the flange facing the wheel. Use blue thread lock on the set screw, and tighten the wheel collar down against the wheel. Ensure the wheel spins freely.

To install the wheel pants, place an M3 washer onto an M3xXX screw. Apply a drop of blue thread lock on the screw, and run the screw through the landing gear leg, threading into the blind nuts located in the wheel pant. Before fully tightening, start the second screw (with blue thread lock) for that wheel pant. Now fully tighten both screws.

HELPFUL HINT

In order to help reduce damage to your model while building, the wheel pants can be installed last after completing the build.

□ 5.

x2



M4x20 (1)

M4 (1)

M4 (1)

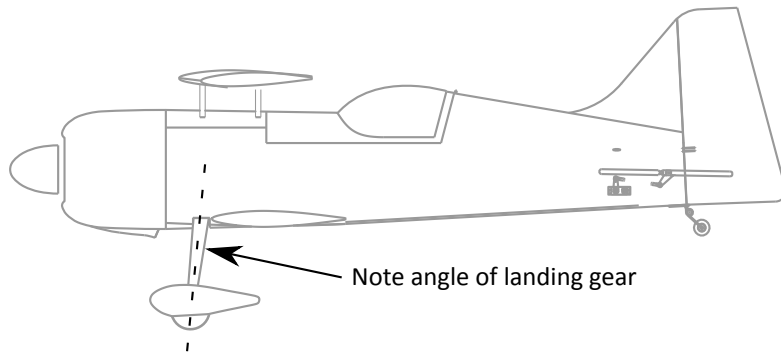

With the fuselage inverted on your work space, sit the landing gear on the fuselage so that it sweeps **forward** as it moves away from the fuselage. Place an M4x20 screw with an M4 washer through the landing gear, and through the hole in the landing gear mount in the fuselage. Using needle nose pliers, place the M4 lock nut on the screw, and tighten the screw. Repeat for the remaining 3 screws.

FUEL TANK ASSEMBLY - ARF & ARFSV

Required Components

Fuel Tank
Clunk

Brass Tubing (x3)
Fuel Stopper

Fuel Line
Stopper Ring

Required Adhesives

Dish Soap/Water (optional)

Required Tools/Building Materials

Pliers

You may choose to setup the fuel tank as you wish, but there is enough parts included in your kit for either a 3-line fuel system or a 2-line fuel system. A 2-line fuel system is recommended for it's simplicity and lighter weight. The instructions below will guide you through installing a 2-line fuel system.

□ 1.

x2

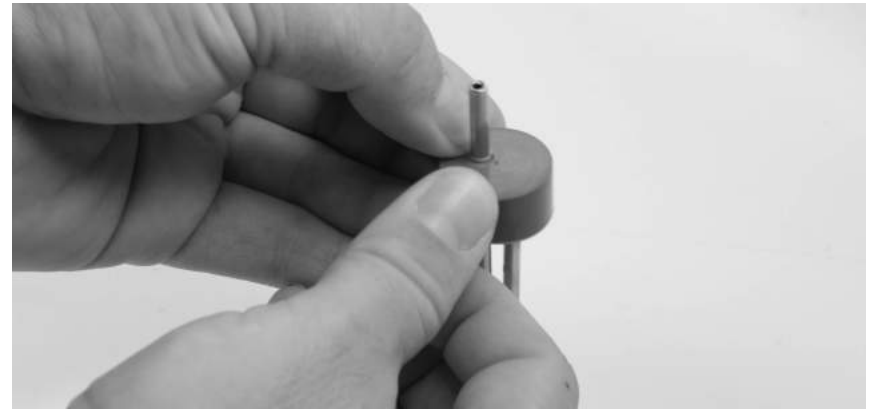

Combine a small amount of dish soap and water in a small pan or bowl. Locate the holes in the rubber stopper. Apply a very small amount of soap-water mixture to one of these holes. Using one of the smaller brass tubes, press the tube through the hole. Repeat for the second brass tube.

□ 2.

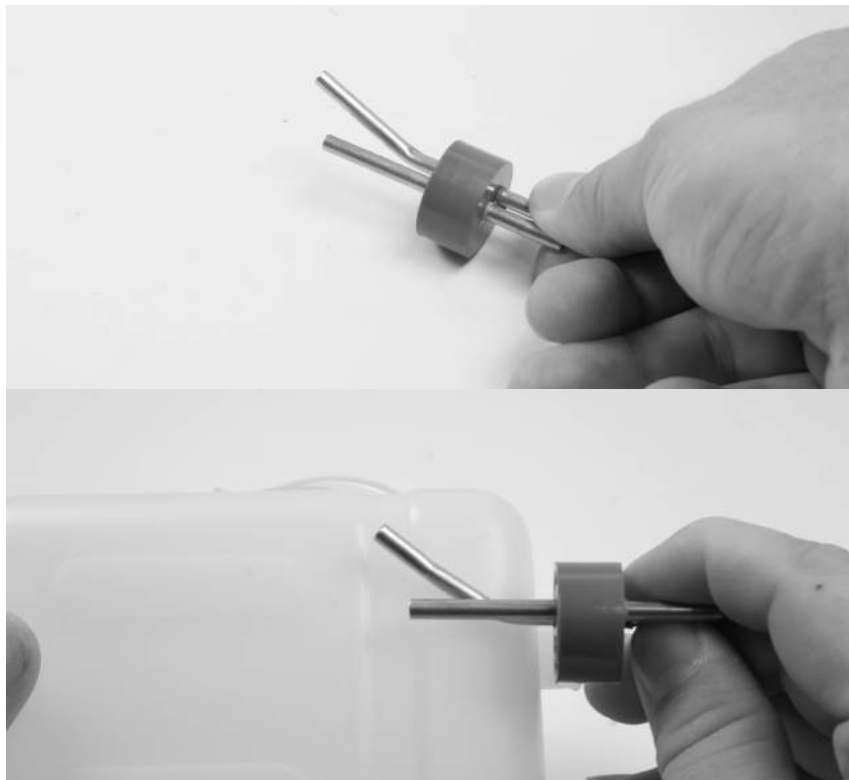

Using a pair of pliers, lightly grasp one of the tubes on the back side of the stopper (the side with the channel), and make a small bend in the tube as shown in the photo. This will be the vent side of the fuel system, and this bend in the tube allows the vent tube to go very near the top of the tank for the maximum amount of fuel capacity. You can estimate how close to the top of the tank you have bend the tubing by simply holding the stopper in place near the side of the tank. You may also extend this piece with a short amount of gasoline-safe fuel tubing.

□ 3.

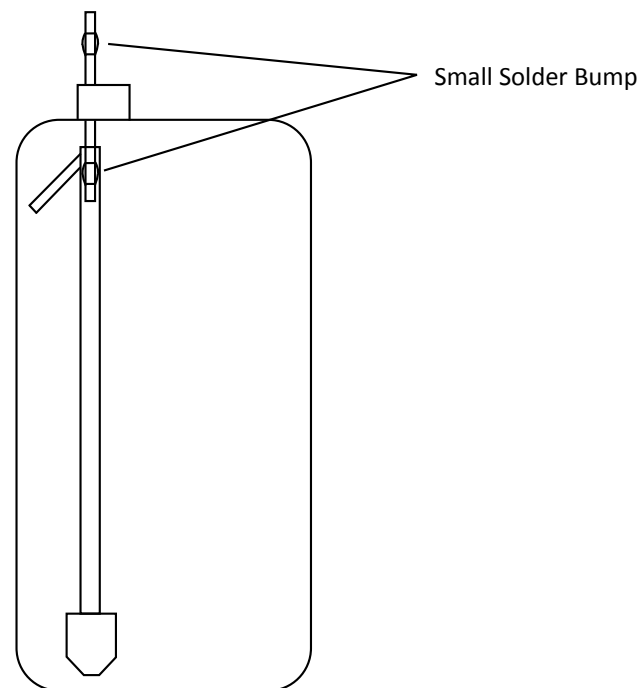

Cut a section of fuel tubing, and attach it to the fill side brass tubing. Attach the clunk to the opposite side of the fuel line. Assemble these parts so that the clunk nearly reaches the back side of the tank, but does not make contact with it. This is very important for this type of model, as gyroscopic maneuvers can easily get the clunk caught in a portion of the fuel tank. It is critical that the clunk does not come in contact with the rear of the fuel tank. It is also important that the fuel line not be too short, or the engine may not pull most of the fuel out of the tank. This may require a good bit of trial and error before the proper length is reached. Reference the diagram above. Once happy with the final length of your fuel line, secure the line to the brass tube and clunk using safety wire. You may also add a small "bump" of solder to the brass tubing to aid in securing the fuel line to the tubing.

□ 4.

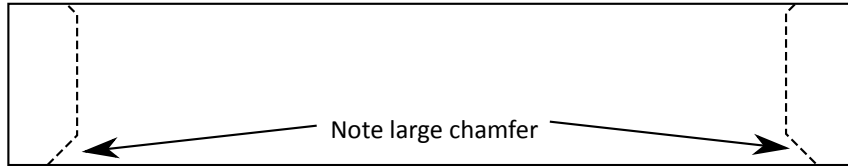

Locate the stopper security ring. Note that there are two chamfers on either side of this ring. One has a larger chamfer, and the other a smaller chamfer.

Press the fuel line side of the stopper assembly into the fuel tank. This may take a good amount of force to seat the stopper properly onto the neck of the fuel tank. Once fully seated, apply a small amount of soap-water mixture to the inside of the safety ring. Press the ring over the stopper with the large chamfer side towards the fuel tank. Set the fuel tank aside for later steps.

HELPFUL HINT

In order to help make future fuel system maintenance easier, you can mark the fill and vent sides of the fuel tank using a felt-tipped pen.

ENGINE & THROTTLE SERVO INSTALLATION - ARF & ARFSV

Required Components

Engine	Ignition System	Throttle Servo
Muffler System	Engine Accessories	Servo Extension - 18"
Shrink Tubing/String	1/4-20 x 1-1/2-inch Screw (X4)	1/4" Flat Washer
1/4-20 Blind Nut	15mm Engine Standoffs	
	(FPM1124 - 15mm Engine Standoffs (1/4" Inside Hole))	

Required Adhesives

Blue Threadlock Medium CA (optional)

Required Tools/Building Materials

Electric Drill Drill Bits: 1/8-inch, 5/16-inch 1/4-inch Hex Driver

The recommended engine and exhaust combination for the Mamba is the DA-70, twin cylinder gasoline engine, with standard mufflers. However, a 50-60cc single cylinder engine like the DA-60 will also work very well. For exhaust, the Mamba can use standard mufflers, or a single canister/pipe of 80mm diameter, with a rear exit. If using a twin engine, and you prefer to use a tuned pipe or canister, a 2-to-1 header system is required for this aircraft. Consult your engine manufacturer for recommendations.

□ 1.

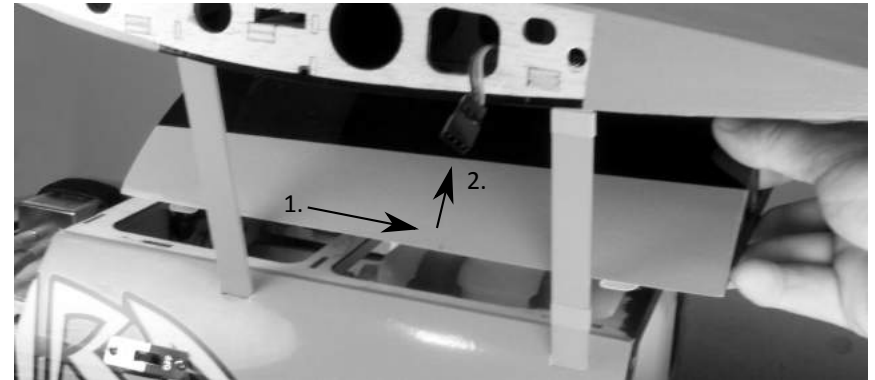

Remove the forward hatch by first removing the rear hatch (if applicable), then slide the forward hatch rearward, and lift up vertically on the entire hatch to remove it from the fuselage. Install in reverse order.

□ 2.

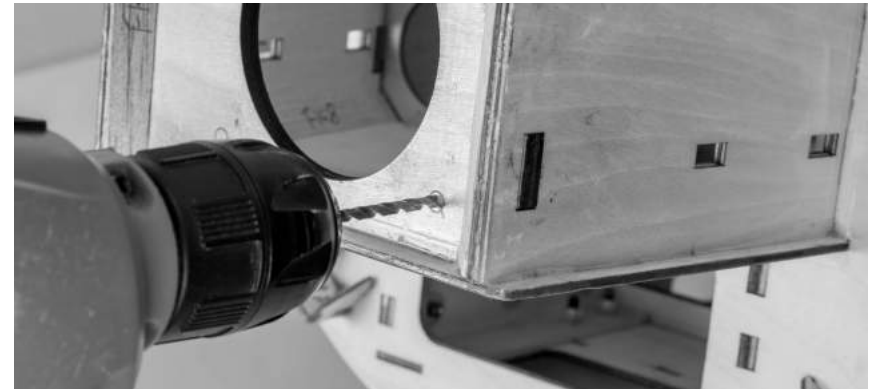

The motor mounting locations for the DA-70 and DA-60 are laser-etched into the firewall for your convenience. Use a 1/8-inch drill bit and drill to create a pilot hole in the center of these etchings in the firewall.

□ 2.

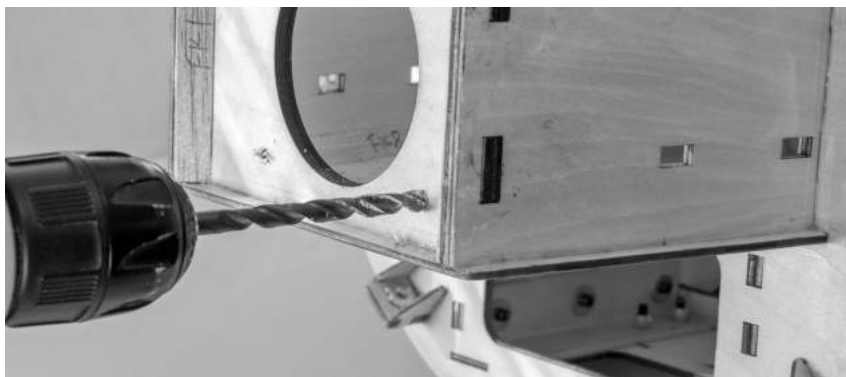

Use a 5/16-inch drill bit to enlarge the holes from the previous step. Verify that the hole is large enough to accommodate the blind nuts which will be installed in the next step.

□ 3.



1/4-20x1-1/2 (1)

#4 (1)



Use a 1/4-20 x 1-1/2-inch screw, 1/4-inch flat washer, and 15mm standoff to pull the blind nut into the back side of the firewall. Once fully seated in the firewall, you may apply some medium CA to help secure the blind nut. Let the CA fully cure before moving to the next step.

HELPFUL HINT

Depending on your particular engine or engine manufacturer, it may be easier to install the fuel line to the engine PRIOR to installing the engine onto the firewall.

□ 4.



1/4-20x1-1/2 (1)

#4 (1)

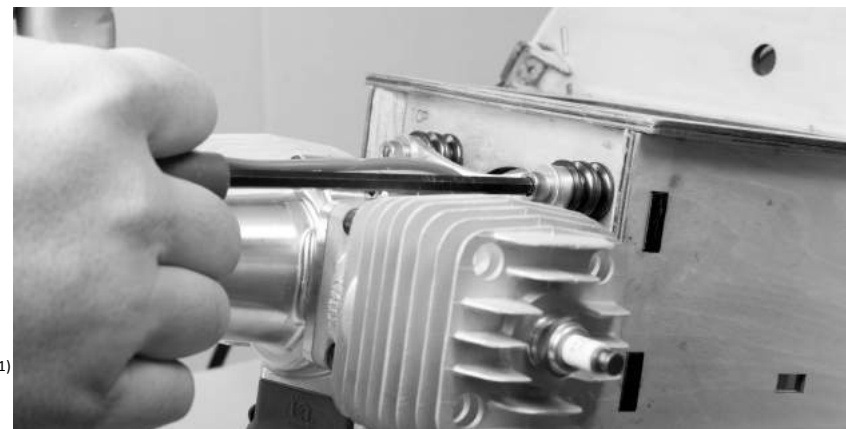

Mount the engine (without exhaust) to the firewall using (4) 15mm engine standoffs, (4) 1/4-20 x 1-1/2-inch machine screws, and (4) 1/4-inch flat washers. Be sure to apply blue thread lock to the motor mount screws.

□ 5.

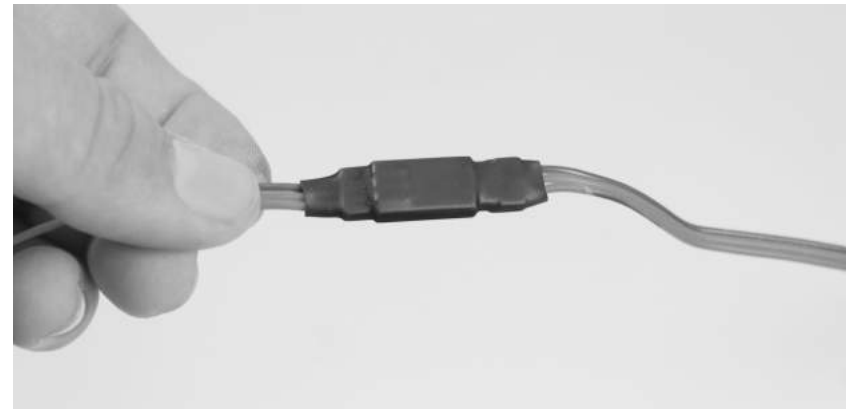

Prepare the throttle servo for installation by installing the rubber grommets and brass eyelets. Secure a 24-inch servo extension to the servo using shrink tube or thread.

There are several mounting options for the throttle servo in your Mamba. Throttle servo location will vary depending on your particular engine or engine manufacturer, but always choose the location with the best linkage geometry and least linkage interference to the throttle arm on your engine. The following photos show all of the mounting locations possible for the throttle servo. The location for the DA70 throttle servo setup is shown in the first photo.

- A. Twin Cylinder with Standard Mufflers

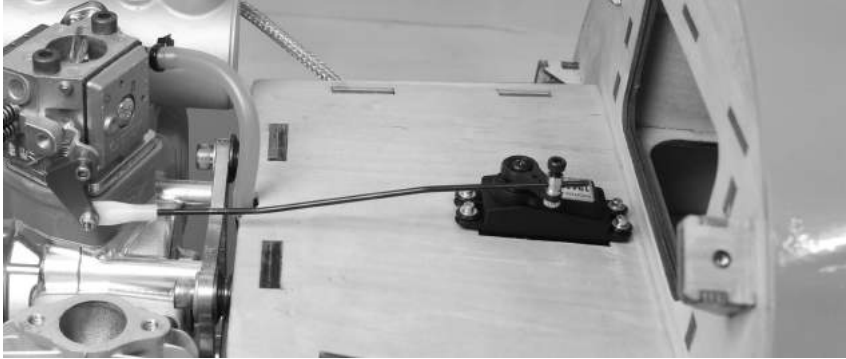

- B. Single Cylinder, Rear Carburetor, with Standard Mufflers Choke Servo or Throttle Servo



- C. Single Cylinder, Rear Carburetor, with Standard Mufflers or Canister, Choke Servo or Throttle Servo.



- D. Twin Cylinder with Canister

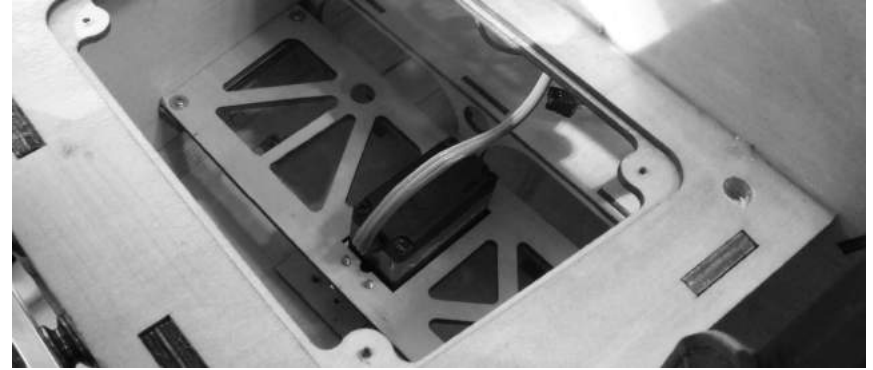

- E. Single Cylinder, Rear Carburetor, with Standard Mufflers or Canister, Choke or Throttle Servo

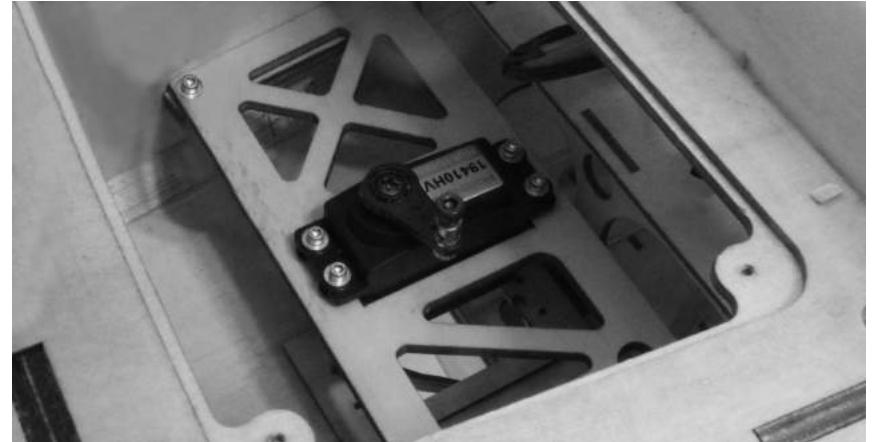

- 1.



Once you have selected your throttle servo location, use medium CA to glue the servo mount doubler in place. Be sure to secure it to the side of the mount with the **BOTTOM** of the throttle servo. This helps the servo mounting screw threads to be more secure, and also helps stiffen the throttle servo mounting location.

2. Should your throttle servo location require the optional throttle servo tray, complete the following steps to install the tray.



Part A (1)

Part B (4)

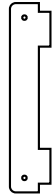
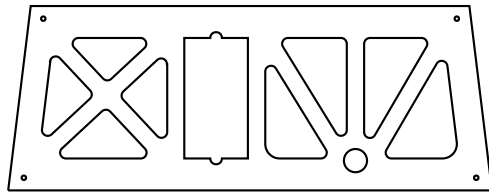

Locate the wood parts in the drawing above. Using medium CA, glue two "B" parts together to double their thickness. Repeat this for the remaining two parts.

- 3.

15

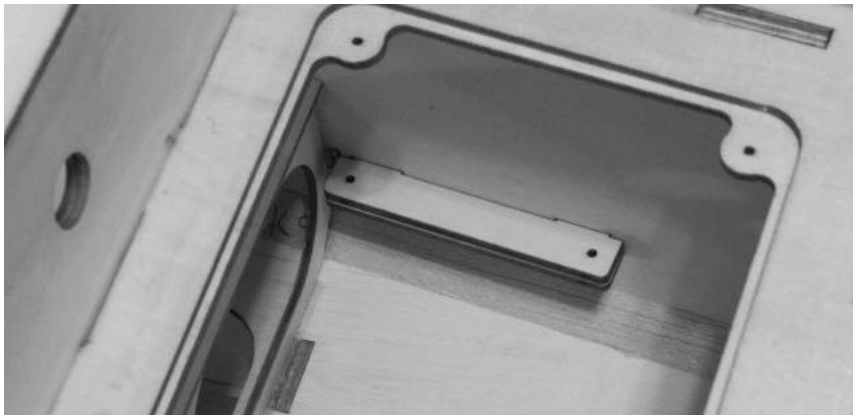

With the fuselage upright, mix a sufficient amount of 15-minute epoxy. Apply epoxy to the slots in the sides of the motor box, and coat the tabs of the part "B" assemblies. Slide one assembly into the slots of the motor box, cleaning any excess epoxy as necessary with a paper towel. Remove and re-insert the part to ensure you have fully coated the joint with epoxy. Ensure the parts are fully pressed to the sides of the motor box. Allow the epoxy to fully cure before moving on to the next step.

- 4.

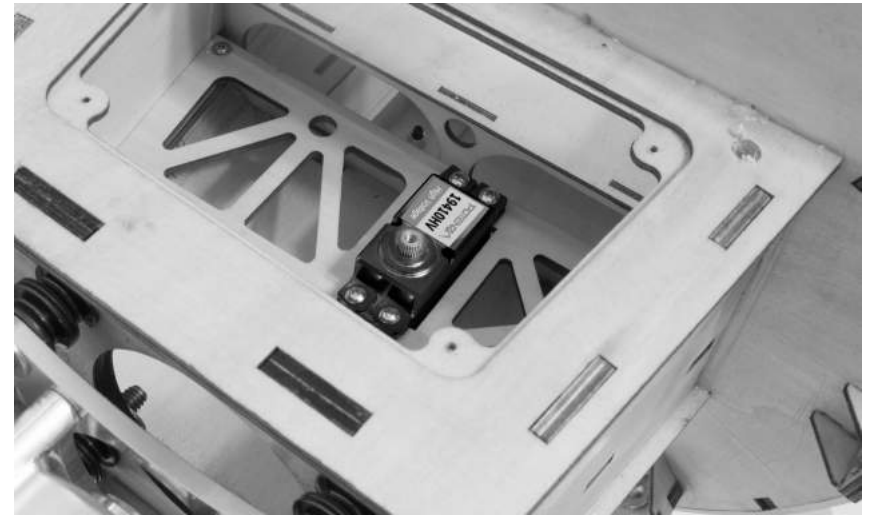

Choose the direction the tray will be mounted. Reference the photos on page 25.

- 5.

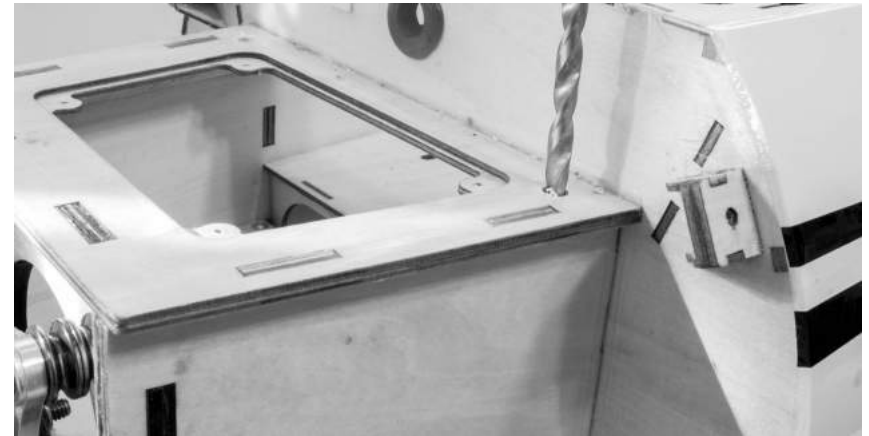

Use a drill with a 1/4-inch drill bit to drill two small holes in the top of the motor box. These holes will allow screwdriver access to the screws needed to secure the tray in place.

□ 5.



M2.5x8 (1)

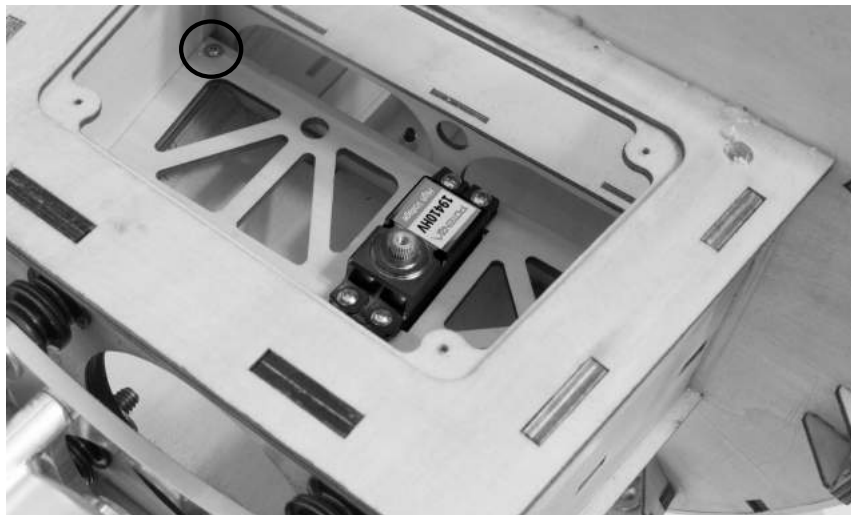

Secure the tray in place using (4) M2.5x8 self-tapping screws and a #1 Phillips screwdriver.

□ 6. (All Throttle Servo Locations)



M2x10 (1)

M2 (2)

M2 (1)

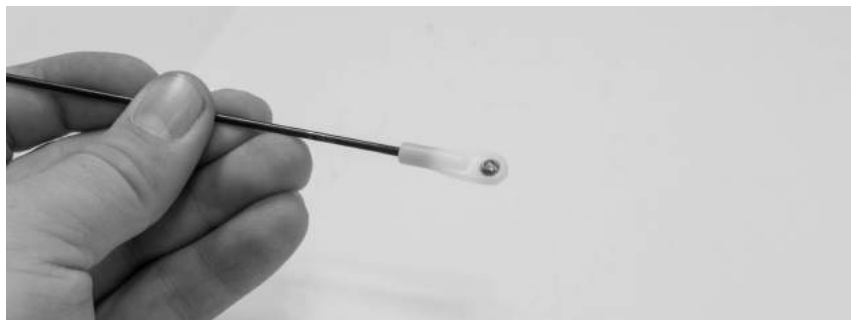

Locate the pushrod that is only threaded at one end. Thread this linkage approximately halfway into a **WHITE** ball linkage. Secure the ball link to your engine throttle arm using the 2 x 10mm screw, 2mm washers (2), and 2mm lock nut. Do not use thread lock on these parts, as it can weaken the plastic insert in the lock nut. The order of these components should be:

- Screw
- Washer
- Throttle Arm
- Washer
- Lock Nut

□ 7. (All Throttle Servo Locations)



Install the throttle servo with the output shaft towards the nose of the airplane. Use the radio system to center the servo, then install a 3/4-inch servo arm with the arm to the side of the fuselage that provides the best linkage geometry to the throttle arm on the engine. In the case of the DA 70, the arm should go to the right side of the fuselage (from the pilot's perspective).

□ 8. (All Throttle Servo Locations)



Quick Connect (1)



Secure the quick connector to your servo arm. Be sure to use blue thread lock for a secure attachment. The order of components is as follows:

- Quick connect housing
- Washer
- Servo Arm
- Washer
- Nut

9. (All Servo Locations)



M3x5 (1)



Remove the M3x5 socket head cap screw from the quick connect. Insert the non-threaded portion of the throttle linkage through the hole in the side of the quick connect. With the radio powered on, center the throttle servo and engine throttle arm. Use blue thread lock, and secure the M3x6 screw onto the linkage. Check throttle position relative to stick position, and make any changes necessary. Fully tighten the screw. Note that it may be necessary to make a slight bend in the throttle linkage to help prevent servo binding. Reference the photo above for the DA-70. .

IGNITION SYSTEM INSTALLATION ARF & ARFSV

Required Components

Fuselage Assembly	Ignition System	Ignition Battery
Regulator (If applicable)	Ignition Switch	

Required Adhesives

Thin CA

Required Tools/Building Materials

Phillips Screwdriver (#1)	Hook and Loop Tape	Hook and Loop Strap
---------------------------	--------------------	---------------------

1.

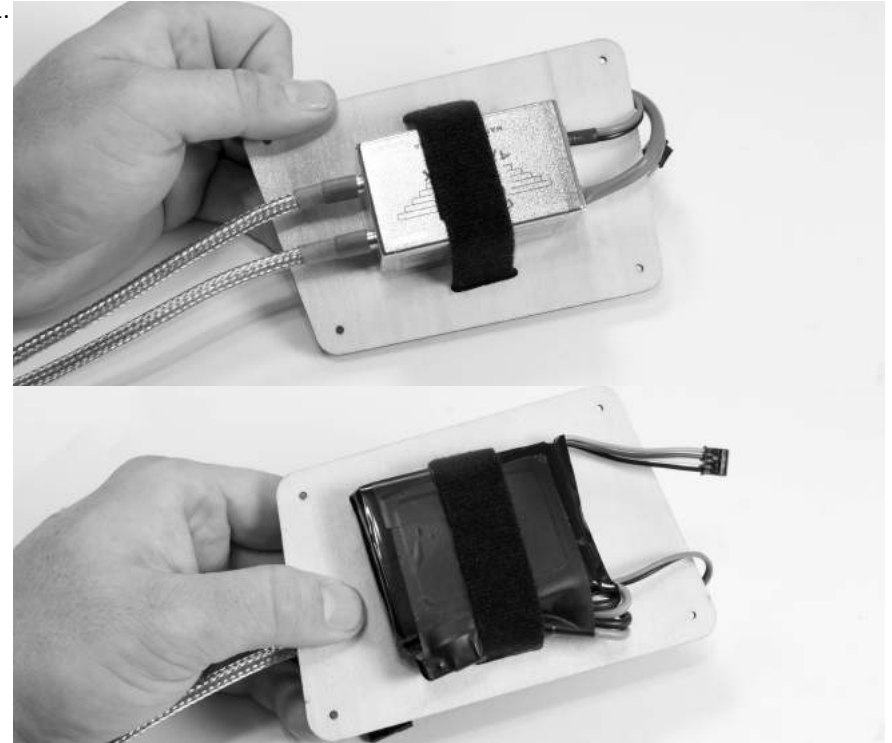

Install the the ignition per your engine manufacturer's recommendations. We recommend installing the ignition and ignition battery on the motorbox using adhesive-backed hook and loop tape, and a velcro strap. Slots or holes will need to be cut by a rotary tool into the motor box if you choose to use this method. Note that the location of ignition and ignition battery can affect the center of gravity of your model. Reference the CG section at the back of this manual. The location shown in the photos is just one of the many possible locations that you can mount your ignition system. Should your particular application require a regulator for the ignition, it can be mounted at this time.

2.

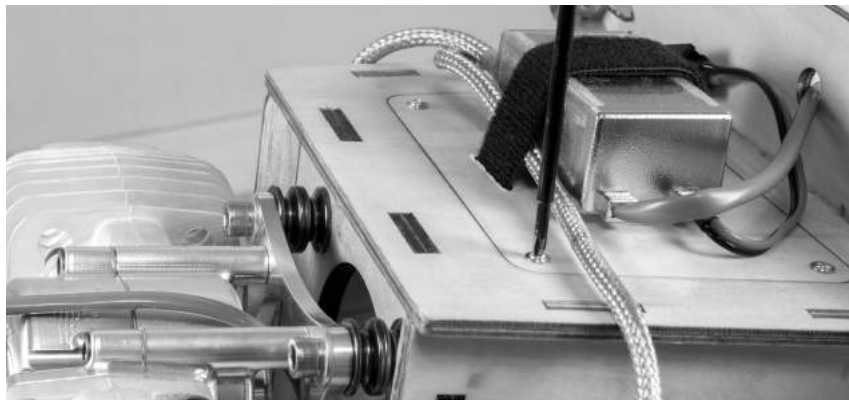

Thread a M2.5 x 5 self-tapping screw into each of the holes located in the top of the motor box. Remove the screws, and apply a small amount of thin CA to harden the threads cut by the screw. Once the CA has fully cured, install the top plate onto the motor box using the M2.5 x 5 self-tapping screws. Be sure to fully tighten at this time.

3.



Locate the ignition switch hole towards the nose of the fuselage. Note that there are switch locations on both sides of the fuselage. Remove the covering from the hole of your choice using a hobby knife with a #11 blade, and install your ignition switch. Use blue thread lock if your switch uses screws with metal to metal contact. **DO NOT** use thread lock if your screws thread into plastic! Be sure to make all of the proper connections to your battery, ignition module, and regulator (if applicable), and secure those connections with heat shrink or thread. Secure any loose wiring to the airframe at this time.

HELPFUL HINT

With the gravitational forces applied to today's aerobatic models, it is extremely important to secure any loose wiring to the airframe. Wires that are left loose in the model can rub against the airframe structure and cause an electronic failure.

EXHAUST INSTALLATION ARF & ARFSV

Required Components

Fuselage Assembly	Engine Exhaust	Exhaust Accessories
-------------------	----------------	---------------------

Required Adhesives

Blue Thread Lock	15-Minute Epoxy
------------------	-----------------

Required Tools/Building Materials

Phillips Screwdriver (#1)	Ball Driver: M3, 7/32-inch	XX
---------------------------	----------------------------	----

The steps below are broken up into two sections; A and B.

Step A is for standard muffler exhaust systems only

Step B is for a single 80mm canister with a rear exit only

1 A&B.

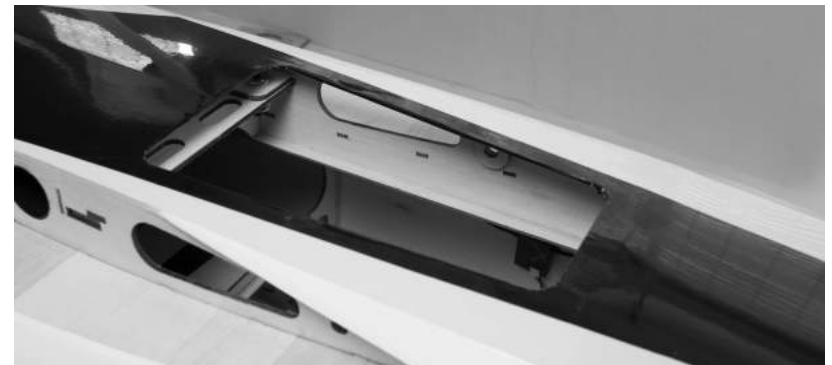

To aid in cooling, remove the covering from the bottom of the fuselage just aft of the lower wing bolt mounting location. Leave approximately 1/8-inch extra covering around the edges, and wrap the covering into the fuselage using a sealing iron.

2A.



If using a standard muffler system, install your muffler system using the hardware provided by your engine or exhaust manufacturer.

□ 2B.

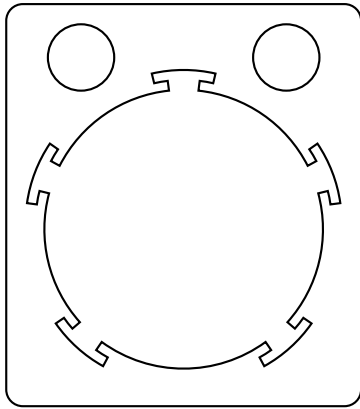

Locate the canister mount included with your Mamba. This mount is designed to fit a single 80mm canister only. The recommended header drop for the DA-60 is 0mm. If using the DA70, and you wish to use a canister, a two-to-one header system with a header drop of approximately 40mm is required.

□ 3B.

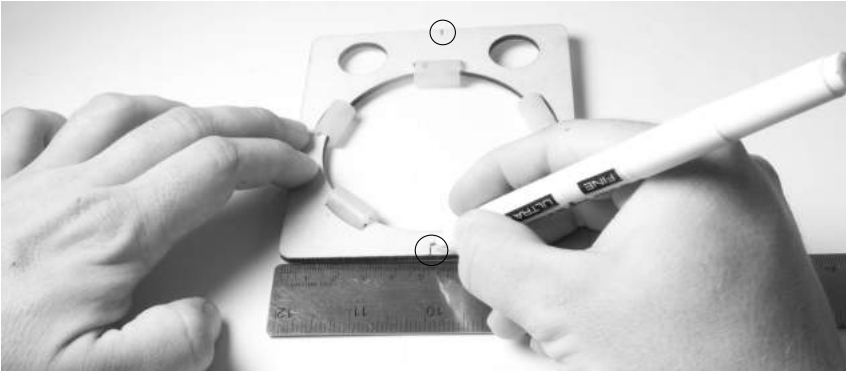

Use a ruler and a pencil to mark center line on top and bottom of the canister mount, as well as the former just aft of the fuel tank location.

□ 4B.

15

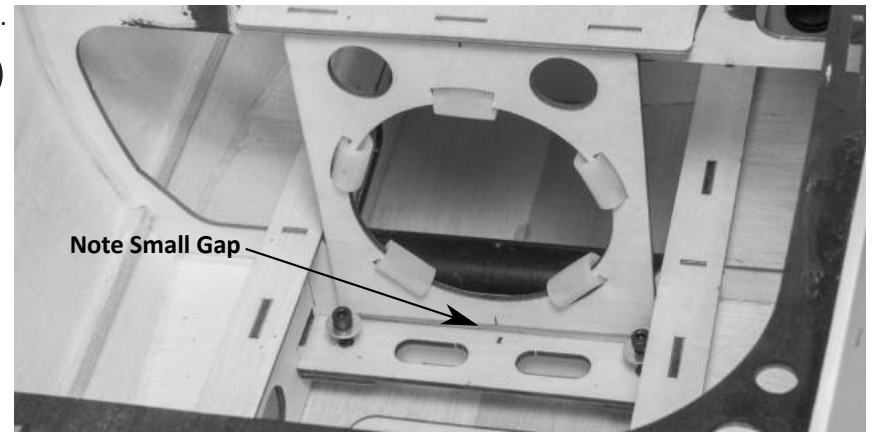

Mix a sufficient amount of 15-minute epoxy and apply it to the top and bottom of the canister mount. Align the marks made in the previous step, and ensure the mount is flush against the fuel tank tray above the mount. Note that the bottom of the canister mount will have a small gap to the former below. Tape the mount in place to cure with low-tack tape.

□ 4B.

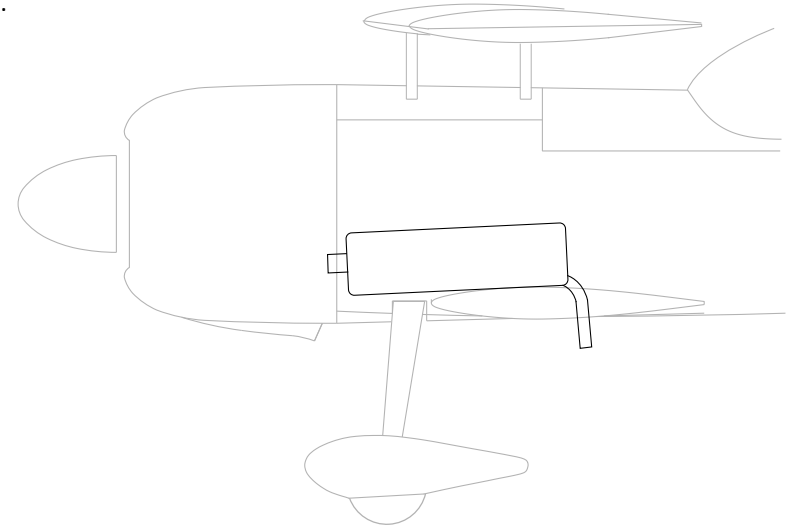

Slide the canister into the mount. Depending on the exhaust tube length, you may need to rotate the pipe 90 degrees to get the exhaust tip through the fuselage mount. Be sure the exhaust exit completely clears the bottom of the fuselage so that no exhaust will escape into the fuselage.

5B.

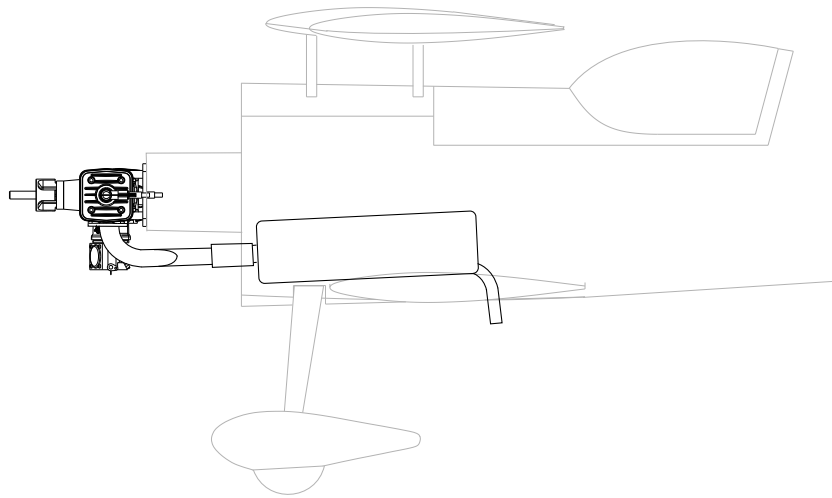

Connect your canister to your header system per your exhaust and header manufacturer's recommendations. Once the header is connected to the canister, attach the header(s) to the engine using the hardware provided by your exhaust manufacturer.

FUEL TANK INSTALLATION ARF & ARFSV

Required Components

Fuselage Assembly
Fuel Line Clamps

Fuel Tank Assembly

Gasoline-Safe "Large"
Fuel Line

Required Tools/Building Materials

Hook and Loop Strap (2)

Hook and Loop Tape

1.



Connect a section of fuel tubing approximately 12 inches (XXmm) in length to the fill or "clunk" line of the fuel tank. Secure this section of line to the brass tubing using one of the provided fuel line clamps.

2.



Connect a fuel line "T" to the line you just connected to the fuel tank. Connect two more 12 inch sections of fuel line to this fuel line "T". Secure all connections using a tie-wrap or another method of your choosing.

- 3. Secure a section of fuel tubing approximately 36 inches (90cm) in length to the vent side brass tubing on the fuel tank, following the same instructions as the fill side.



Apply a vibration-dampening material (such as foam or hook and loop tape) to the bottom of the fuel tank.



Prepare the fuel tank tray for fuel tank installation by inserting hook and loop straps or tie wraps through the laser-cut slots in the tray. Place the fuel tank on the tray, and secure it in place.

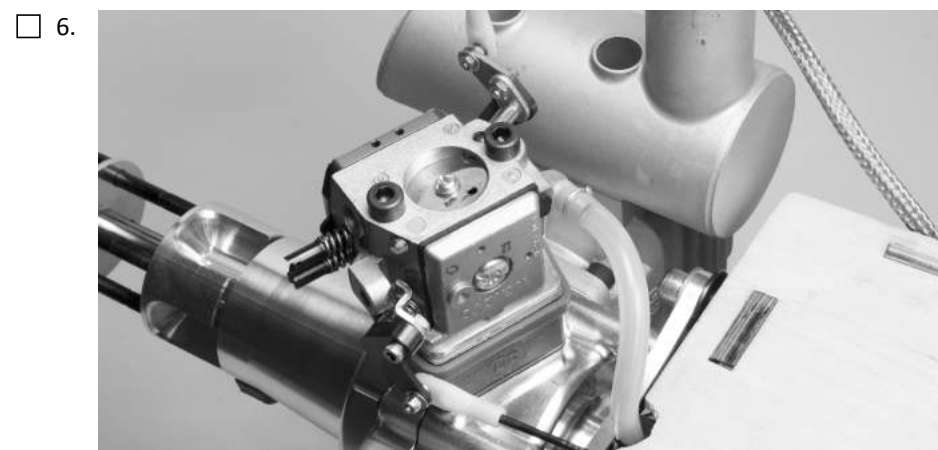

Run the clunk line to the engine, and connect it to the carburetor. Secure the line to the engine using a heat-resistant material like safety wire or a fuel line clamp.



Route the vent line such that it goes behind the fuel tank, and exits forward of the fuel tank near the bottom of the fuselage. Secure it in place using a method of your choosing. Run the fill line from the "T" fitting to the same location as your vent line, and use a plug to keep air from entering the fuel system. The fill line does not need to be wrapped around the fuel tank.

COWLING INSTALLATION ARF & ARFSV

Required Components

Fuselage Assembly	Cowling	M3 Washer (6)
M3 O-Ring (6)	M3x15 Screw (6)	

Required Adhesives

Blue Thread Lock

Required Tools/Building Materials

Ball Driver: M3, 7/32-inch

□ 1.



Create and attach any necessary choke linkages prior to these steps. Test fit your cowling. Use a felt-tipped pen to mark the location that the cowling needs to be cut for the exhaust to extend through the cowling. Use a rotary tool with a sanding drum to remove a small amount of material at a time. Ensure that you have at least 3mm (1/8-inch) of clearance around the exhaust to prevent the cowling from rubbing the exhaust during flight.

□ 2.

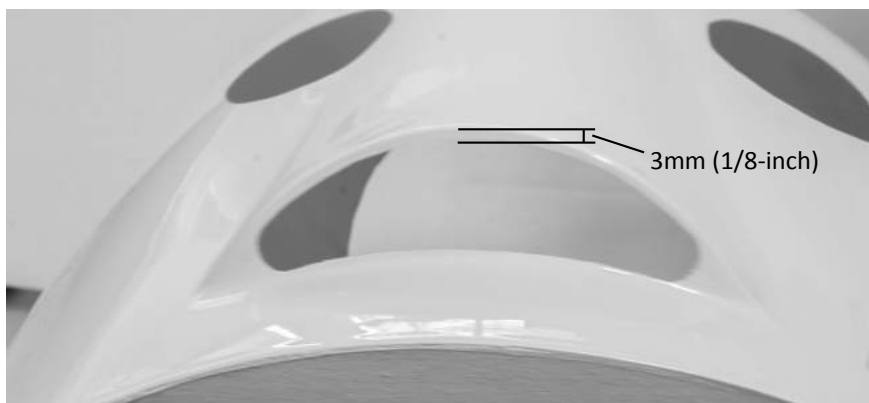

Before final installation of the cowling, use a rotary tool to remove material from the aft side of the cowling scoop to allow airflow to exit, and ensure adequate motor cooling. Be sure to leave approximately 3mm (1/8-inch) of vertical area to maintain strength in the cowling. Also be sure that you keep all corners round to help prevent cracking.

□ 3.

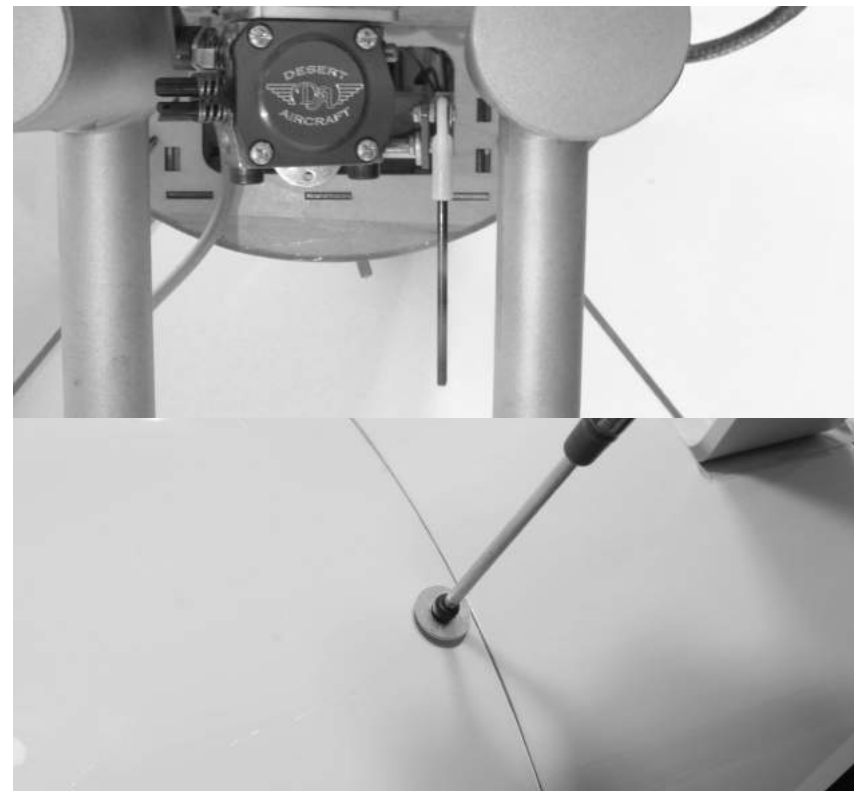

Make and install any necessary choke linkages, and install the cowling using (3) 3x15mm screws, (3) 3mm o-rings, and (3) 3mm washers. The o-ring should be placed between the washer and cowling. Be sure to route any choke linkages out of the cowling before securing it in place.

□ 4.



Install your propeller and spinner at this time. For the DA-70, we recommend a Falcon 24x9 gas carbon fiber propeller, and a 5-inch aluminum spinner.

CENTER SECTION INSTALLATION ARF & ARFSV

Required Components

Fuselage Assembly
M3x15 Screw (8)

Top Wing Center Section
M3 Washer (8)

Cabanes (4)

Required Adhesives

Blue Thread Lock

Required Tools/Building Materials

Ball Driver: M3

□ 1.



Locate the holes in the fuselage for the center cabane struts. Remove the covering from these holes using a sharp #11 hobby knife blade.

□ 2.



Insert a cabane strut into the slot opened in the previous step. Install the strut using two M3 x 15 screws and two M3 washers. Be sure the top of the strut extends out towards the wing tips. Repeat this process for the other 3 cabane struts.

□ 3.



Locate the holes for the wing bolts in the top side of the wing center section. Remove the covering with a #11 hobby knife blade, being sure to leave approximately 3mm (1/8-inch) excess inside the hole. Use a covering iron to seal the covering down into the hole. Be sure to uncover the proper holes, as there are other similar holes in the top of the wing.

□ 4.



Locate the holes for the cabane struts in the bottom side of the wing center section. Remove the covering with a #11 hobby knife blade, being sure to leave approximately 3mm (1/8-inch) excess inside the hole. Use a covering iron to seal the covering down into the hole.

□ 5.

x2



M4x8 (4)

M4 (4)



With the airplane inverted on your workspace, and the tops of the struts accessible, align the center section with the cabane struts. Use a 3mm ball driver to insert an M4 x 8 socket head cap screw and M4 washer through the strut and into the blind nut located in the wing center section. Fully tighten the screw.

HELPFUL HINT

To help ensure a true and straight airframe, it is best to start all 4 screws without tightening them down fully. Once all four screws have been started, tighten the screws in an "star" style pattern until they are fully tightened. This also can help prevent any alignment issues with other struts or parts.

□ 5.

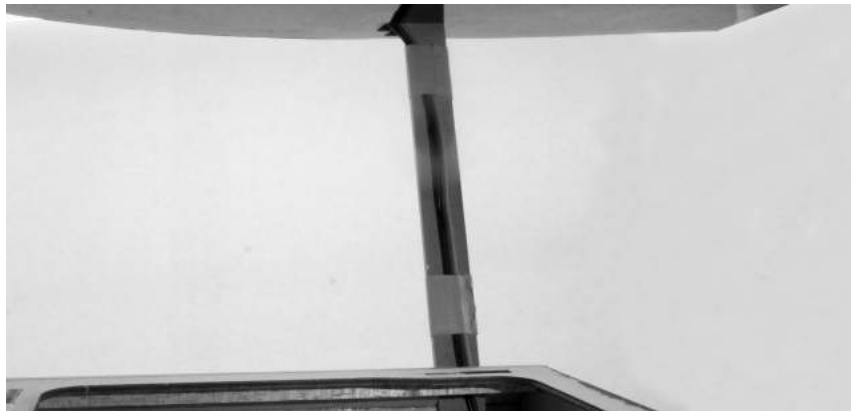

Route two 24-inch heavy duty servo extensions up the rear cabane strut, and out the wing center section as shown. Secure the extension to the cabane struts using tie-wraps or tape.

You can also route two 18-inch extensions for the lower wings at this time.

RADIO GEAR INSTALLATION ARF & ARFSV

Required Components

Fuselage Assembly	Receiver Batteries	Receiver
Receiver Switch	Aura 8 AFCS (Optional)	Aura Brace (Optional)

Required Tools/Building Materials

#11 Hobby Knife	Hook and Loop Straps	Tie-Wraps
Hook and Loop Tape		

Required Adhesives

Medium CA

□ 1.

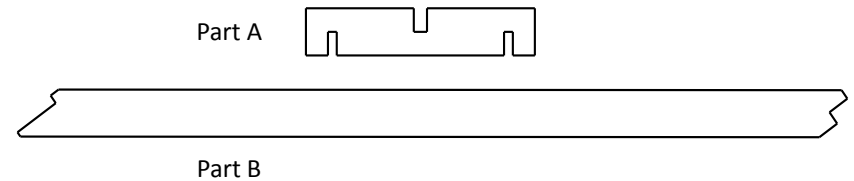

If you are using the Aura 8 AFCS, or other stabilization system, it should be mounted forward of the rudder servo location in the center of the fuselage, under the canopy. Locate the Aura brace parts shown in the above drawing. This brace eliminates tray flex, and is required with the installation of your Aura 8.

If using the Aura 8, you can download our **PRE-CONFIGURED** model file at:

www.flexinnovations.com/aura

This brace installation is not required if you are not using a stabilization system, and you can install your radio gear at this time. Various hook and loop strap and switch locations offer a variety of mounting locations for your radio gear.

Note that the center of gravity (CG) may vary considerably depending on many factors, such as engine selection, elevator and rudder servo locations etc. It is best to mount your receiver batteries in a location that provides the proper CG location so that no additional weight is required. Consult the center of gravity section of this manual.

□ 2.

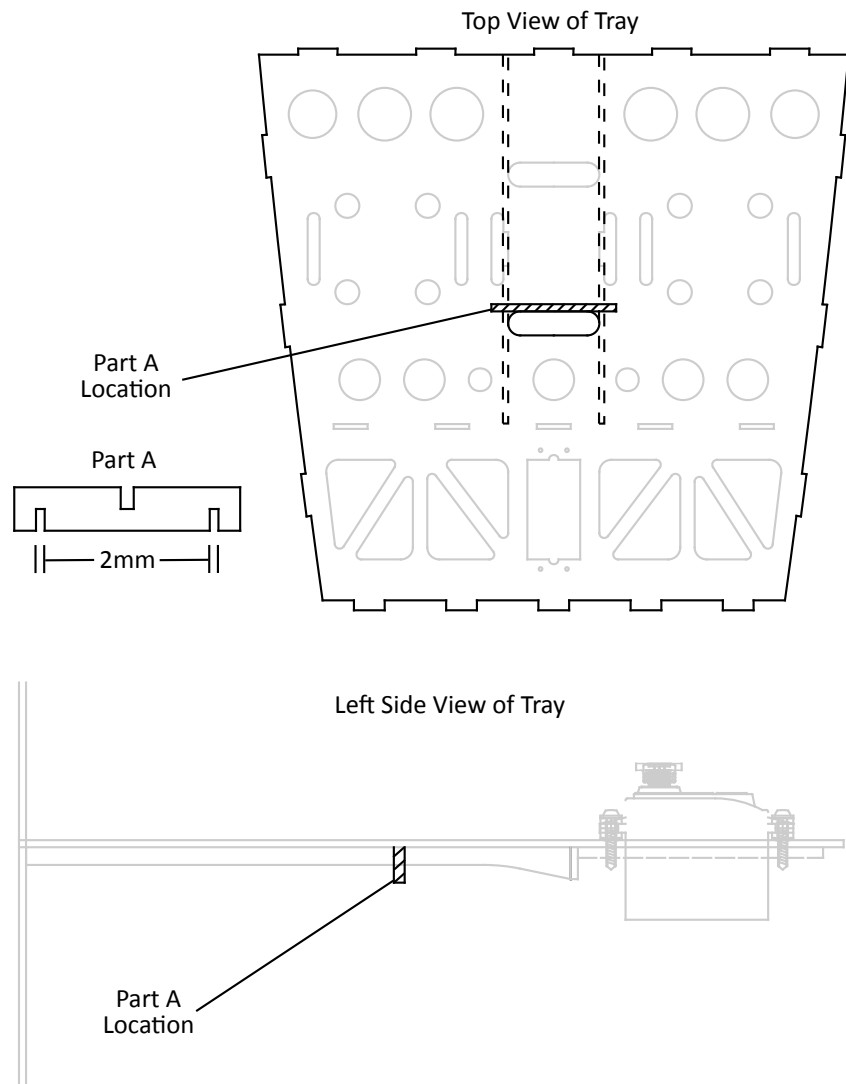

Use medium CA to glue part A to the underside of the radio gear tray. Reference the drawings above for its location. Note that there are two, 2mm thick, pieces of reinforcement that run under the radio tray. Part A will interlock at the outside most notches (2mm) with these two pieces, and should sit perpendicular and flush against the bottom side of the radio tray.

□ 3.

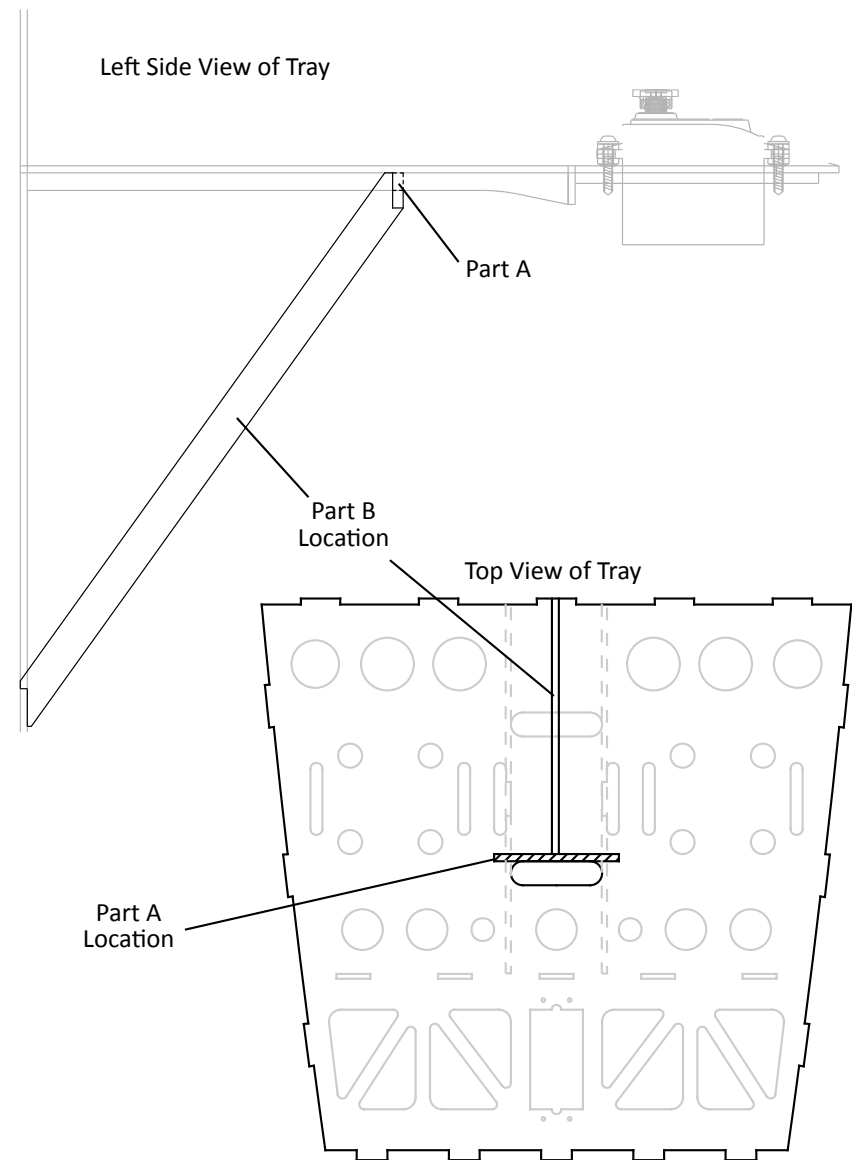

Test fit Part B in the location shown in the drawing above. Once satisfied with the fit, use medium CA to secure in place.

SHARK TEETH INSTALLATION ARF & ARFSV (OPTIONAL)

Required Components

Main Wings (4) Shark Teeth Strips (4)

Required Adhesives

15-Minute Epoxy

Required Tools/Building Materials

Low-Tack Tape Mixing Cups Mixing Sticks
Isopropyl Alcohol Paper Towels

1.



Locate the slots in the leading edge of the wing starting at the tip rib just before the taper at the tip of the wing. Each shark tooth slot is approximately 11-3/4-inches (300mm) in length from the tip rib. Use a #11 hobby knife to open the slots at the leading edge of each wing panel. Test fit the shark teeth strips into these slots. Ensure everything fits and aligns properly.

2.



Apply low-tack tape to the shark tooth strips, leaving only the area that extends into the wing panel uncovered. Use a medium grit sand paper to sand both sides of this exposed area.

3.

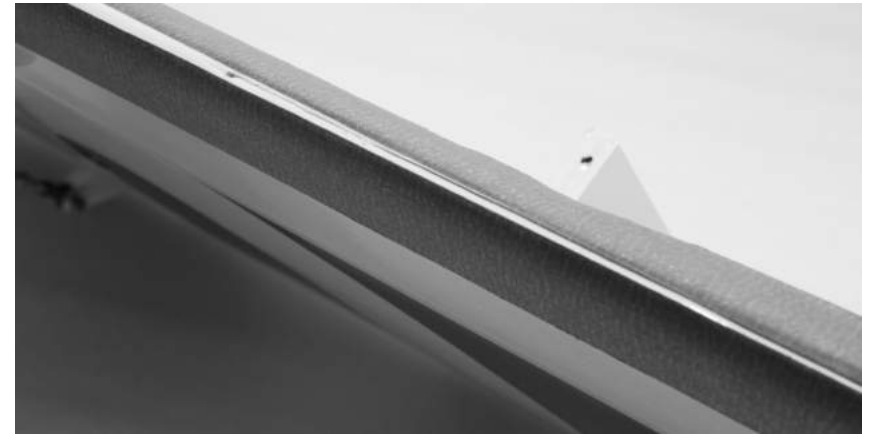

Apply low-tack tape on each side of the slot in the wing panels. Leave a small gap approximately 1/16-inch (1.5mm) between the tape and the slot.

4.

15

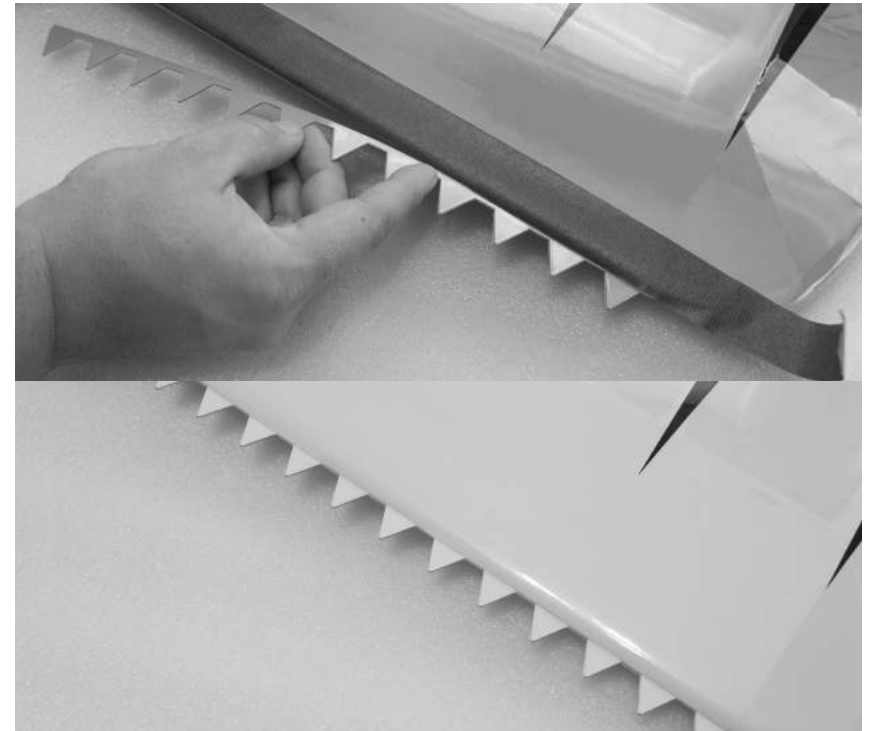

Mix a sufficient amount of 15-minute epoxy, and use a toothpick to apply it within the slot in the leading edge of the wing. Insert the shark tooth strip into the wing, being sure it has been fully coated with epoxy. Before the epoxy fully cures, remove the tape, and clean up any excess with isopropyl alcohol and paper towels.

FIELD ASSEMBLY ARF & ARFSV

Required Components

Fuselage
Strut Retaining Pins
M4x15 SHCS (4)

Wings (4)
Fuselage Hatches
M4 Washer (4)

5 Interplane Struts
Wing Tubes (2)
M4 O-Ring (4)

Required Tools

M3 Ball Driver

Required Adhesives

Tape

□ 1.



M4x15 (2)

M4 (2)



Remove the rear canopy hatch from the fuselage. Slide a wing tube into one lower wing panel. Partially slide the wing tube (with wing) into the lower wing tube socket. Be sure there are no bolts in the wing bolt location. Secure the aileron servo lead to the servo extension, and fully slide the wing into place, being sure not to pinch any wiring between the wing and fuselage. Secure the wing with an M4 x 10 socket head cap screw M4 washer, and M4 o-ring. Repeat for the other lower wing.

□ 2.



M4x15 (2)

M4 (2)



Repeat the same process for the top wing panels.

□ 3.



Be sure the interplane strut wire is removed from the strut. Slide an interplane strut into place. Note that the struts are directional, and will only fit one way. Push the straight end of the wire through the strut, and through the wing strut block until the angled portion of the wire is flush with the strut. Secure the wire with tape. Repeat for both top and bottom sides of each strut.

CENTER OF GRAVITY

Setting the center of gravity is one of the most important steps for success, particularly with a new airplane. The Premier Aircraft Mamba 70cc is a high-performance airplane with large control surface throws, and a very high thrust to weight ratio. These two factors combined make the Mamba a very enjoyable aircraft to fly, but if the center of gravity is not within an acceptable range, it will make the airplane difficult, if not impossible, to control. In order to have the most success and enjoyment from your Mamba, please follow the next few steps very carefully.

Before balancing your model, please ensure that all of the components are installed in your airplane when checking CG. This means the batteries, servos, linkages, hardware, propeller, spinner; everything. The airplane must be in ready-to-fly condition, otherwise the measurement will not be accurate.

There are several methods for determining center of gravity, from using a CG machine, to using fingers and a friend. Regardless of the method used, ensure that the tests are accurate and repeatable. If there are any inconsistencies between measurements, work to isolate the source of the error(s) to ensure that the test can be repeated with the same results. If lifting the model by the wing tips, do NOT lift directly from the tip of the wing, but lift at the tip-most wing rib location or damage to the model may result.

The location of the center of gravity for the Mamba 70cc is **81mm (3-3/16-inches) AFT** from the **LEADING EDGE** of the **BOTTOM WING**. It is critical that the starting point for your model be at this point. This measurement is determined from many test flights by designer and many time world aerobatic champion, Quique Somenzini.

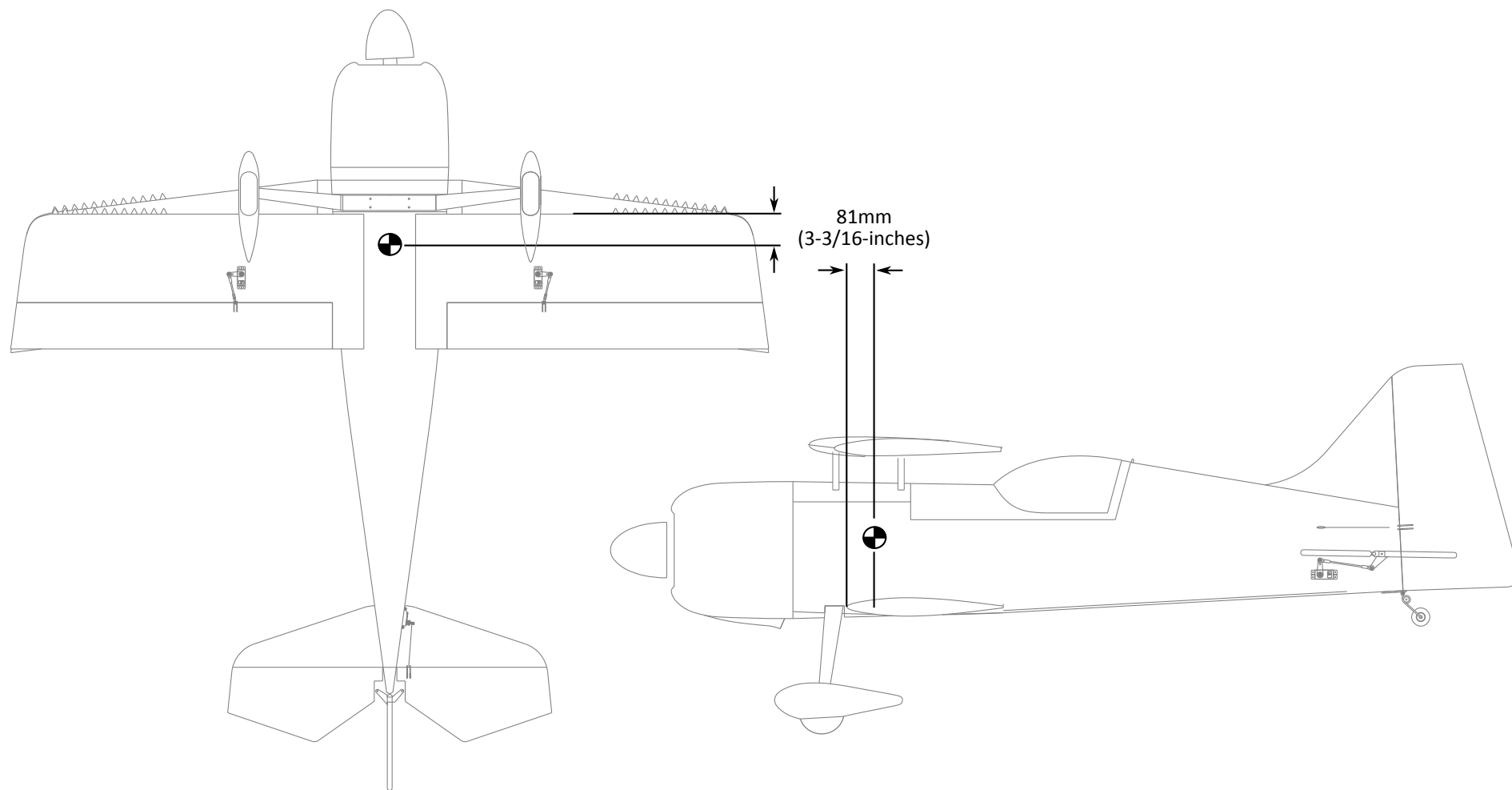

DECAL INSTALLATION

Use the photos provided below, as well as the images on the box for a guide to apply decals to your model.

1. Thoroughly clean the model to ensure that it is free of oil, fingerprints, and dust.
2. Separate the decals, but do not remove the paper backing at this time.
3. Prepare a dishpan or small bucket with a mixture of warm water and liquid dish detergent. The ratio should be approximately one teaspoon per gallon of water.
4. Submerge the decal into the water/soap mixture and gently remove the paper backing. Removing the backing under water prevents fingerprints from being visible on the back side of the decal.
5. Apply some water/soap mixture with your palm to the area desired. Once the area is saturated, position the sticker on the airplane. *Even though these are not water transfer decals, using wet application methods allows the sticker to be repositioned, reduces bubbles, and eliminates fingerprints and other blemishes from being visible.*
6. Hold the decal in place and use a paper towel to gently wipe most of the water away.
7. Use a soft piece of balsa or similar and squeegee the remaining liquid from underneath the decal.
8. Repeat until all decals are applied. Do not move, or otherwise touch the model for at least 12 hours to allow the rest of the water to evaporate.

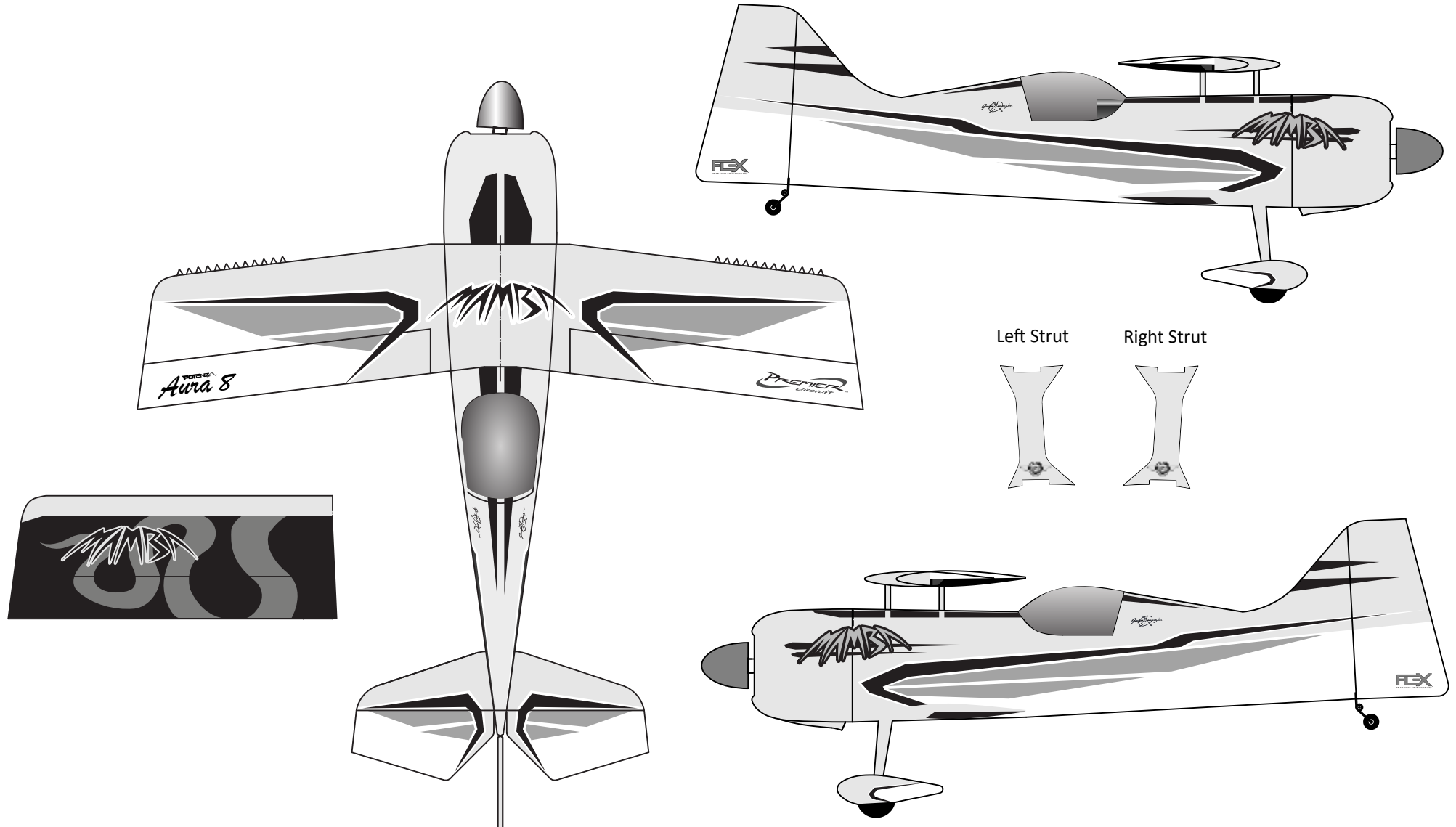

AURA 8 AFCS SETUP

If you choose to use the Aura 8 Advanced Flight Control System (AFCS), you can download a pre-configured Aura program for the Mamba at:

www.flexinnovations.com/aura

This model file is a relatively advanced example of a 4 servo biplane with the "crow" airbrake enabled. It does NOT require an extra channel for crow, as crow is driven only by selection of FM1, with Aura *Mixes* from throttle into a 'proxy Channel (21)' to split the ailerons using *Custom settings* in the *Servo Ports* tab. Gyro's are able to be in the loop at all times, and at optimum stick priority gain mapping.

- 3 flight modes (1: High Rate/High Gain/Crow, 2:Low Rate/Low Gain/No Crow, 3: High Rate/High Gain/No Crow)
- Quick Set: Disabled
- Quick Trim: Enabled
- Master Gain: Enabled on CH6/Aux1
- Mixes (Mix 1) to Channel 21 (a Proxy or Phantom channel in Aura) from Throttle...Crow increases from Mid Throttle to Low Throttle in FM1
- Ch 21 added as Source 2 in each Aileron Servo Port to allow inclusion of Crow Data.
- Download: (Done as Futaba S.Bus but you can easily change in setup for other brands/connections).

Note: 3D Gains are relatively high. High speed flight may cause oscillations with these settings.

This model file is in a base to be customized. You are expected to adjust *Direction*, *Output Scale*, *Mix Rates*, etc. to match your model. Perform and pass all transmitter command and sensor checks before flying! If you are near the 'limit' of your servo or linkage travel, use *Min/Max Servo Pulse Width* to set a protection limit.

You can easily 'build' on this model and customize it. If you want 'crow' driven by transmitter data, instead of a 'proxy', simply disable Mix 1 and use a transmitter channel (ex: CH7) instead of Ch 21 as Source 2 on the Servo Ports Tab.

Tips: Focus on the normal aileron setup first getting them centered, and equal (or desired) travel on each surface using a ruler and the *Output Scale* adjustments for each Servo/Port. Next add/deploy the crow, and use the *Source 2* Mix value and the ruler to put equal (or desired) Crow into each Aileron.

** This program was flown with a Futaba T8J Transmitter. Since all 3 flight modes are 'Gyro Enabled', for safety/test a 2-position switch is used on the Master Gain to turn the Gyro action on/off with CH6. Perform the take-off and climb to a safe altitude with the gyro off.

Relevant CH6 settings in the T8J are: Switch E set to change CH6 data, CH6 Direction=Reversed, CH6/FLP Travel=0/100. (The 0 will give centered CH6 output which is Gyro Gain as set in the Aura Config Tool, and the '100' will give CH6 Low output, which is Gyro Gain 'OFF'. You can check this in your transmitter monitor.

Reference the drawing below for the recommended location of components (specifically the Aura 8). It is also important to install the Aura stabilizing brace (instructions on page 35) to eliminate any tray flex that could cause vibration or servo oscillation issues with your Aura. Be sure to use the double-sided foam tape included with your Aura, and be sure to install a hook and loop strap around your Aura to prevent it from coming loose in your Mamba.

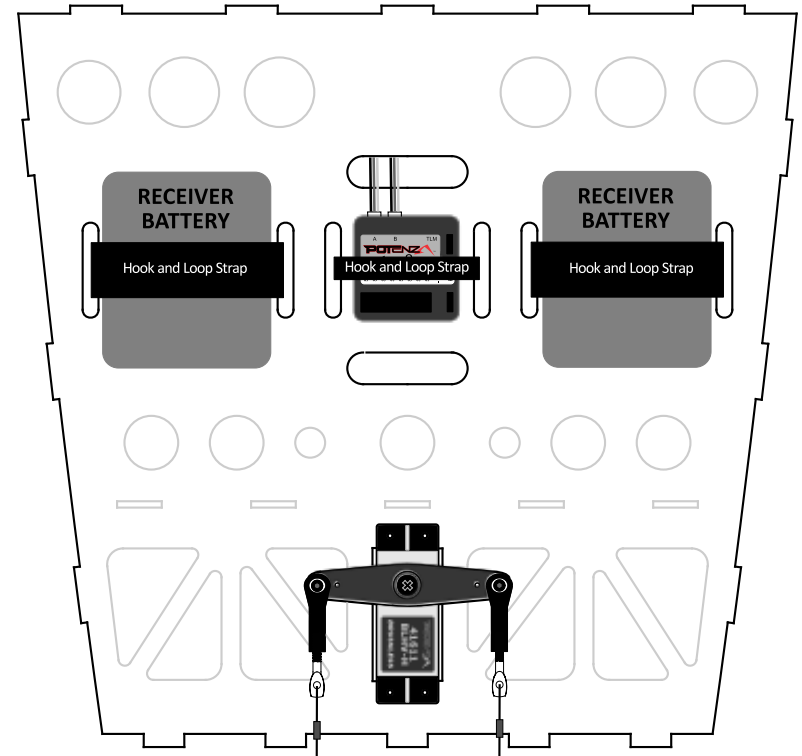

There are many different radio brands that are compatible with the AURA. From S.Bus and SRXL applications, to a simple dual remote receiver setup. Choose the application that works best for you, and reference all of our Aura information at www.flexinnovations.com/aura



RADIO SETUP

The following radio setup has been tested thoroughly during the development of the airplane, and has been determined to be the optimal starting point for your Mamba. As you become more familiar with the airplane, you may tweak the rates and expo to better suit your flying style, but these numbers will be a very good starting point.

Control throws are measured at the widest point of each control surface, unless otherwise noted. Note that aileron rates are for all ailerons, top and bottom wings.

Elevator Low Rate (25% Exponential)

UP 1-1/2-inches 39mm
DOWN 1-1/2-inches 39mm

Elevator High Rate (40% Exponential)

UP 6-7/8-inches 175mm
DOWN 6-7/8-inches 175mm

Aileron Low Rate (25% Exponential)

UP 1-1/4-inches 32mm
DOWN 1-1/4-inches 32mm

Aileron High Rate (45% Exponential)

UP 3-3/16-inches 80mm
DOWN 3-3/16-inches 80mm

Rudder Low Rate (20% Exponential)

LEFT 3-15/16-inches 100mm
RIGHT 3-15/16-inches 100mm

Rudder High Rate (45% Exponential)

LEFT 7-7/8-inches 200mm
RIGHT 7-7/8-inches 200mm

High rate should be reserved for 3D aerobatics, and low rate should be reserved for precision aerobatics. It is highly recommended that your first few flights, takeoffs and landings be done in low rate. This is a very powerful and agile airplane, and lesser experienced pilots taking off in high rate could over control the airplane and crash.

AURA TRANSMITTER CONFIGURATION GUIDE

Travel Adjust	Aileron/Elevator/Rudder	-125/+125%
	Throttle/Ch. 5 (Gear)	-100/+100%
	Ch. 6 (Aux 1)	** -100/0%
Subtrim	Transmitter Subtrim Not Allowed - Use Aura Subtrim	
Trim Levers	Verified Neutral - Only used for first flight(s) - Use Aura Quick Trim to re-center after first flight(s)	
Ch. 5 (Gear)	Assigned to 3-position switch	
Ch. 6 (Aux 1)	Assigned to 2-position switch	
Reversing	All channels set to normal. Reverse Ch. 5 and Ch. 6 to preference	
Timer	Timer set to 8:00 for first flights*	

*Flight times may vary depending on engine selection

**Different radio brands show the channel output value differently. To verify this is working properly, check the gyro function in both switch positions. Confirm that in one position, the gyro is OFF, and the gyro is ON in the other. If it does not function as previously stated, reverse the 0/100% values in your transmitter travel adjust (ATV) menu, and check for gyro OFF function again.

RANGE TESTING

Carefully follow the binding and range testing instructions included with your radio equipment. If there are any issues at all with passing the range test, please consult your radio manual to determine the appropriate solution before attempting to fly.

BEFORE FIRST FLIGHT`

Before your first flight, please go over the finished, fully-assembled model at home before going out to the flying field. The key to a successful first flight is preparation, and ensuring that your airplane is airworthy is the logical first step.

- For optimal performance of your model, balance your propeller(s) and spinner(s). Most propellers are balanced fairly well out of the bag, however, some fine-tuning can make a mediocre propeller perform great, and also point out a propeller that is out of balance. An out-of-balance propeller or spinner can wreak havoc on the electronic components in the airplane, as well as prematurely shorten the lifespan of the motor, the servos, or the model itself. A balanced propeller will be quieter, generate more thrust, and operate more efficiently than one that's not balanced.
- Recheck all linkages. Ensure that the pushrods are sufficiently threaded into ball links, ensure that all metal-to-metal connections have threadlock applied, and ensure that all controls move freely, and in the proper direction.
- Verify proper function and operation of your engine choice. Ensure that the fuel-air mixture is correct, and that the engine is making full power. If not familiar with gasoline engines, ask for the assistance of a more experienced pilot in your area, or speak with your engine manufacturer.
- Secure any loose wiring inside the fuselage, and ensure that wires do not rub or chafe.
- Ensure that all batteries (transmitter, receiver, ignition) are fully charged prior to leaving for the flying field.
- Take a few moments to assemble the airplane away from any commotion or talkative onlookers. Ensure that all connections are properly made and secured, the wing bolts are tight, and take a few minutes to plan out your first flights.
- If your engine is new, avoid prolonged full-throttle runs, and vertical climbs. Limit the first few flights to gentle throttle transitions, and start off short, gradually lengthening the flight times as you become comfortable with the performance of your engine. Six minutes is a good time to limit your first flights to. As you become more familiar with the airplane and begin to fly it in a more aggressive manner, monitor the temperature of the engine, and adjust the fuel-air mixture according to your engine manufacturer's recommendations.

REPLACEMENT PARTS

Part Number Description

FPM1100	Premier Aircraft Mamba 70cc ARF
FPM1150	Premier Aircraft Mamba 70cc ARFSV
FPM1101	Fuselage without Hatches
FPM1102	Top Wing Set (Right/Left)
FPM1103	Horizontal Stabilizer w/Elevators
FPM1104	Vertical Stabilizer w/Rudder
FPM1105	Cowling with Hardware
FPM1106	Canopy Hatch Set
FPM1107	Aluminum Landing Gear
FPM1108	Wheel Pants with Hardware
FPM1109	Carbon Wing Tubes (2)
FPM1110	Tail Wheel with Hardware
FPM1111	Main Wheel and Axle Set
FPM1112	Pushrod Linkage/ Control Horn Set
FPM1113	Hardware Set
FPM1115	Decal Sheet
FPM1117	Shark Tooth Set
FPM1119	Interplane Strut Set
FPM1120	Wing Center Section (Top Wing)
FPM1121	Laser Cut Wood Parts
FPM1122	Bottom Wing Set (Right/Left)
FPM1123	Fuel Tank with Accessories

OPTIONAL ACCESSORIES

FPM1114	Wing Bag Set (Main Wings)
FPZAURA08	Aura 8 Flight Control System
FPZDS41611BLHV-H	Potenza Brushless DS41611BLHV-H Servo
FPZDS19410TGHV	Potenza DS19410TGHV Digital Servo
FPZA0001	Potenza 25 Tooth Aluminum Single Servo Arm, 1.25 in
FPZA0002	Potenza 25 Tooth Aluminum Double Servo Arm, 2.5 in
FPM1124	15mm Aluminum Standoffs (1/4" Hole) Set of 4
FPZA1010	Digital Battery Analyzer
FPZMC0080	Potenza C80 80W Charger
FPMA0001A	Flex Innovations Hat - White
FPMA0001B	Flex Innovations Hat - Gray
FPMA0002AXL	Premier Aircraft Shirt, White Base, XL
FPMA0002BXL	Premier Aircraft Shirt, Gray Base, XL
FPMA0002CXL	Potenza Shirt, White Base, XL
FPMA0002DXL	Potenza Shirt, Gray Base, XL

ENJOY YOUR

MAMBA



This is called the "Crow Airbrake"; great for slowing downlines and making amazing short field landings, all while still maintaining gyro corrections with the Aura 8! This is only made possible with the Aura 8, and is pre-programmed in our Mamba model file!

LIMITED WARRANTY

Warranty Coverage

Flex Innovations, Inc. and its authorized resellers ("Flex") warrant to the original purchaser that the product purchased (the "Product") it will be free from defects in materials and workmanship at the date of purchase.

Outside of Coverage

The warranty is not transferable and does not cover:

- (a) Products with more than 45 days after purchased date.
- (b) Damage due to acts of God, accident, misuse, abuse, negligence, commercial use, or due to improper use, installation, operation or maintenance.
- (c) Modification of or to any part of the Product.
- (d) Product not compliant with applicable technical regulations.
- (e) Shipping damage.
- (f) Cosmetic damage.

OTHER THAN THE EXPRESS WARRANTY ABOVE, FLEX MAKES NO OTHER WARRANTY OR REPRESENTATION, AND HEREBY DISCLAIMS ANY AND ALL IMPLIED WARRANTIES, INCLUDING, WITHOUT LIMITATION, THE IMPLIED WARRANTIES OF NONINFRINGEMENT, MERCHANTABILITY AND FITNESS FOR A PARTICULAR PURPOSE. THE PURCHASER ACKNOWLEDGES THAT THEY ALONE HAVE DETERMINED THAT THE PRODUCT WILL SUITABLY MEET THE REQUIREMENTS OF THE PURCHASER'S INTENDED USE.

Purchaser's Solution

Flex's sole obligation and purchaser's sole and exclusive remedy shall be that Flex will, at its option, either (i) service, or (ii) replace, any Product determined by Flex to be defective. Flex reserves the right to inspect any and all Product(s) involved in a warranty claim. Service or replacement decisions are at the sole discretion of Flex. Proof of purchase is required for all warranty claims. **SERVICE OR REPLACEMENT AS PROVIDED UNDER THIS WARRANTY IS THE PURCHASER'S SOLE AND EXCLUSIVE REMEDY.**

Limitation of Liability

FLEX SHALL NOT BE LIABLE FOR SPECIAL, INDIRECT, INCIDENTAL OR CONSEQUENTIAL DAMAGES, LOSS OF PROFITS OR PRODUCTION OR COMMERCIAL LOSS IN ANY WAY, REGARDLESS OF WHETHER SUCH CLAIMS IS BASED IN CONTRACT, WARRANTY, TORT, NEGLIGENCE, STRICT LIABILITY OR ANY OTHER THEORY OF LIABILITY, EVEN IF FLEX HAS BEEN ADVISED OF THE POSSIBILITY OF SUCH DAMAGES.

Further, in no event shall the liability of Flex exceed the individual price of product on which liability is asserted. As Flex has no control over use, setup, assembly, modification or misuse, no liability shall be assumed nor accepted for any resulting damage or injury. By the act of use, setup or assembly, the user accepts all resulting liability. If you as the purchaser or user are not prepared to accept the liability associated with the use of the Product, purchaser is advised to return the Product immediately in new and unused condition to the place of purchase.

Law

These terms are governed by Florida law (without regard to conflict of law principals). This warranty gives you specific legal rights, and you may also have other rights which vary from state to state. FLEX RESERVES THE RIGHT TO MODIFY THIS WARRANTY AT ANY TIME WITHOUT PRIOR NOTICE.

Questions & Assistance

Contact Us By:

E-Mail - support@flexinnovations.com
Phone - 1 (866) 310-3539

Inspection or Services

If this Product needs to be inspected or serviced and is compliant in the region you live and use the Product in, please contact your regional Flex authorized reseller. Pack the Product securely using a shipping carton. Please note that original boxes need to be included, but are not designed to withstand the rigors of shipping without additional protection. Ship via a carrier that provides tracking and insurance for lost or damaged parcels, as Flex is not responsible for merchandise until it arrives and is accepted at our facility.

Warranty Requirements

For Warranty consideration, you must include your original sales receipt verifying the proof of purchase date. Provided any warranty conditions have been met, your Product will be replaced free of charge. Shipping charges are as follows: to Flex by customer, Flex out is by Flex. Service or replacement decisions are at the sole discretion of Flex.

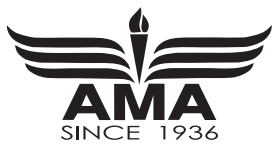

Academy of Model Aeronautics National Model Aircraft Safety Code

Effective January 1, 2015

- A. GENERAL:** A model aircraft is a non-human-carrying aircraft capable of sustained flight in the atmosphere. It may not exceed limitations of this code and is intended exclusively for sport, recreation, education and/or competition. All model flights must be conducted in accordance with this safety code and any additional rules specific to the flying site.
- Model aircraft will not be flown:
 - In a careless or reckless manner.
 - At a location where model aircraft activities are prohibited.
 - Model aircraft pilots will:
 - Yield the right of way to all human-carrying aircraft.
 - See and avoid all aircraft and a spotter must be used when appropriate. (AMA Document #540-D.)
 - Not fly higher than approximately 400 feet above ground level within three (3) miles of an airport without notifying the airport operator.
 - Not interfere with operations and traffic patterns at any airport, heliport or seaplane base except where there is a mixed use agreement.
 - Not exceed a takeoff weight, including fuel, of 55 pounds unless in compliance with the AMA Large Model Airplane program. (AMA Document 520-A.)
 - Ensure the aircraft is identified with the name and address or AMA number of the owner on the inside or affixed to the outside of the model aircraft. (This does not apply to model aircraft flown indoors.)
 - Not operate aircraft with metal-blade propellers or with gaseous boosts except for helicopters operated under the provisions of AMA Document #555.
 - Not operate model aircraft while under the influence of alcohol or while using any drug that could adversely affect the pilot's ability to safely control the model.
 - Not operate model aircraft carrying pyrotechnic devices that explode or burn, or any device which propels a projectile or drops any object that creates hazard to persons or property
- Exceptions:**
- Free Flight fuses or devices that burn producing smoke and are securely attached to the model aircraft during flight.
 - Rocket motors (using solid propellant) up to a G-series size may be used provided they remain attached to the model during flight. Model rockets may be flown in accordance with the National Model Rocketry Safety Code but may not be launched from model aircraft.
 - Officially designated AMA Air Show Teams (AST) are authorized to use devices and practices as defined within the Team AMA Program Document. (AMA Document #718.)
- Not operate a turbine-powered aircraft, unless in compliance with the AMA turbine regulations. (AMA Document #510-A.)
- Model aircraft will not be flown in AMA sanctioned events, air shows, or model demonstrations unless:
 - The aircraft, control system and pilot skills have successfully demonstrated all maneuvers intended or anticipated prior to the specific event.
 - An inexperienced pilot is assisted by an experienced pilot.
 - When and where required by rule, helmets must be properly worn and fastened. They must be OSHA, DOT, ANSI, SNELL or NOCSAE approved or comply with comparable standards.
- B. RADIO CONTROL (RC)**
- All pilots shall avoid flying directly over unprotected people, vessels, vehicles or structures and shall avoid endangerment of life and property of others.
 - A successful radio equipment ground-range check in accordance with manufacturer's recommendations will be completed before the first flight of a new or repaired model aircraft.
 - At all flying sites a safety line(s) must be established in front of which all flying takes place. (AMA Document #706)
 - Only personnel associated with flying the model aircraft are allowed at or in front of the safety line.
 - At airshows or demonstrations, a straight safety line must be established.

- An area away from the safety line must be maintained for spectators. Intentional flying behind the safety line is prohibited.
- RC model aircraft must use the radio-control frequencies currently allowed by the Federal Communications Commission (FCC). Only individuals properly licensed by the FCC are authorized to operate equipment on Amateur Band frequencies.
 - RC model aircraft will not knowingly operate within three (3) miles of any pre-existing flying site without a frequency-management agreement. (AMA Documents #922 and #923.)
With the exception of events flown under official AMA Competition Regulations, excluding takeoff and landing, no powered model may be flown outdoors closer than 25 feet to any individual, except for the pilot and the pilot's helper(s) located at the flightline.
Under no circumstances may a pilot or other person touch an outdoor model aircraft in flight while it is still under power, except to divert it from striking an individual.
RC night flying requires a lighting system providing the pilot with a clear view of the model's attitude and orientation at all times. Hand-held illumination systems are inadequate for night flying operations.
 - The pilot of an RC model aircraft shall:
 - Maintain control during the entire flight, maintaining visual contact without enhancement other than by corrective lenses prescribed for the pilot.
 - Fly using the assistance of a camera or First-Person-View (FPV) only in accordance with the procedures outlined in AMA Document #550.
 - Fly using the assistance of autopilot or stabilization system only in accordance with the procedures outlined in AMA Document #560.
- C. FREE FLIGHT**
- Must be at least 100 feet downwind of spectators and automobile parking when the model aircraft is launched.
 - Launch area must be clear of all individuals except mechanics, officials, and other fliers.
 - An effective device will be used to extinguish any fuse on the model aircraft after the fuse has completed its function.
- D. CONTROL LINE**
- The complete control system (including the safety thong where applicable) must have an inspection and pull test prior to flying.
 - The pull test will be in accordance with the current Competition Regulations for the applicable model aircraft category.
 - Model aircraft not fitting a specific category shall use those pull-test requirements as indicated for Control Line Precision Aerobatics.
 - The flying area must be clear of all utility wires or poles and a model aircraft will not be flown closer than 50 feet to any above-ground electric utility lines.
The flying area must be clear of all nonessential participants and spectators before the engine is started.
 - started.

If you are not an AMA member, please consider joining. Founded in 1936 and open to anyone interested in model aviation, the AMA is the governing body for model aviation in the United States and sanctions over 2,000 competitions annually. Membership in the AMA provides liability insurance coverage, protects modelers' rights and interests, and is required to fly at most of the 2,700+ R/C sites nationwide.

Academy of Model Aeronautics
5161 East Memorial Drive
Muncie, IN 47302-9252
Toll Free (800) 435-9262
Fax (765) 741-0057

www.modelaircraft.org

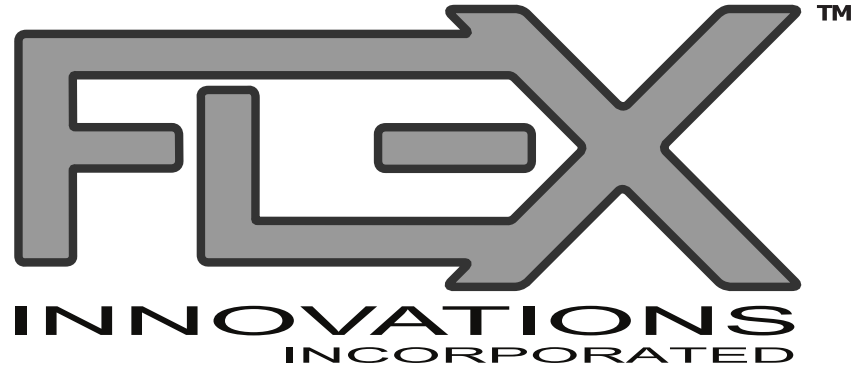

©2016 Flex Innovations, Inc.
Premier Aircraft™, Potenza™, and Top Value RC™ are trademarks or registered trademarks of Flex Innovations, Inc.

Tru-Turn® is a registered trademark of Romco Manufacturing, Inc.
Desert Aircraft™ is a trademark or registered trademark of Desert Aircraft
UltraCote® is a registered trademark of Horizon Hobby, LLC.
Oracover® is a registered trademark of LANITZ-PRENA FOLIEN FACTORY GmbH