



ULTIMATE

Biplane 20cc ARF

Code: SEA389

ASSEMBLY MANUAL



Specifications:

| | | |
|--|-----------------------------------|-----------|
| Wingspan----- | 54.3 in----- | 138 cm. |
| Length----- | 59.4 in----- | 151 cm. |
| Wing area----- | 992 sq.in----- | 64 sq.dm. |
| Weight----- | 10.6 lbs----- | 4.8 kg. |
| Engine----- | 20 - 26cc. | |
| Motor 2000 - 270watt / ESC 85A - 110A/ Lipo 6s - 8s. | | |
| Electric propeller 17x8 - 19x10. | | |
| Radio----- | 6 channels with 6 digital servos. | |



INTRODUCTION

Thank you for choosing the **ULTIMATE Biplane 20cc ARF** ARTF by **SG MODELS**. The **ULTIMATE Biplane 20cc ARF** was designed with the intermediate/advanced sport flyer in mind. It is a semi scale airplane which is easy to fly and quick to assemble. The airframe is conventionally built using balsa, plywood to make it stronger than the average ARTF, yet the design allows the aeroplane to be kept light. You will find that most of the work has been done for you already. The motor mount has been fitted and the hinges are pre-installed. Flying the **ULTIMATE Biplane 20cc ARF** is simply a joy.

This instruction manual is designed to help you build a great flying aeroplane. Please read this manual throughly before starting assembly of your **ULTIMATE Biplane 20cc ARF**. Use the parts listing below to indentify all parts.

WARNING

Please be aware that this aeroplane is not a toy and if assembled or used incorrectly it is capable of causing injury to people or property. WHEN YOU FLY THIS AEROPLANE YOU ASSUME ALL RISK & REPONSIBILITY.

If you are inexperienced with basic R/C flight we strongly recommend you contact your R/C supplier and join your local R/C model Flying Club. R/C Model Flying Clubs offer a variety of training procedures designed to help the new pilot on his way to successful R/C flight. They will also be able to advise on any insurance and safety regulations that may apply.

KIT CONTENTS

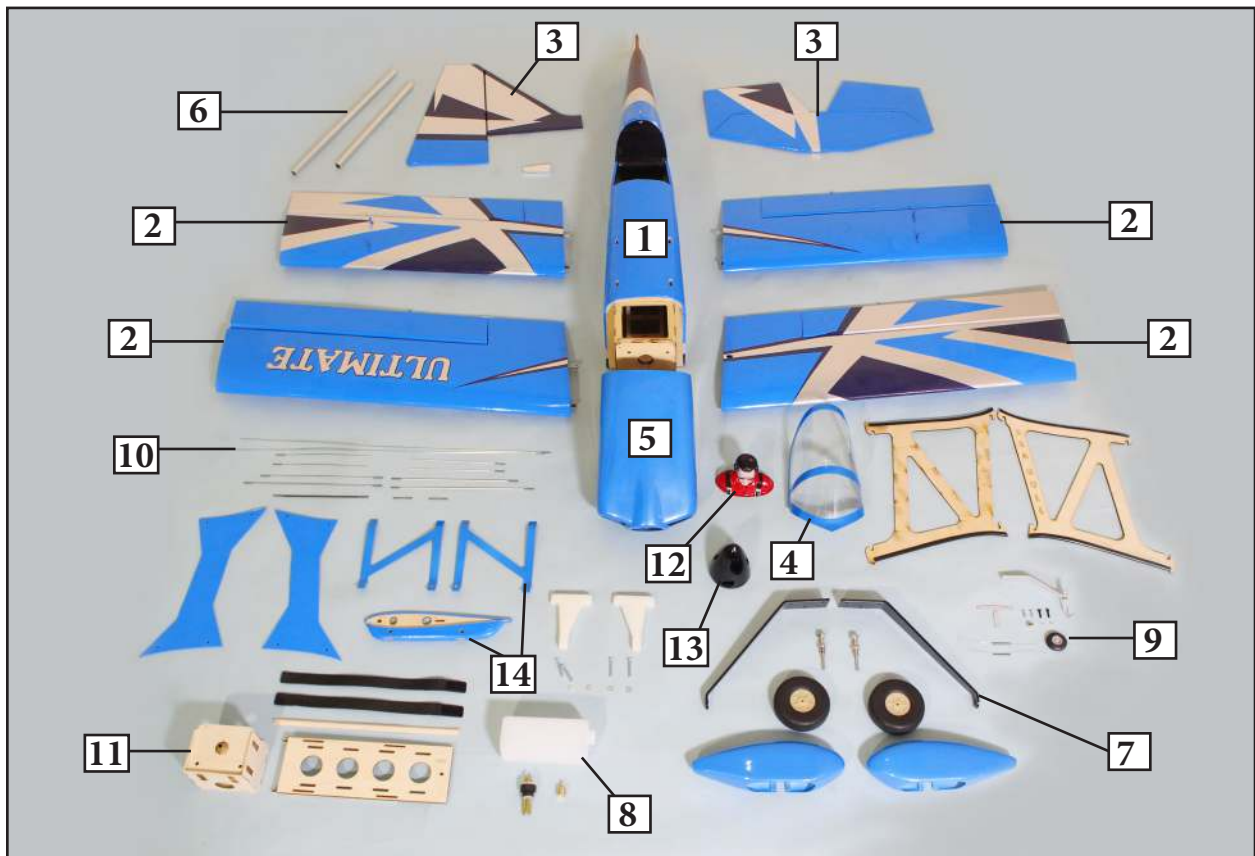

KIT CONTENTS

SEA389 ULTIMATE Biplane 20cc ARF

1. Fuselage
2. Wing set (2)
3. Tail set (2)
4. Canopy
5. Cowling
6. Wing tube
7. landing gear
8. Fuel tank
9. Tail wheel
10. Pushrod
11. Ep Motor box
12. Pilot
13. Spinner
14. Cabane Strut

ADDITIONAL ITEMS REQUIRED

- 20-26cc gasoline engine.
- Computer radio 6 channel with 6 servos.
- Glow plug to suit engine.
- Propeller to suit engine 17x8-19x10.
- Protective foam rubber for radio system.

TOOLS & SUPPLIES NEEDED

- Thin cyanoacrylate glue.
- Medium cyanoacrylate glue.
- 30 minute epoxy.
- 5 minute epoxy.
- Hand or electric drill.
- Assorted drill bits.
- Modelling knife.
- Straight edge ruler.
- 2mm ball driver.
- Phillips head screwdriver.
- 220 grit sandpaper.
- 90° square or builder's triangle.
- Wire cutters.
- Masking tape & T-pins.
- Thread-lock.
- Paper towels.

HINGING THE AILERON

Note : *The control surfaces, including the ailerons, elevators, and rudder, are prehinged with hinges installed, but the hinges are not glued in place. It is imperative that you properly adhere the hinges in place per the steps that follow using a high-quality thin C/A glue.*

Carefully remove the aileron from one of the wing panels. Note the position of the hinges.

1.



Remove each hinge from the wing panel and aileron and place a T-pin in the center of each hinge. Slide each hinge into the wing panel until the T-pin is snug against the wing panel. This will help ensure an equal amount of hinge is on either side of the hinge line when the aileron is mounted to the aileron.

2.

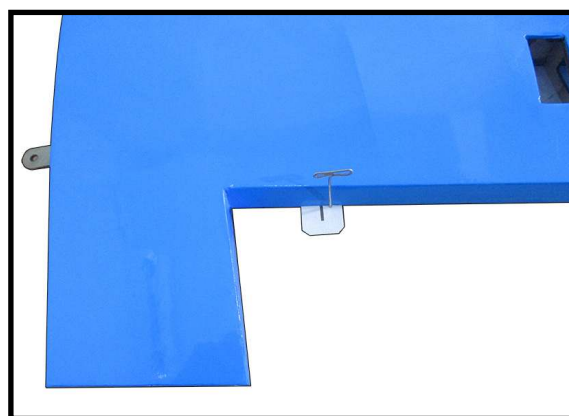

Slide the wing panel on the aileron until there is only a slight gap. The hinge is now centered on the wing panel and aileron. Remove the T-pins and snug the aileron against the wing panel. A gap of 1/64" or less should be maintained between the wing panel and aileron.

Deflect the aileron and completely saturate each hinge with thin C/A glue. The ailerons front surface should lightly contact the wing during this procedure. Ideally, when the hinges are glued in place, a 1/64" gap or less will be maintained throughout the length of the aileron to the wing panel hinge line.

NOTE : The hinge is constructed of a special material that allows the C/A to wick or penetrate and distribute throughout the hinge, securely bonding it to the wood structure of the wing panel and aileron.

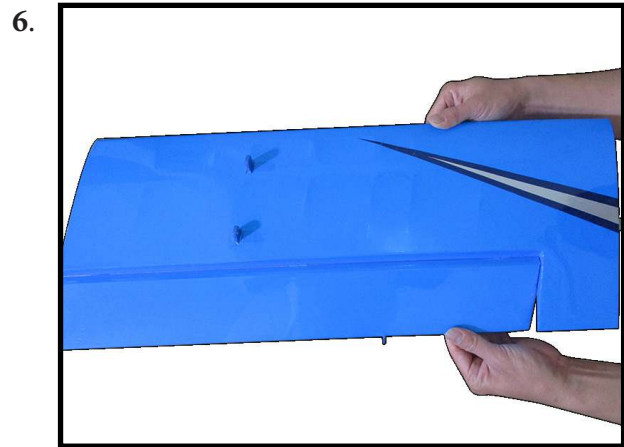
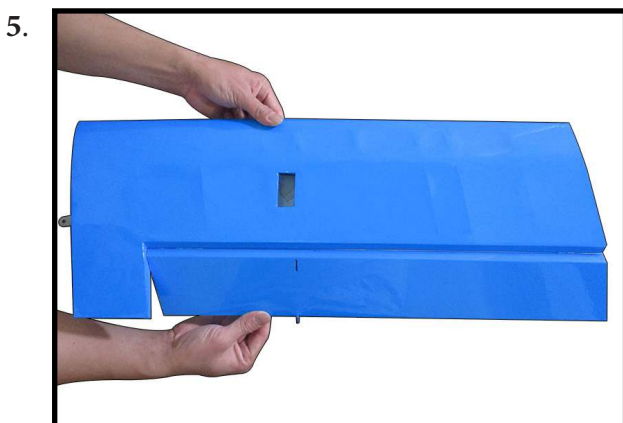
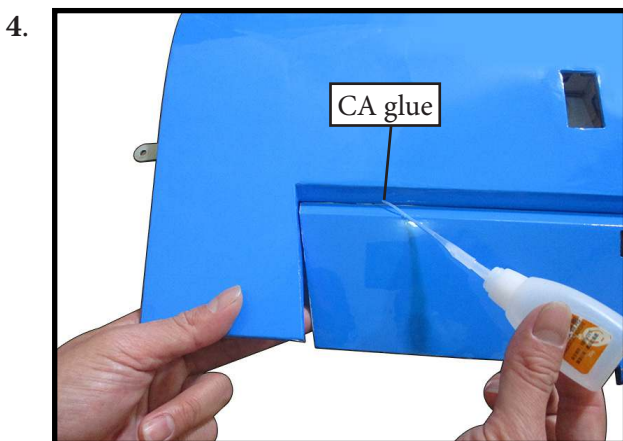
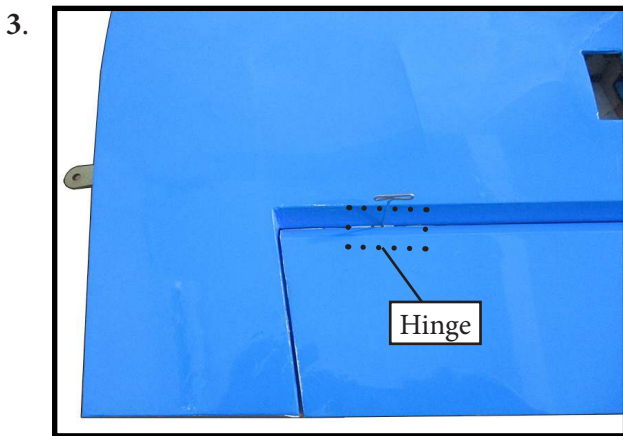

Turn the wing panel over and deflect the aileron in the opposite direction from the opposite side. Apply thin C/A glue to each hinge, making sure that the C/A penetrates into both the aileron and wing panel.

Using C/A remover/debonder and a paper towel, remove any excess C/A glue that may have accumulated on the wing or in the aileron hinge area.

Repeat this process with the other wing panel, securely hinging the aileron in place.

After both ailerons are securely hinged, firmly grasp the wing panel and aileron to make sure the hinges are securely glued and cannot be pulled out. Do this by carefully applying medium pressure, trying to separate the aileron from the wing panel. Use caution not to crush the wing structure.

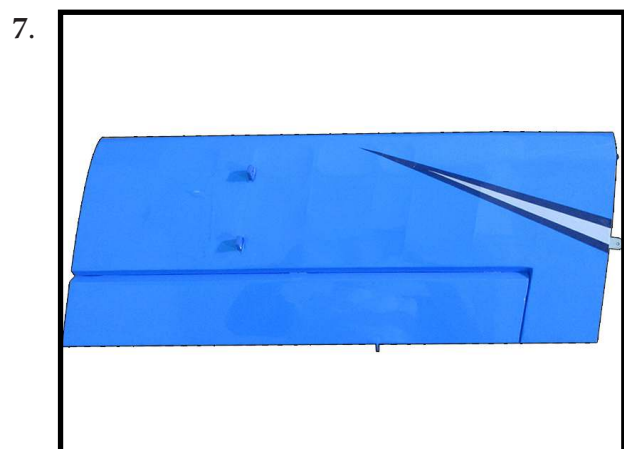

Note : Work the aileron up and down several times to "work in" the hinges and check for proper movement.

INSTALL THE AILERONS CONTROL HORN

Locate the aileron control horns. The taller control horn is used for the ailerons, and the shorter horn for the flaps.

1.

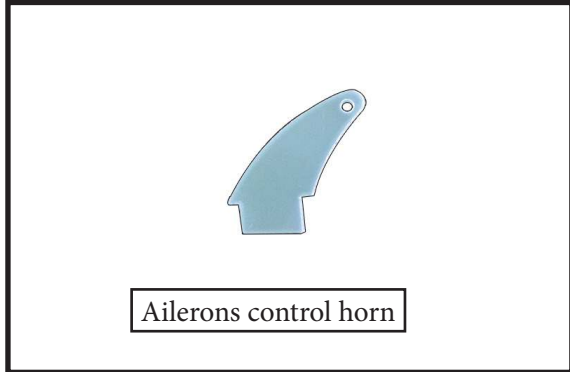

Use sandpaper to scuff the bottom of the aileron and flap control horns. Use a paper towel and isopropyl alcohol to remove any oils or debris from the control horns.

2.

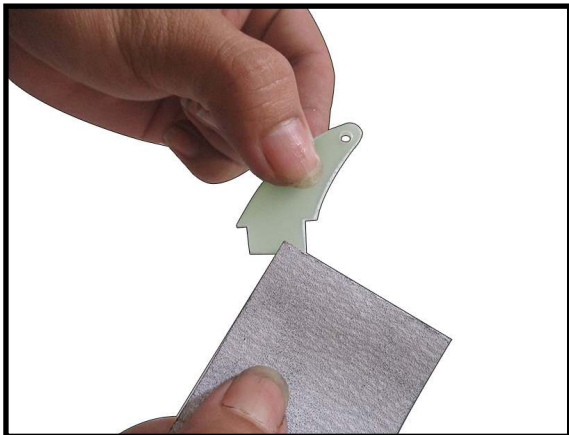

Check the fit of the control horns to the aileron and flap. They should rest flush against the control surface as shown.

3.

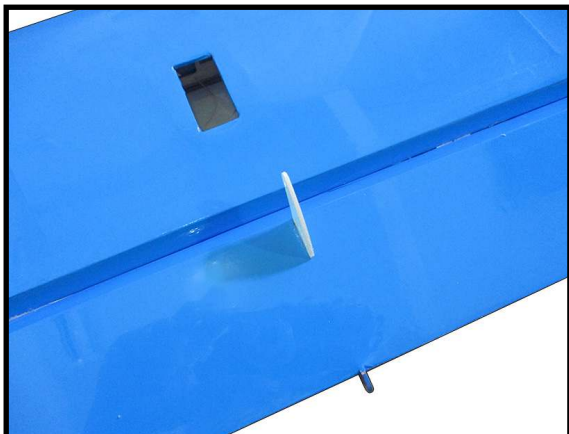

Place low-tack tape 1/32 inch (1mm) from the control horn slot. This will prevent epoxy from getting on the control surface when the control horns are glued in place.

4.

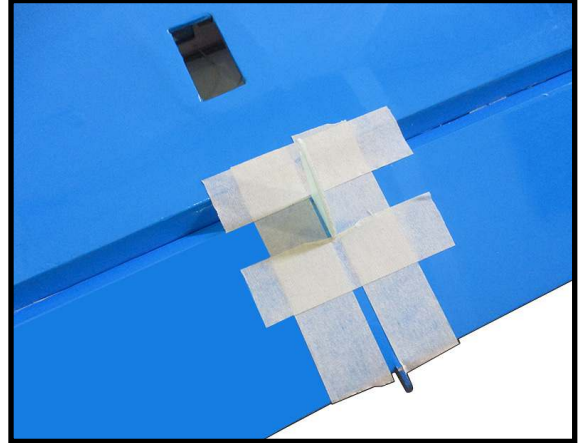

Remove the control horns from the control surfaces. Apply epoxy to the slot in the aileron and flap. Make sure the epoxy gets into the slot for a good bond between the surfaces and control horn.

5.

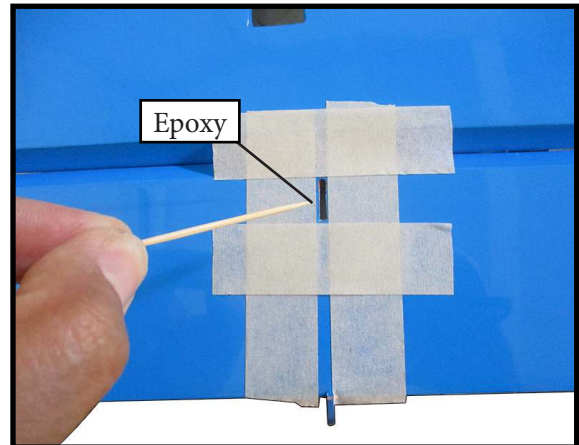

Apply epoxy to the area of the control horns that fit into the slots. Use enough epoxy so the control horns will be fully bonded to the fixed surfaces.

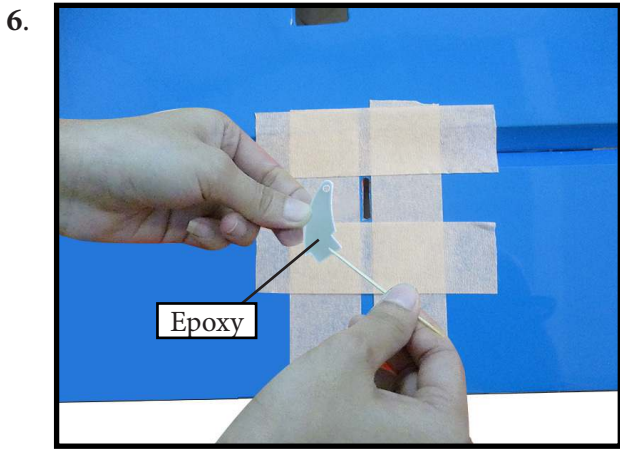

Before the epoxy fully cures, remove the tape from around the control horn. This will allow the epoxy to flow around the control horn, creating a small fillet between the control horn and surface for a finished look and secure bond.

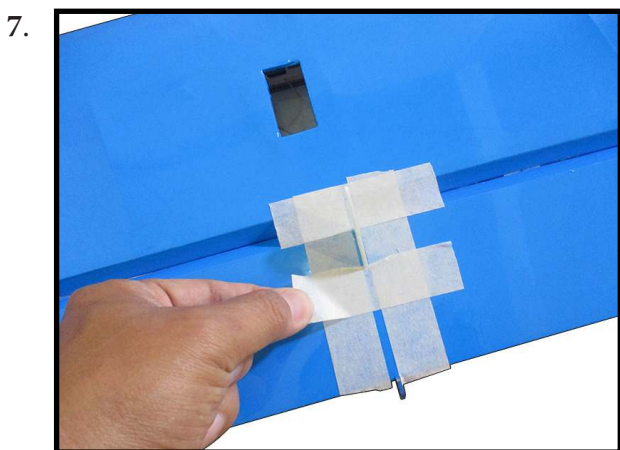

INSTALLING THE AILERON SERVOS

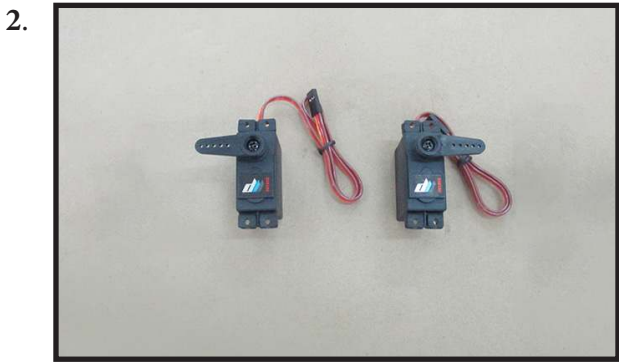
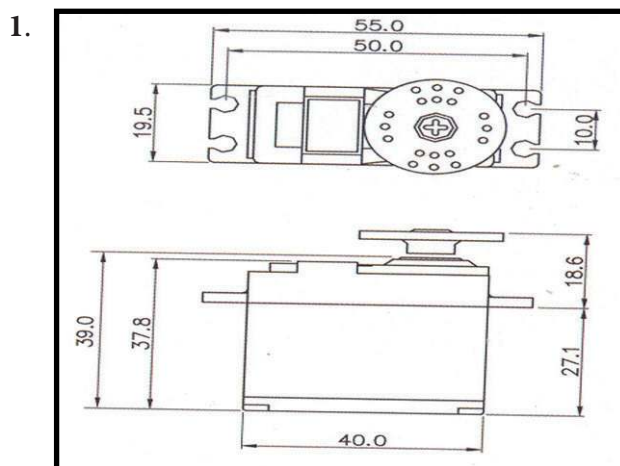

Maximum Servo spec.
Torque : 126.6 oz-in (9.11 kg-cm) @ 6.0V;
 178 oz-in (12.82 kg-cm) @ 7.4V; 248 oz-in (17.86 kg-cm) @ 8.4V

Install the rubber grommets and brass collets onto the aileron servo. Test fit the servo into the aileron servo mount.

 Because the size of servos differ, you may need to adjust the size of the precut opening in the mount. The notch in the sides of the mount allow the servo lead to pass through.

Use dental floss to secure the connection so they cannot become unplugged.

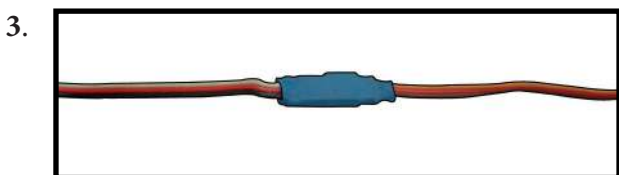

Using a small weight (Weighted fuel pickup works well) and thread, feed the string through the wing as indicated.

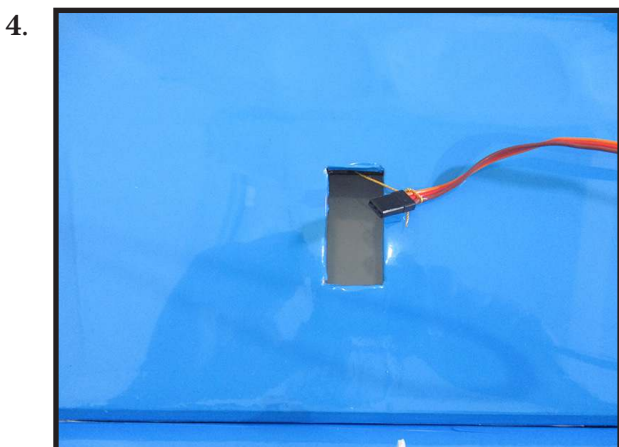

Attach servo lead to the aileron servo. Attach the string to the servo lead and carefully thread it through the wing. Once you have threaded the lead through the wing, remove the string so it can be used for the other servo lead.

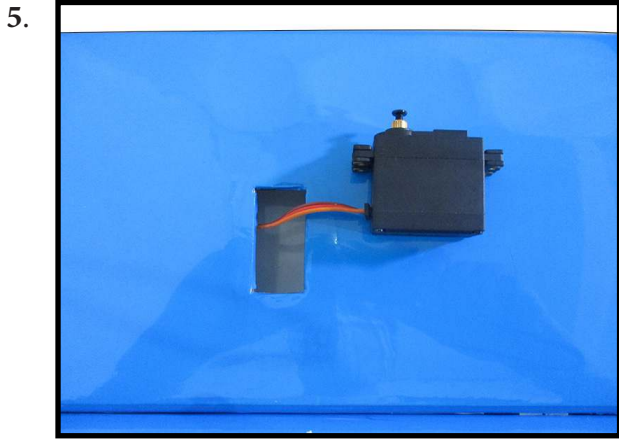

Tape the servo lead to the wing to prevent it from falling back into the wing.

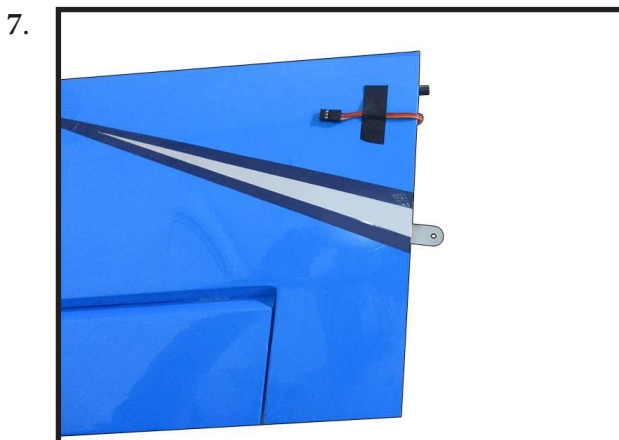

Reinstall the servo into the servo mount and secure the servo in place using the wood screws provided with your radio system.

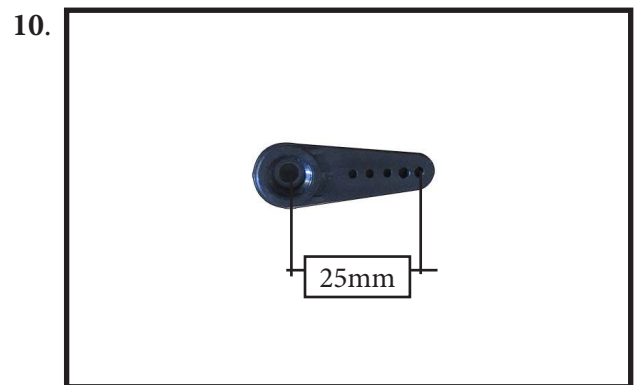

Repeat the procedure for the other wing half.

INSTALLING THE AILERON PUSHROD

Please study images below.

1.

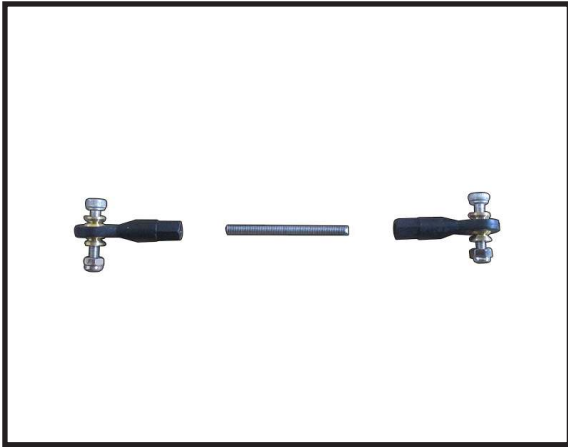

2.



3.

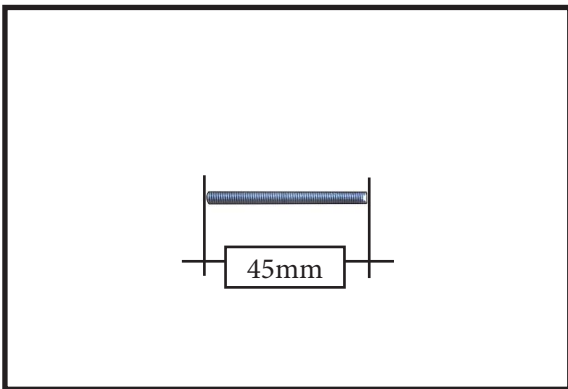

4.



5.

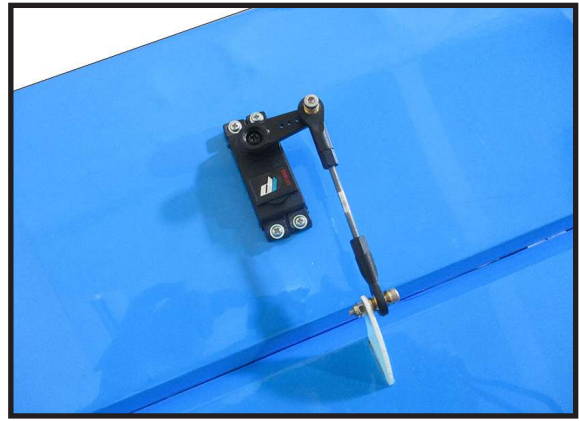

INSTALL HINGE FOR STABILIZER AND ELEVATOR

Please study images below.

1.

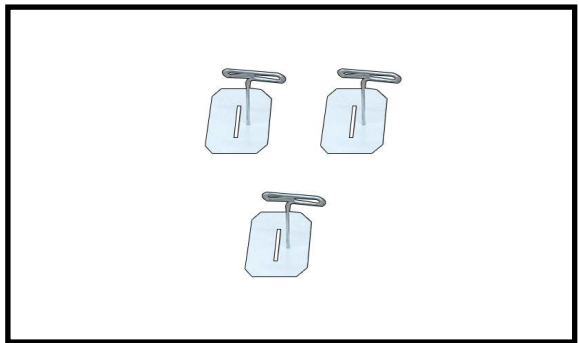

2.

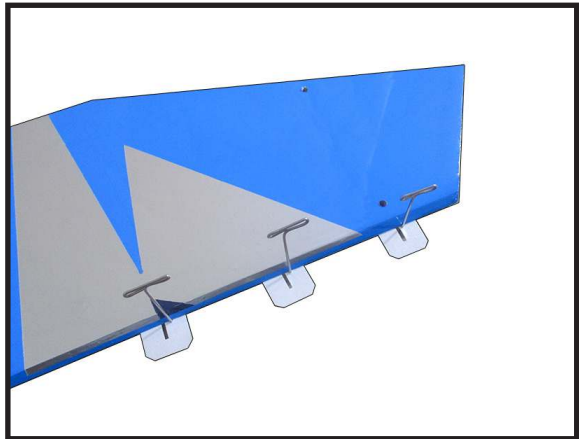

3.

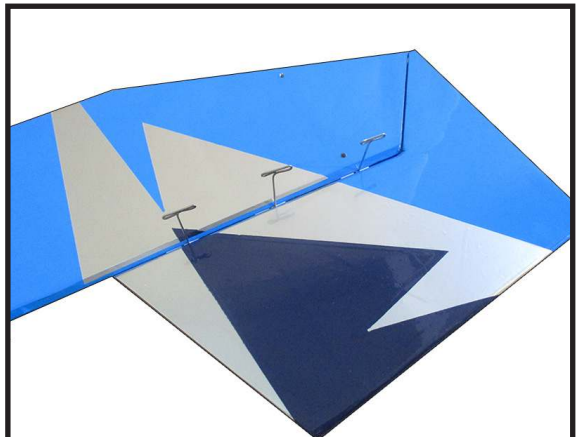

4.

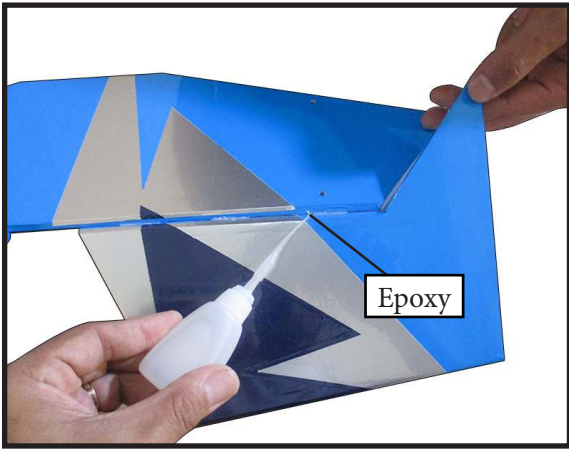

5.

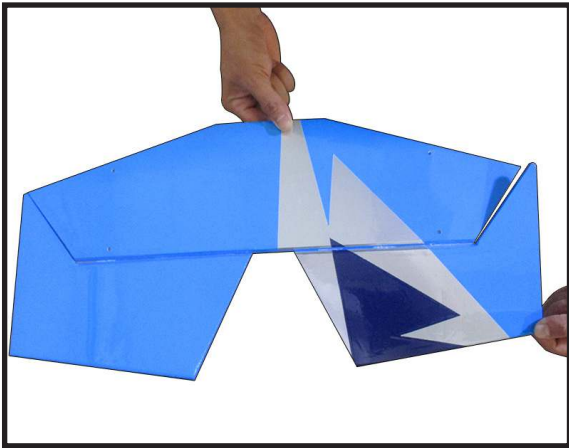

6.

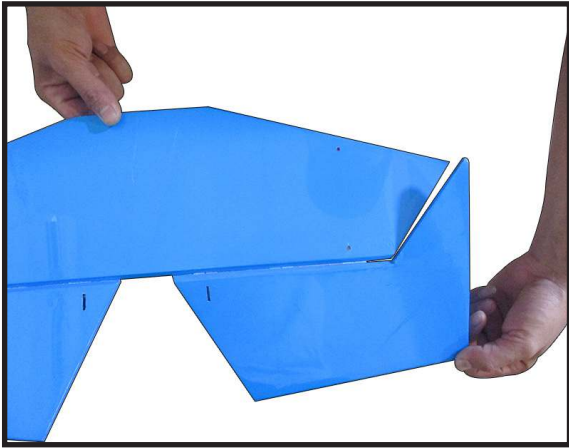

7.

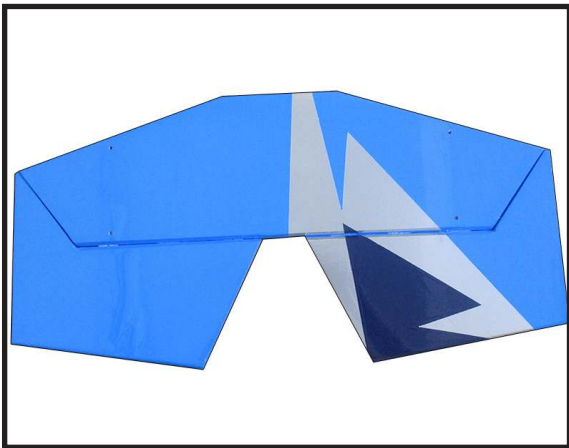

INSTALL ELEVATOR CONTROL HORN

1.

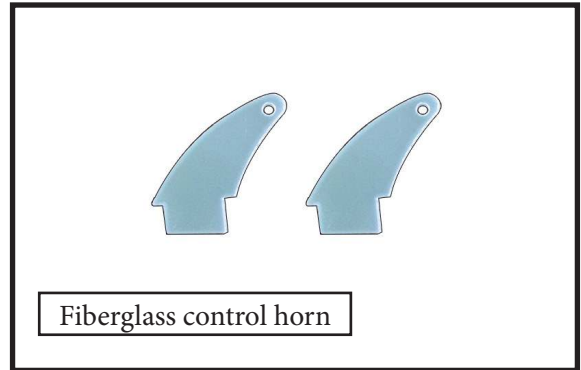

2.

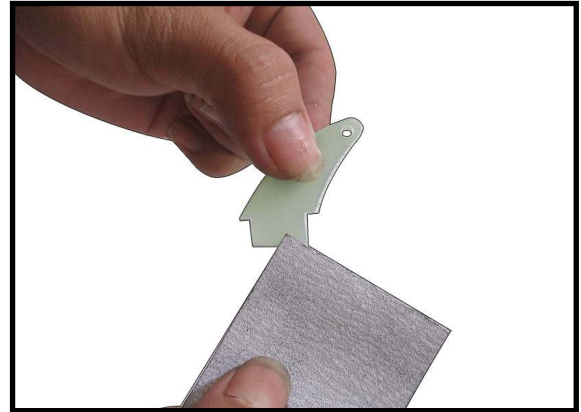

3.

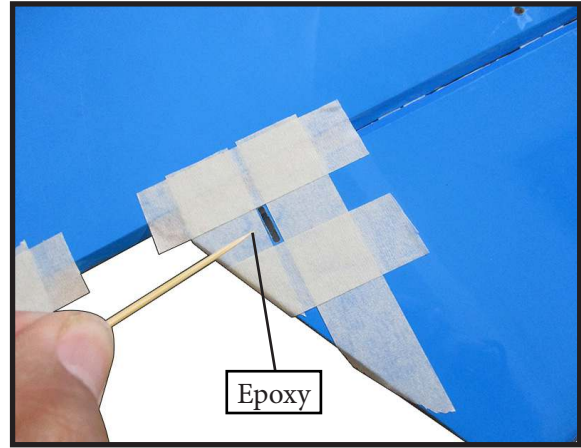

4.

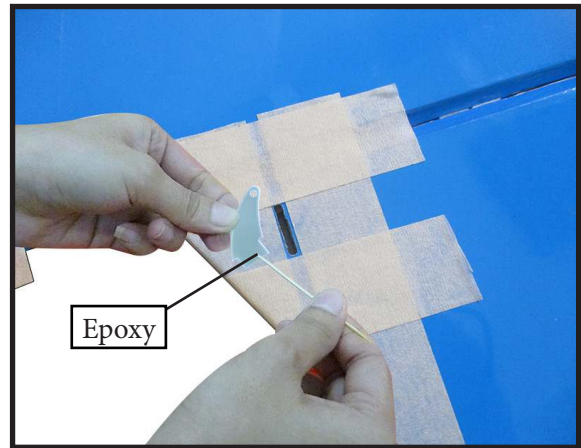

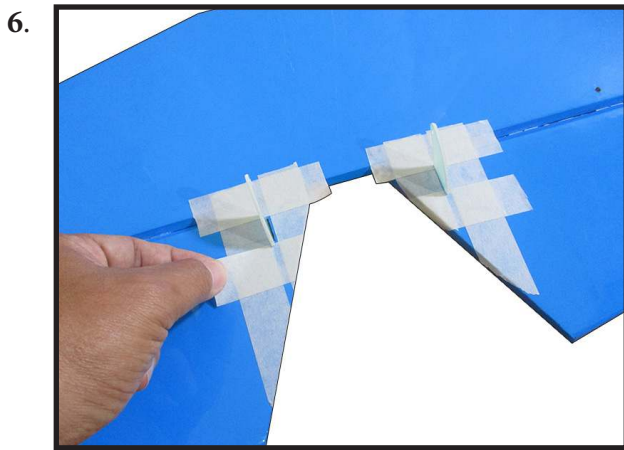
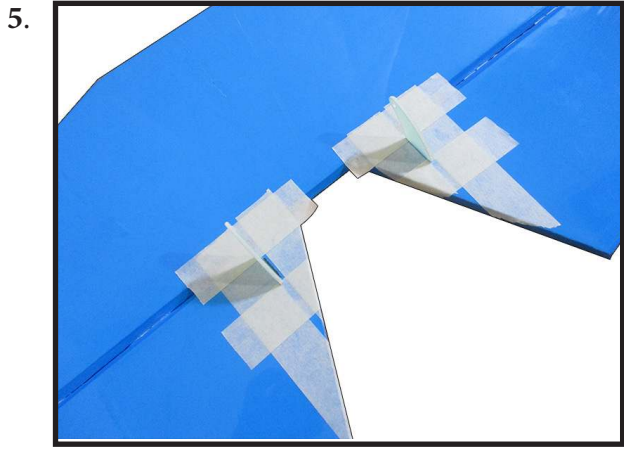

Maximum Servo spec.
Torque : 126.6 oz-in (9.11 kg-cm) @ 6.0V;
178 oz-in (12.82 kg-cm) @ 7.4V; 248 oz-in (17.86 kg-cm) @ 8.4V

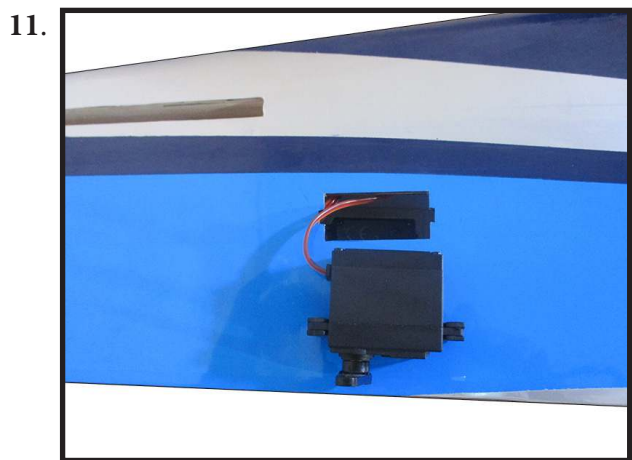
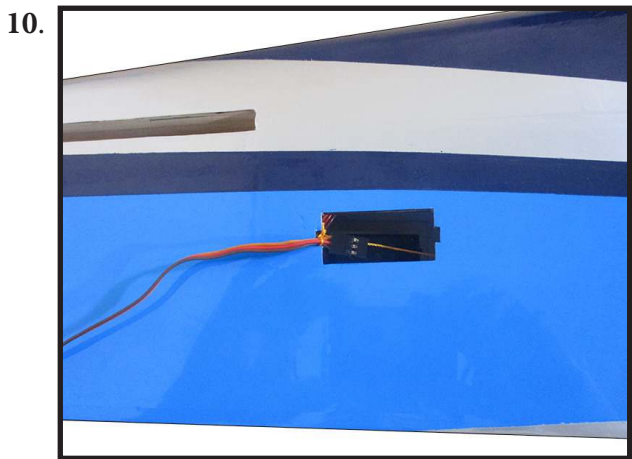

12.

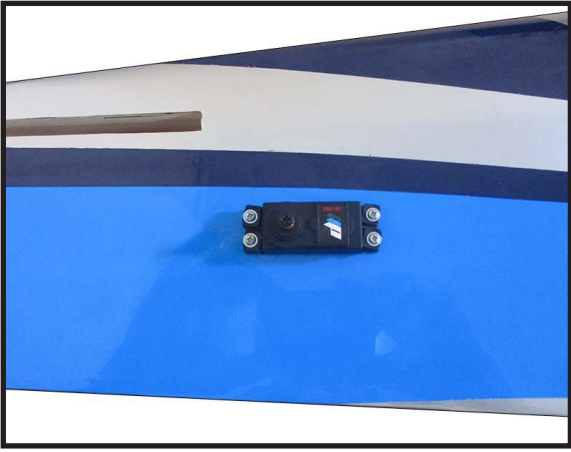

16.

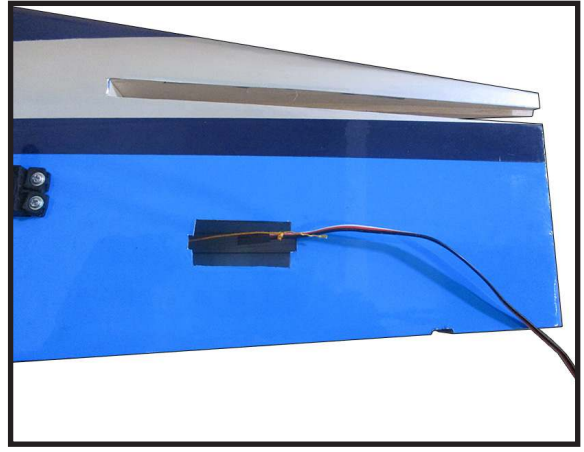

13.



17.



14.



18.



15.



19.



INSTALLING THE HORIZONTAL STABILIZER

Using a ruler and a pen, locate the centerline of the horizontal stabilizer, at the trailing edge, and place a mark. Use a triangle and extend this mark, from back to front, across the top of the stabilizer. Also extend this mark down the back of the trailing edge of the stabilizer.

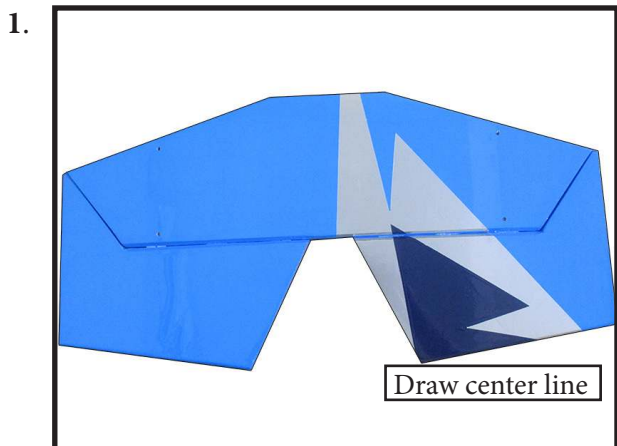

Using a modeling knife, carefully remove the covering at mounting slot of horizontal stabilizer (both side of fuselage).

Slide the stabilizer into place in the precut slot in the rear of the fuselage. The stabilizer should be pushed firmly against the front of the slot.

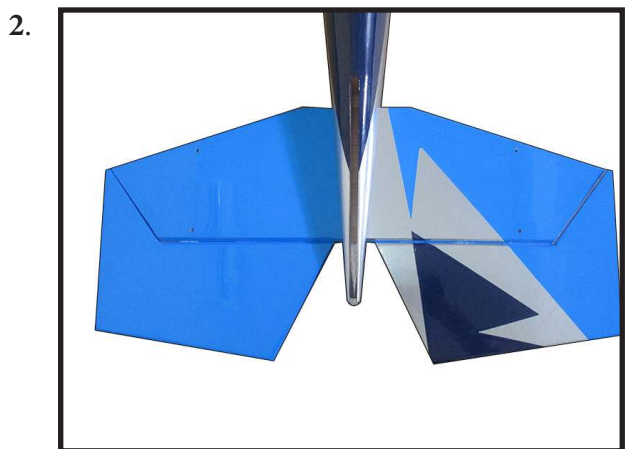

With the stabilizer held firmly in place, use a pen and draw lines onto the stabilizer where it and the fuselage sides meet. Do this on both the right and left sides and top and bottom of the stabilizer.

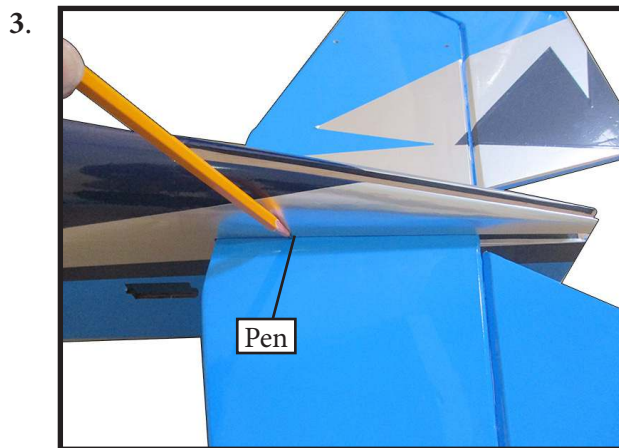

Remove the stabilizer. Using the lines you just drew as a guide, carefully remove the covering from between them using a modeling knife.

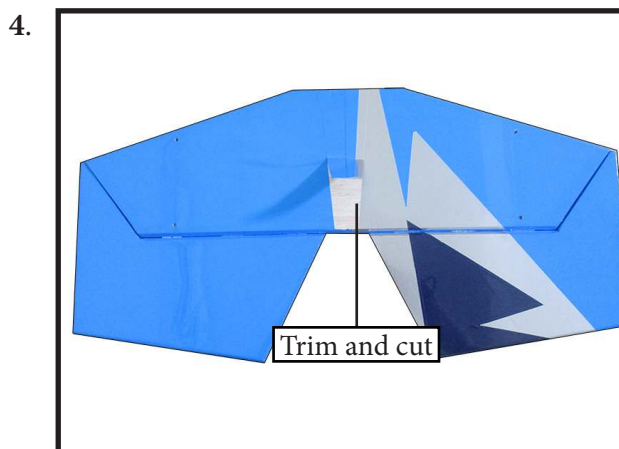

! *When cutting through the covering to remove it, cut with only enough pressure to only cut through the covering itself. Cutting into the balsa structure may weaken it.*

Using a modeling knife, carefully remove the covering that overlaps the stabilizer mounting platform sides in the fuselage. Remove the covering from both the top and the bottom of the platform sides.

5.

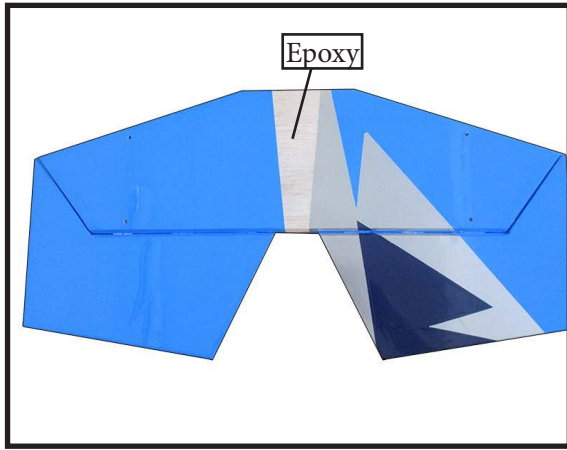

When you are sure that everything is aligned correctly, mix up a generous amount of 30 Minute Epoxy. Apply a thin layer to the top and bottom of the stabilizer mounting area and to the stabilizer mounting platform sides in the fuselage. Slide the stabilizer in place and realign. Double check all of your measurements once more before the epoxy cures. Hold the stabilizer in place with T-pins or masking tape and remove any excess epoxy using a paper towel and rubbing alcohol.

6.

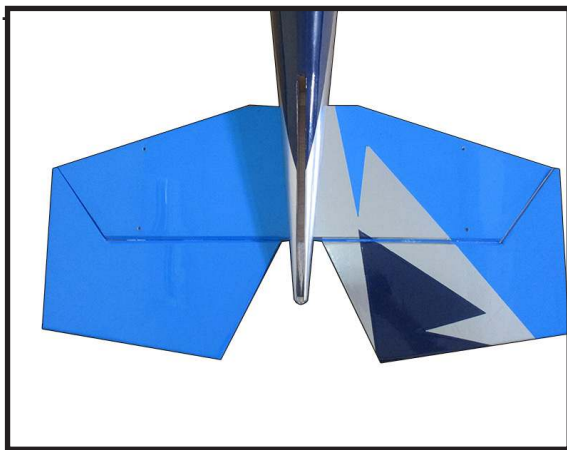

After the epoxy has fully cured, remove the masking tape or T-pins used to hold the stabilizer in place. Carefully inspect the glue joints. Use more epoxy to fill in any gaps that may exist that were not filled previously and clean up the excess using a paper towel and rubbing alcohol.

7.

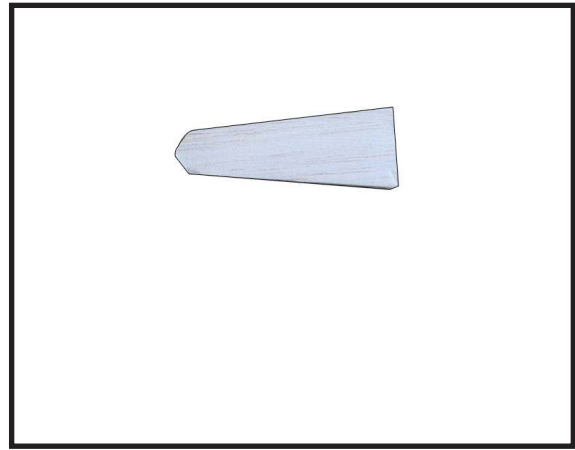

8.

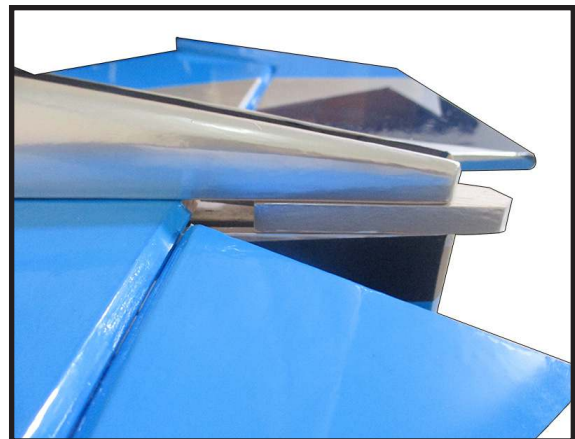

HINGING THE RUDDER

Glue the top three rudder hinges in place using the same techniques used to hinge the elevator.

The lower hinge will be glued when the fin/rudder assembly is attached to the fuselage.

1.

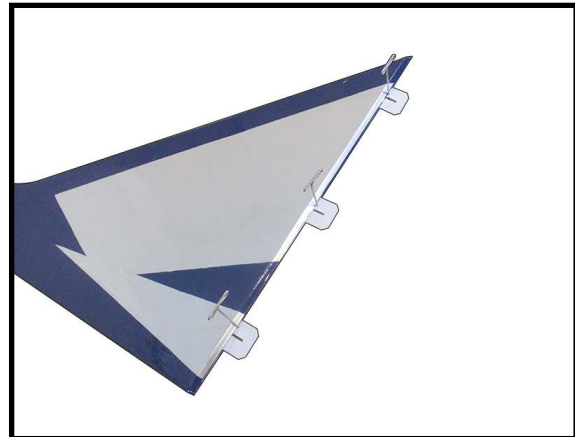

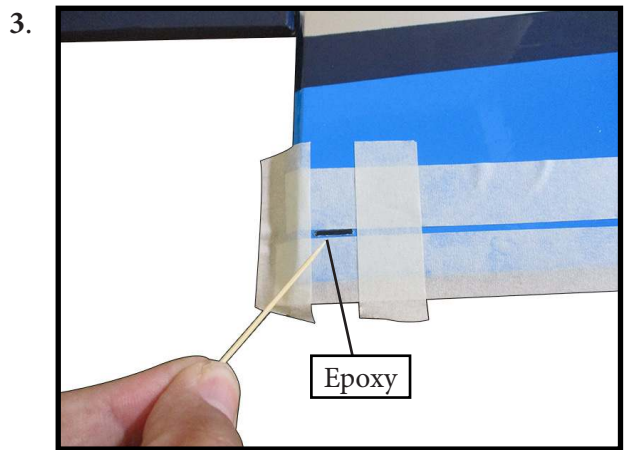
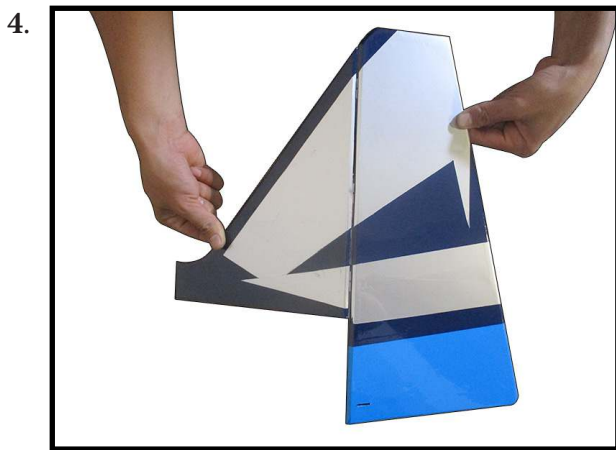
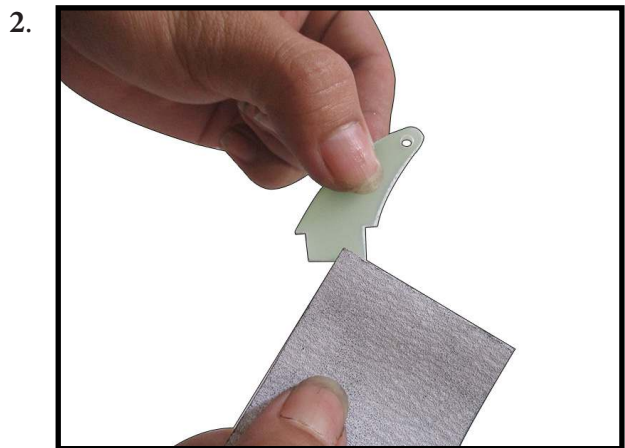
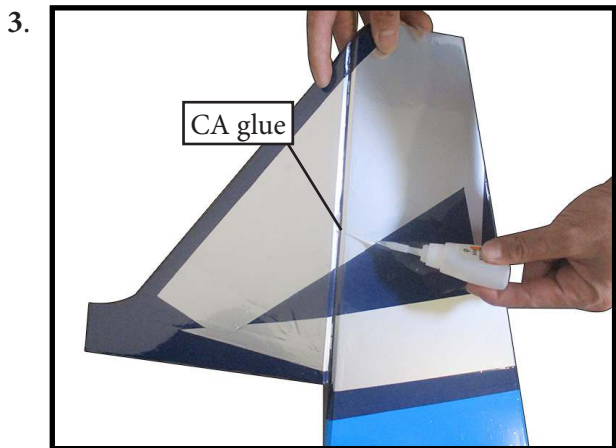
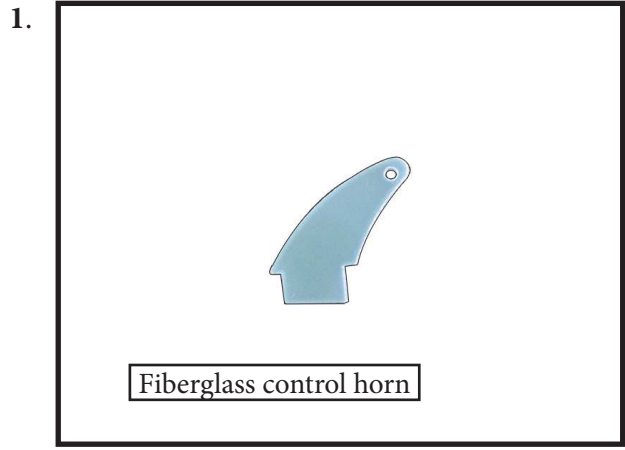

INSTALL RUDDER CONTROL HORN

Repeat steps to install the rudder control horn as same as steps done for elevator.

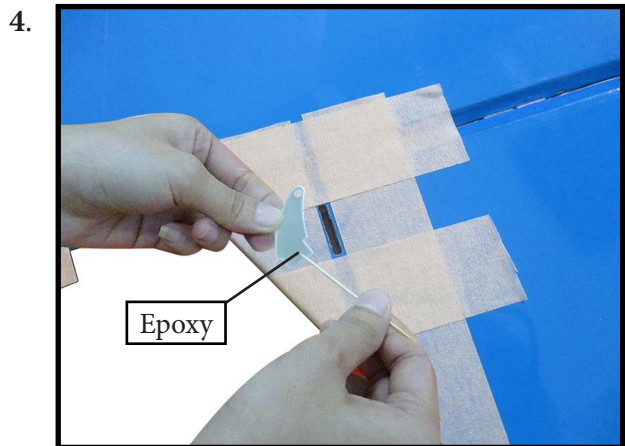

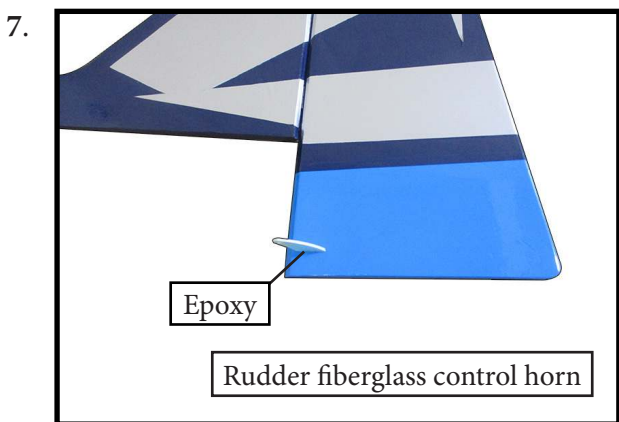
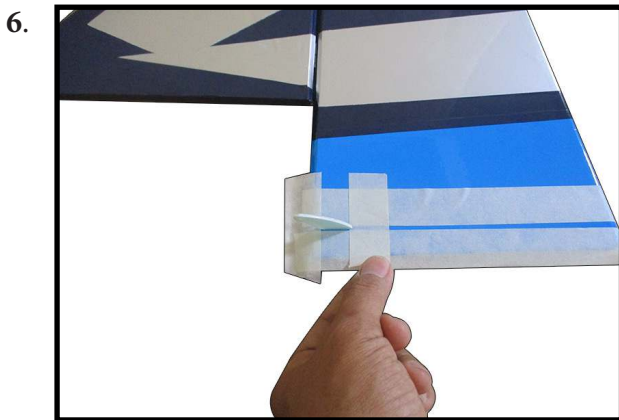
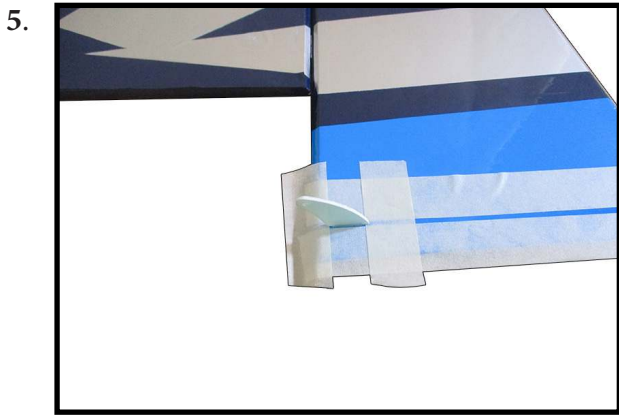

**VERTICAL STABILIZER
INSTALLATION**



Using a modeling knife, remove the covering from over the precut hinge slot cut into the lower rear portion of the fuselage. This slot accepts the lower rudder hinge.

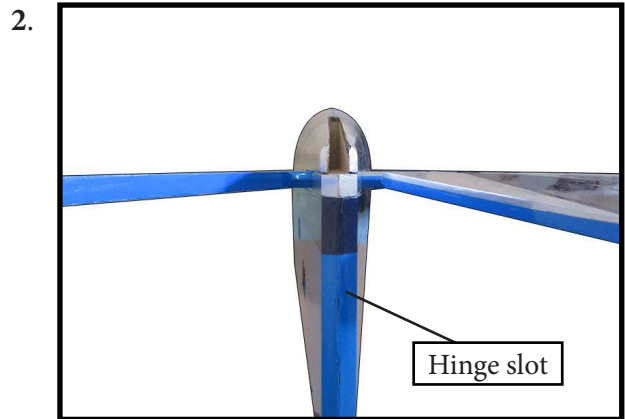

Slide the vertical stabilizer into the slot in the top of the fuselage. The rear edge of the stabilizer should be flush with the rear edge of the fuselage and the lower rudder hinge should engage the precut hinge slot in the lower fuselage. The bottom edge of the stabilizer should also be firmly pushed against the top of the horizontal stabilizer.

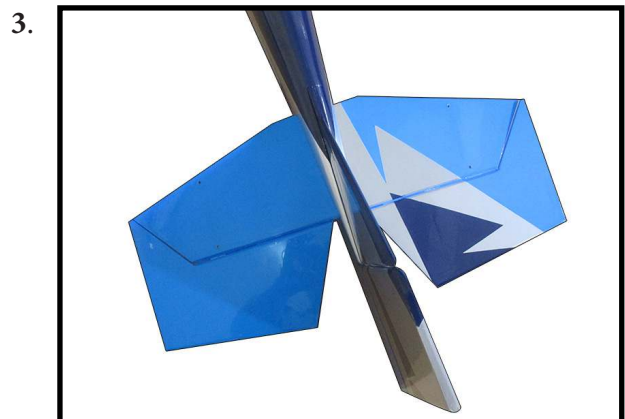

While holding the vertical stabilizer firmly in place, use a pen and draw a line on each side of the vertical stabilizer where it meets the top of the fuselage.

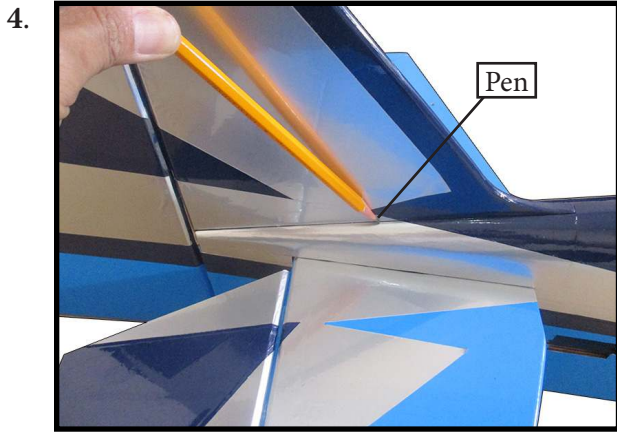

Remove the stabilizer. Using a modeling knife, remove the covering from below the lines you drew. Also remove the covering from the bottom edge of the stabilizer and the bottom and top edges of the filler block. Leave the covering in place on the sides of the filler block.

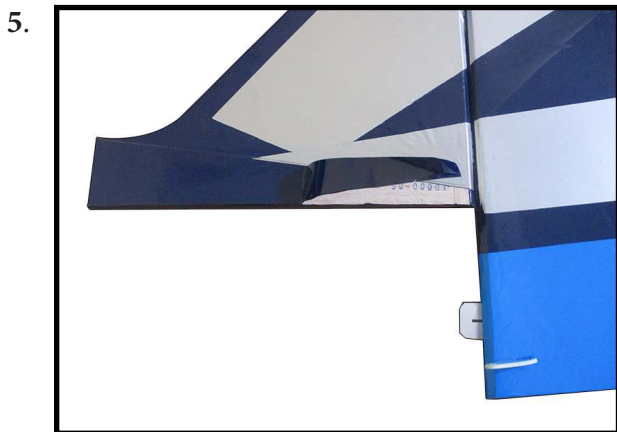

Slide the vertical stabilizer back in place. Using a triangle, check to ensure that the vertical stabilizer is aligned 90° to the horizontal stabilizer.

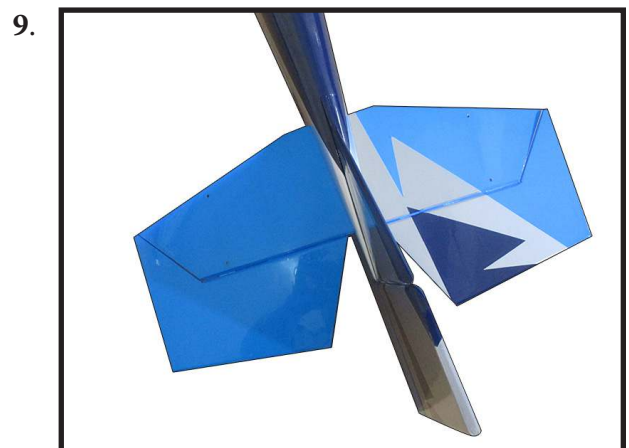
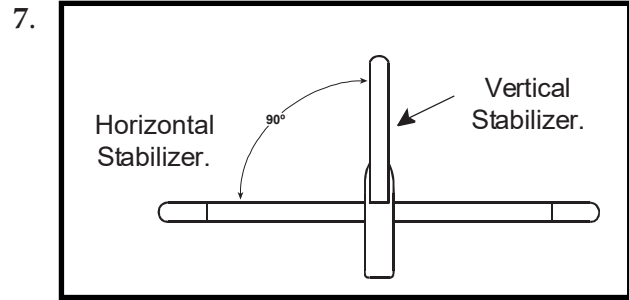

When you are sure that everything is aligned correctly, mix up a generous amount of Flash 30 Minute Epoxy. Apply a thin layer to the mounting slot and to bottom of the vertical stabilizer mounting area. Apply epoxy to the bottom and top edges of the filler block and to the lower hinge also. Set the stabilizer in place and realign. Double check all of your measurements once more before the epoxy cures. Hold the stabilizer in place with T-pins or masking tape and remove any excess epoxy using a paper towel and rubbing alcohol. Allow the epoxy to fully cure before proceeding.

ELEVATOR PUSHROD INSTALLATION

1.



2.

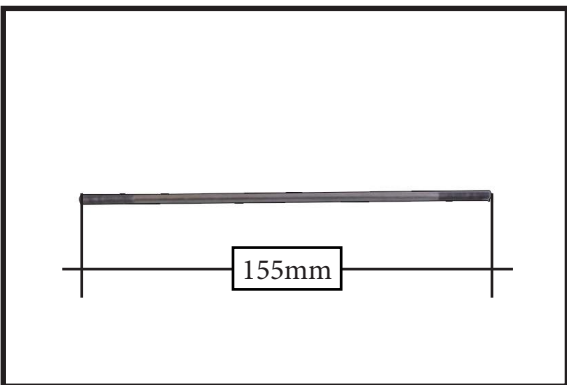

3.



4.



RUDDER PUSHROD INSTALLATION

Locate items necessary to install rudder pushrod.

1.



2.

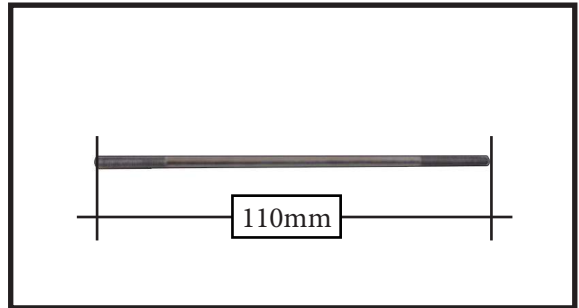

3.



4.



TAILWHEEL INSTALLATION

Locate items necessary to install tailwheel.

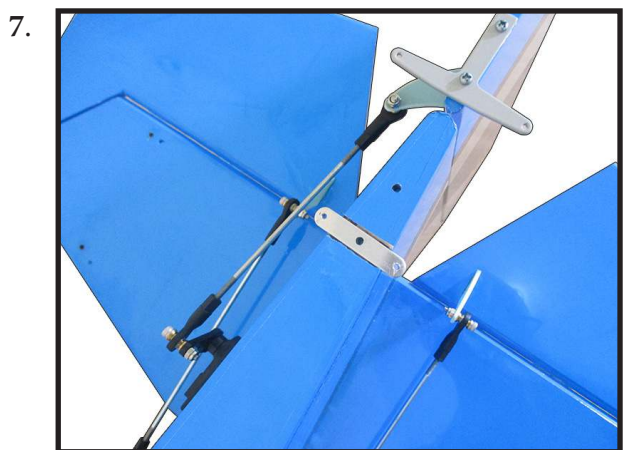
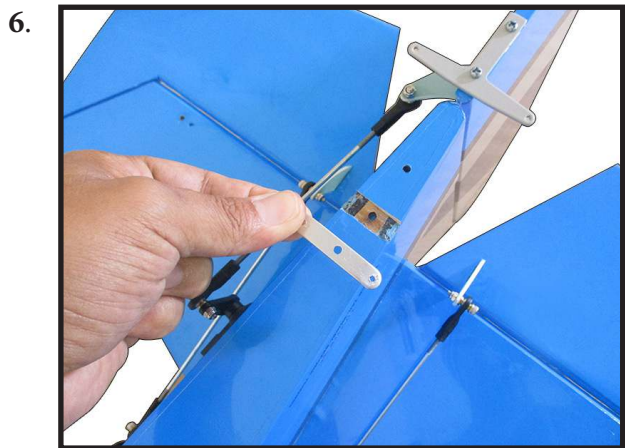
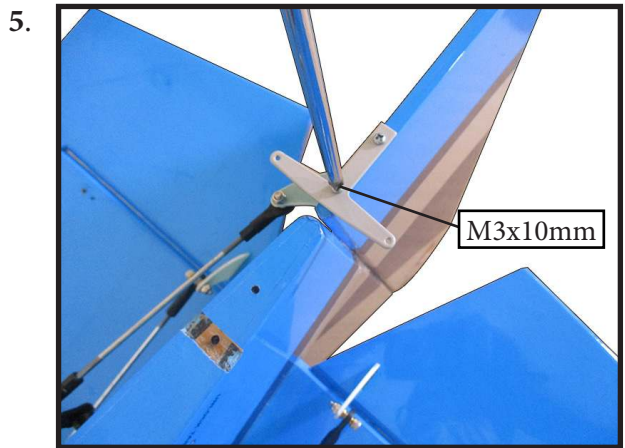
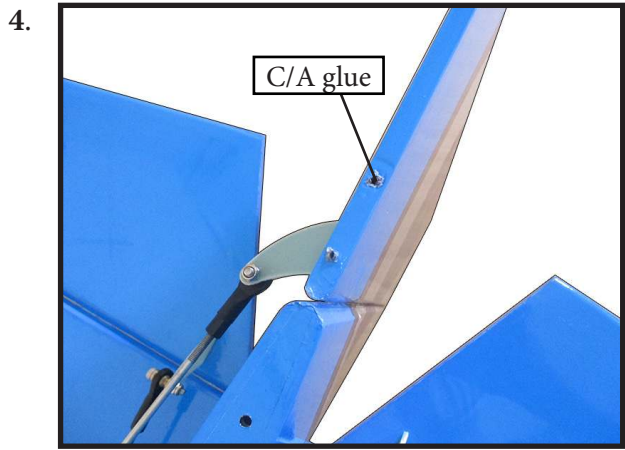
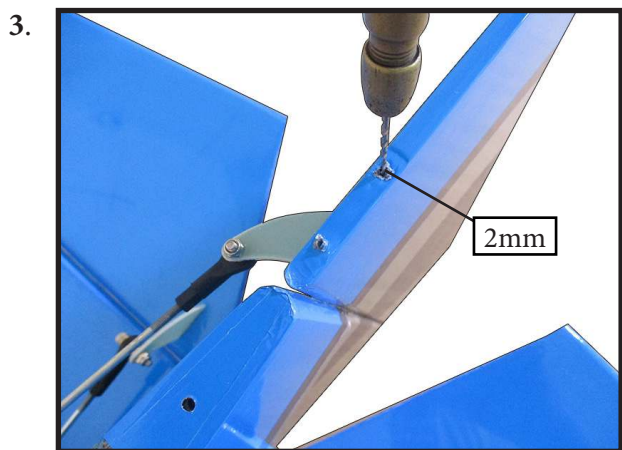
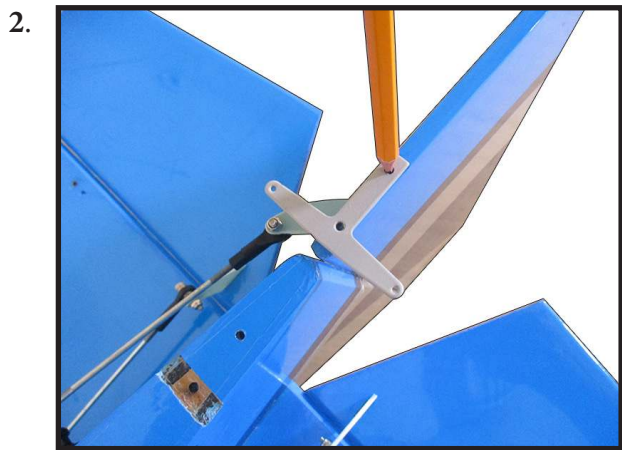
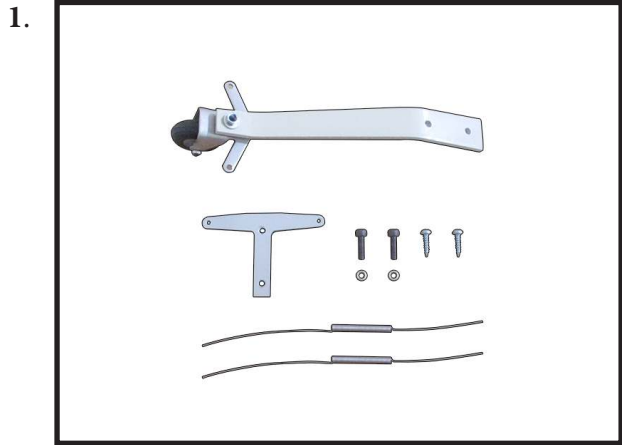

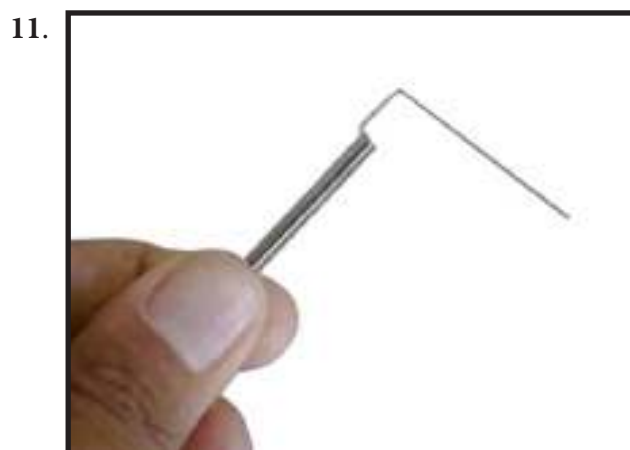
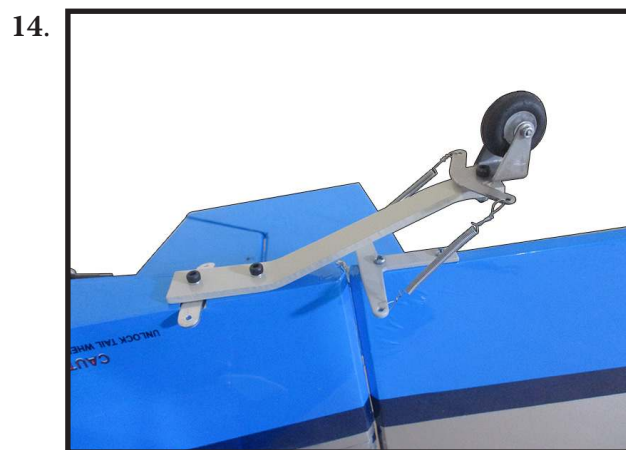
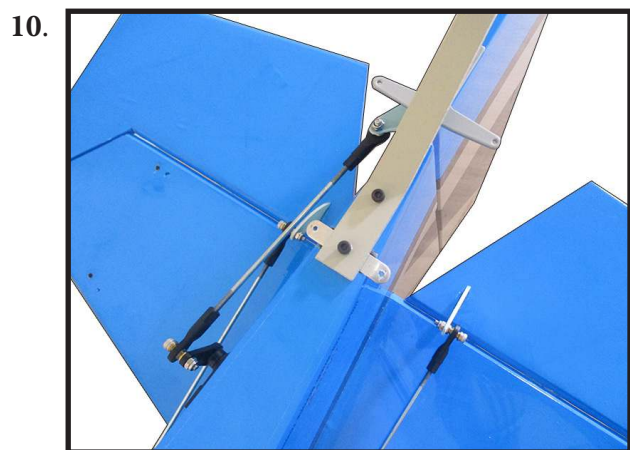
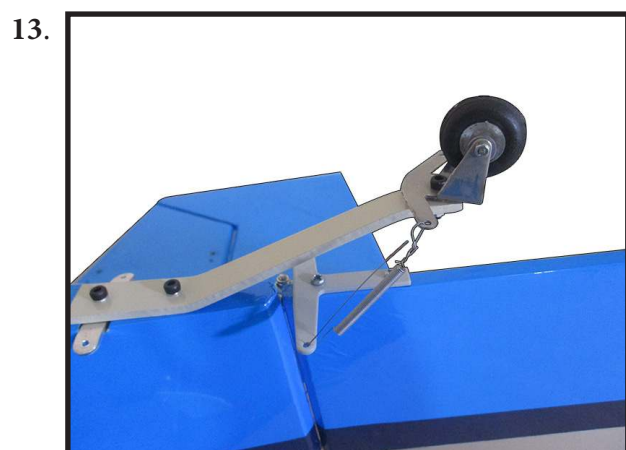
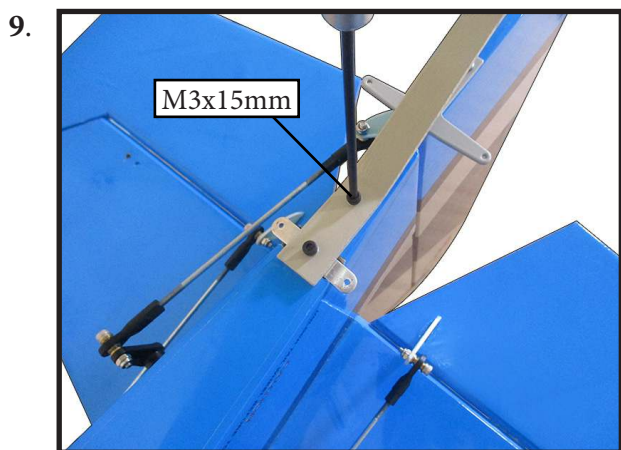
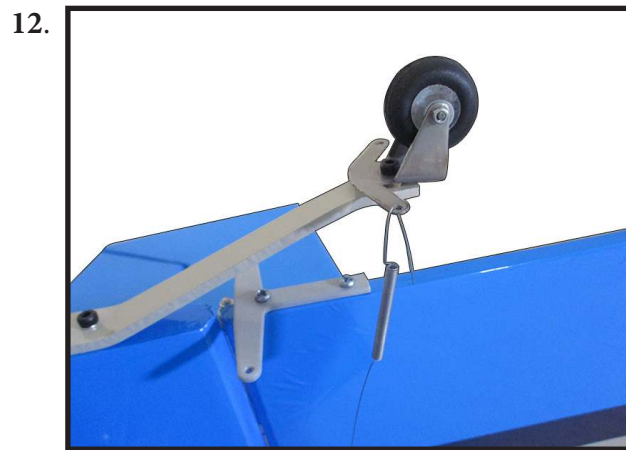
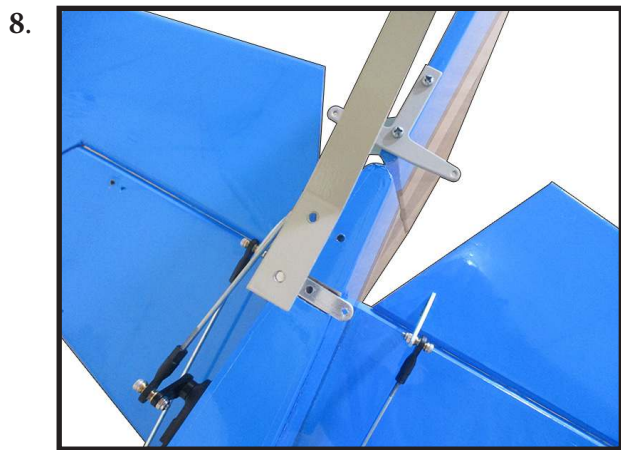

INSTALLING TAIL STRUT SUPPORT

The tail strut system assembly follow pictures below.

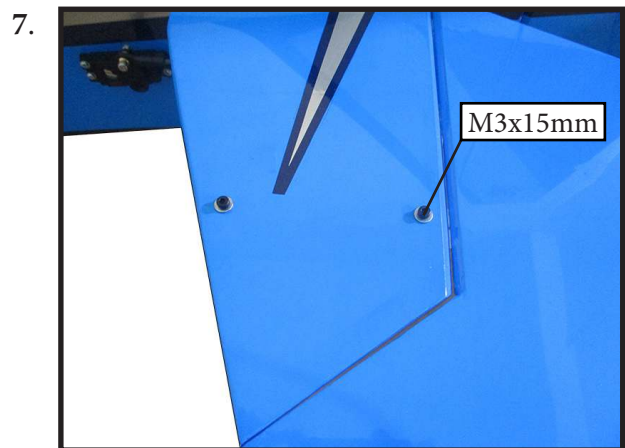
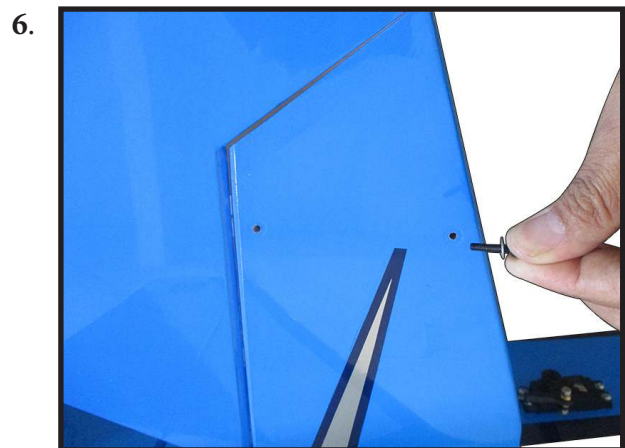
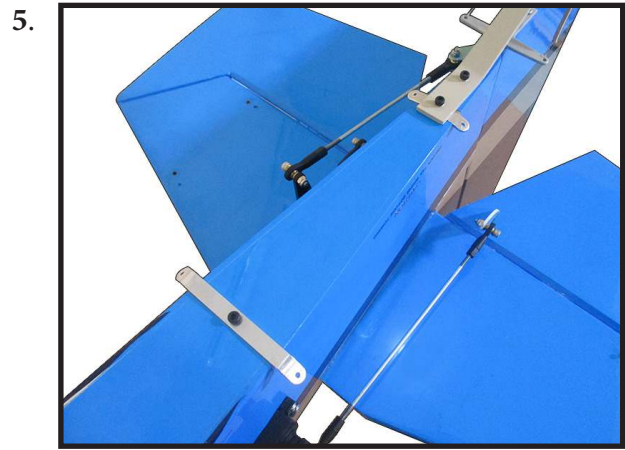
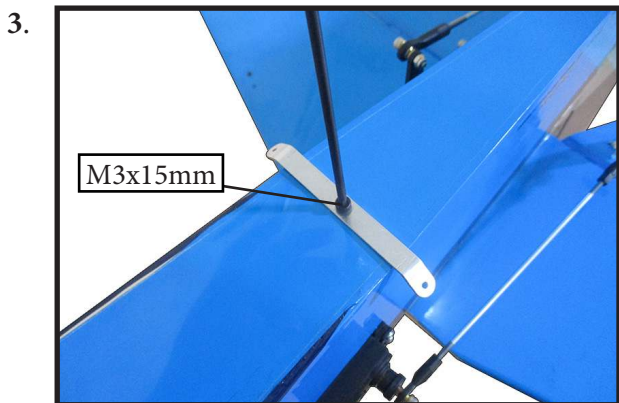
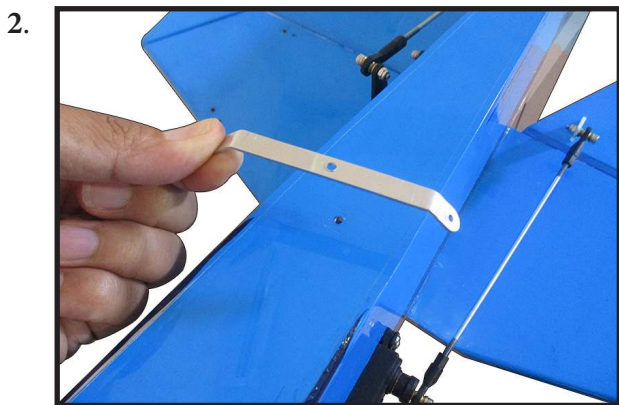
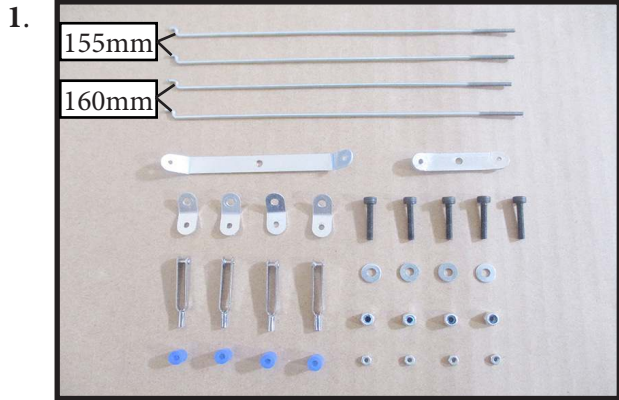

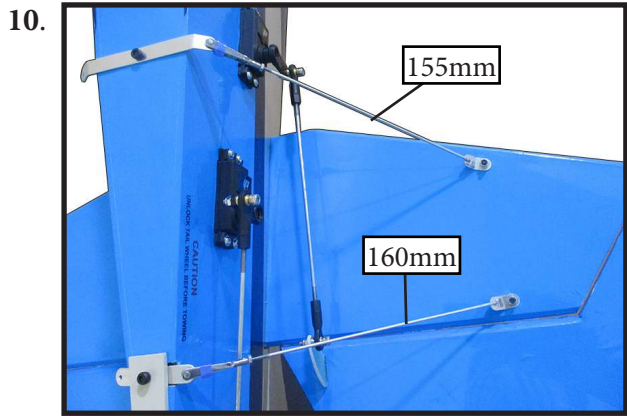
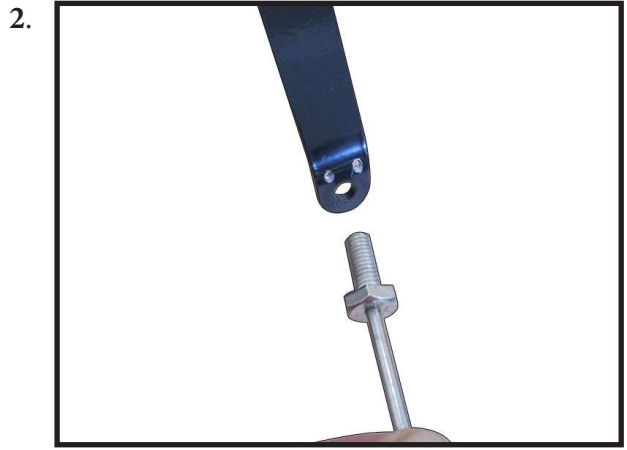

INSTALLING THE MAIN LANDING GEAR TO FUSELAGE

Please study images below.

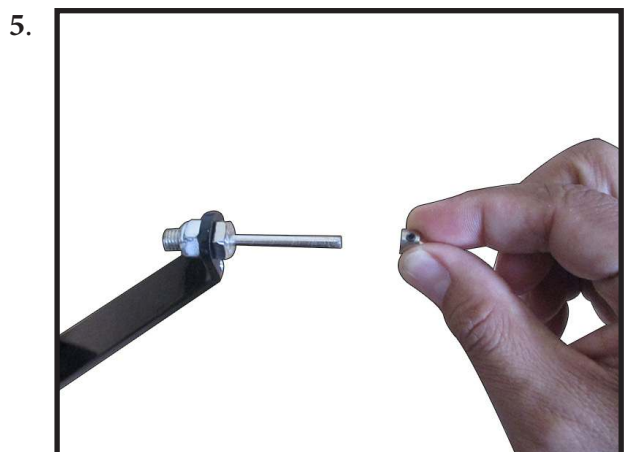

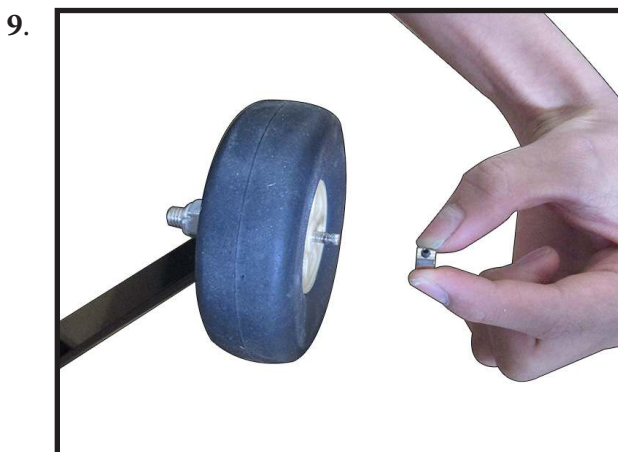
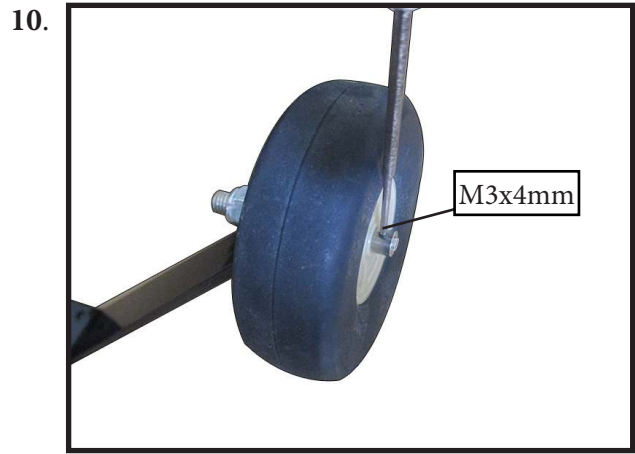
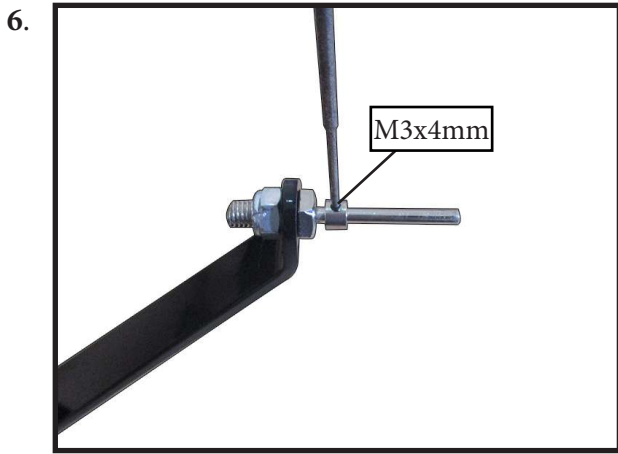

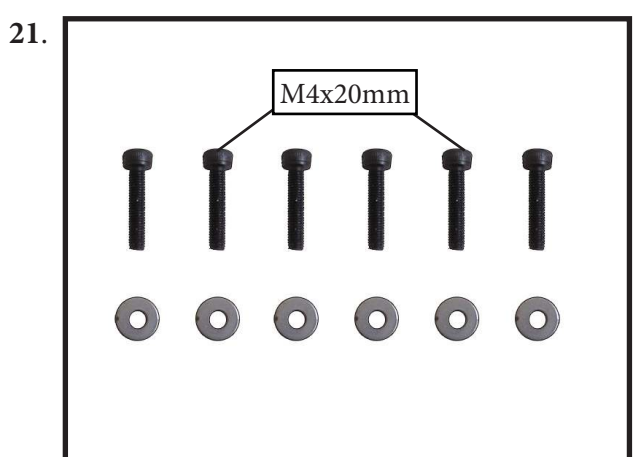
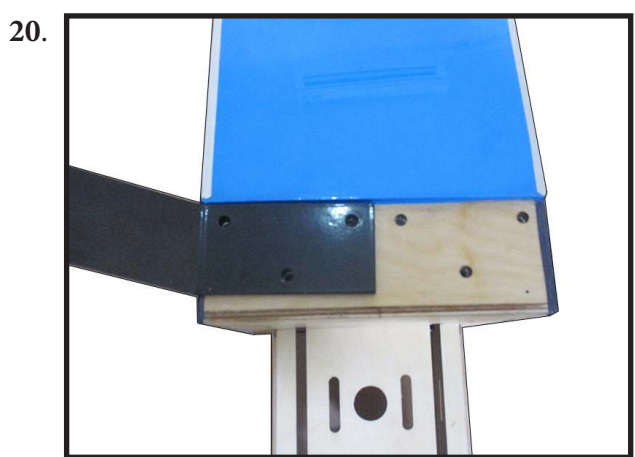
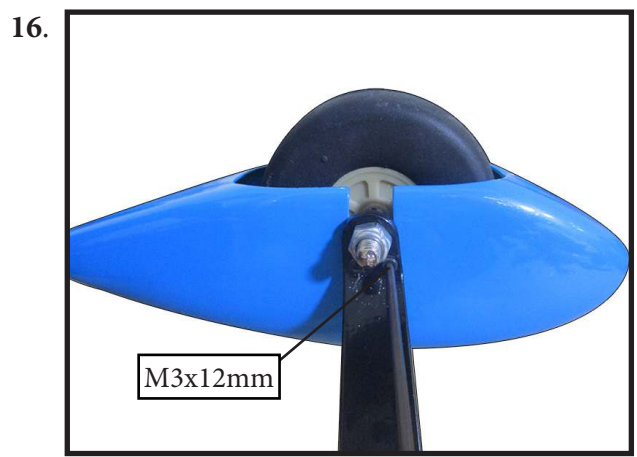
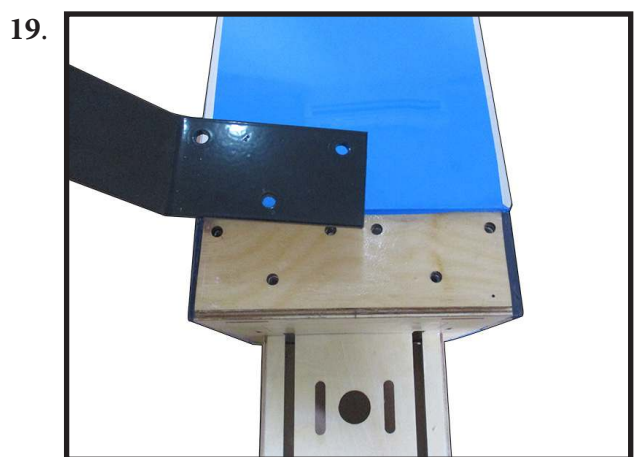
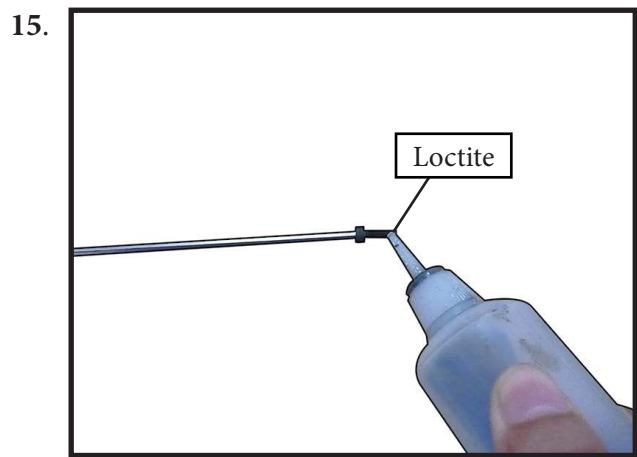
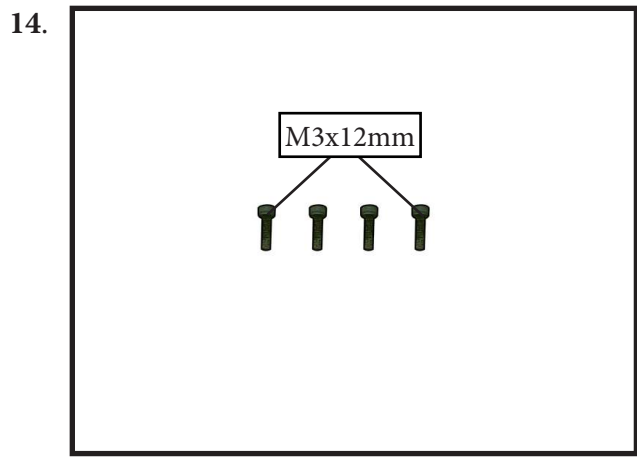

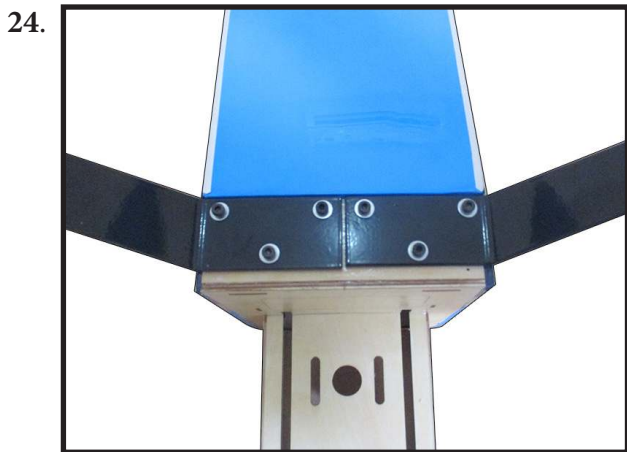
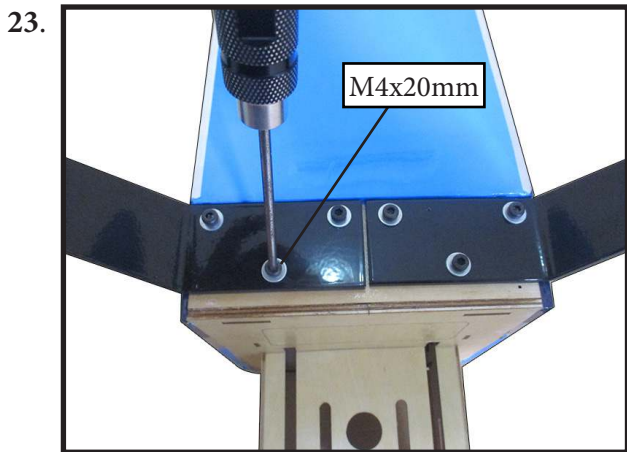
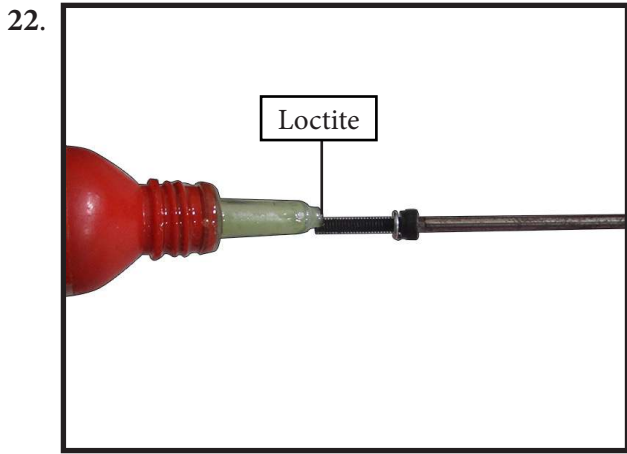

INSTALLING THE RECEIVER SWITCH

Install the switch into the precut hole in the side, in the fuselage.

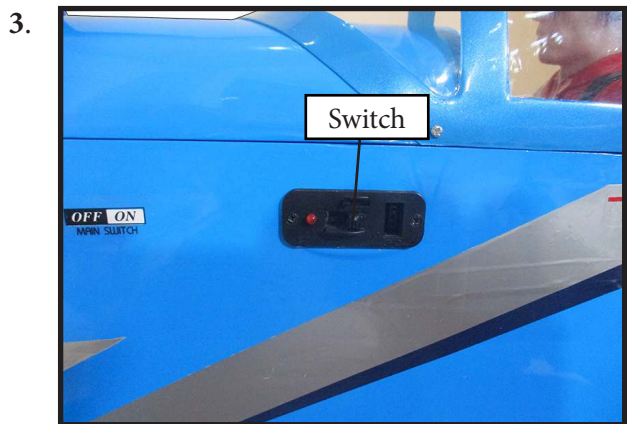
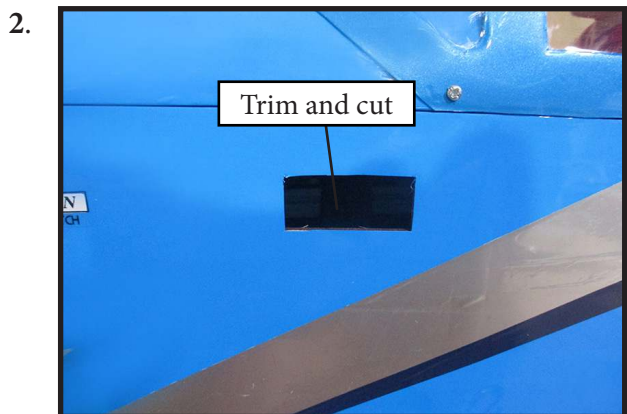
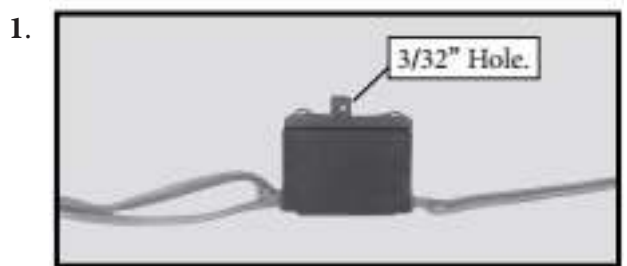

INSTALLING THE ENGINE SWITCH



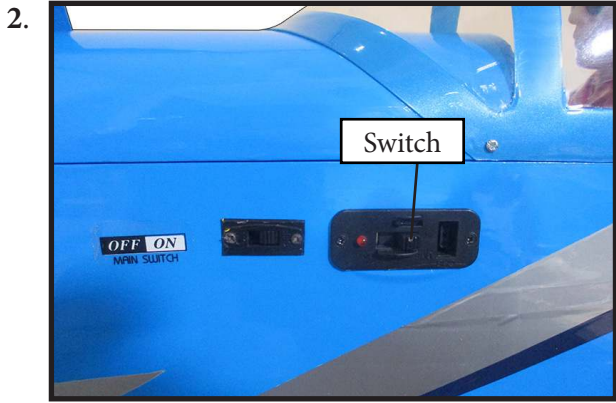

INSTALLING THE STOPPER ASSEMBLY

Using a modeling knife, carefully cut off the rear portion of one of the 3 nylon tubes leaving 1/2" protruding from the rear of the stopper. This will be the fuel pick up tube.

Using a modeling knife, cut one length of silicon fuel line. Connect one end of the line to the weighted fuel pick up and the other end to the nylon pick up tube.

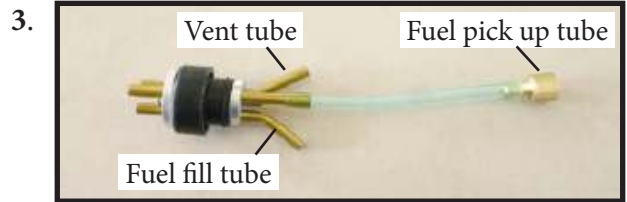
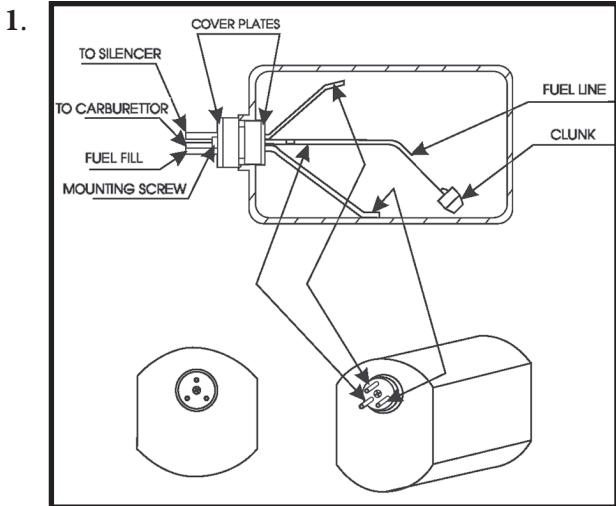

Carefully bend the second nylon tube up at a 45° angle. This tube is the vent tube.

Test fit the stopper assembly into the tank. It may be necessary to remove some of the flashing around the tank opening using a modeling knife. If flashing is present, make sure none falls into the tank.

With the stopper assembly in place, the weighted pick-up should rest away from the rear of the tank and move freely inside the tank. The top of the vent tube should rest just below the top of the tank. It should not touch the top of the tank.

When satisfied with the alignment of the stopper assembly tighten the 3 x 20mm machine screw until the rubber stopper expands and seals the tank opening. Do not over-tighten the assembly as this could cause the tank to split.

FUEL TANK INSTALLATION

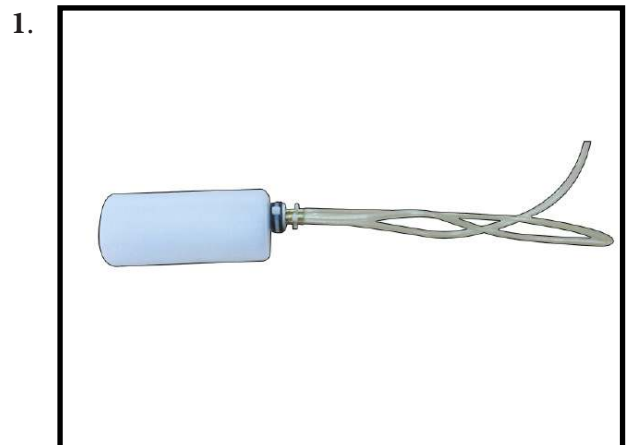

! *You should mark which tube is the vent and which is the fuel pickup when you attach fuel tubing to the tubes in the stopper. Once the tank is installed inside the fuselage, it may be difficult to determine which is which.*

Slide the fuel tank into the fuselage. Guide the lines from the tank through the hole in the firewall.

Use plywood template to hold in place the fuel tank with C/A glue to secure the fuel-tank inside the fuselage.

2.



3.

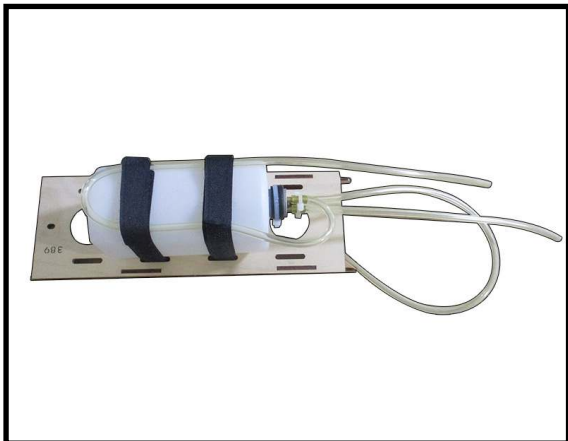

4.

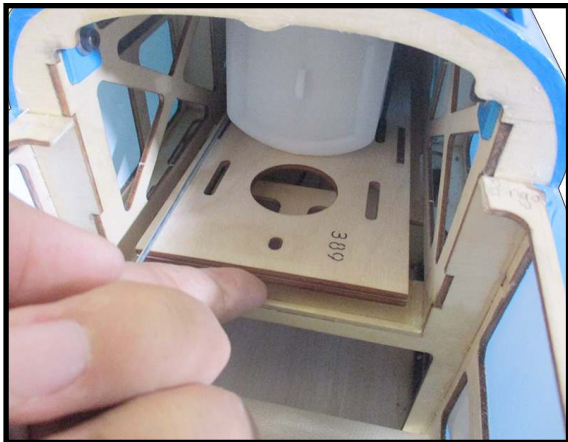

5.



6.



7.

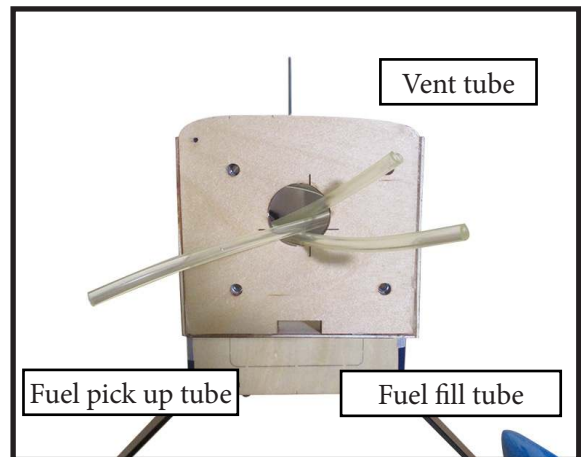

Connect the lines from the tank to the engine and muffler. The vent line will connect to the muffler and the line from the clunk to the carburetor.

! *Blow through one of the lines to ensure the fuel lines have not become kinked inside the fuel tank compartment. Air should flow through easily.*

ENGINE MOUNT INSTALLATION

Locate the items necessary to install the engine mount included with your model.

1.

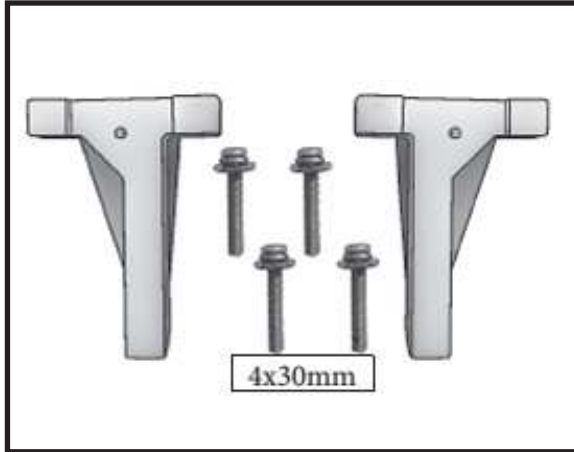

Use four 4x30mm head bolts and four 4mm washers to attach the engine mount rails to the firewall. Tighten the screws. Make sure to use threadlock on the screws to help prevent them from vibrating loose.

2.

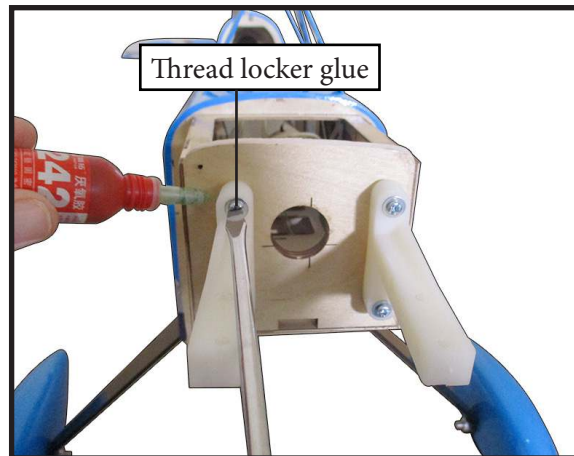

3.

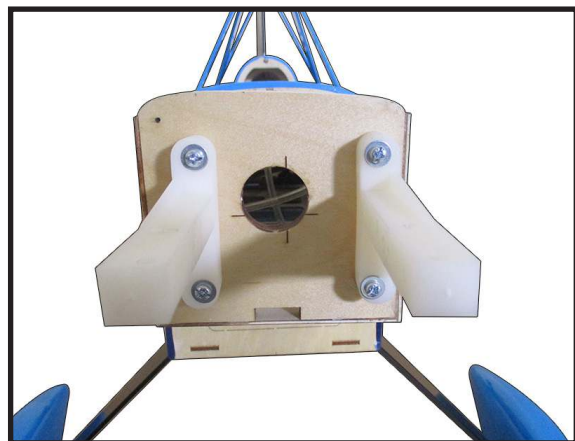

MOUNTING THE ENGINE

Position the engine with the drive washer (145mm) forward of the firewall as shown.

1.

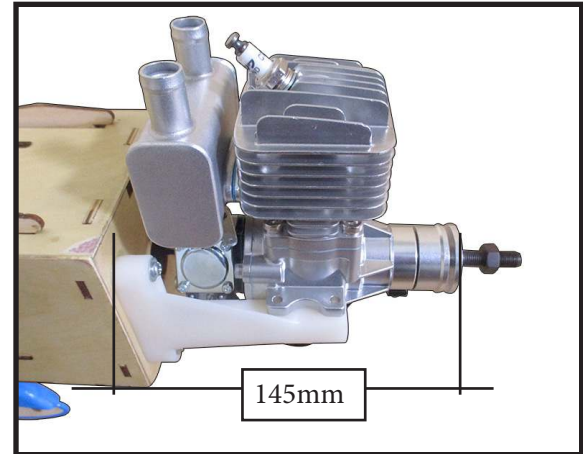

Use a pin drill and 4mm drill bit to drill a small indentation in the mount for the engine mounting screw.

2.

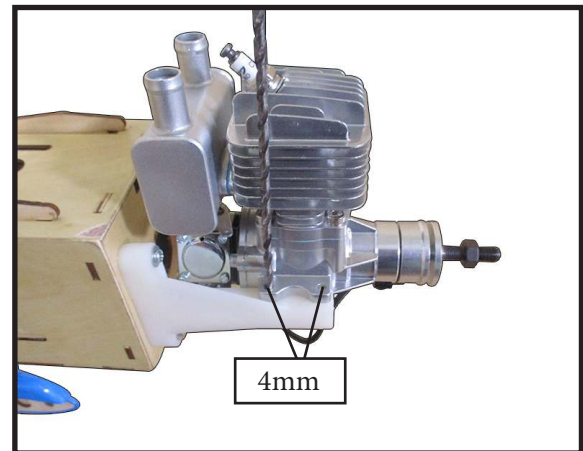

Use a drill to drill the four holes in the engine mount rails.

3.

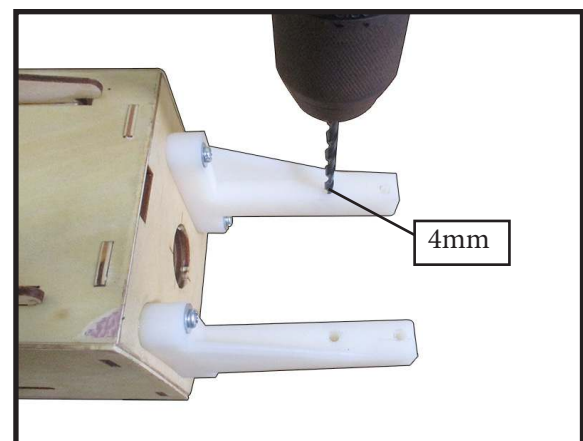

The fire wall has the location for the throttle pushrod tube (pre-drill).

Slide the pushrod tube in the firewall and guide it through the fuel tank mount. Use medium C/A to glue the tube to the firewall and the fuel tank mount.

Connect the Z-bend in the 450mm throttle pushrod to the outer hole of the carburetor arm.

Slide the throttle pushrod wire into the tube. Position the engine between the mounts. Use four M4x30mm machine screws to secure the engine to the mount as shown.

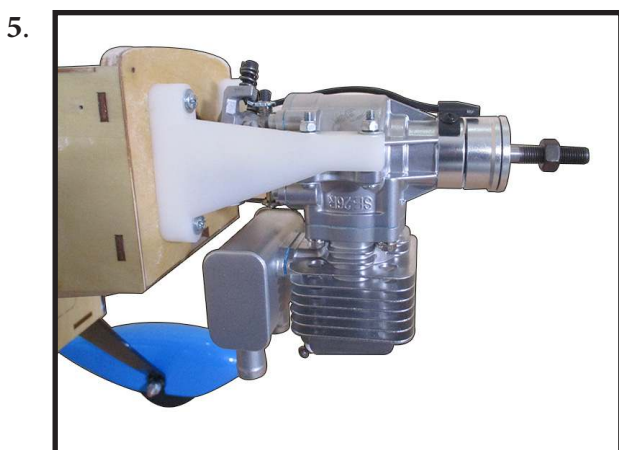
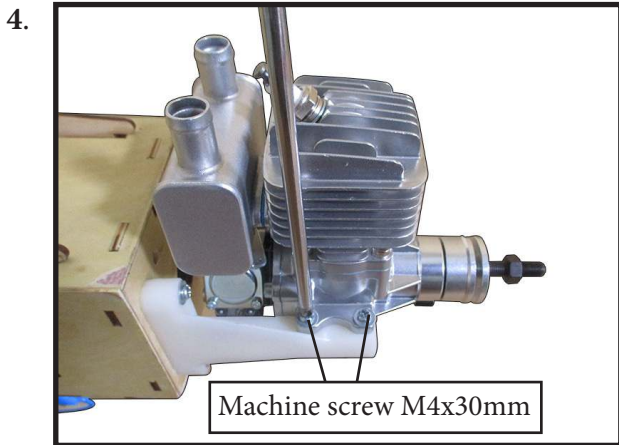

THROTTLE SERVO INSTALLATION

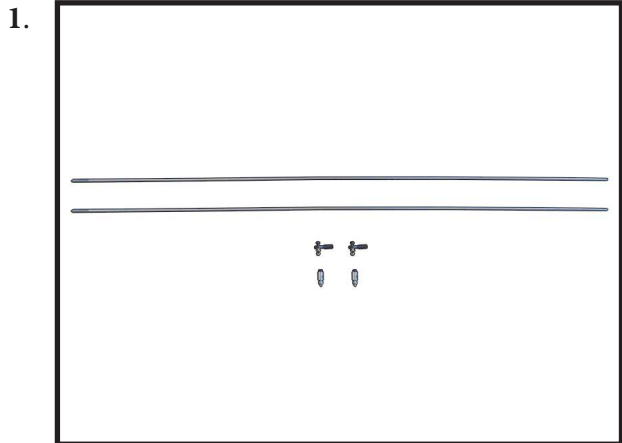

Use a 1/4" bit to drill a pushrod exit hole in the firewall in line with the engine carburetor throttle arm.

Assemble ball link to threaded end of pushrod.



Attach throttle pushrod to the carburetor throttle arm with the ball link.

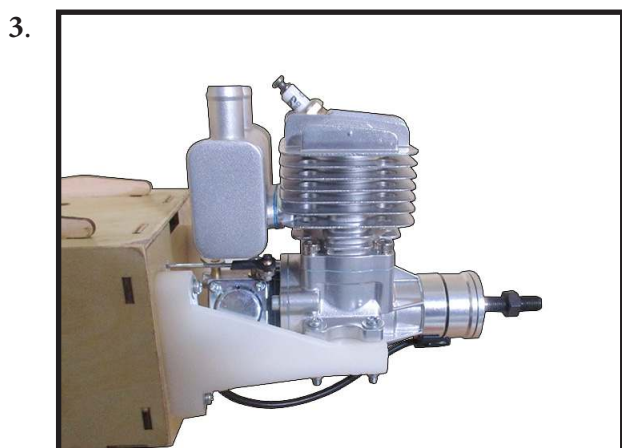

Install adjustable servo connector in the servo arm as same as picture below:



Reinstall the servo horn by sliding the connector over the pushrod wire. Center the throttle stick and trim and install the servo horn perpendicular to the servo center line.



Move the throttle stick to the closed position and move the carburetor to closed. Use a 2.5mm hex wrench to tighten the screw that secures the throttle pushrod wire. Make sure to use threadlock on the screw so it does not vibrate loose.

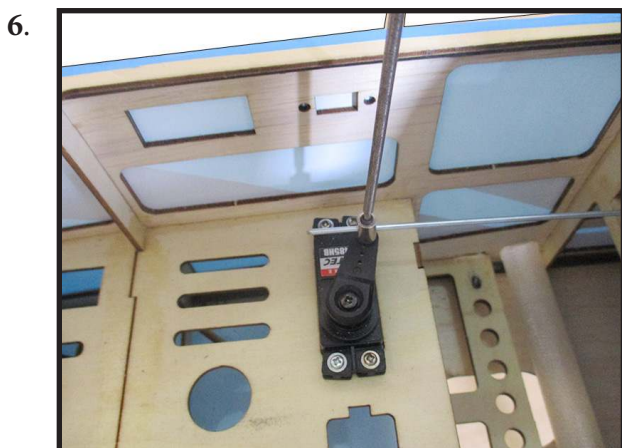

IGNITION INSTALLATION

I Thread nylon tie through mounting holes.

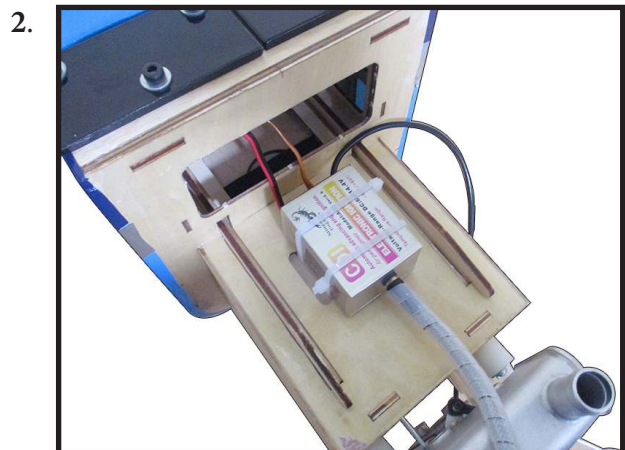
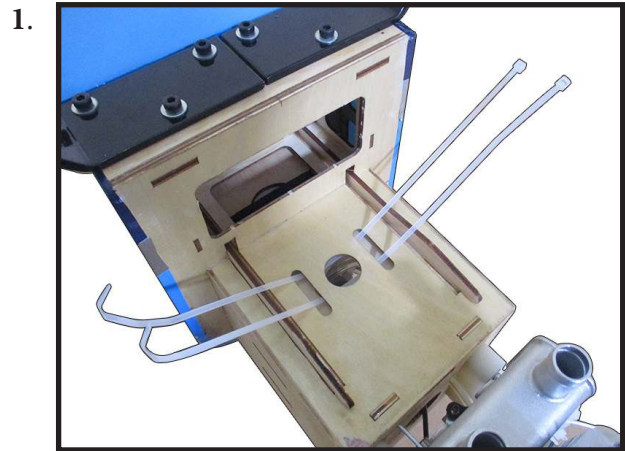

Connect ignition module to pickup line of engine. Secure with Safety Clip, safety wire, tape or other method. Ensure the plugs will not come apart from vibration or light tension.

Secure ignition wire with nylon ties as necessary.

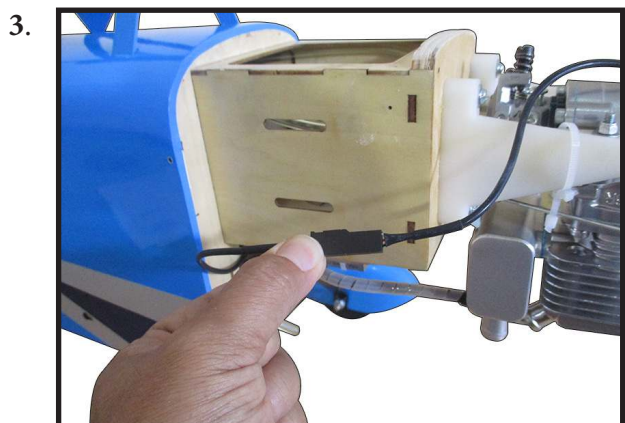

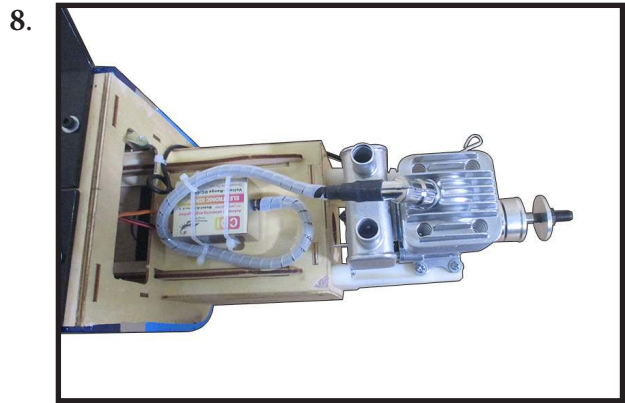
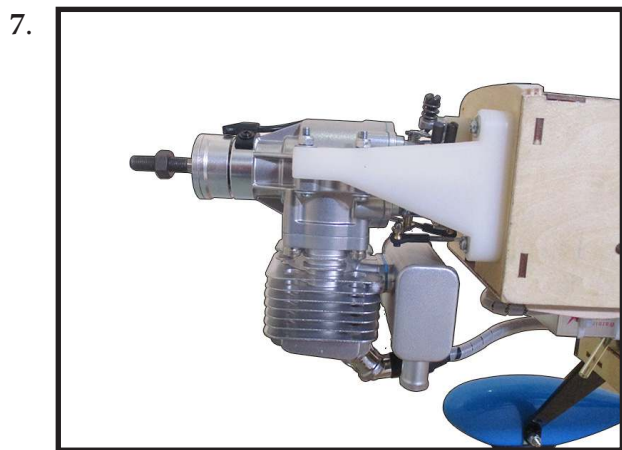
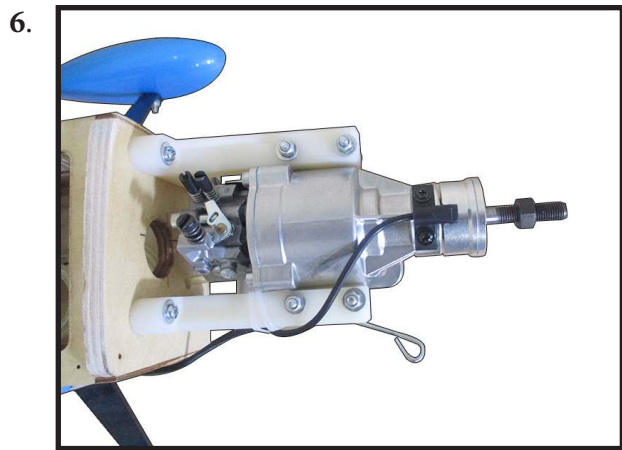
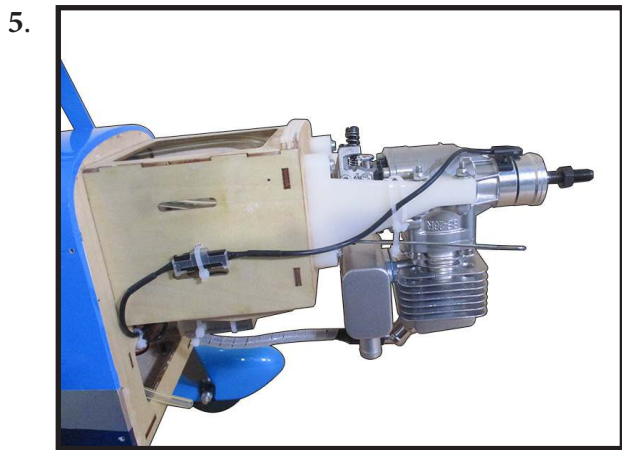
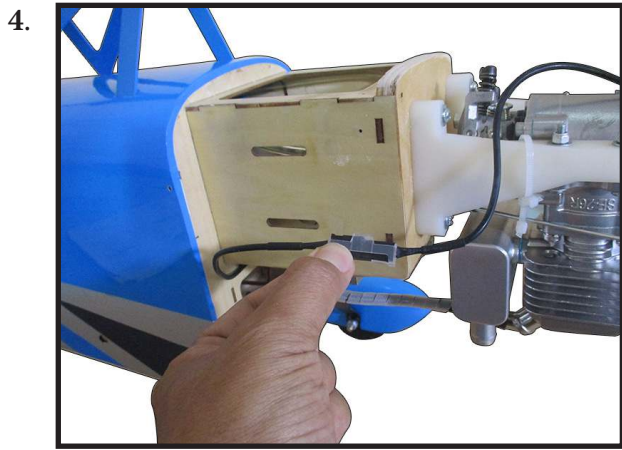

COWLING

Please see below pictures.

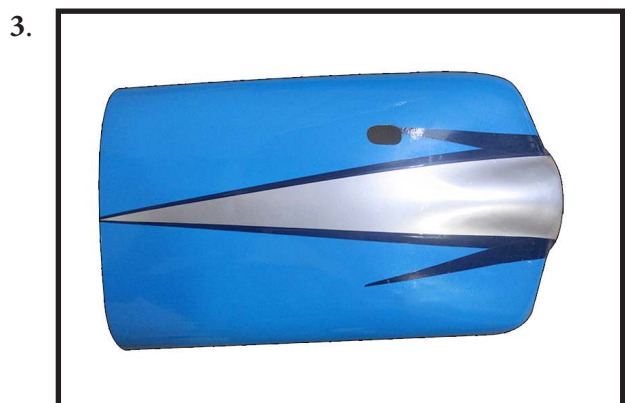
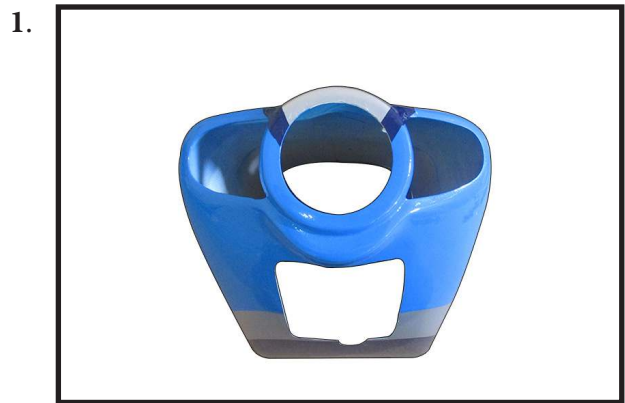

Tape the cowl to the fuselage using low-tack tape.



Use a drill and drill bit to drill the holes for the cowl mounting screws. Make sure the cowl position is correct before drilling each hole.

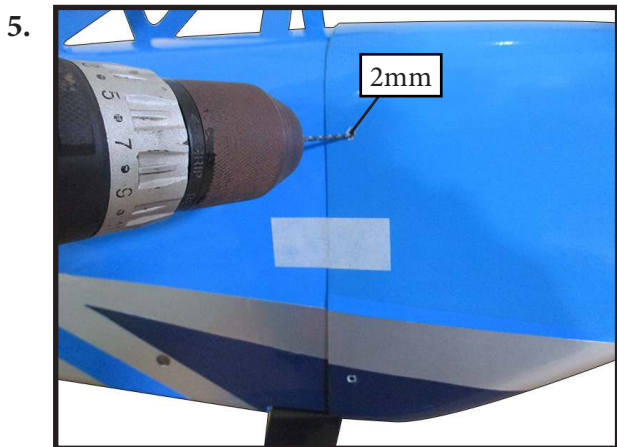

Install the muffler and muffler extension onto the engine and make the cutout in the cowl for muffler clearance. Connect the fuel and pressure lines to the carburetor, muffler and fuel filter valve. Secure the cowl to fuselage using the M3x10mm socket head screws. Putting a small length of silicon fuel tube under the head of the screw helps with vibration.

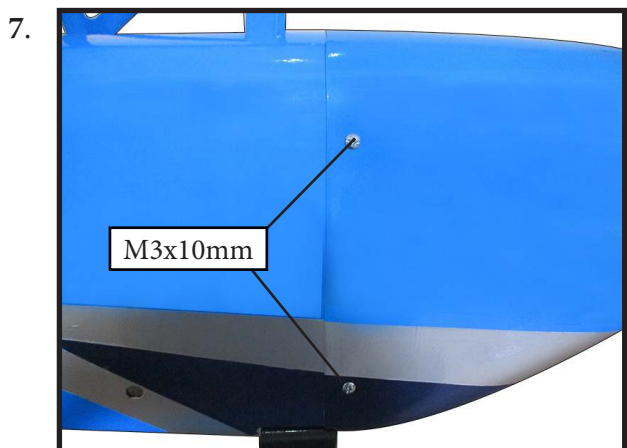
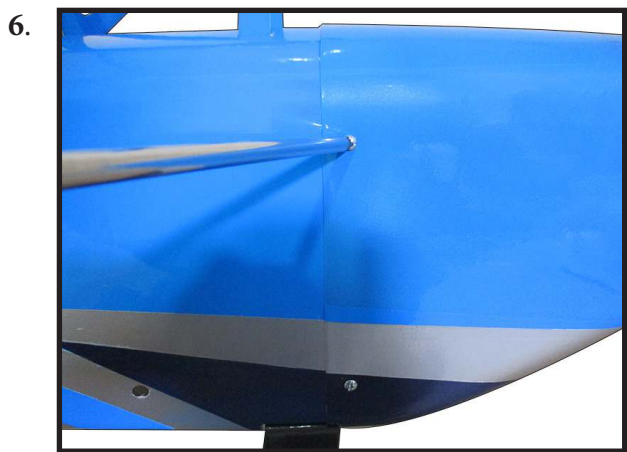

ELECTRIC POWER CONVERSION

Locate the items necessary to install the electric power conversion included with your model.

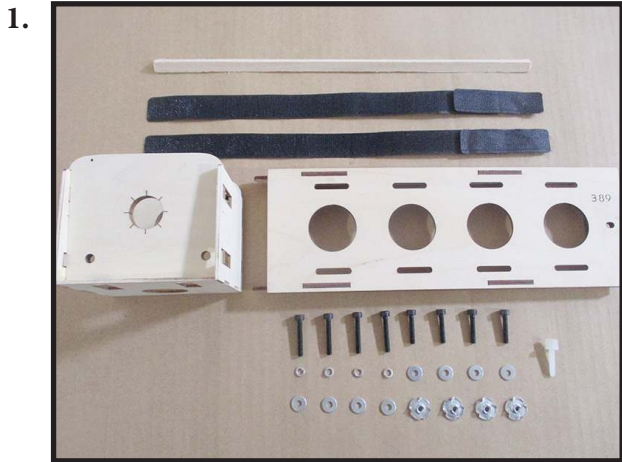

Recommend the items necessary to install the electric power conversion parts included with your model.

- **Motor: 110 - 2000 Watts**
- **Propeller: 17x8 ~ 19x10**
- **ESC: 85A**
- **6S- 8S Lipo**

Attach the electric motor box to the firewall centered with the cross lines drawn on the electric motor box and firewall. Using M4x25mm to secure the motor box to the firewall. Please see pictures below.

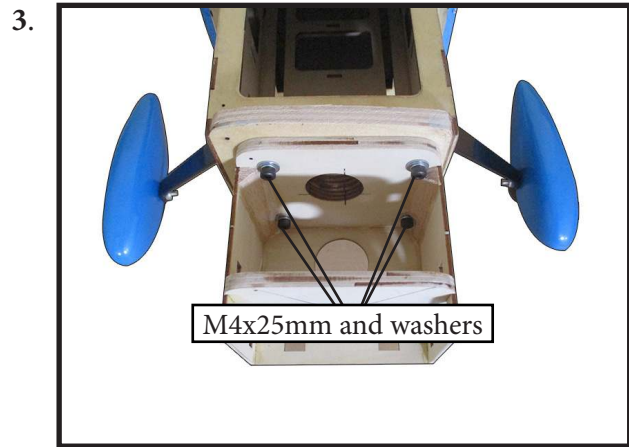
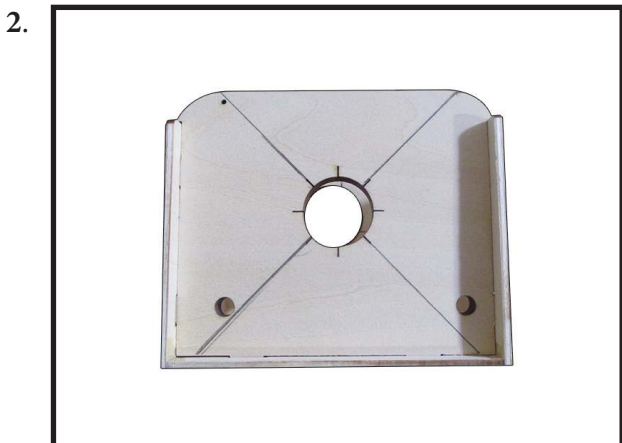

Attach the motor mount to the front of the electric motor box using four 5.5mm blind nut, four M4x25mm hex head bolts to secure the motor. Please see picture shown.

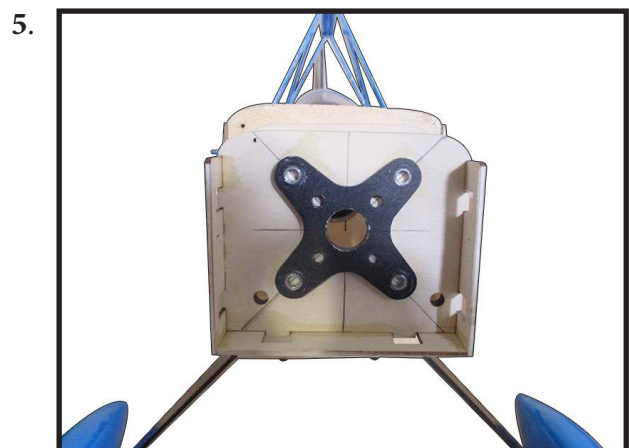

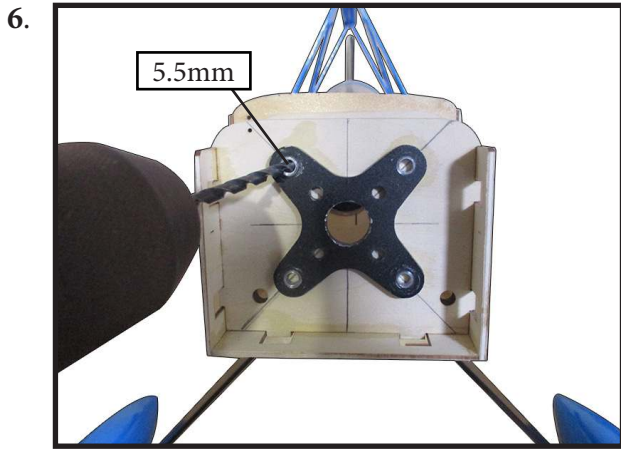

Then, use 5.5mm drill bit to enlarge the holes on the electric motor box.

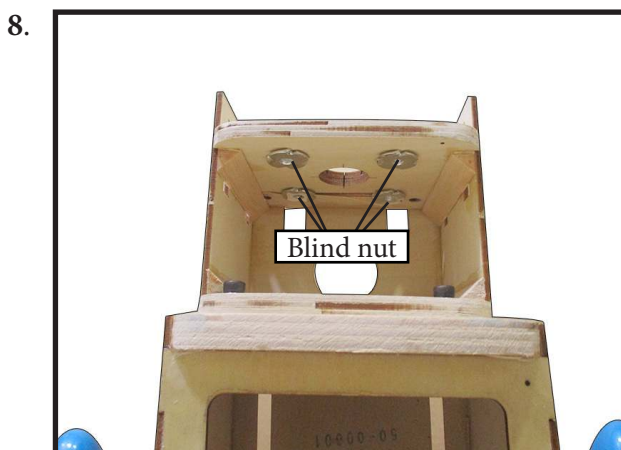
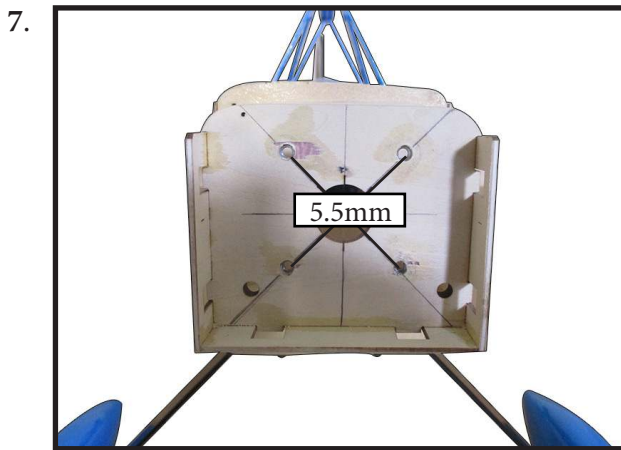

Attach the motor to the front of the electric motor box using four 4mm blind nut, four M4x20mm hex head bolts to secure the motor. Please see picture shown.

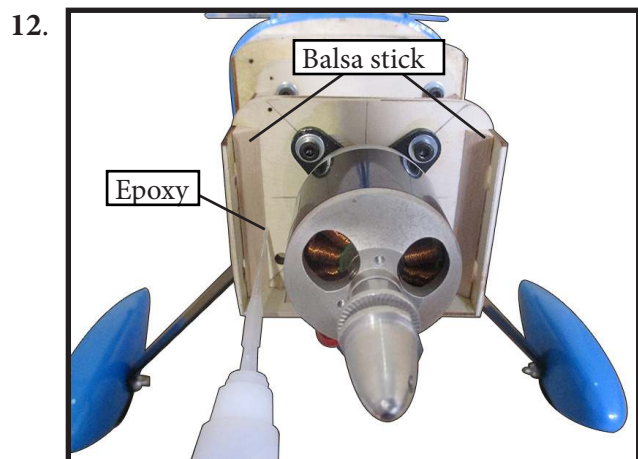
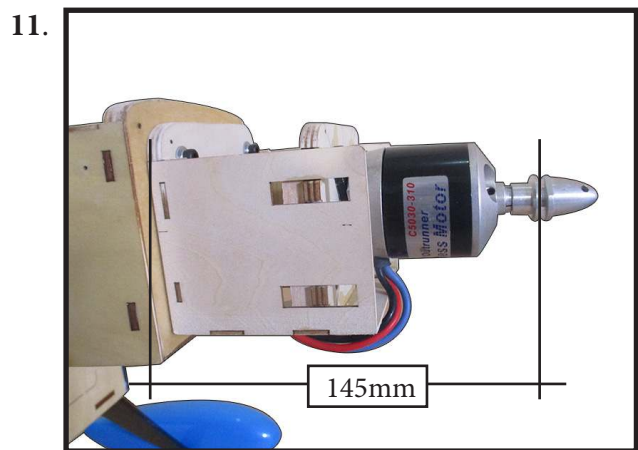
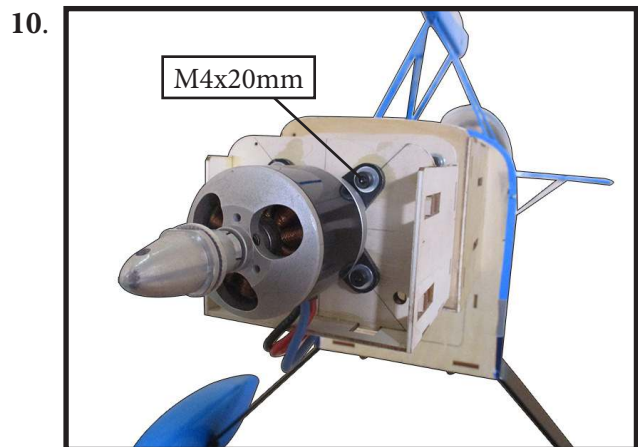
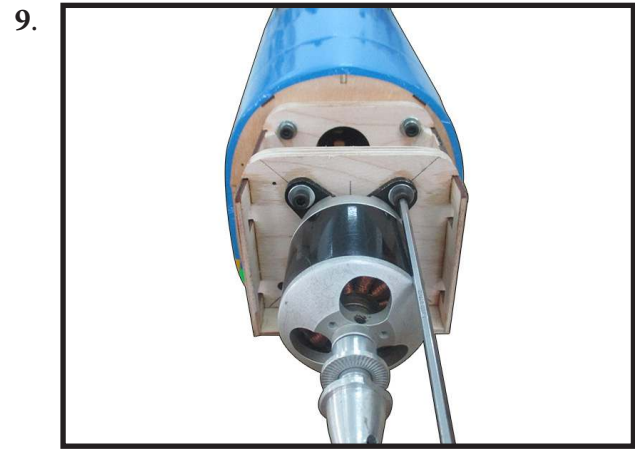

Attach the speed control to the side of the motor box using two-sided tape and tie wraps. Connect the appropriate leads from the speed control to the motor. Make sure the leads will not interfere with the operation of the motor.

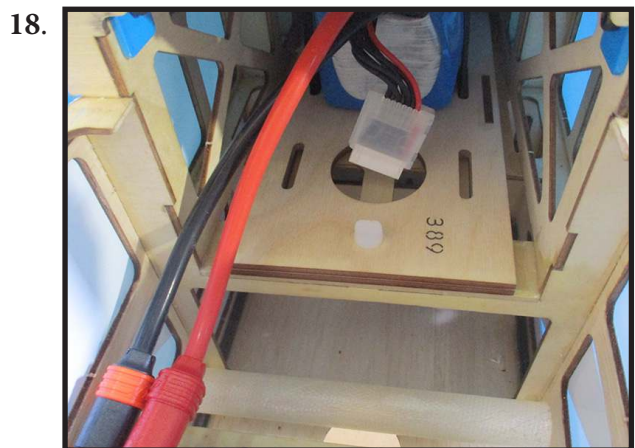
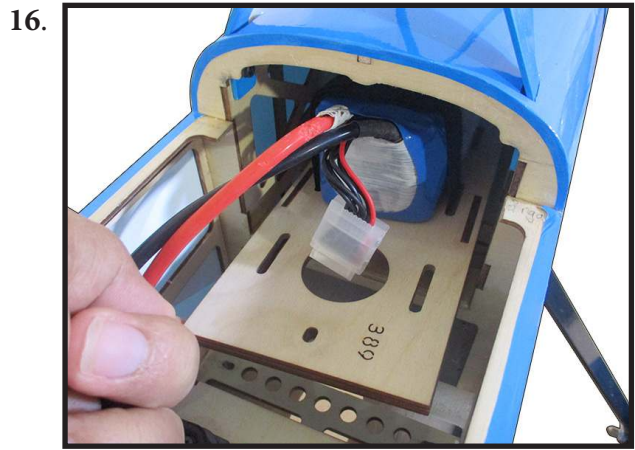
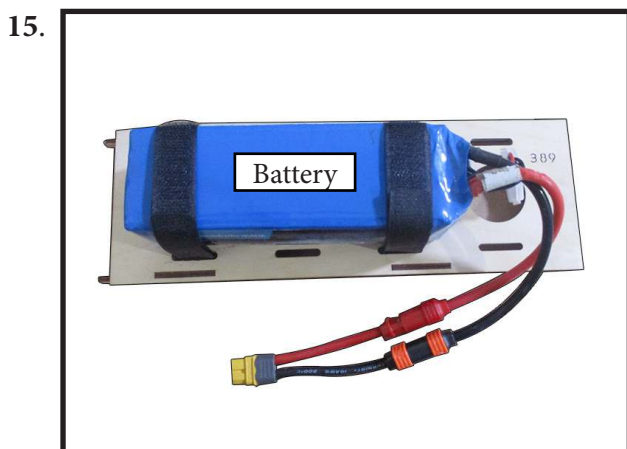
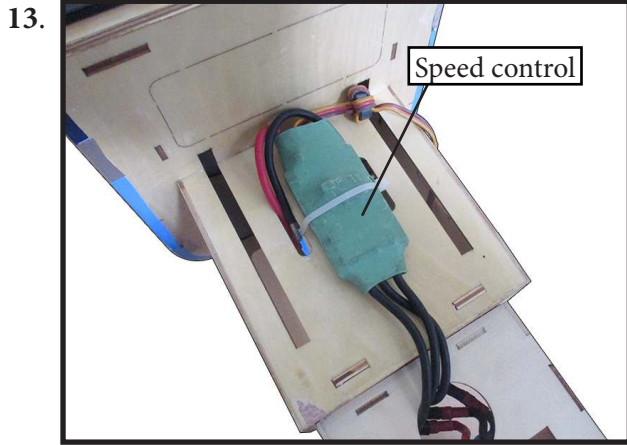

INSTALLING THE SPINNER

Install the spinner backplate, propeller and spinner cone.

1.

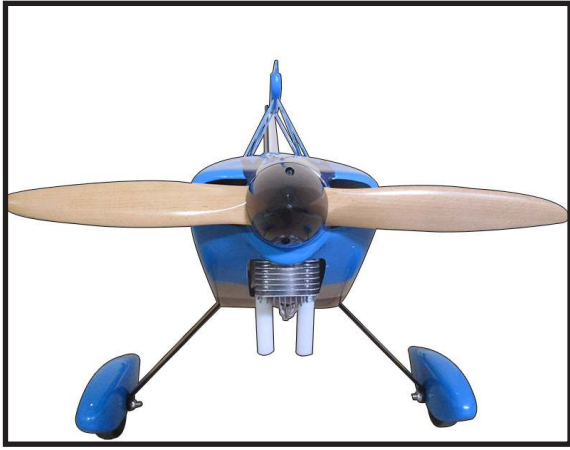

2.

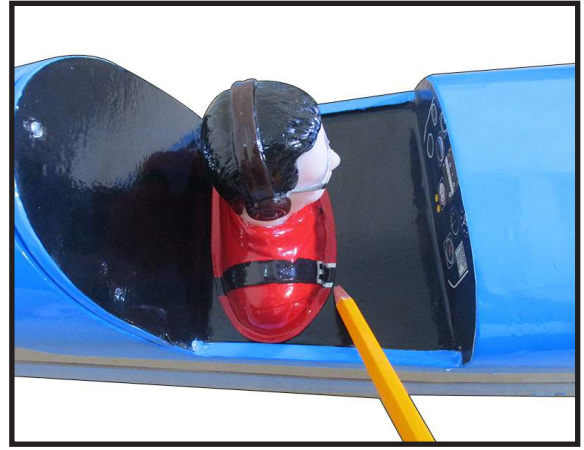

⚠ The propeller should not touch any part of the spinner cone. If it does, use a sharp modeling knife and carefully trim away the spinner cone where the propeller comes in contact with it.

3.



2.

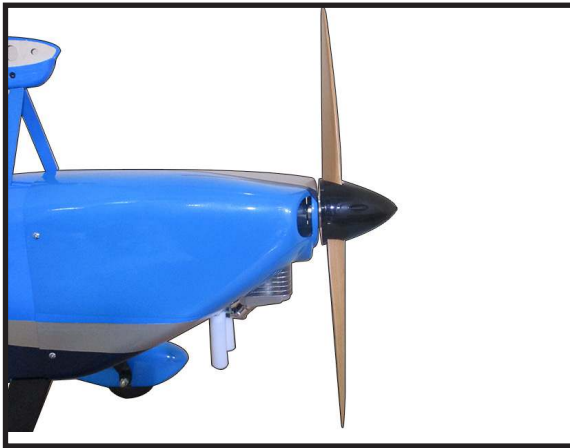

4.



INSTALLATION PILOT AND CANOPY

Locate items necessary to install pilot and canopy.

1.



5.

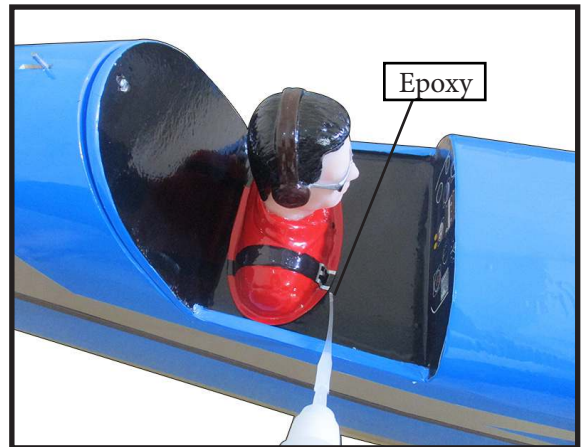



Epoxy canopy onto the fuselage. Trace around the canopy and onto the fuselage using a epoxy.

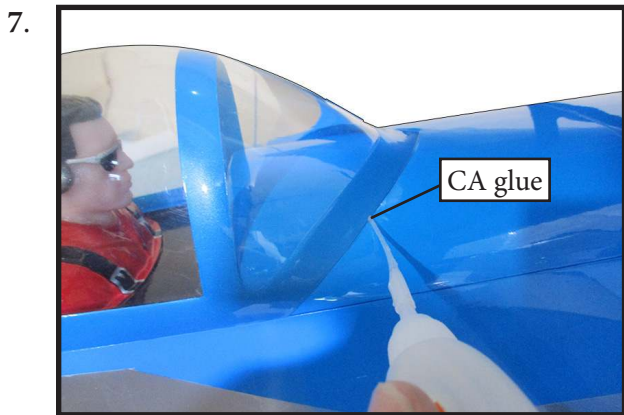

INSTALLING THE BATTERY-RECEIVER

Plug the servos leads and the switch lead into the receiver. Plug the battery pack lead into the switch also.

Wrap the receiver and battery pack in the protective foam rubber to protect them from vibration.

Route the antenna in the antenna tube inside the fuselage and secure it to the bottom of fuselage using a plastic tape.

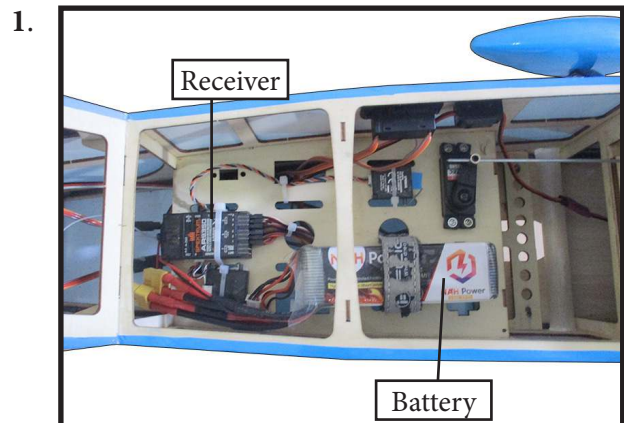

CABANE STRUT INSTALLATION

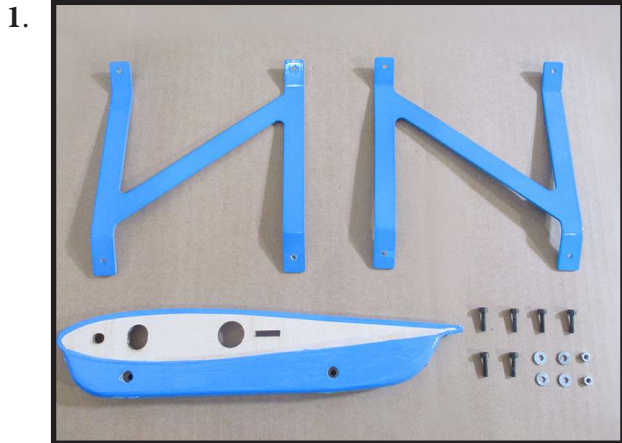

Remove the covering in the top of the fuselage for the cabane struts.

Slide the cabane into position.

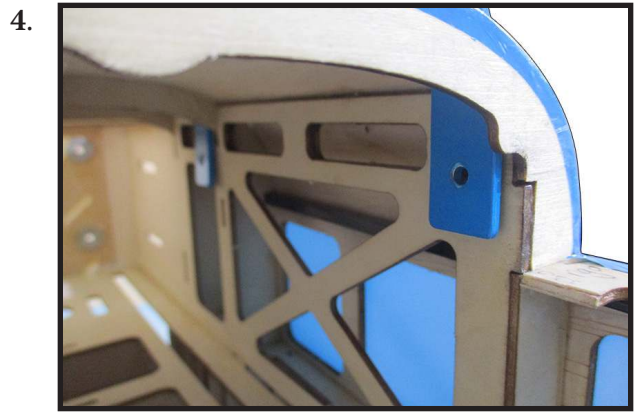
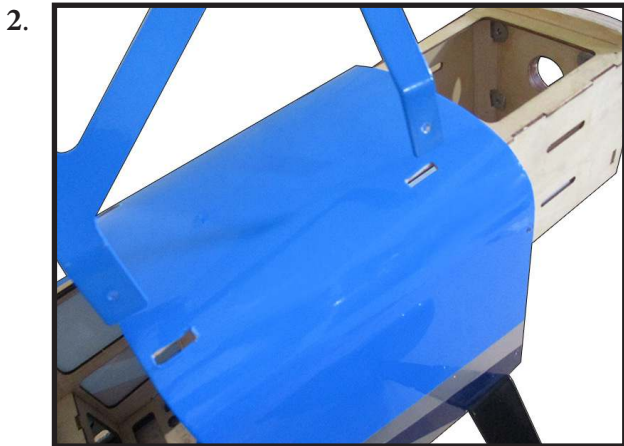

Secure the cabane into position using 4 socket head bolts.

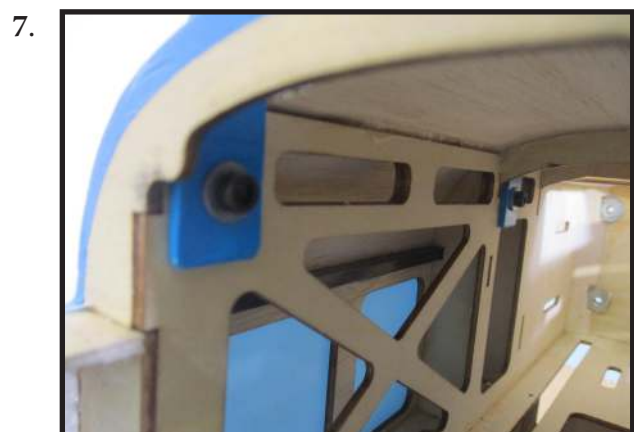
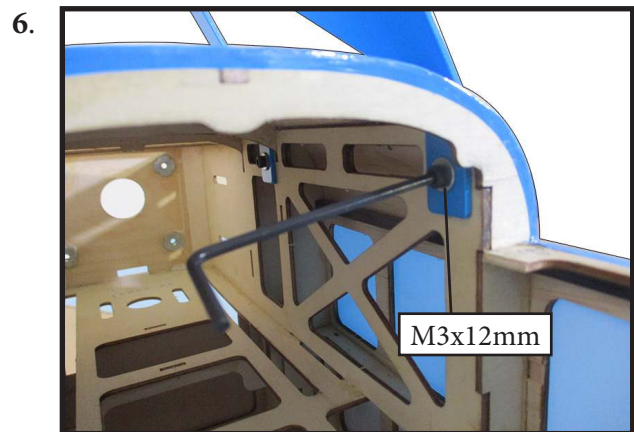
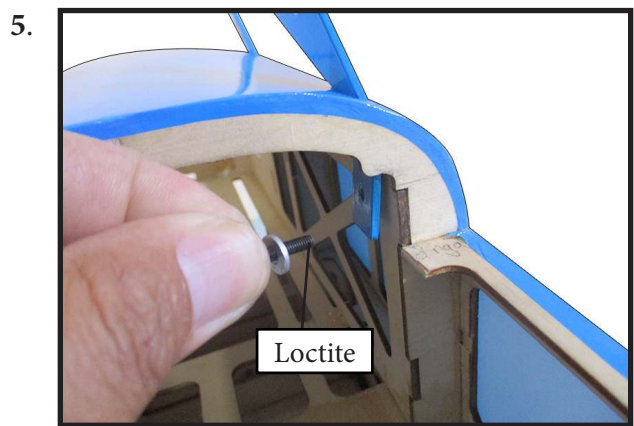

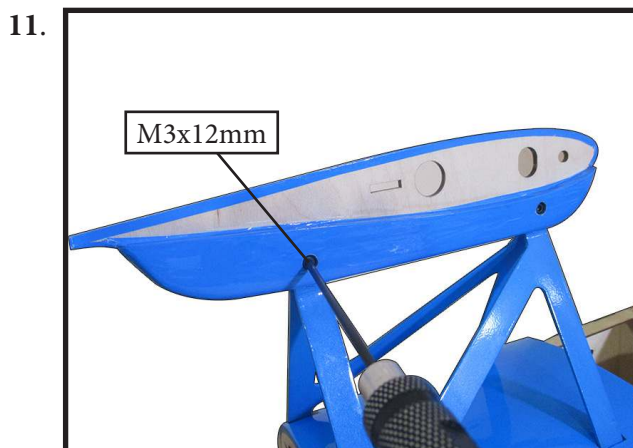

ATTACHMENT WING - FUSELAGE

Attach the aluminium tube into fuselage.

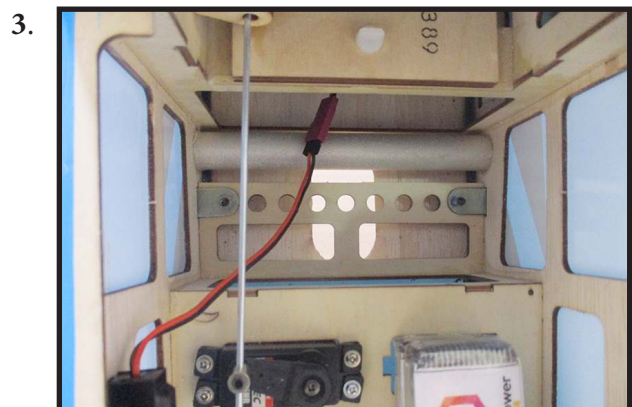
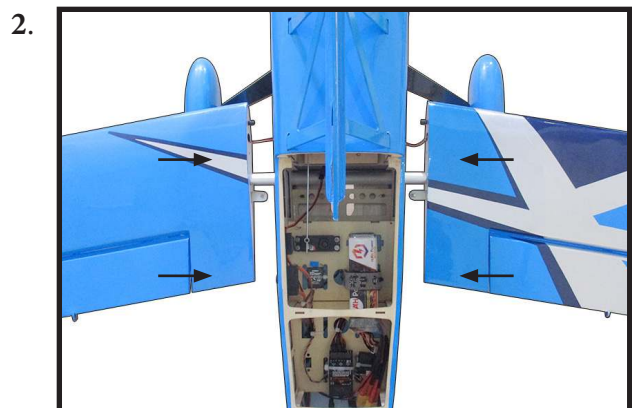
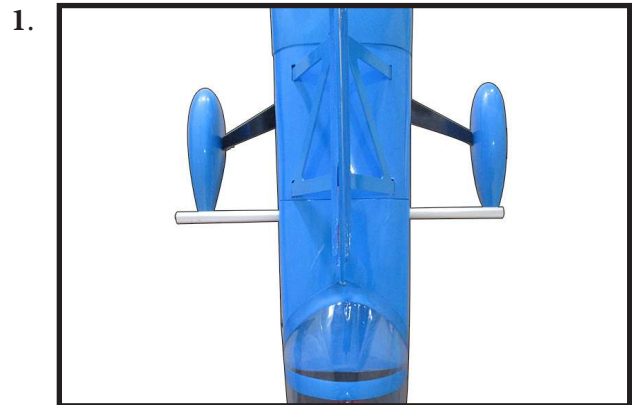

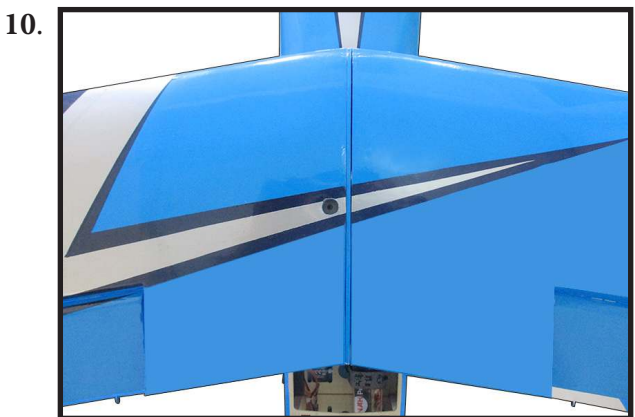
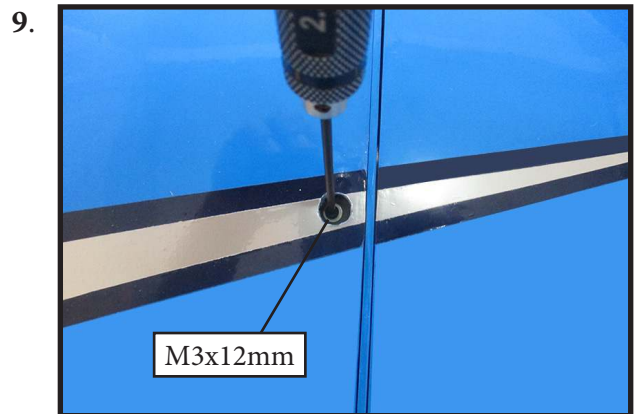
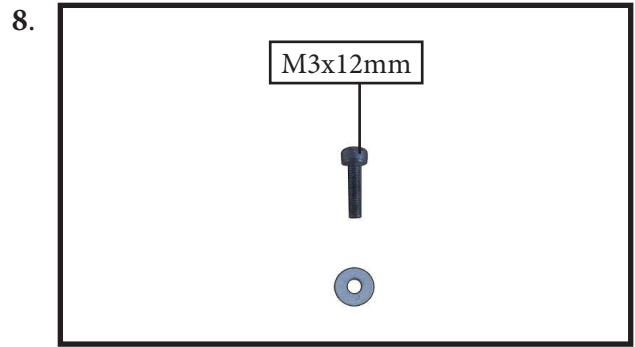
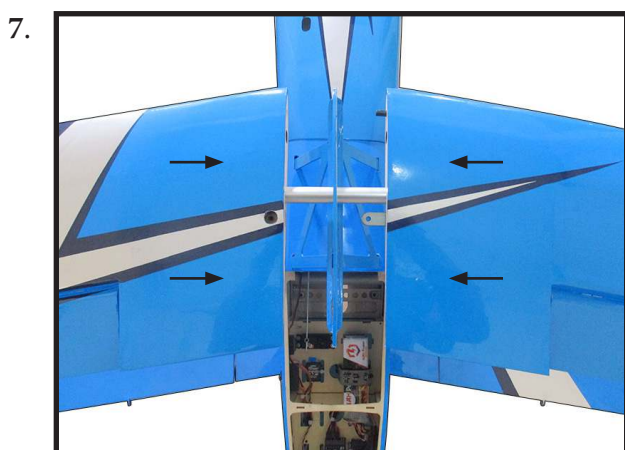
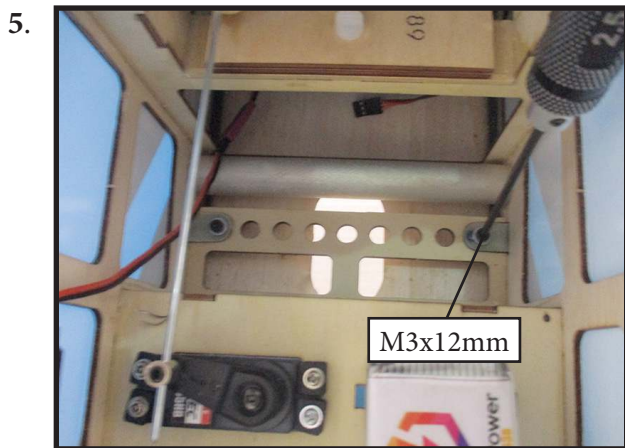
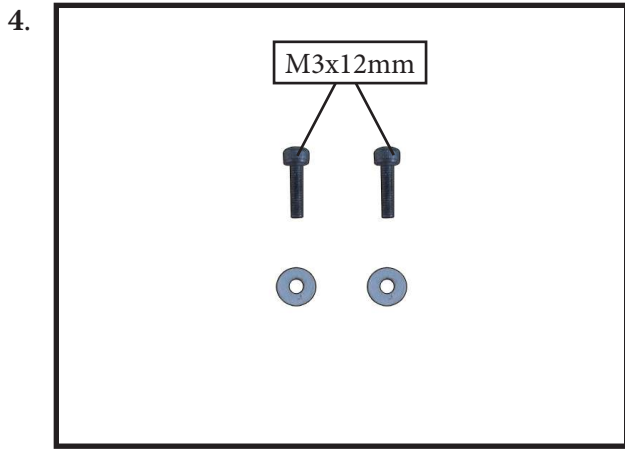

INTERPLANE STRUT INSTALLATION

Place on strut into position. Make sure the curves on the strut follow the airfoil of the wings.

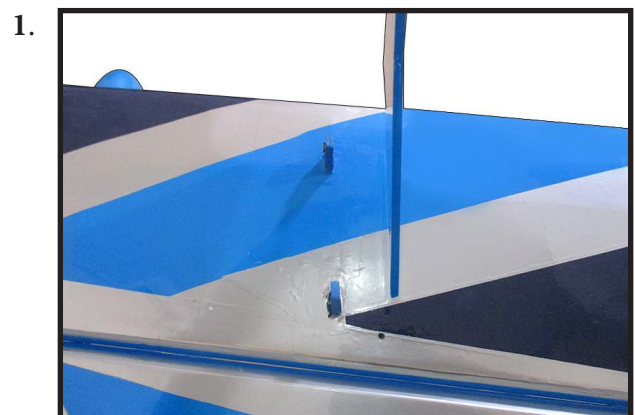

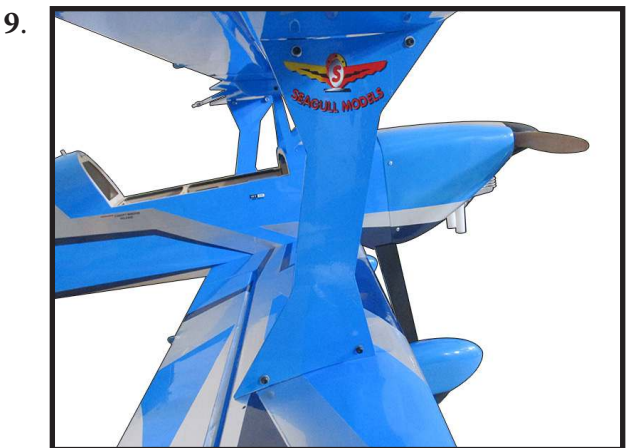
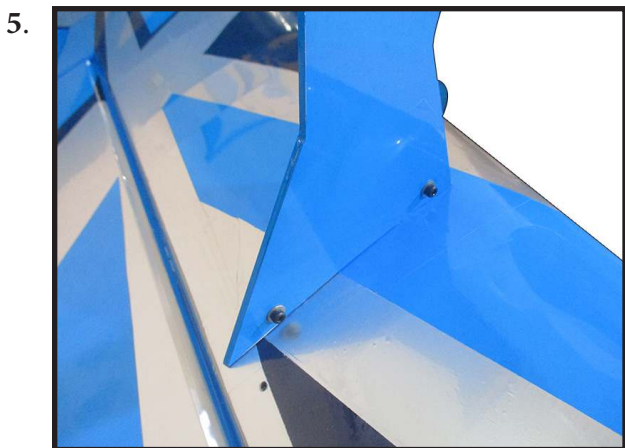
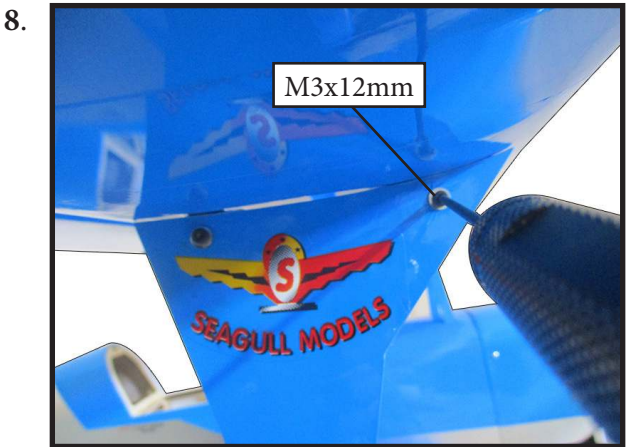
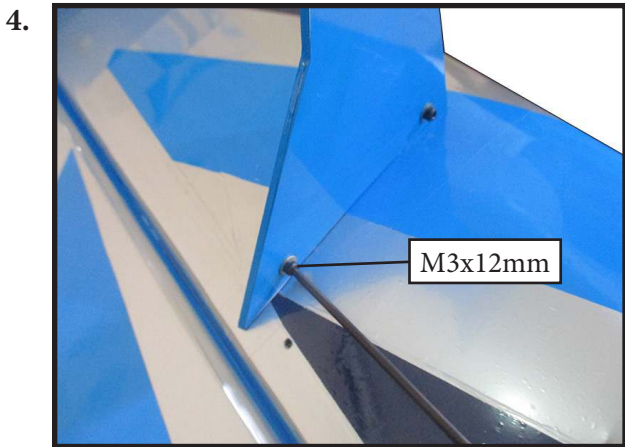
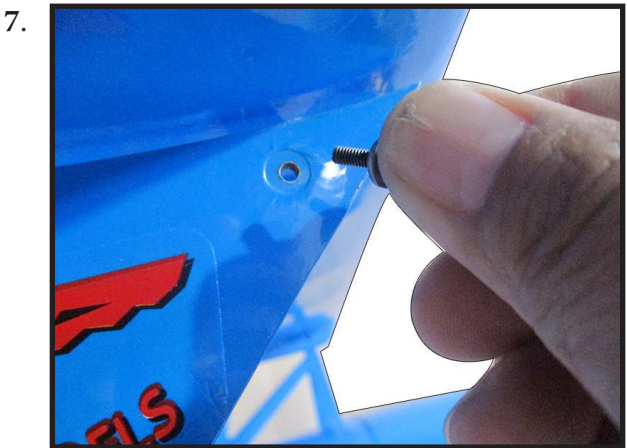
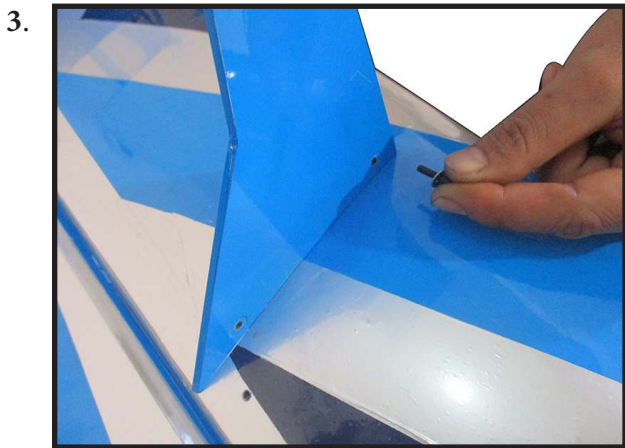
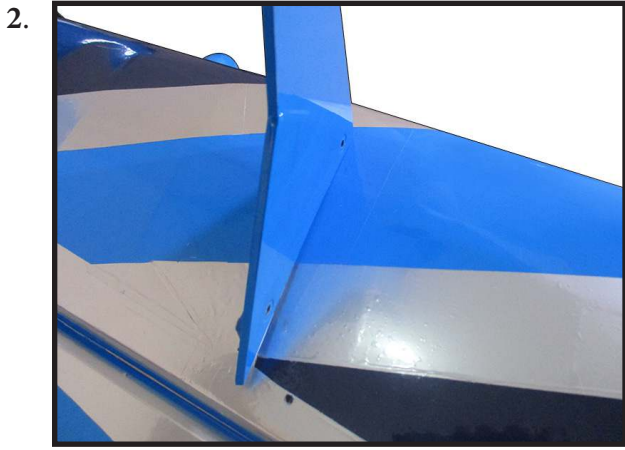

**INSTALLING THE AILERON LINKAGE
(UPPER-LOWER MAIN WING)**

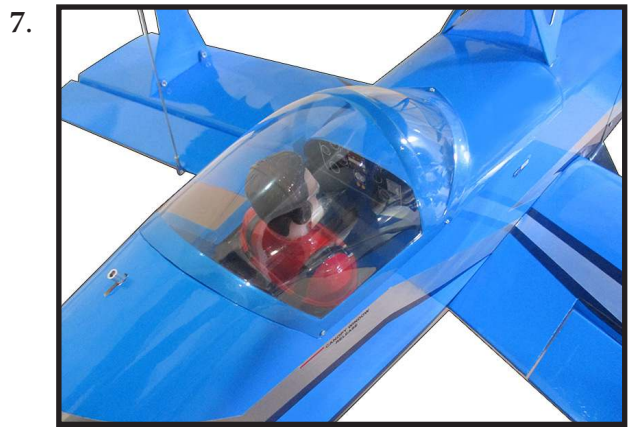
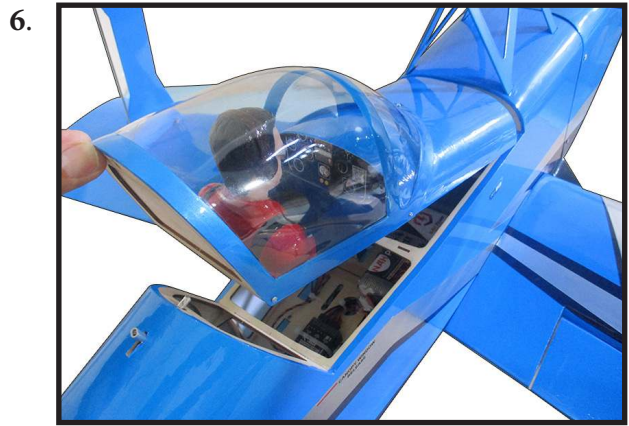
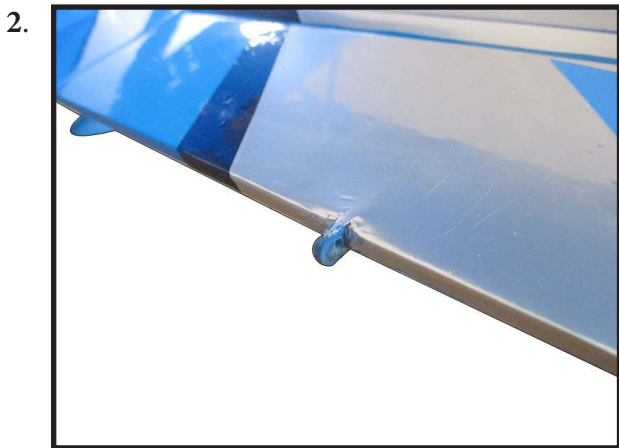
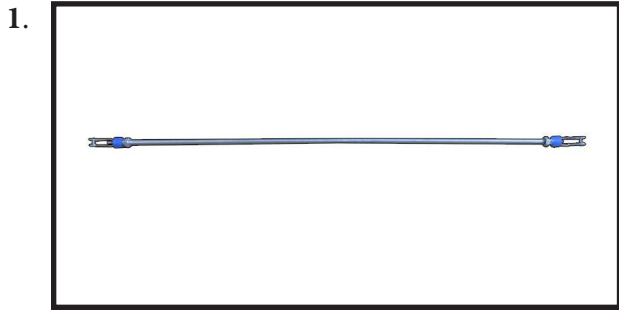

REMOVING THE WING PANELS

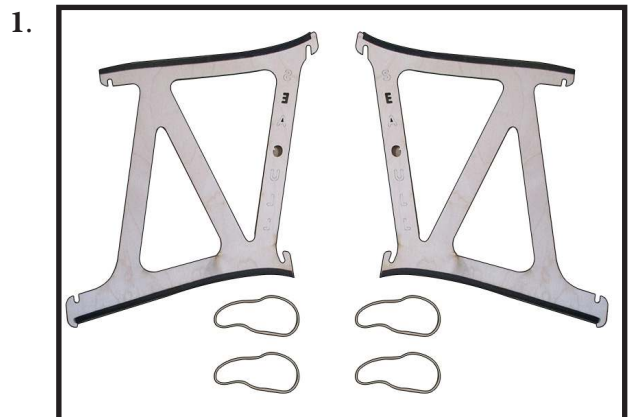

Locate the wing transport frames and rubber bands. Slide the frames between the top and bottom wing as shown. Use a rubber band to hold the frame to the top and bottom wing.



APPLY THE DECALS

1) If all the decals are precut and ready to stick. Please be certain the model is clean and free from oily fingerprints and dust. Position decal on the model where desired, using the photos on the box and aid in their location.

2) If all the decals are not precut, please use scissors or a sharp hobby knife to cut the decals from the sheet. Please be certain the model is clean and free from oily fingerprints and dust. Position decal on the model where desired, using the photos on the box and aid in their location.

BALANCING

1) It is critical that your airplane be balanced correctly. Improper balance will cause your plane to lose control and crash. The center of gravity is located 130-150mm back from the leading edge of the wing, measured at center rib of upper wing.

2) If the nose of the plane falls, the plane is nose heavy. To correct this first move the battery pack further back in the fuselage. If this is not possible or does not correct it, stick small amounts of lead weight on the fuselage sides under the horizontal stabilizer. If the tail of the plane falls, the plane is tail heavy. To correct this, move the battery and receiver forward or if this is not possible, stick weight onto the firewall or use a brass heavy hub spinner hub, similar to those offered by Harry Higley. When balanced correctly, the airplane should sit level or slightly nose down when you lift it up with your fingers.

1.

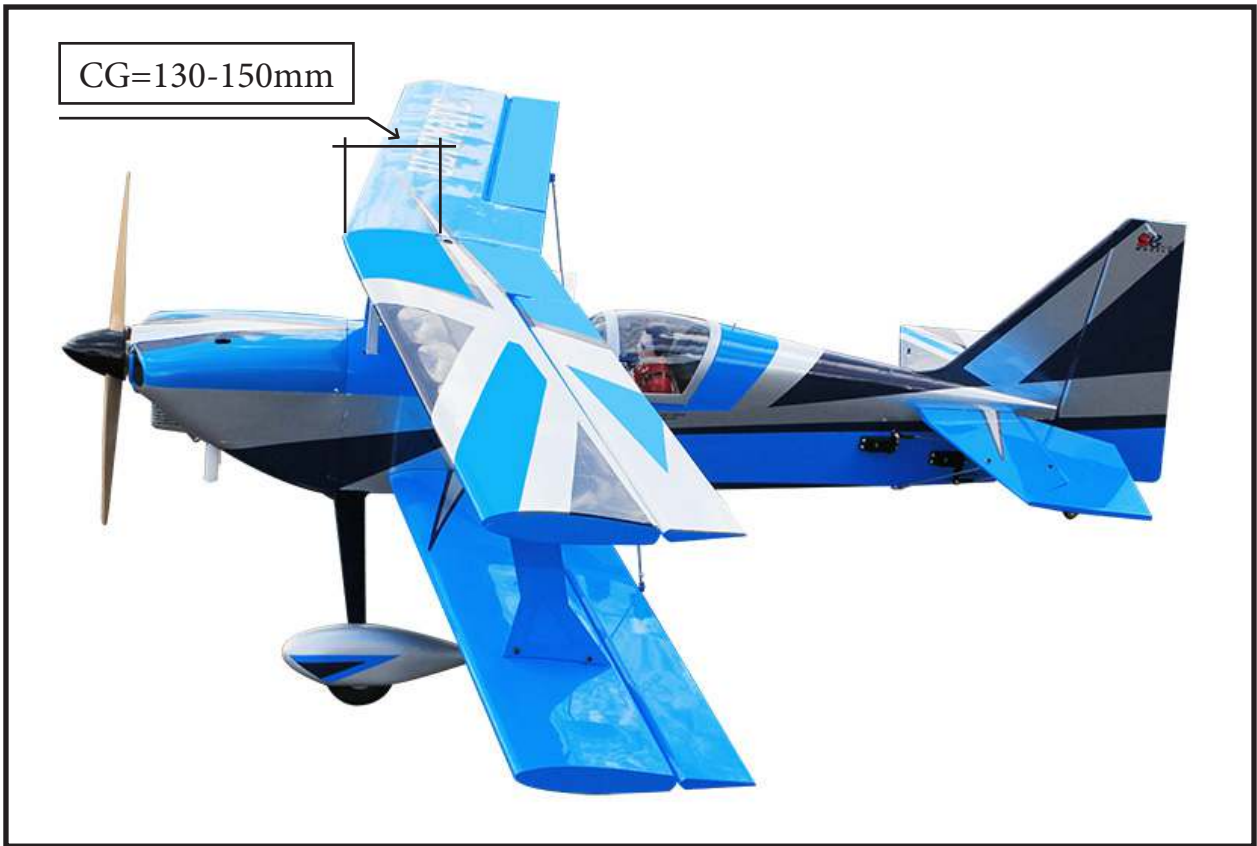

CONTROL THROWS

| | |
|------------------|----------------|
| Ailerons: | Rudder: |
| High Rate : | High Rate : |
| Up : 30 mm | Right : 100 mm |
| Down : 30 mm | Left : 100 mm |
| Low Rate : | Low Rate : |
| Up : 20 mm | Right : 60 mm |
| Down : 20 mm | Left : 60 mm |
| Elevator: | |
| High Rate : | |
| Up : 60 mm | |
| Down : 60 mm | |
| Low Rate : | |
| Up : 30 mm | |
| Down : 30 mm | |

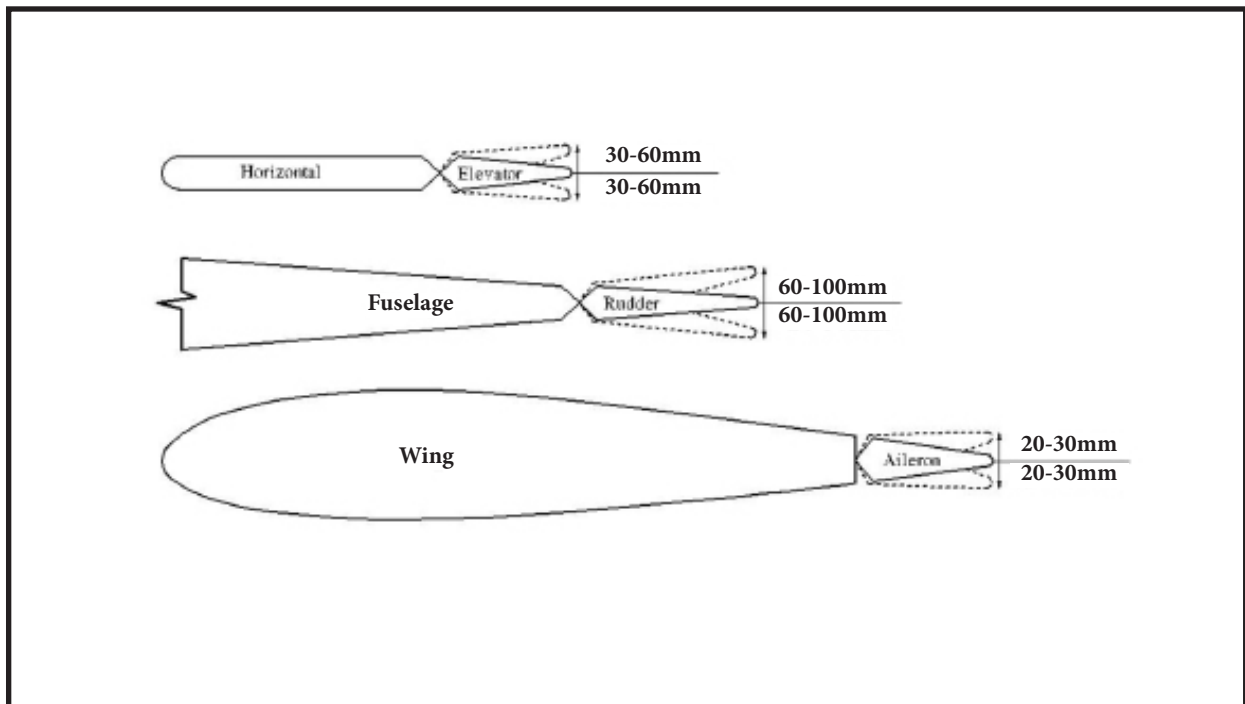

FLIGHT PREPARATION

Check the operation and direction of the elevator, rudder, ailerons and throttle.

□ A) Plug in your radio system per the manufacturer's instructions and turn everything on.

□ B) Check the elevator first. Pull back on the elevator stick. The elevator halves should move up. If they do not, flip the servo reversing switch on your transmitter to change the direction.

□ C) Check the rudder. Looking from behind the airplane, move the rudder stick to the right. The rudder should move to the right. If it does not, flip the servo reversing switch on your transmitter to change the direction.

□ D) Check the throttle. Moving the throttle stick forward should open the carburetor barrel. If it does not, flip the servo reversing switch on your transmitter to change the direction.

□ E) From behind the airplane, look at the aileron on the right wing half. Move the aileron stick to the right. The right aileron should move up and the other aileron should move down. If it does not, flip the servo reversing switch on your transmitter to change the direction.

PREFLIGHT CHECK

□ 1) Completely charge your transmitter and receiver batteries before your first day of flying.

□ 2) Check every bolt and every glue joint in the **ULTIMATE Biplane 20cc ARF** to ensure that everything is tight and well bonded.

□ 3) Double check the balance of the airplane. Do this with the fuel tank empty.

□ 4) Check the control surfaces. All should move in the correct direction and not bind in any way.

□ 5) If your radio transmitter is equipped with dual rate switches double check that they are on the low rate setting for your first few flights.

□ 6) Check to ensure the control surfaces are moving the proper amount for both low and high rate settings.

□ 7) Check the receiver antenna. It should be fully extended and not coiled up inside the fuselage.

□ 8) Properly balance the propeller. An out of balance propeller will cause excessive vibration which could lead to engine and/or airframe failure.

*We wish you many safe and enjoyable flights
with your **ULTIMATE Biplane 20cc ARF.***

*If you have any queries, or are interested in our products,
please feel free to contact us*

Factory : 12/101A - Hamlet 4 - Le Van Khuong Street - Dong Thanh Ward -
Hoc Mon District - Ho Chi Minh City - Viet Nam.

Office : 62/8 Ngo Tat To Street - Ward 19 - Binh Thanh District - Ho Chi Minh
City - Viet Nam

Phone : 848 - 86622289 or 848- 36018777

Website : www.SeagullModels.com

Email : Sales@seagullmodels.com

Facebook : www.facebook.com/SeaGullModels.