



SHOCK•CUB

35-55cc

Code : SEA 357

ASSEMBLY MANUAL

“Graphics and specifications may change without notice”.



Specifications:

Wingspan-----	102.0 in (259.0 cm).
Wing area-----	1802.7 sq.ins (1163.0 sq.dm).
Weight-----	21.0 lbs (9.6 kg).
Length-----	68.2 in (173.3 cm).
Engine/Motor size-----	35-55cc gasoline.
Radio-----	7 channels with 8 servos.

INTRODUCTION

Thank you for choosing the **SHOCK CUB 35-55cc** ARTF by **SG MODELS**. The **SHOCK CUB 35-55cc** was designed with the intermediate/advanced sport flyer in mind. It is a semi scale airplane which is easy to fly and quick to assemble. The airframe is conventionally built using balsa, plywood to make it stronger than the average ARTF, yet the design allows the aeroplane to be kept light. You will find that most of the work has been done for you already. The motor mount has been fitted and the hinges are pre-installed. Flying the **SHOCK CUB 35-55cc** is simply a joy.

This instruction manual is designed to help you build a great flying aeroplane. Please read this manual thoroughly before starting assembly of your **SHOCK CUB 35-55cc**. Use the parts listing below to indentify all parts.

WARNING

Please be aware that this aeroplane is not a toy and if assembled or used incorrectly it is capable of causing injury to people or property. WHEN YOU FLY THIS AEROPLANE YOU ASSUME ALL RISK & REPONSIBILITY.

If you are inexperienced with basic R/C flight we strongly recommend you contact your R/C supplier and join your local R/C model Flying Club. R/C Model Flying Clubs offer a variety of training procedures designed to help the new pilot on his way to successful R/C flight. They will also be able to advise on any insurance and safety regulations that may apply.

KIT CONTENTS

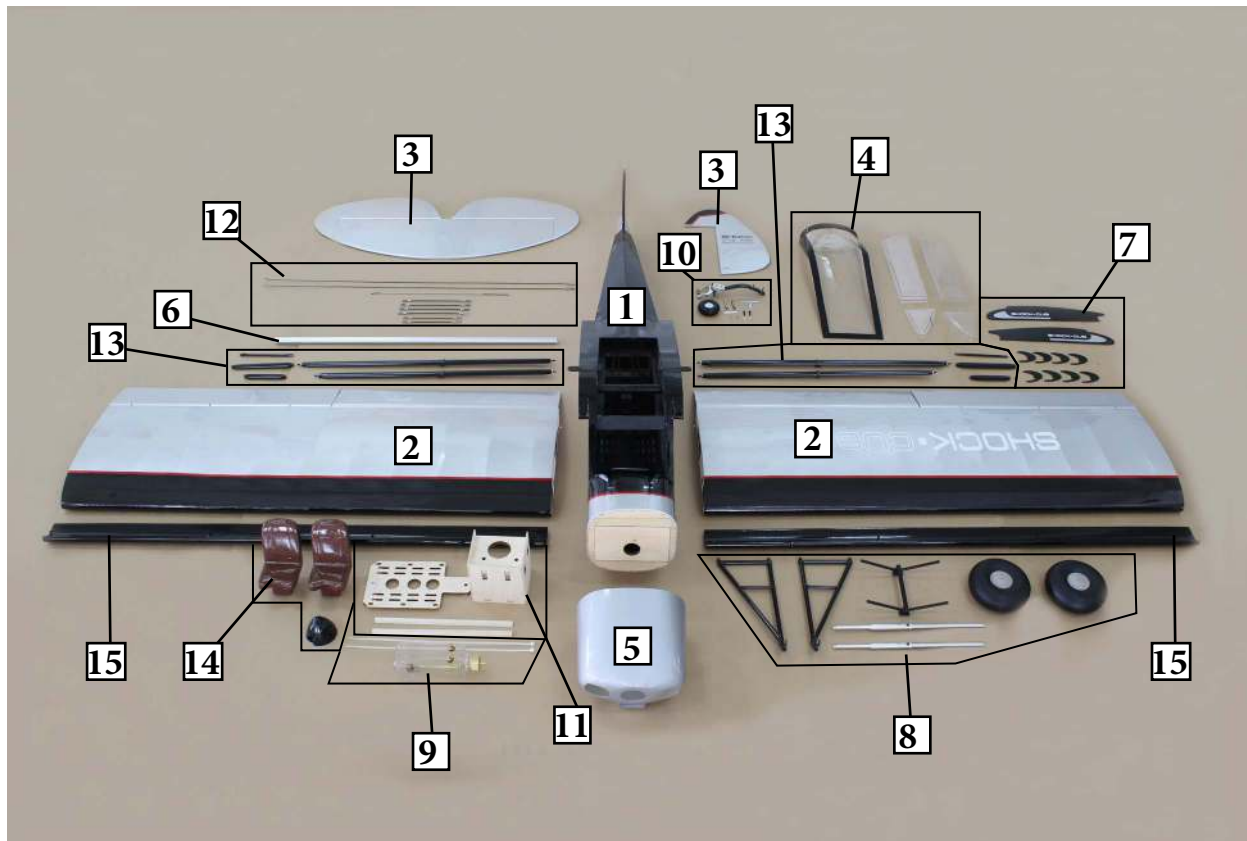

KIT CONTENTS

SEA 357 SHOCK CUB 35-55cc

1. Fuselage
2. Wing set (2)
3. Tail set (2)
4. Canopy and Window
5. Cowling
6. Wing tube
7. Wing tip
8. landing gear
9. Fuel tank
10. Tail wheel
11. Ep Motor box
12. Pushrod set
13. Wing struts (2)
14. Chair
15. Hyper-stolairfoil & high lift devices (2)

ADDITIONAL ITEMS REQUIRED

- 35-55cc gasoline engine.
- Computer radio 7 channel with 8 servos.
- Glow plug to suit engine.
- Propeller to suit engine.
- Protective foam rubber for radio system.

TOOLS & SUPPLIES NEEDED

- Thin cyanoacrylate glue.
- Medium cyanoacrylate glue.
- 30 minute epoxy.
- 5 minute epoxy.
- Hand or electric drill.
- Assorted drill bits.
- Modelling knife.
- Straight edge ruler.
- 2mm ball driver.
- Phillips head screwdriver.
- 220 grit sandpaper.
- 90° square or builder's triangle.
- Wire cutters.
- Masking tape & T-pins.
- Thread-lock.
- Paper towels.

HYPER-STOLAIRFOIL & HIGH LIFT DEVICES

Please see below pictures.

1.

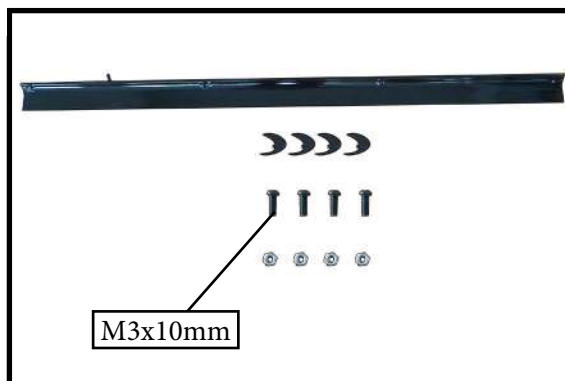

2.

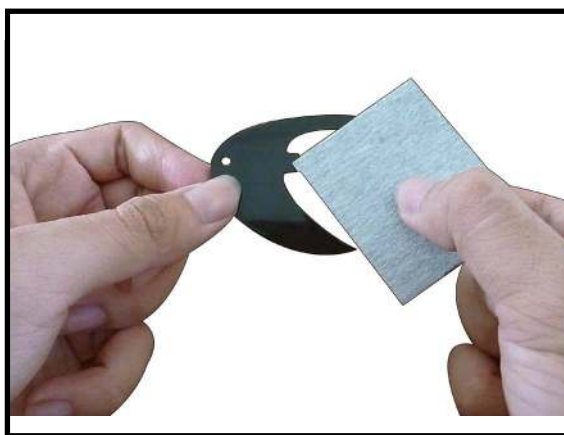

3.

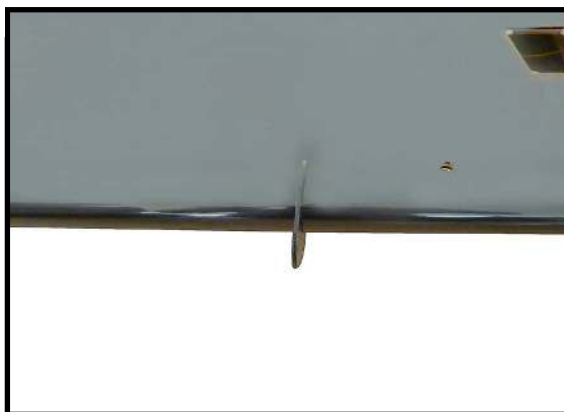

4.



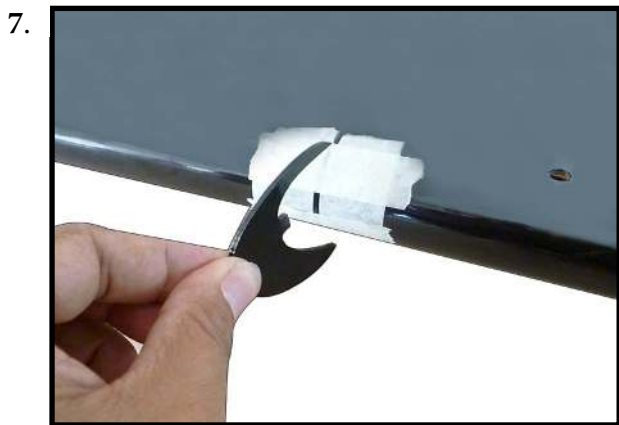
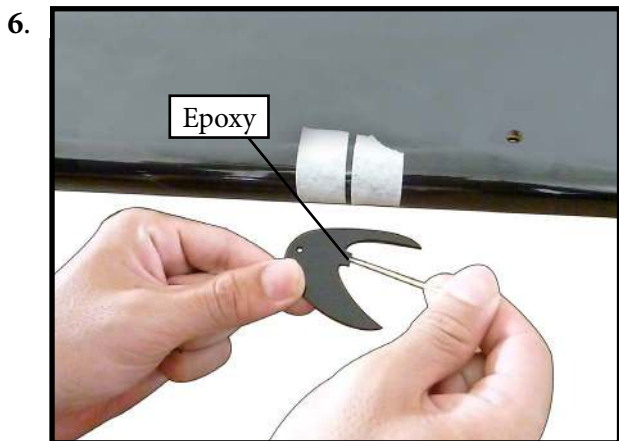
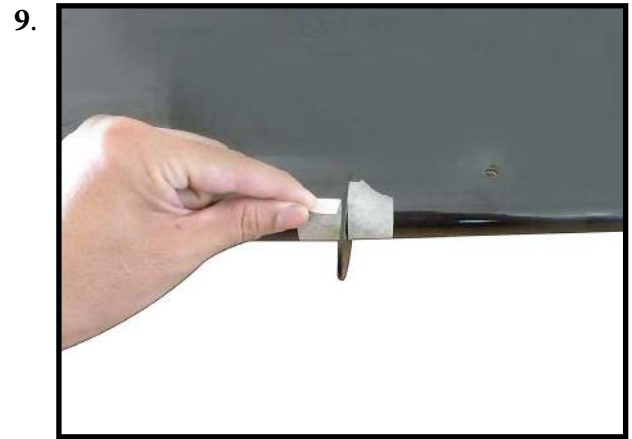
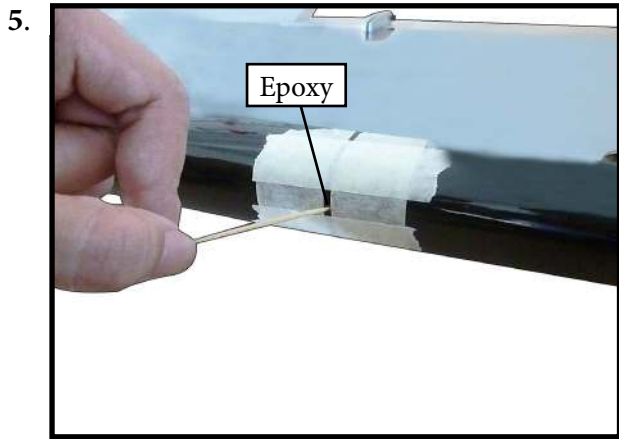

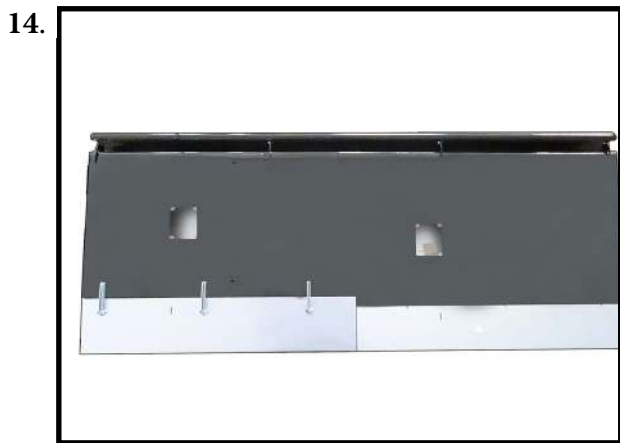

INSTALL THE AILERONS CONTROL HORN

Locate the aileron and flap control horns. The taller control horn is used for the ailerons, and the shorter horn for the flaps.

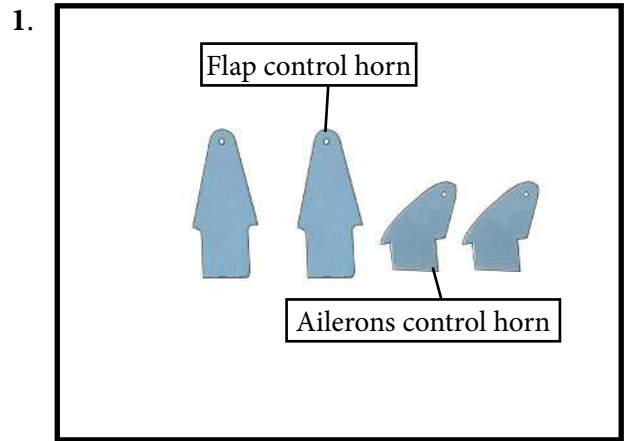

Use sandpaper to scuff the bottom of the aileron and flap control horns. Use a paper towel and isopropyl alcohol to remove any oils or debris from the control horns.

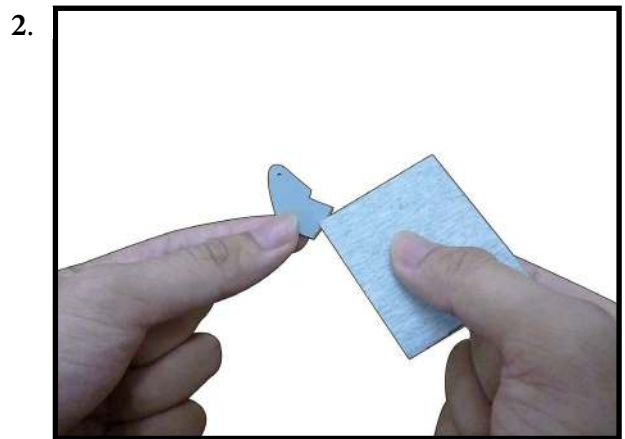

Check the fit of the control horns to the aileron and flap. They should rest flush against the control surface as shown.

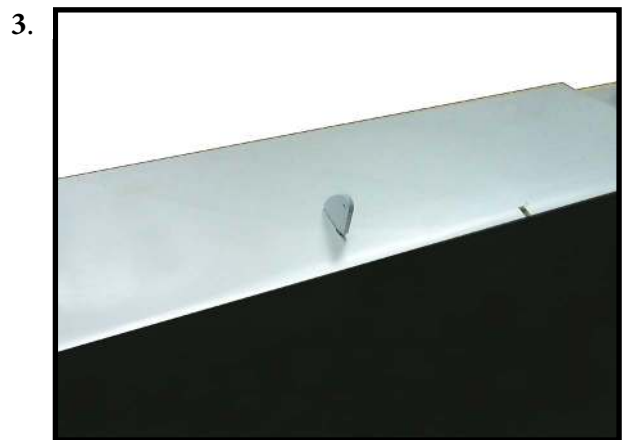

Place low-tack tape 1/32 inch (1mm) from the control horn slot. This will prevent epoxy from getting on the control surface when the control horns are glued in place.

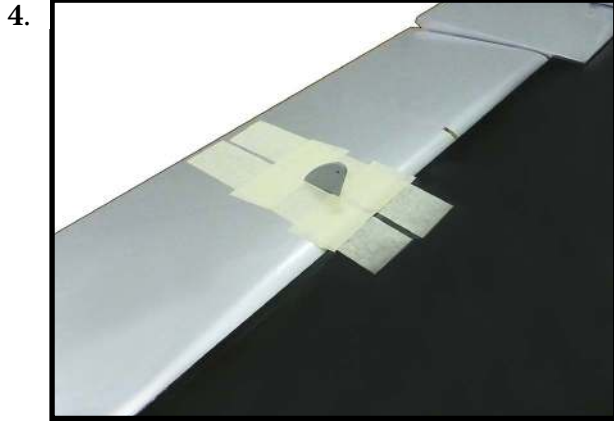

Remove the control horns from the control surfaces. Apply epoxy to the slot in the aileron and flap. Make sure the epoxy gets into the slot for a good bond between the surfaces and control horn.

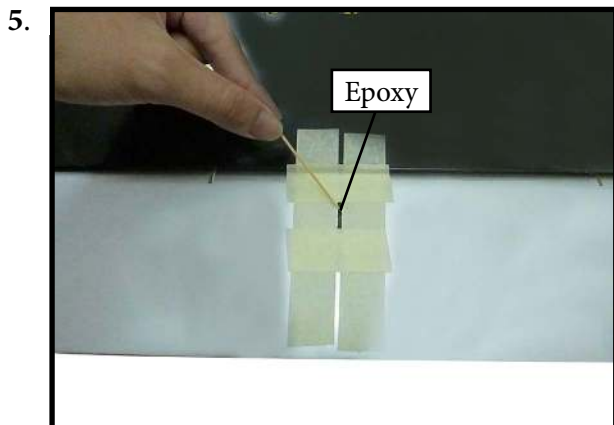

Apply epoxy to the area of the control horns that fit into the slots. Use enough epoxy so the control horns will be fully bonded to the fixed surfaces.

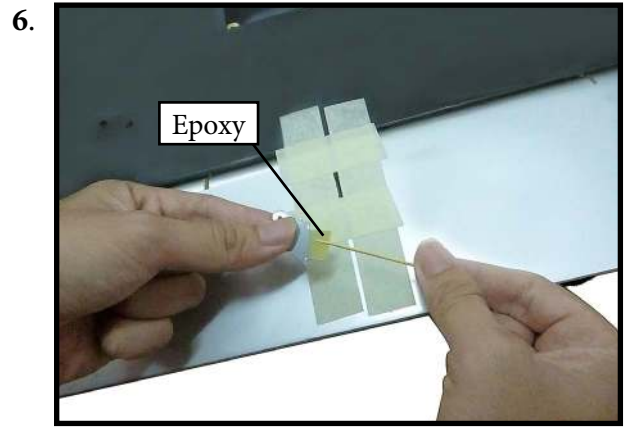

Before the epoxy fully cures, remove the tape from around the control horn. This will allow the epoxy to flow around the control horn, creating a small fillet between the control horn and surface for a finished look and secure bond.

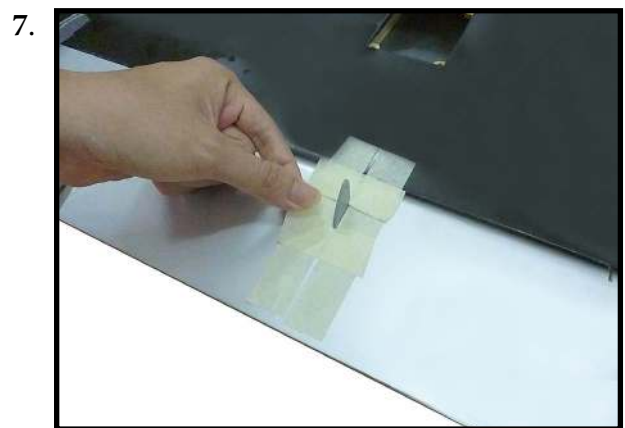

INSTALL FLAP CONTROL HORN

Install the flap control horn using the same method as same as the aileron control horns.

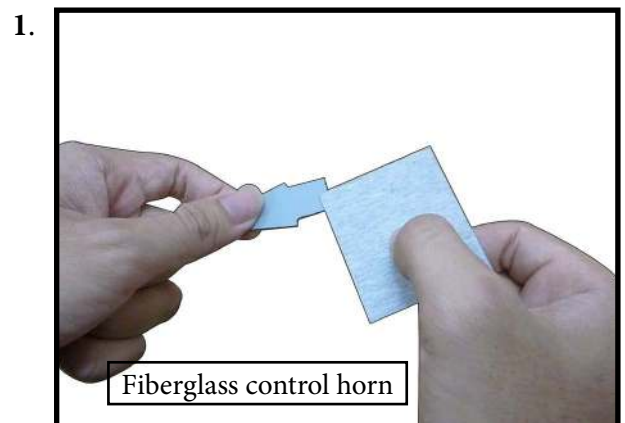

2.

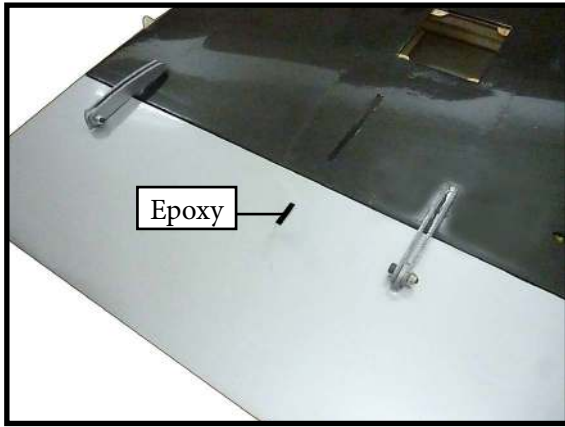

Minimum servo spec.
Torque : 122 oz-in (8.8 kg-cm) @ 6.0V;
139 oz-in (10.0 kg-cm) @ 7.4V

! Because the size of servos differ, you may need to adjust the size of the precut opening in the mount. The notch in the sides of the mount allow the servo lead to pass through.

3.

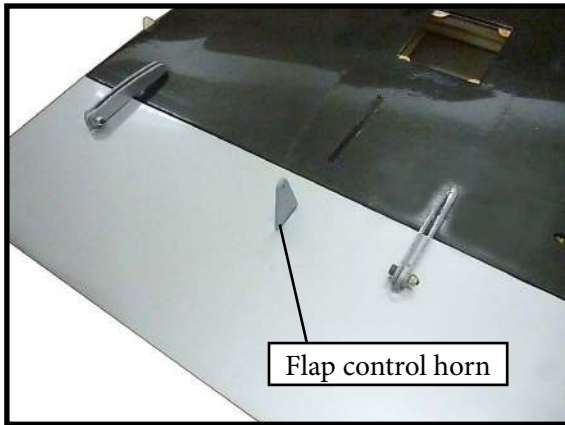

Place the servo between the mounting blocks and space it from the hatch. Use a pencil to mark the mounting hole locations on the blocks.

3.

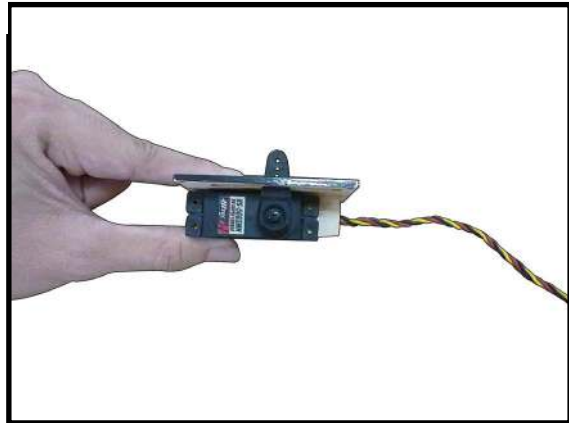

INSTALLING THE AILERON SERVOS

1.

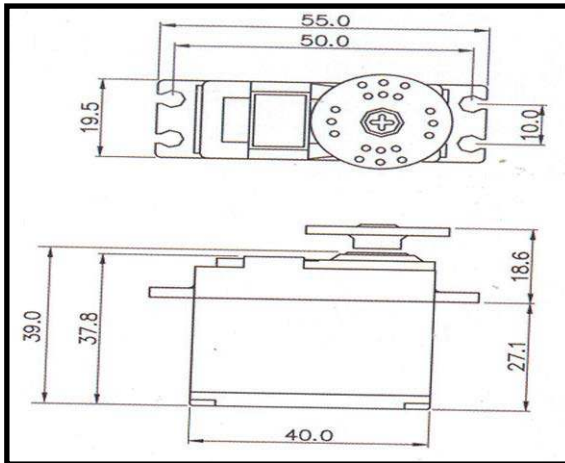

Use drill bit in a pin vise to drill the mounting holes in the blocks.

2.



4.

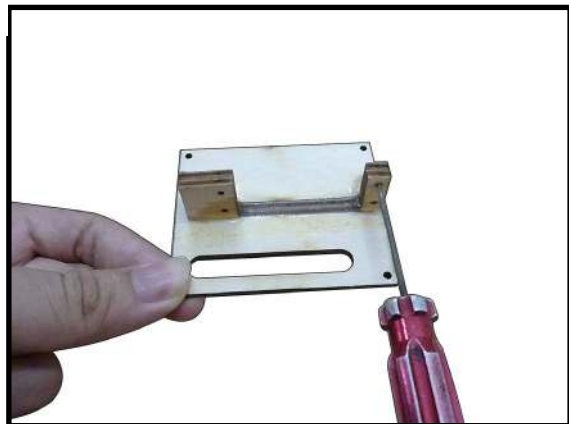

Apply 2-3 drops of thin C/A to each of the mounting holes. Allow the C/A to cure without using accelerator.

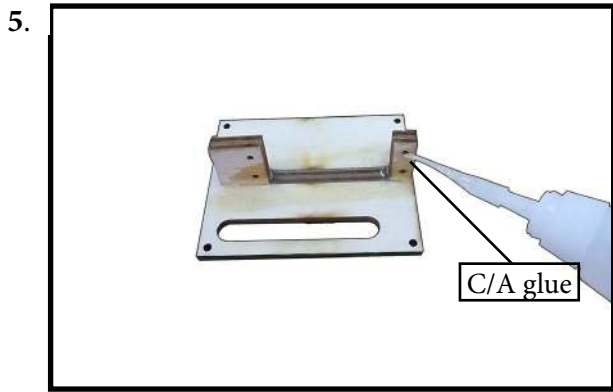

Use dental floss to secure the connection so they cannot become unplugged.

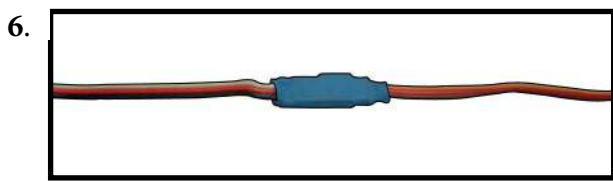

Secure the servo to the aileron hatch using Phillips screwdriver and the screws provided with the servo.



Apply 1-2 drops of thin C/A to each of the mounting tabs. Allow the C/A to cure without using accelerator.

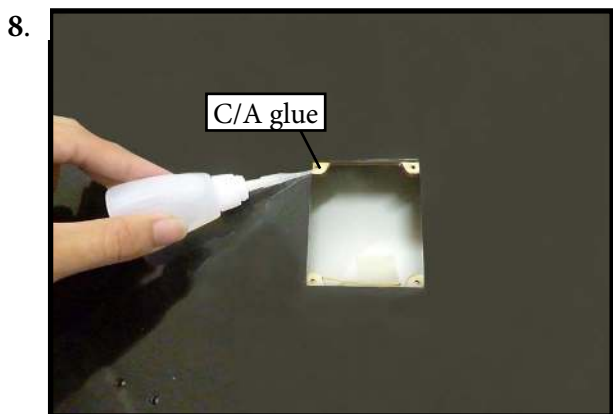

Remove the string from the wing at the servo location and use the tape to attach it to the servo extension lead. Pull the lead through the wing and remove the string.

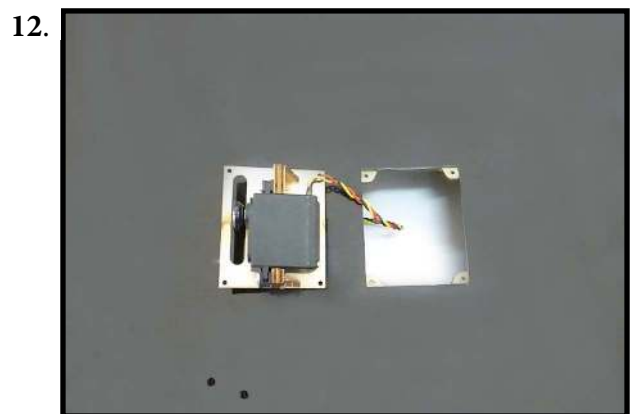
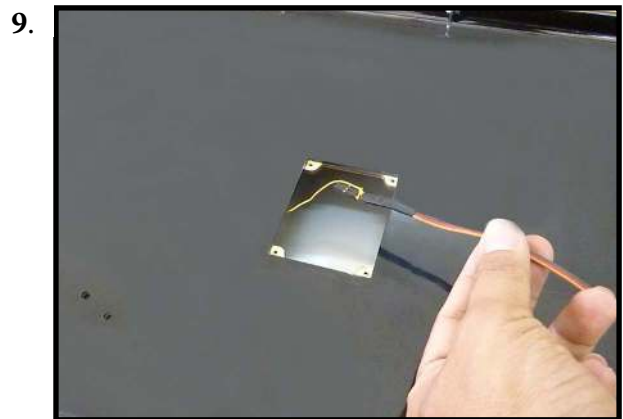

Set the aileron hatch in place and use a Phillips screw driver to install it with four wood screws.

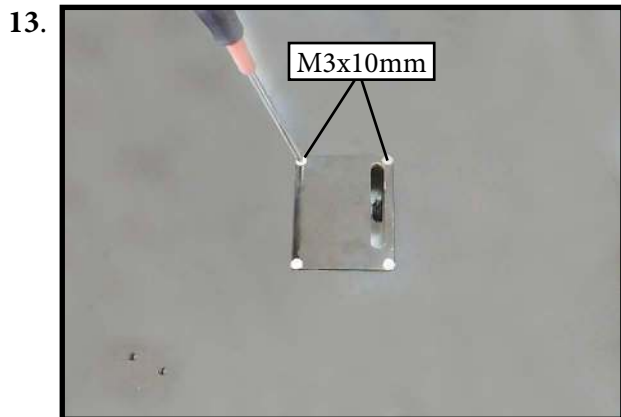

AILERON PUSHROD INSTALLATION

Please see below pictures.

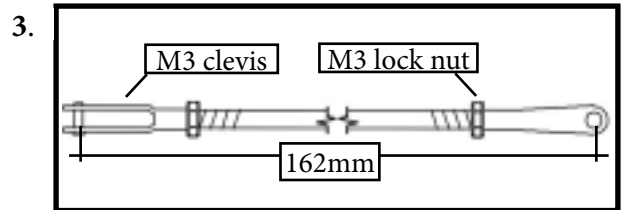
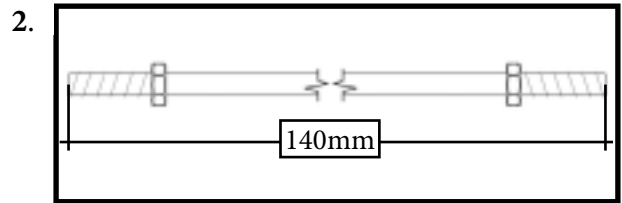
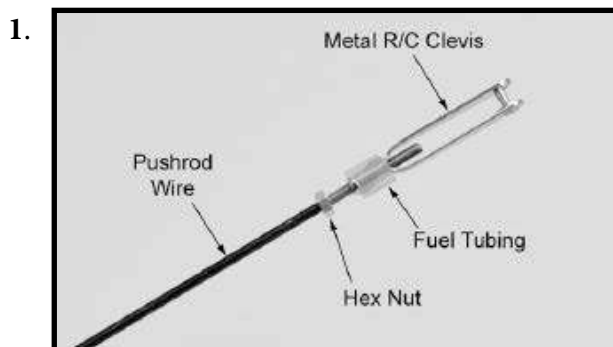

INSTALLING THE FLAP SERVO

Repeat the procedure for the flap servo.

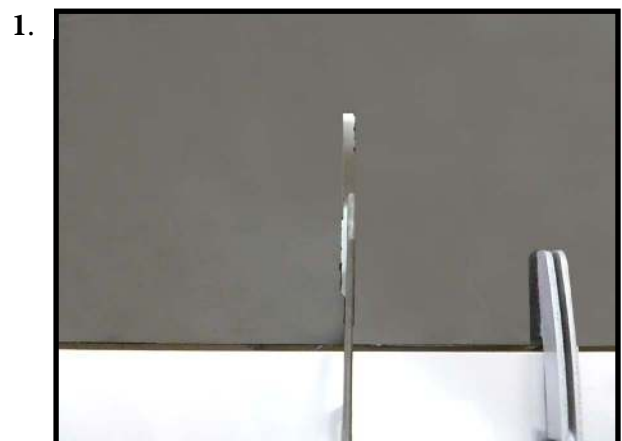

INSTALLING THE FLAP PUSHROD

Repeat the procedure for the aileron pushrod.

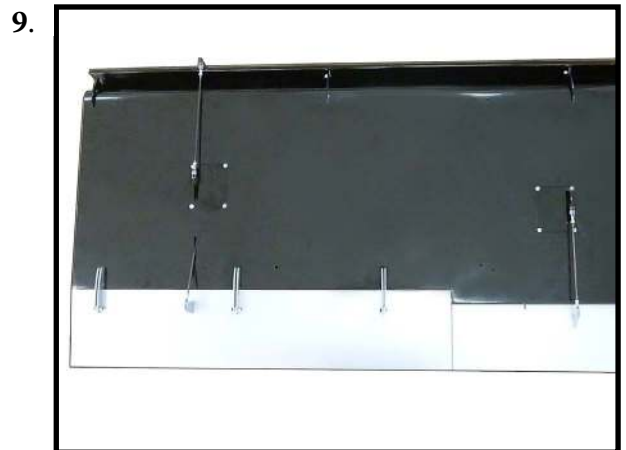
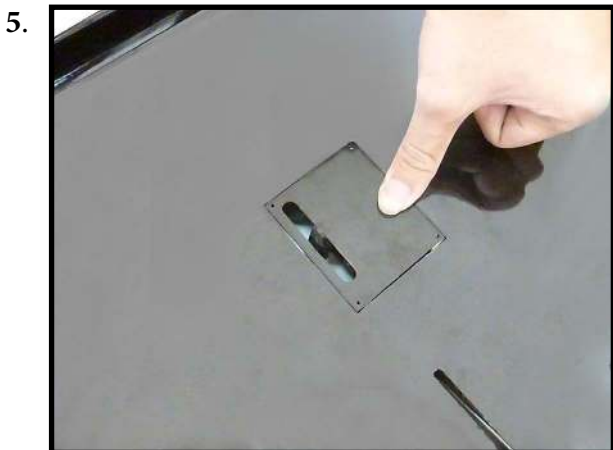
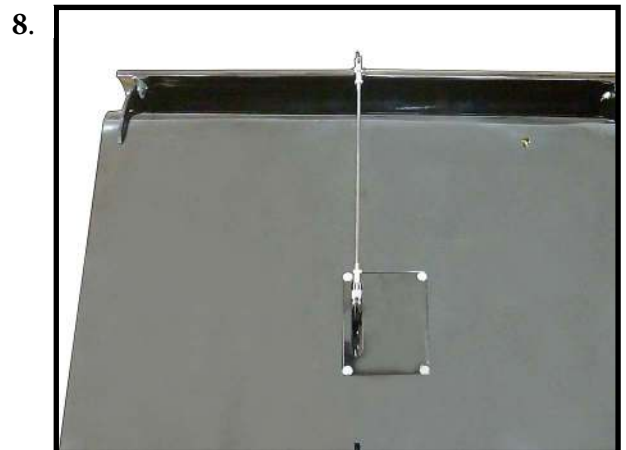
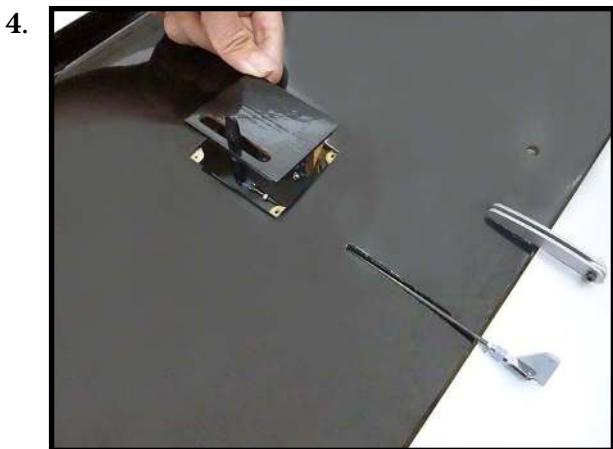
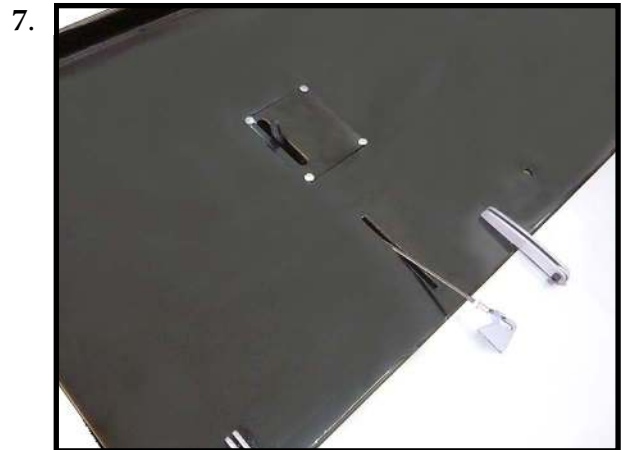
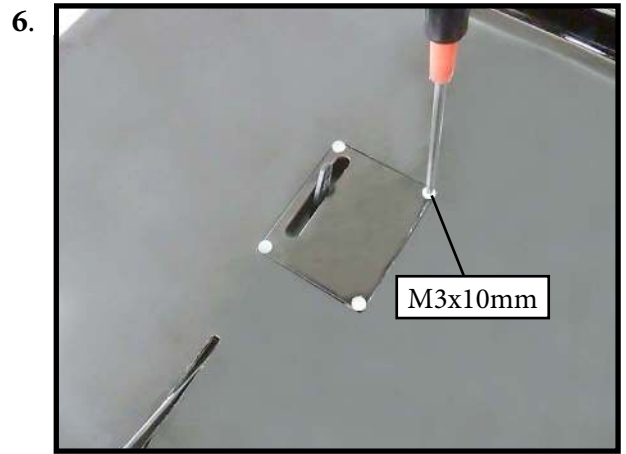
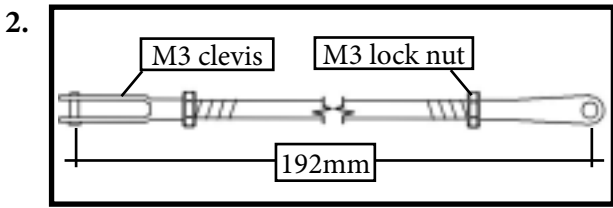
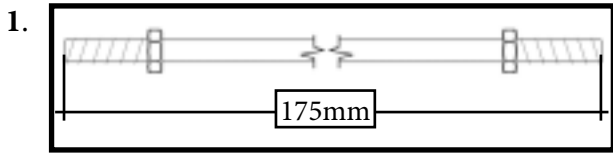

INSTALLING THE FUSELAGE SERVOS

 Because the size of servos differ, you may need to adjust the size of the precut opening in the mount. The notch in the sides of the mount allow the servo lead to pass through.

Install the rubber grommets and brass collets into all servos. Test fit the servos into the fuselage servo mounts.

Secure the servos with the screws provided with your radio system.

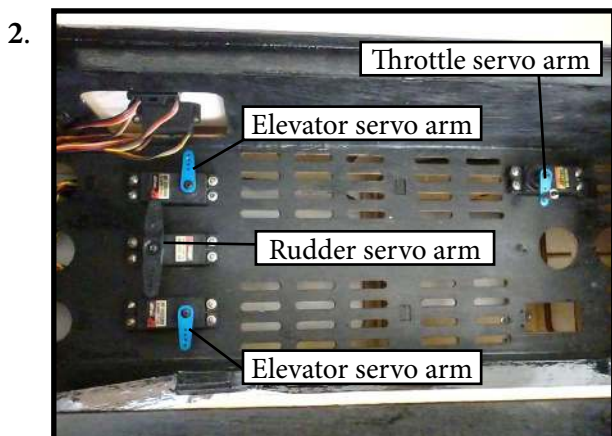
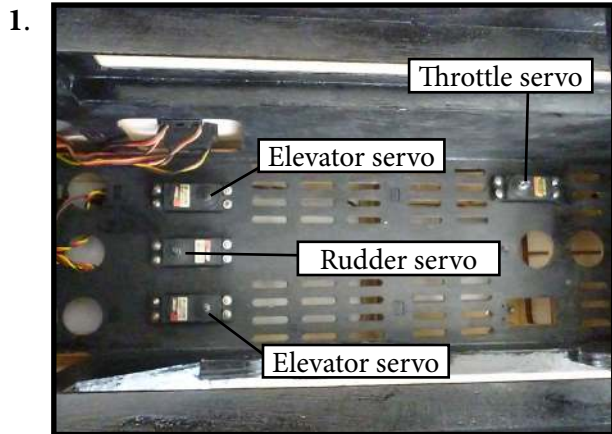

INSTALLING THE RECEIVER SWITCH

Install the switch into the precut hole in the side, in the fuselage.

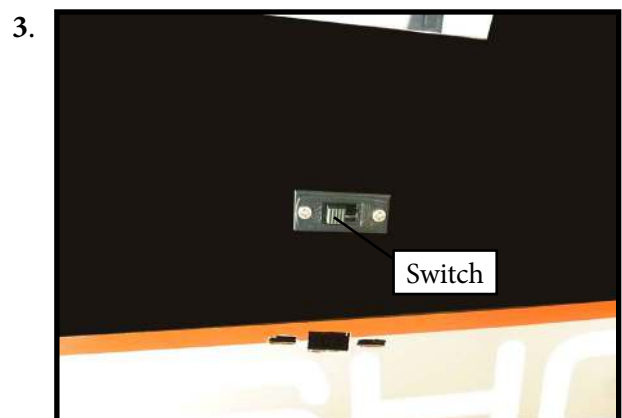
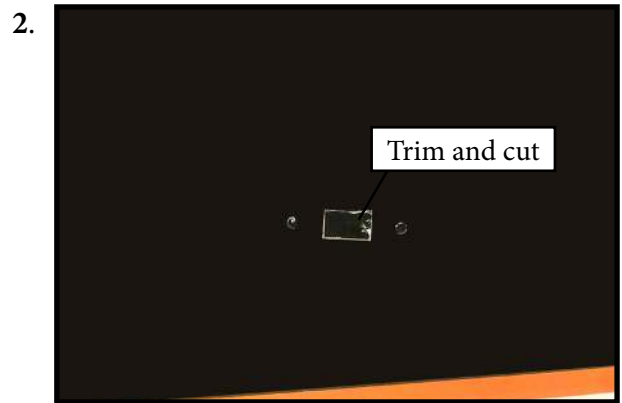
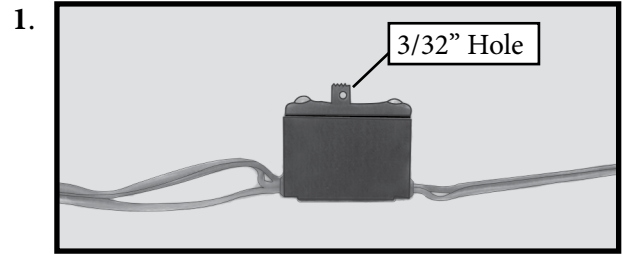

INSTALLING THE ENGINE SWITCH

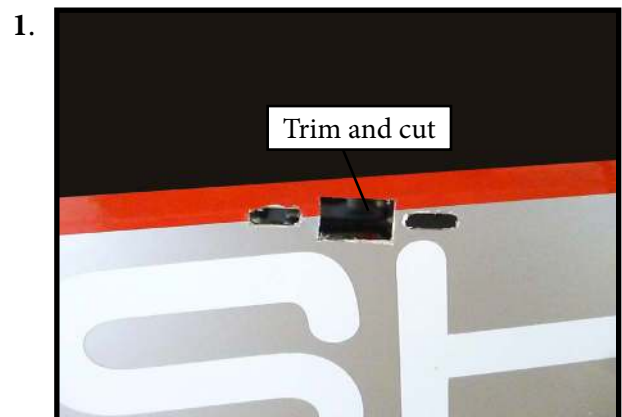

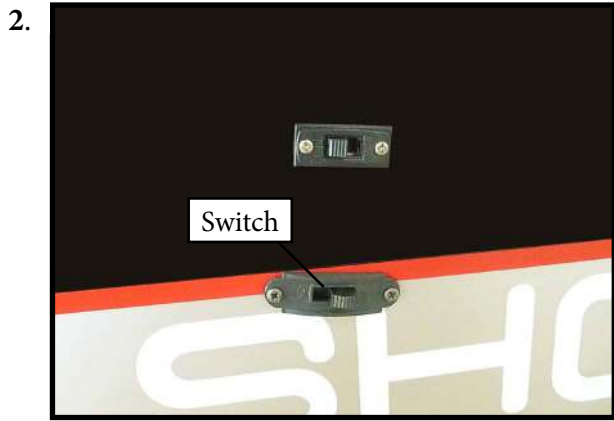

INSTALLING THE MAIN LANDING GEAR TO FUSELAGE

Please see below pictures.

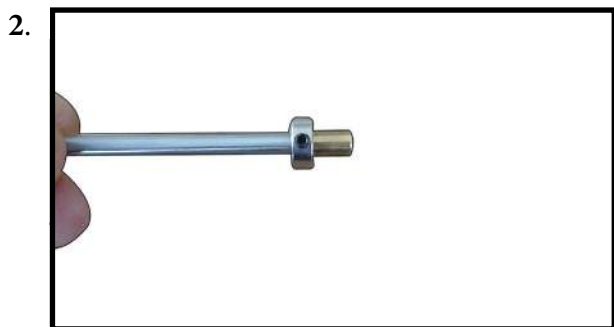

8.

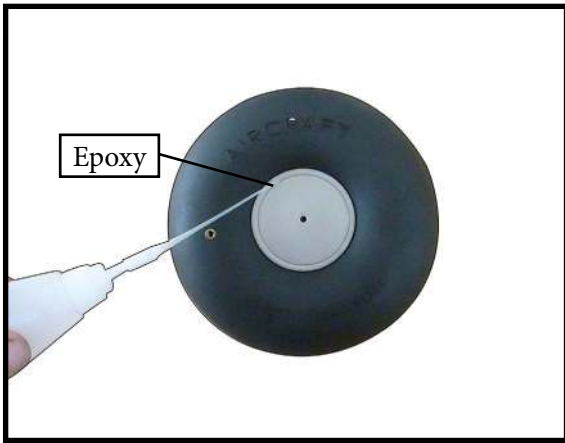

9.



10.

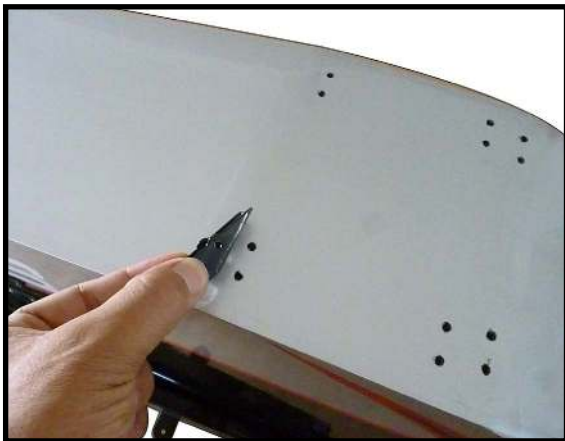

11.

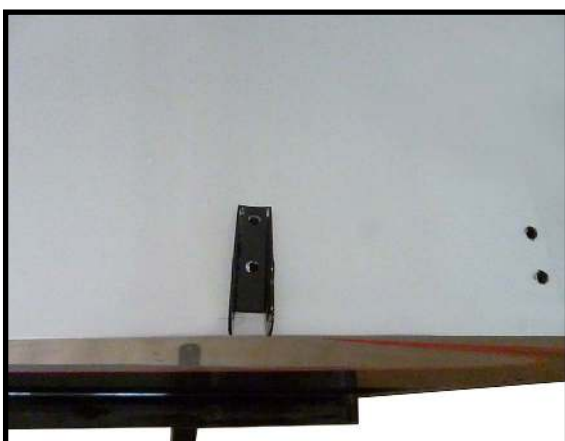

12.

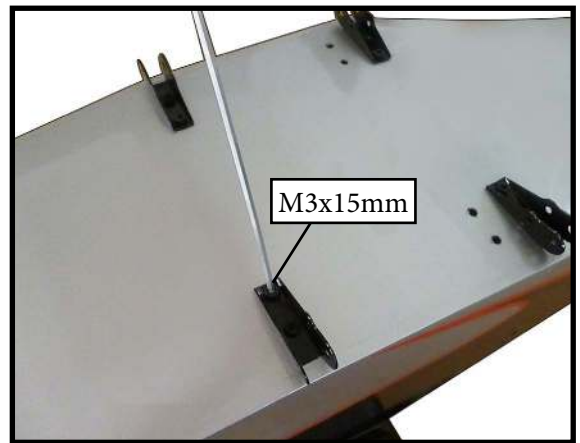

13.



14.

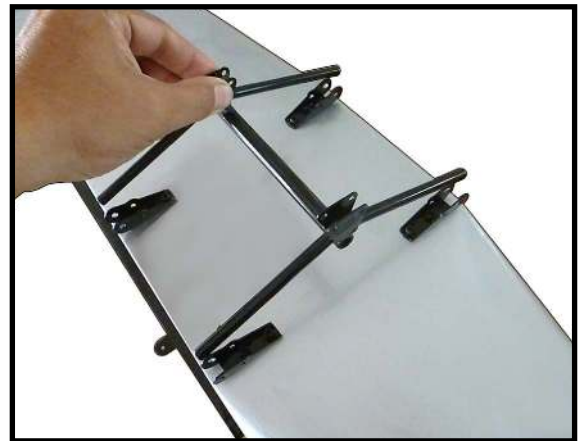

15.



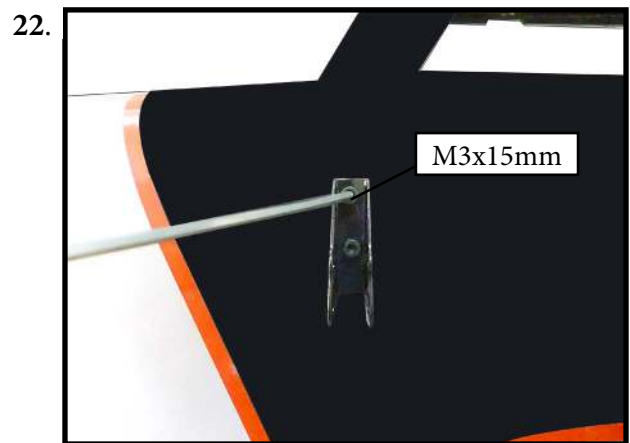
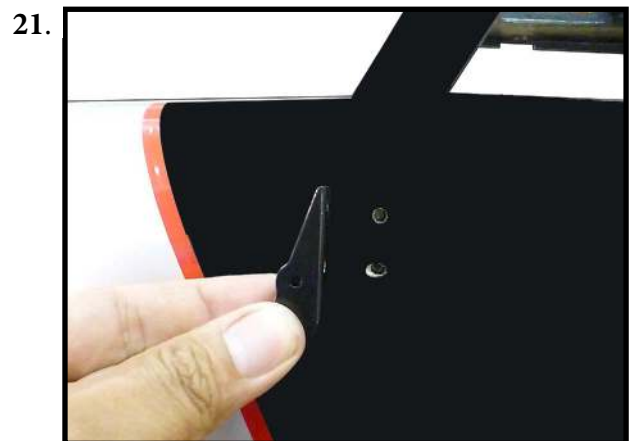
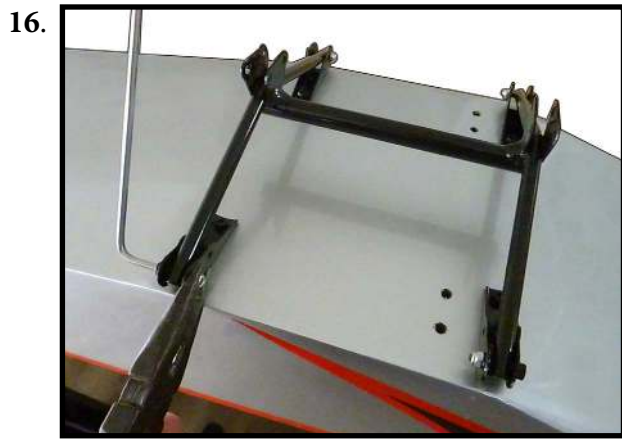

24.

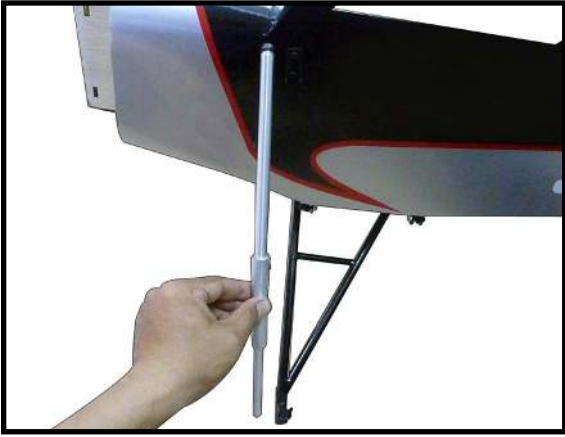

28.



25.

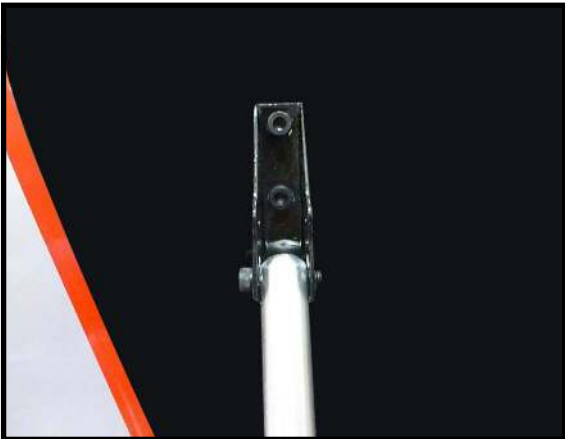

29.

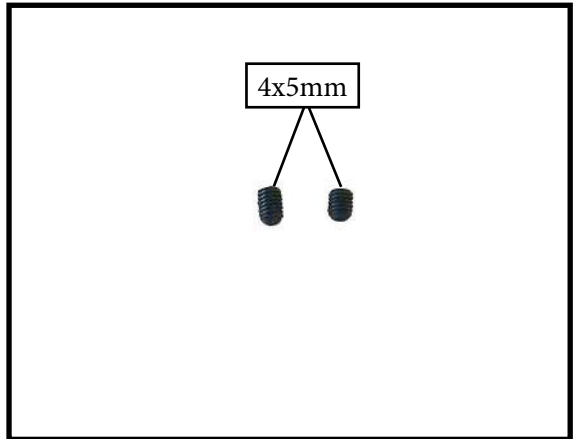

26.



30.

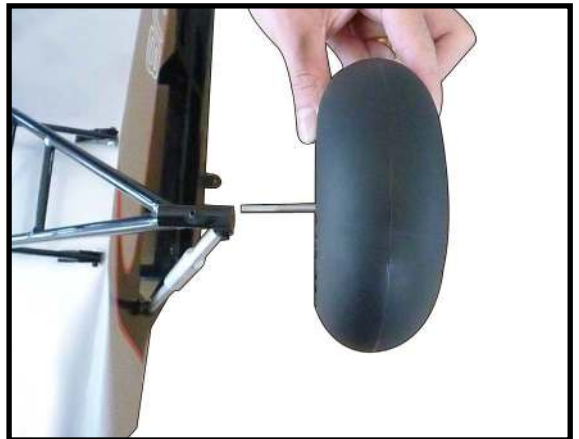

27.



31.



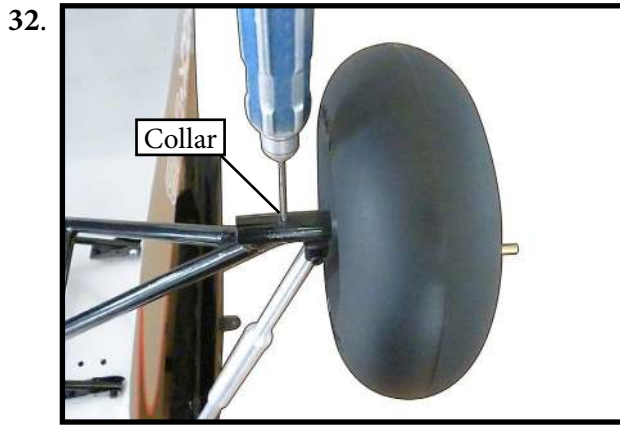

INSTALLING THE STOPPER ASSEMBLY

Using a modeling knife, carefully cut off the rear portion of one of the 3 nylon tubes leaving 1/2" protruding from the rear of the stopper. This will be the fuel pick up tube.

Using a modeling knife, cut one length of silicon fuel line. Connect one end of the line to the weighted fuel pick up and the other end to the nylon pick up tube.

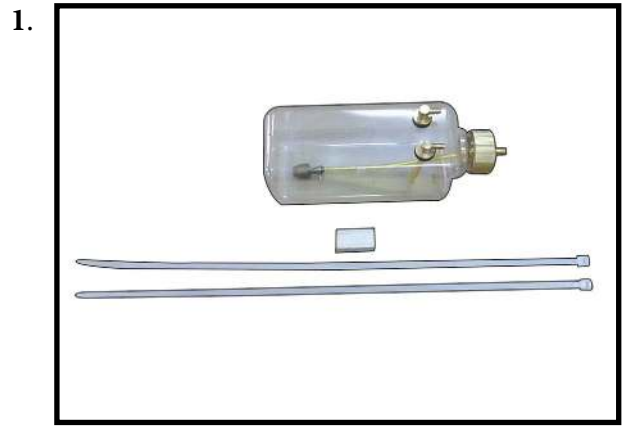

Carefully bend the second nylon tube up at a 45° angle. This tube is the vent tube.

Test fit the stopper assembly into the tank. It may be necessary to remove some of the flashing around the tank opening using a modeling knife. If flashing is present, make sure none falls into the tank.

With the stopper assembly in place, the weighted pick-up should rest away from the rear of the tank and move freely inside the tank. The top of the vent tube should rest just below the top of the tank. It should not touch the top of the tank.

When satisfied with the alignment of the stopper assembly tighten the 3 x 20mm machine screw until the rubber stopper expands and seals the tank opening. Do not over-tighten the assembly as this could cause the tank to split.

FUEL TANK INSTALLATION



 *You should mark which tube is the vent and which is the fuel pickup when you attach fuel tubing to the tubes in the stopper. Once the tank is installed inside the fuselage, it may be difficult to determine which is which.*

MOUNTING THE ENGINE

Please see below pictures.

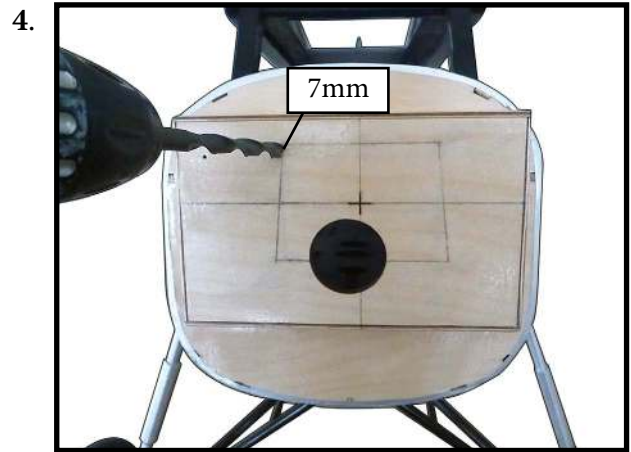
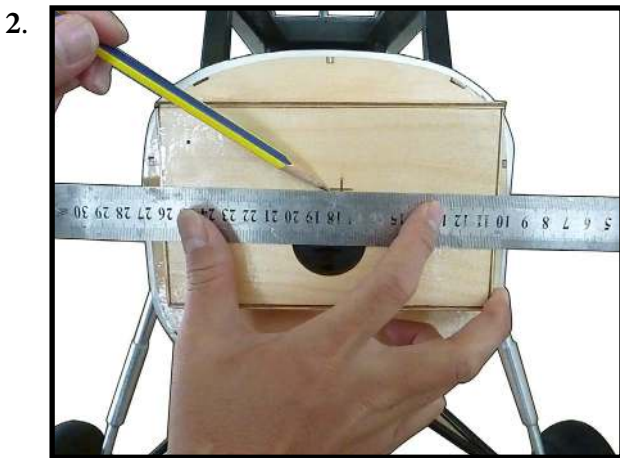
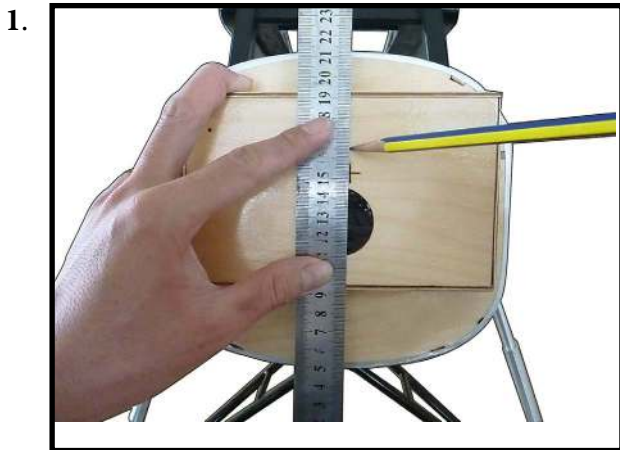

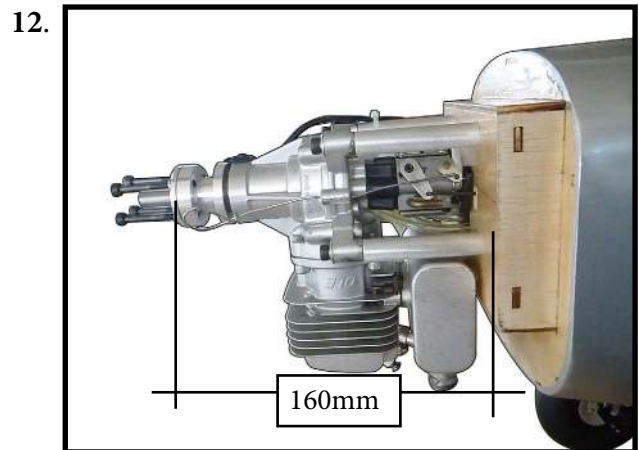
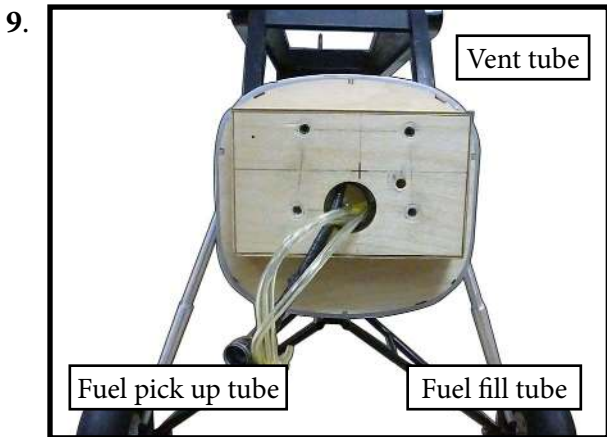
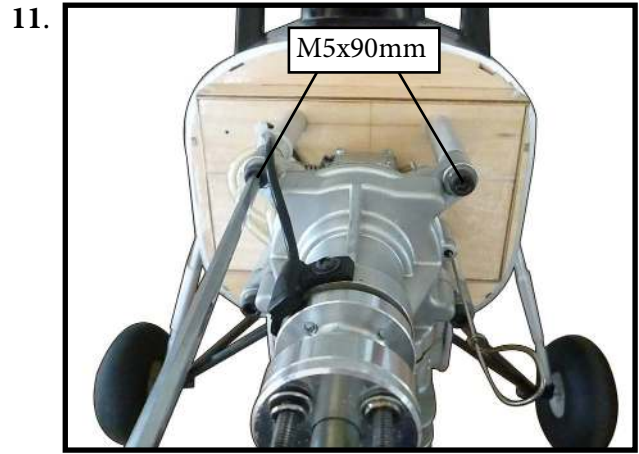

Connect the lines from the tank to the engine and muffler. The vent line will connect to the muffler and the line from the clunk to the carburetor.

! *Blow through one of the lines to ensure the fuel lines have not become kinked inside the fuel tank compartment. Air should flow through easily.*

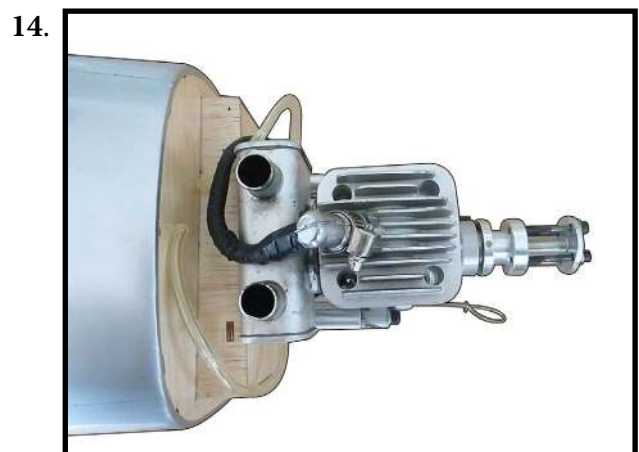
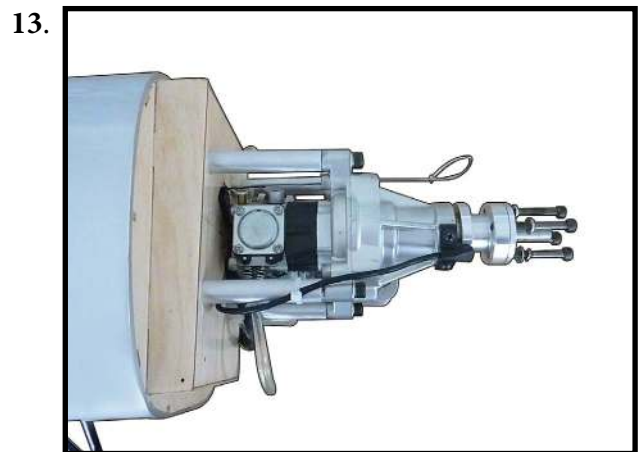

COWLING

Please see below pictures.



Tape the cowl to the fuselage using low-tack tape.



Use a drill and drill bit to drill the holes for the cowl mounting screws. Make sure the cowl position is correct before drilling each hole.

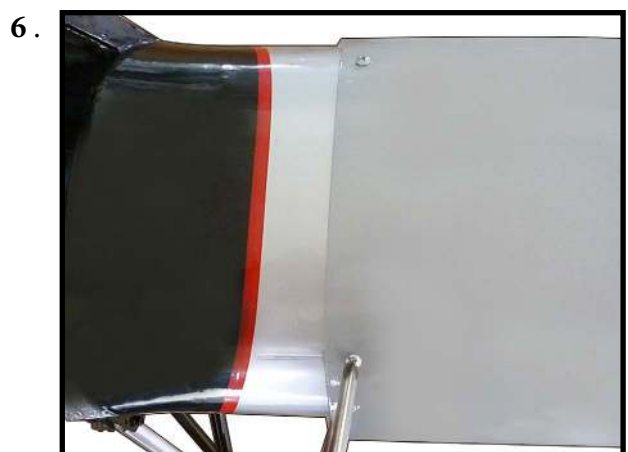
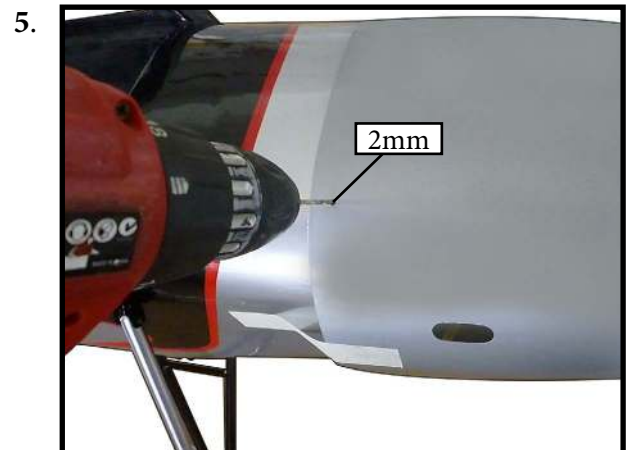

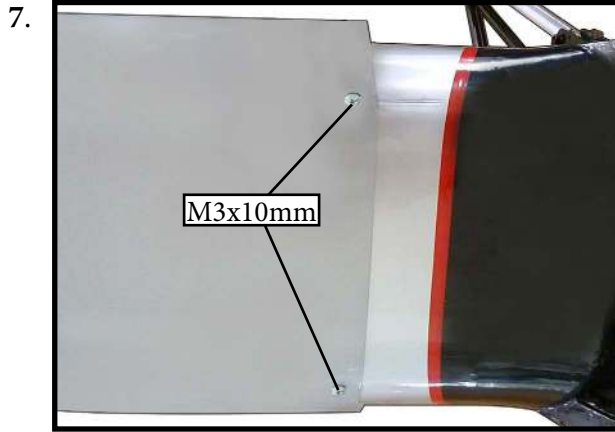

Because of the size of the cowl, it may be necessary to use a needle valve extension for the high speed needle valve. Make this out of sufficient length 1.5mm wire and install it into the end of the needle valve. Secure the wire in place by tightening the set screw in the side of the needle valve.



ELECTRIC POWER CONVERSION

Locate the items necessary to install the electric power conversion included with your model.

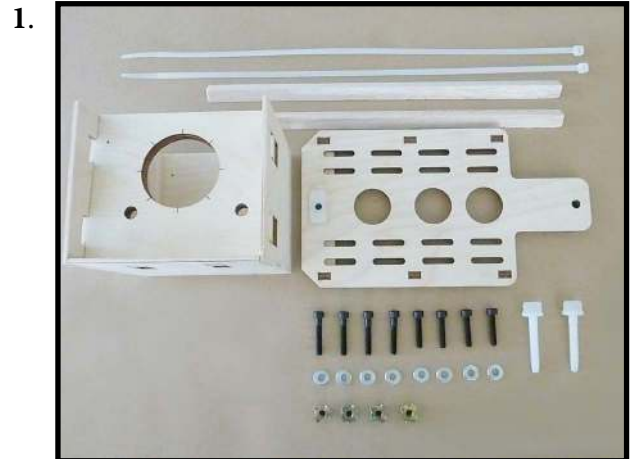

Recommend the items necessary to install the electric power conversion parts included with your model.

- **Motor: 360 - 6000 Watts**
- **Propeller: 24x10 ~ 25x12**
- **ESC: 160A - 200A**
- **12S Lipo**

Attach the electric motor box to the firewall centered with the cross lines drawn on the electric motor box and firewall. Using M5x30mm to secure the motor box to the firewall. Please see pictures below.

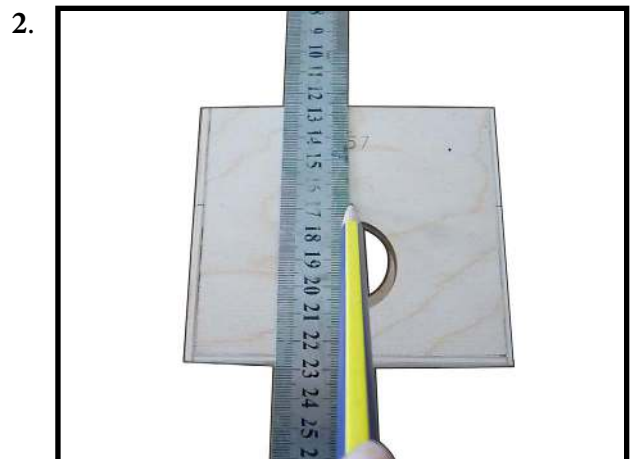

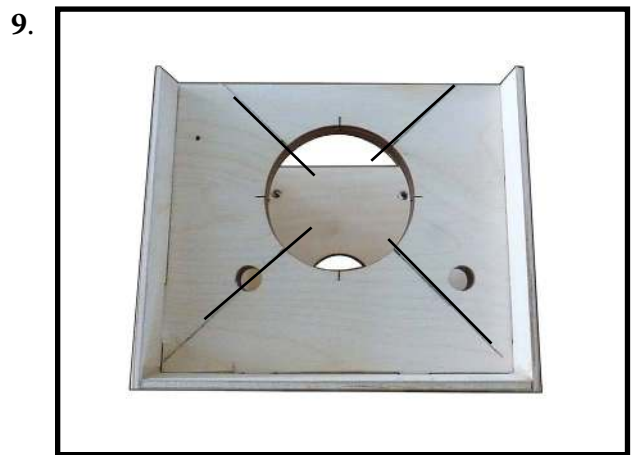
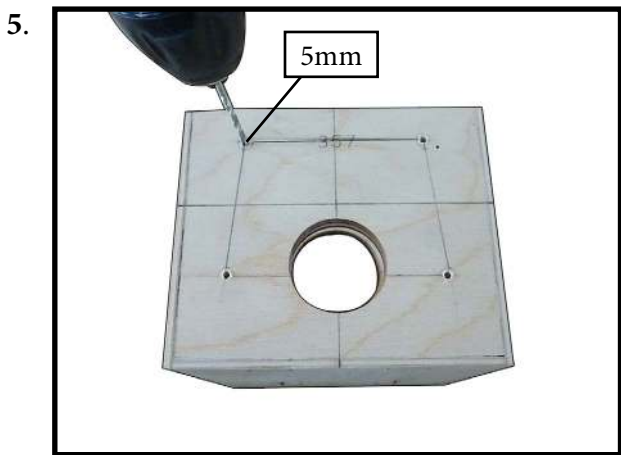
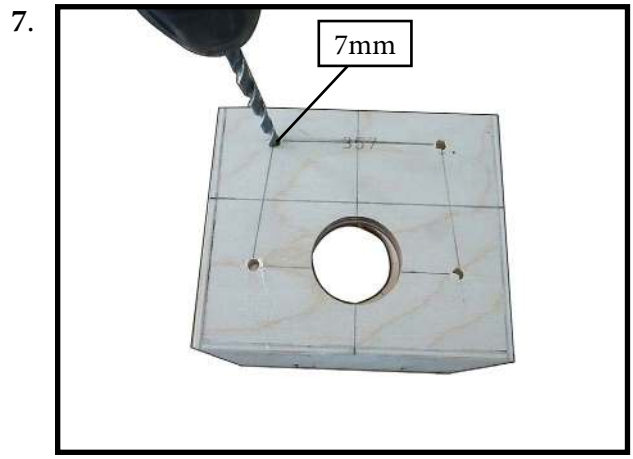
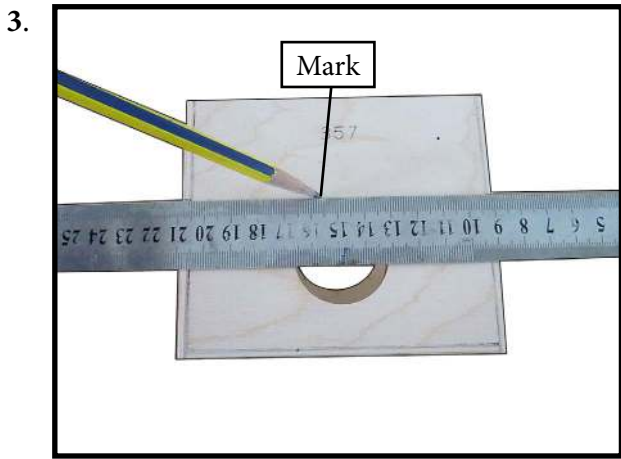

Attach the motor mount to the front of the electric motor box using four 5mm blind nut, four M5x30mm hex head bolts to secure the motor. Please see picture shown.

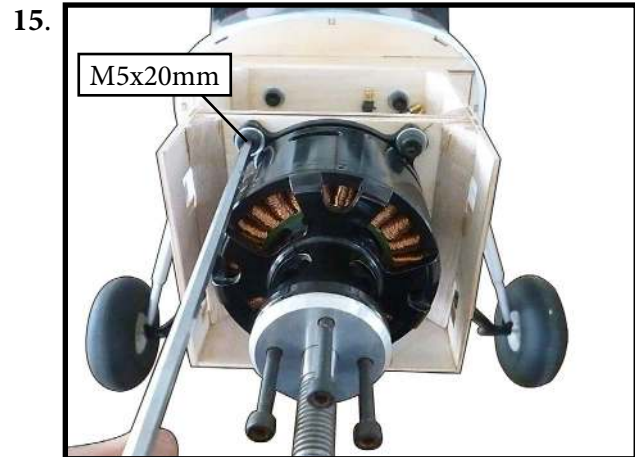
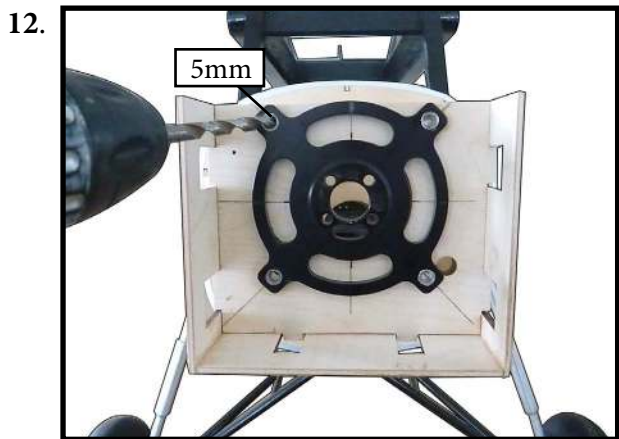
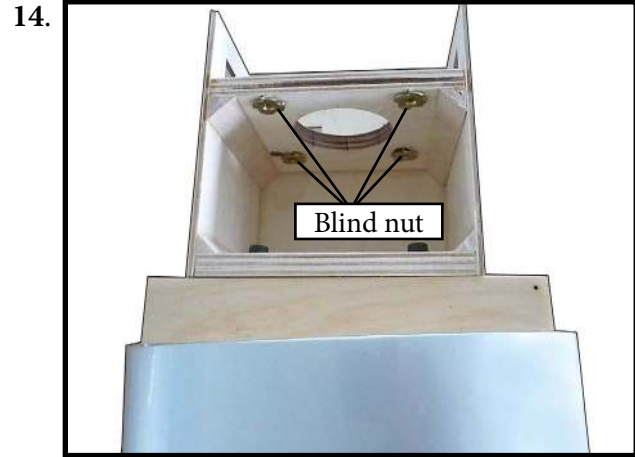
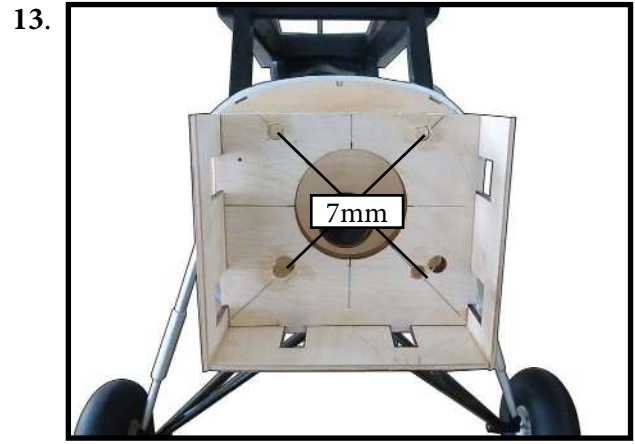
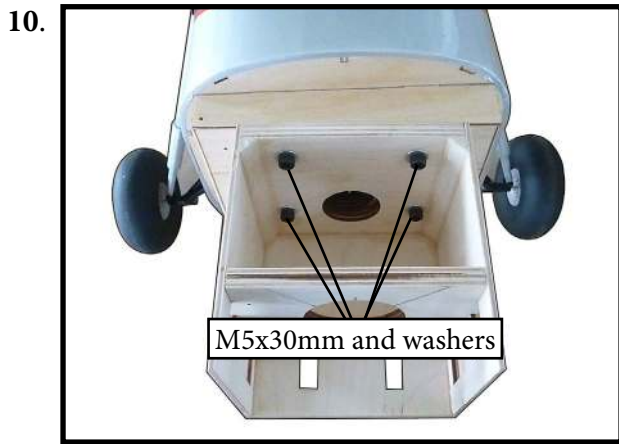

Then, use 7mm drill bit to enlarge the holes on the electric motor box.

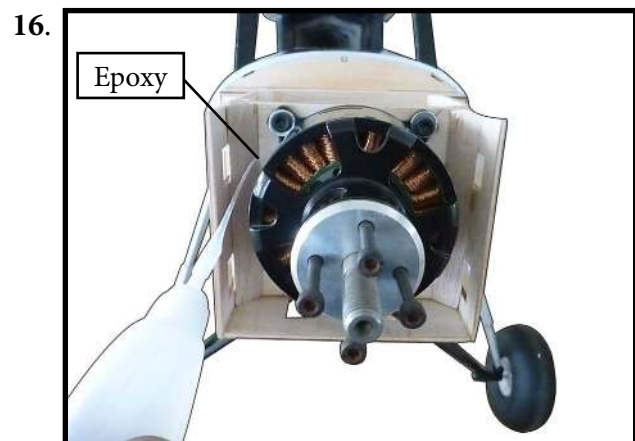

Attach the speed control to the side of the motor box using two-sided tape and tie wraps. Connect the appropriate leads from the speed control to the motor. Make sure the leads will not interfere with the operation of the motor.

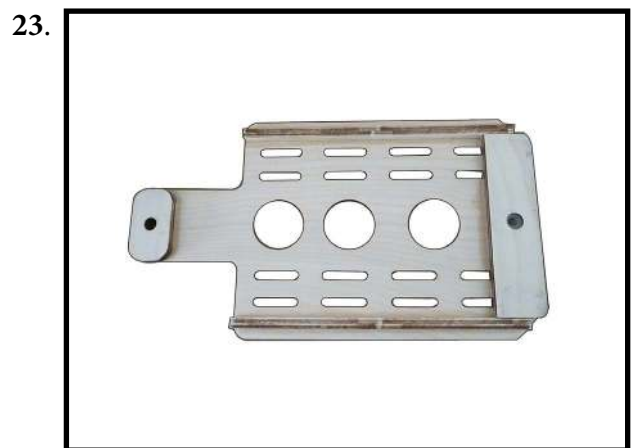
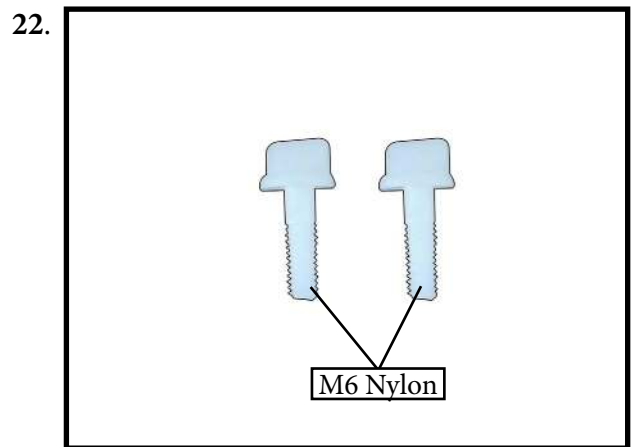
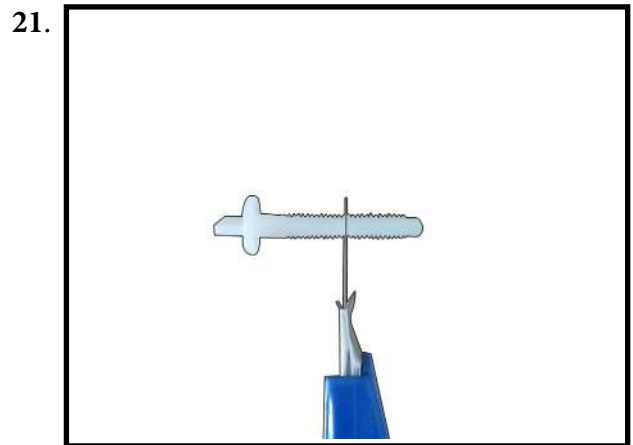
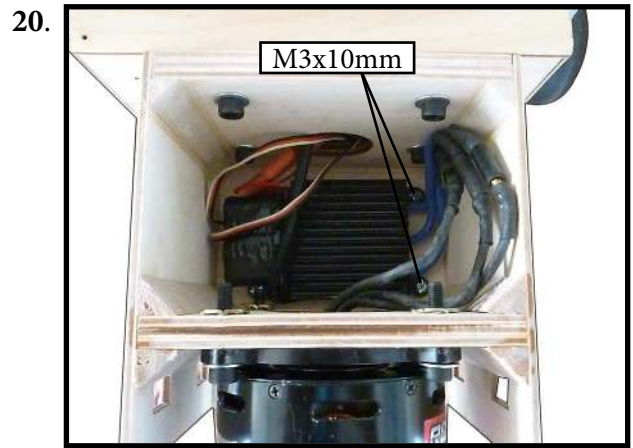
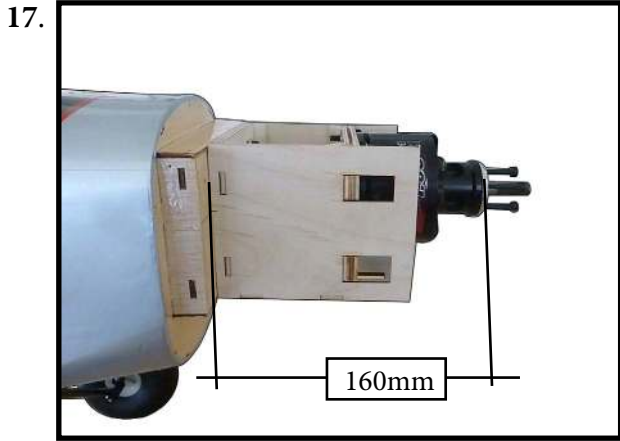

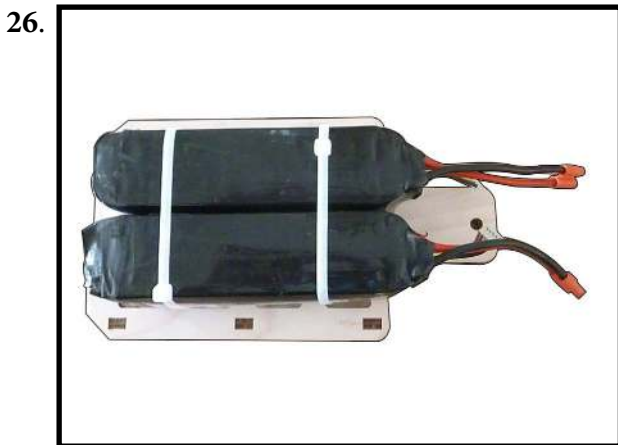
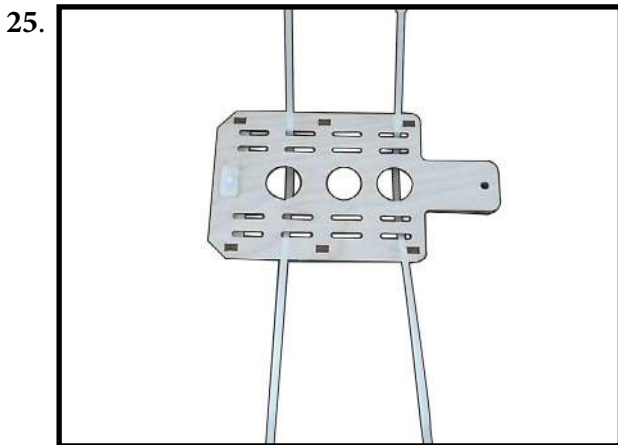

INSTALLING THE SPINNER

Install the spinner backplate, propeller and spinner cone.



 The propeller should not touch any part of the spinner cone. If it does, use a sharp modeling knife and carefully trim away the spinner cone where the propeller comes in contact with it.

2.



HINGING THE ELEVATORS

Glue the elevator hinges in place using the same techniques used to hinge the ailerons.

1.

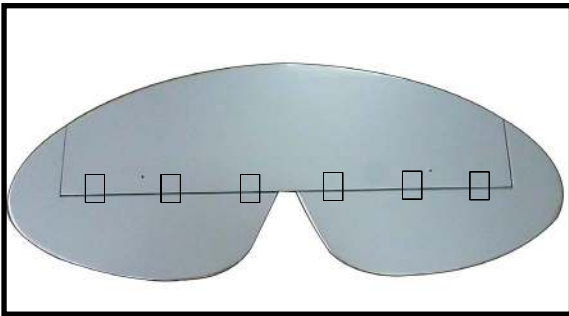

INSTALL ELEVATOR CONTROL HORN

1.

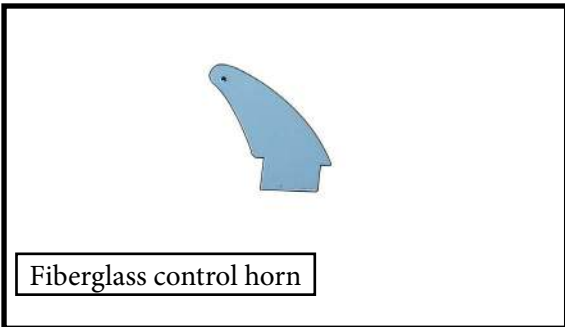

2.

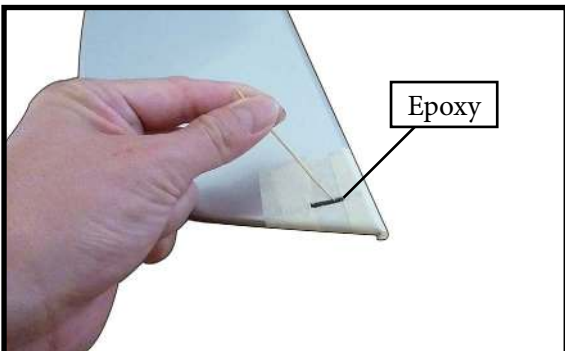

3.

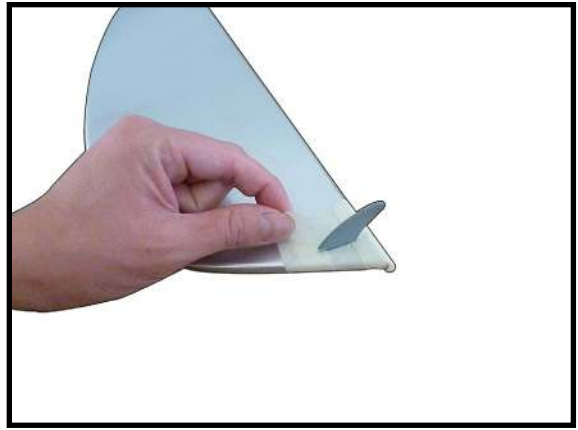

ELEVATOR AND STABILIZER INSTALLATION

1.

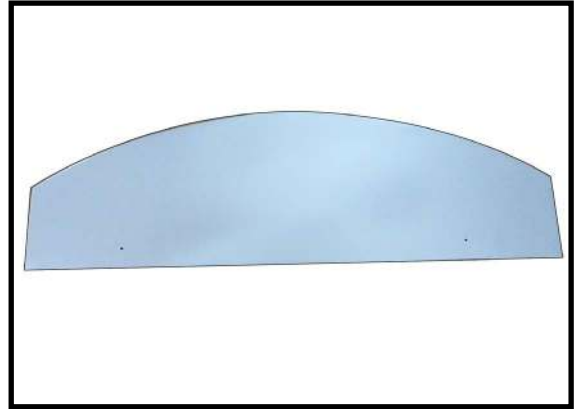

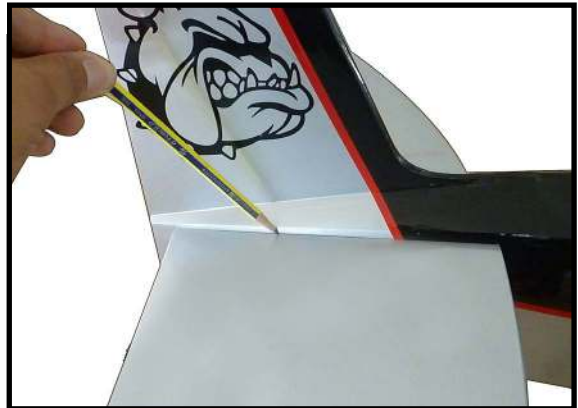

With the stabilizer held firmly in place, use a pen and draw lines onto the stabilizer where it and the fuselage sides meet. Do this on both the right and left sides and top and bottom of the stabilizer.

2.

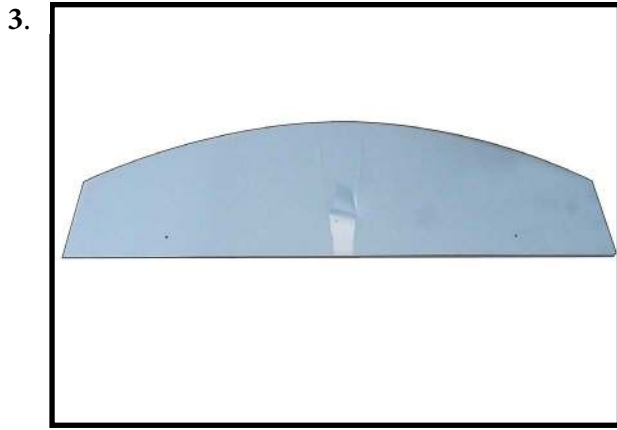

Remove the stabilizer. Using the lines you just drew as a guide, carefully remove the covering from between them using a modeling knife.



 *When cutting through the covering to remove it, cut with only enough pressure to only cut through the covering itself. Cutting into the balsa structure may weaken it.*

Using a modeling knife, carefully remove the covering that overlaps the stabilizer mounting platform sides in the fuselage. Remove the covering from both the top and the bottom of the platform sides.

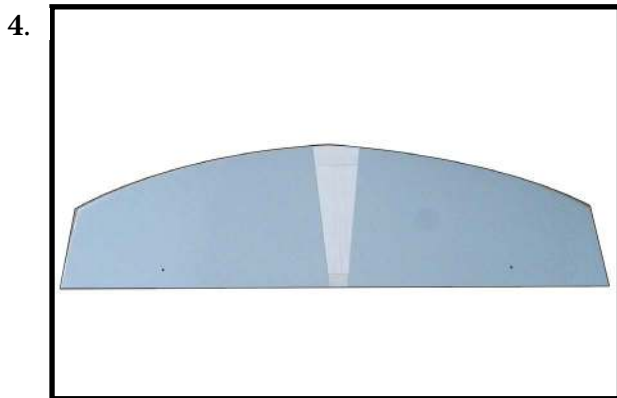

Slide the stabilizer partially into the fuselage so the wood at the center is exposed. Mix 1/2 ounce (15ml) of 30-minute epoxy. Use an epoxy brush to apply the epoxy to the exposed wood on the top of the stabilizer.

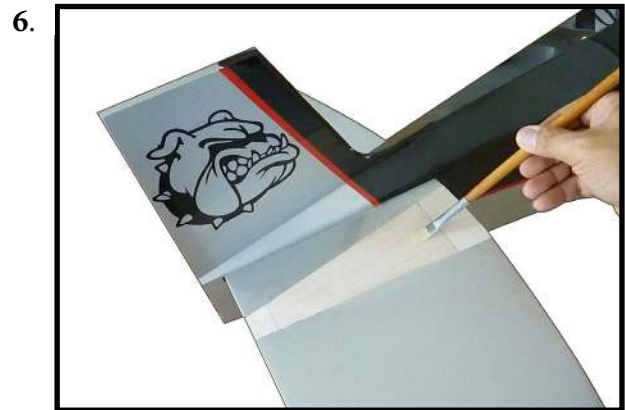

Carefully turn the model over and apply epoxy to the exposed wood on the bottom of the stabilizer. Slide the stabilizer back into position.

Use care not to get epoxy on the elevator joiner wire.

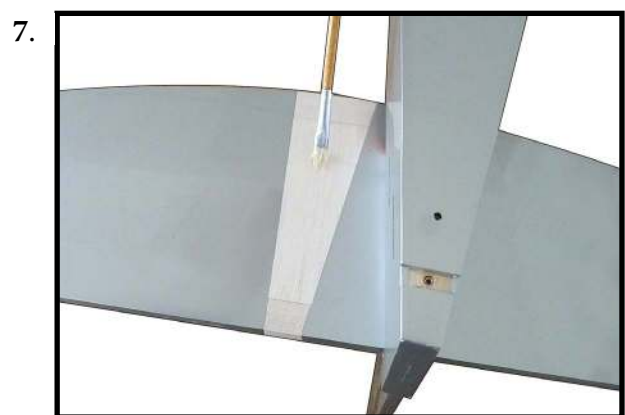

Once the alignment of the stabilizer has been verified, use a paper towel and isopropyl alcohol to remove any excess epoxy from the fuselage and stabilizer. Allow the epoxy to fully cure before proceeding.

If you find epoxy on the joiner wire, use the paper towel and isopropyl alcohol to clean the joiner.



Use a pin vise and 1/16-inch (1.5mm) drill bit to drill a hole in the center of each hinge slot to allow the CA to wick into the hinge. Drill holes in both the elevators and stabilizer surfaces at this time. Place a T-pin in the center of each hinge along side the slot in the hinge. This will help center the hinge when it is placed in the elevators. Slide the hinges into position with the T-pin resting against the edge of the control surface.

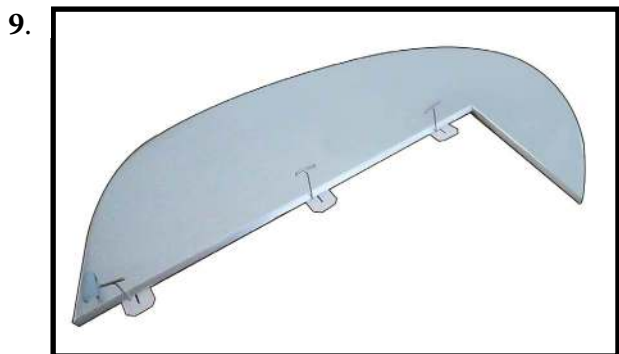

Fit the elevator into position on the stabilizer. Guide the joiner wire and hinges into position.

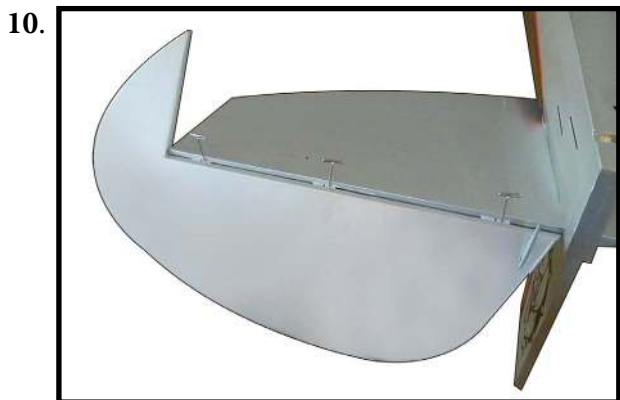

Fit the elevator so the leading edge fits tightly against the trailing edge of the stabilizer.



Check the fit of both elevators at this time. Once checked, remove the elevators.



Fit the elevators back into position. Remove the T-pins and slide the elevators tightly against the stabilizer. Use a paper towel and isopropyl alcohol to remove any excess epoxy before it begins to cure.

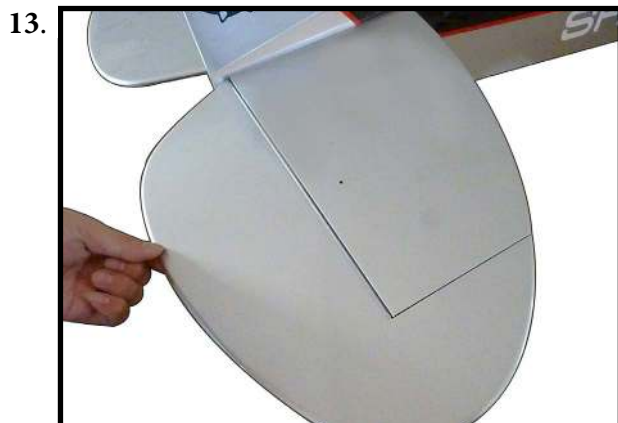

Flex the elevator slightly, making sure to keep the gap between the elevator and stabilizer as narrow as possible. Saturate each of the hinges using thin CA. Apply CA to the top of the hinges.

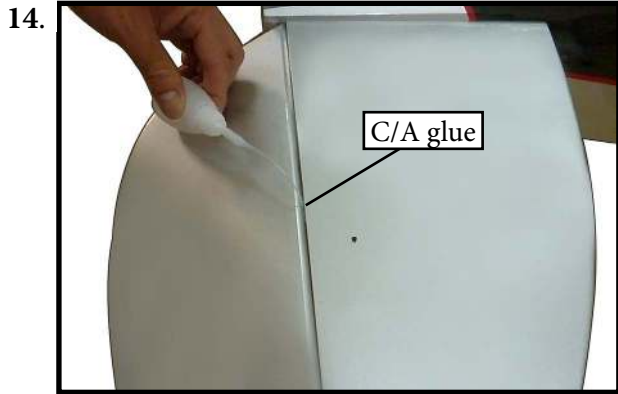

Gently pull on the fixed and moving surface to make sure the hinges are glued securely. If not, reapply thin CA to any hinges that are found loose.

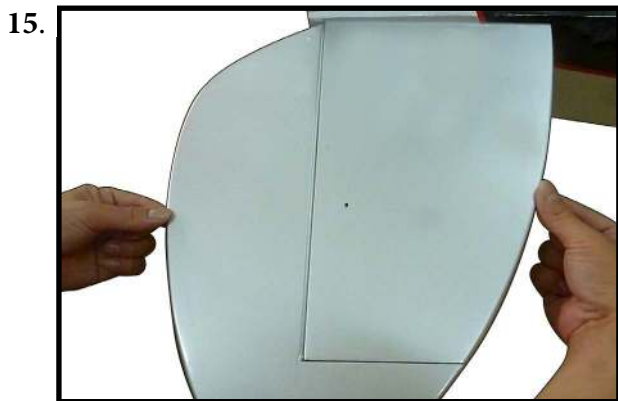

Flex the control surface through its range of motion a few 28. times to break-in the hinges. This will reduce the initial load on the servo when the surface is first actuated.

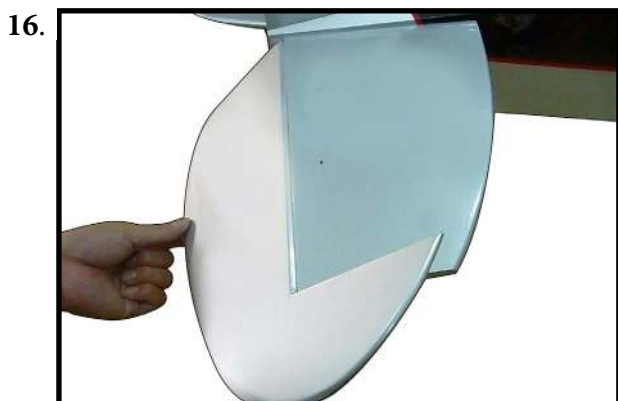

INSTALL RUDDER CONTROL HORN

Repeat steps to install the rudder control horn as same as steps done for ailerons.

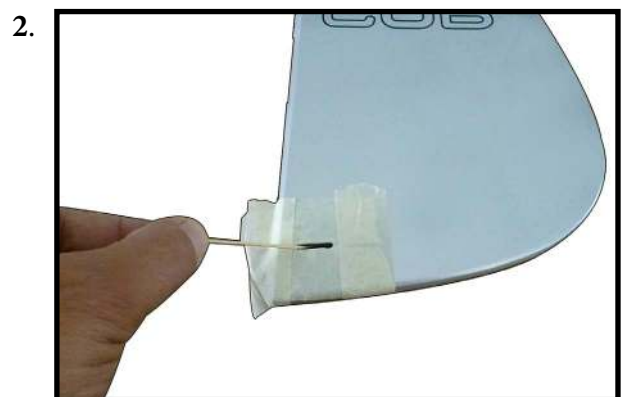
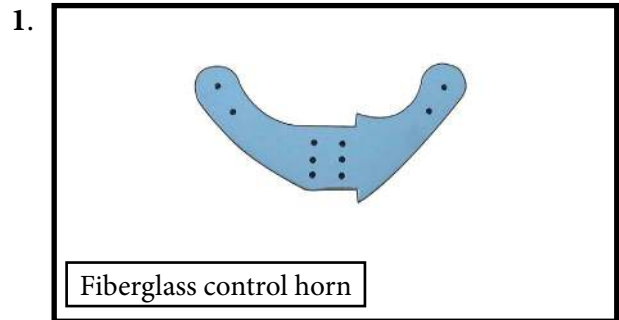

INSTALLING VERTICAL STABILIZER



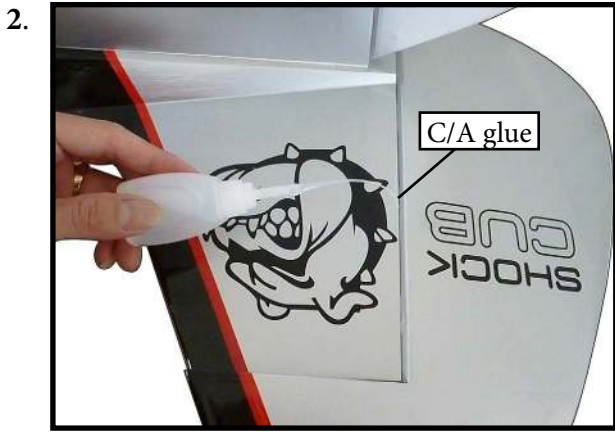

Thread one clevis and M2 lock nut on to each elevator control rod. Thread the horns on until they are flush with the ends of the control rods.

Elevator and rudder pushrods assembly as pictures below.

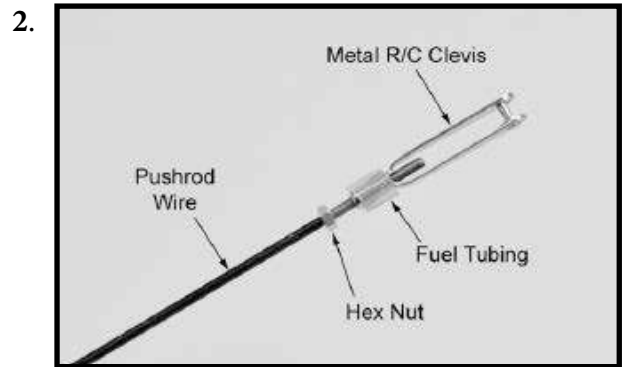

Locate items necessary to install rudder pushrod.

ELEVATOR PUSHROD INSTALLATION

Install the elevator control horn using the same method as with the aileron control horns.

Position the elevator control horn on the both side of elevator.

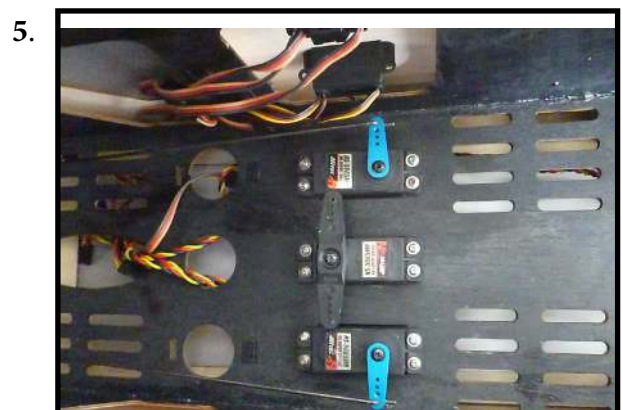
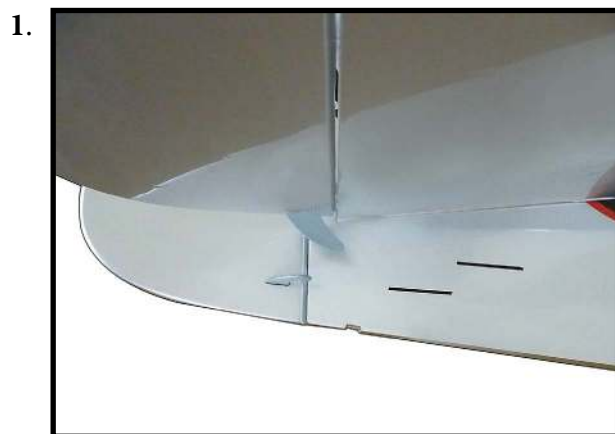
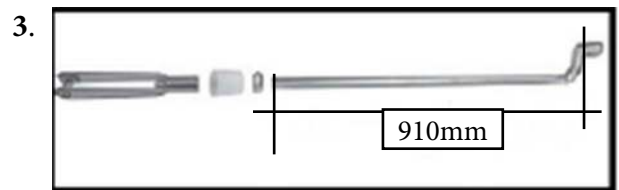

**RUDDER PUSHROD
INSTALLATION**

Repeat steps as same as steps done for elevator.

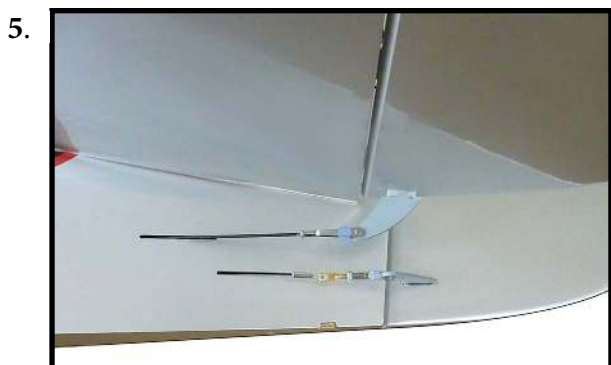
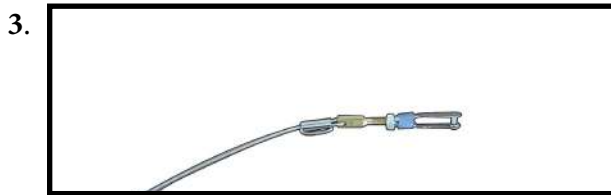

MOUNTING THE TAIL WHEEL

Locate items necessary to install tail wheel.

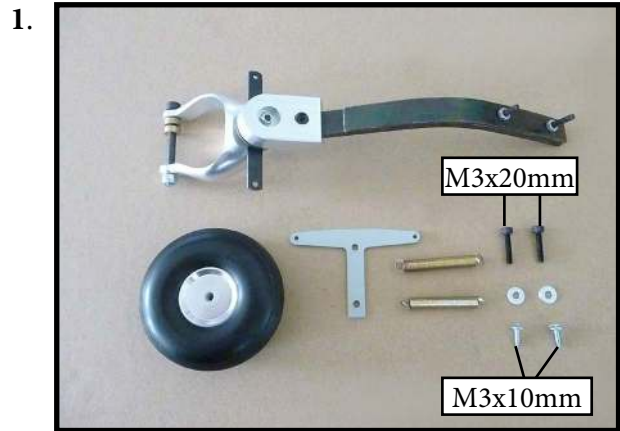

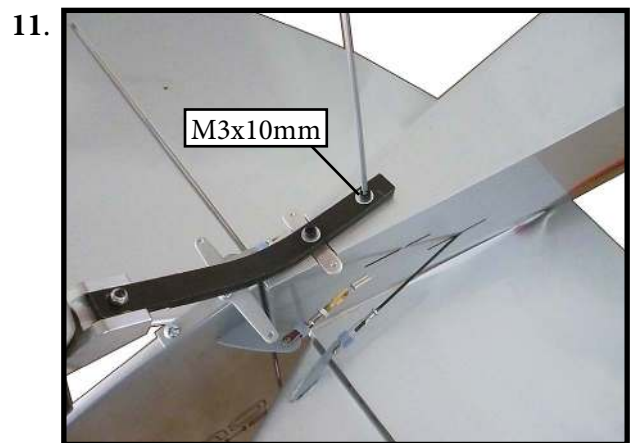
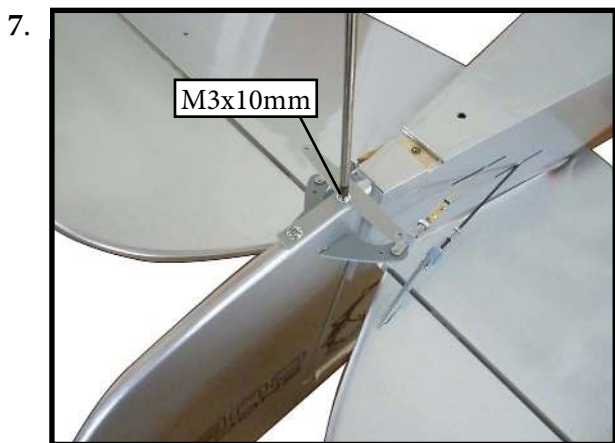
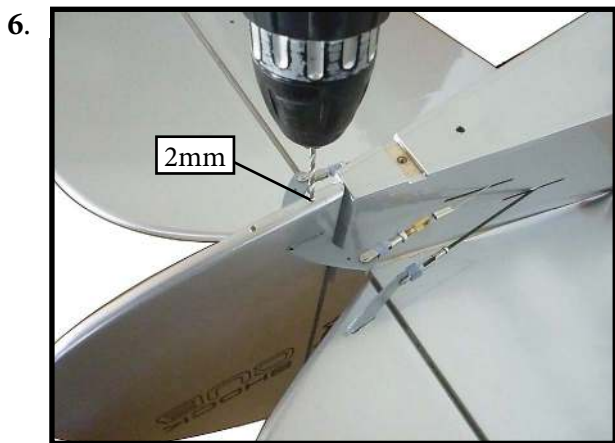



INSTALL BRACING WIRE AND METAL BRACKET AT THE TAIL

TOP VIEW.

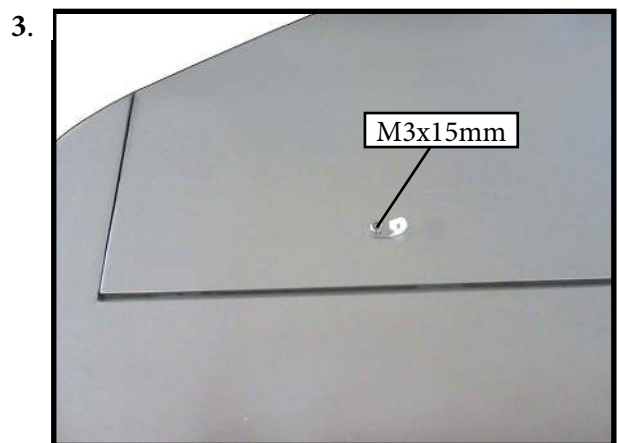
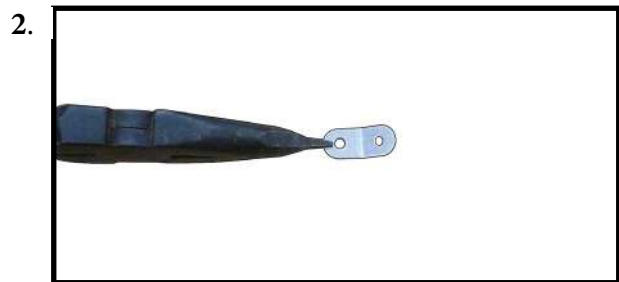
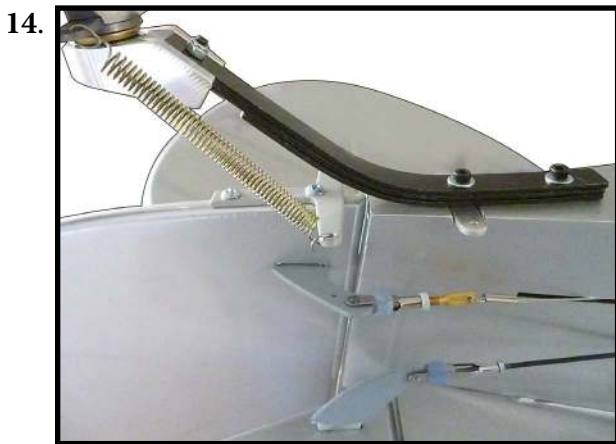

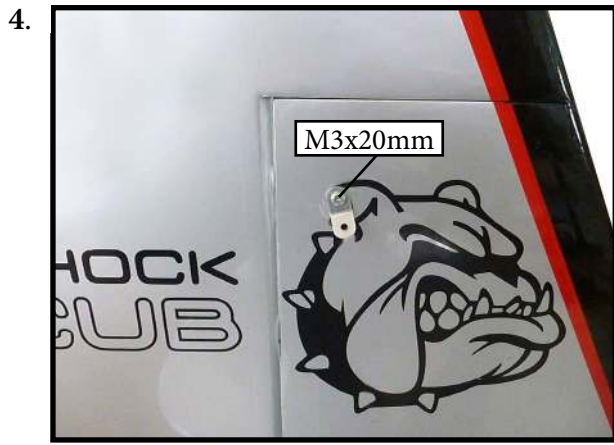

BOTTOM VIEW.

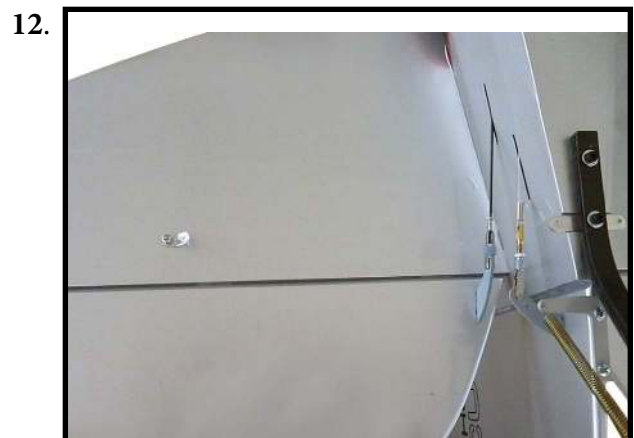
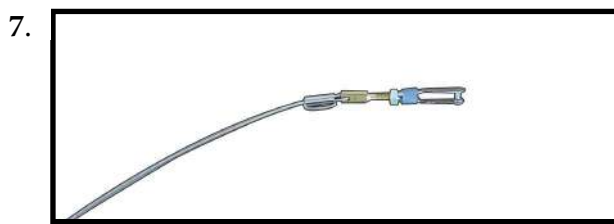
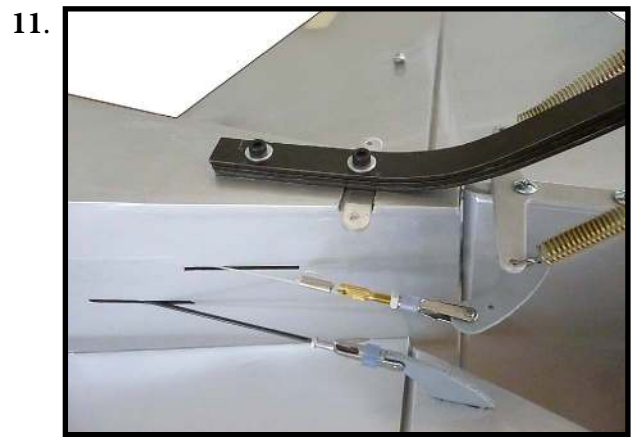

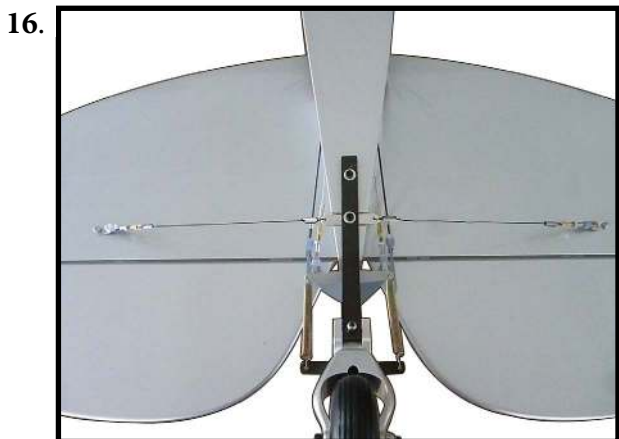
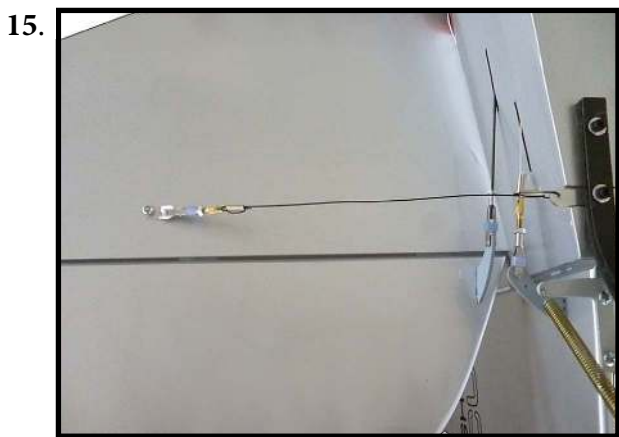
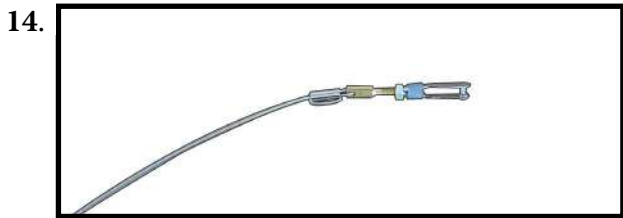

INSTALLING BATTERY - RECEIVER

Plug the servos leads and the switch lead into the receiver. Plug the battery pack lead into the switch also.

Wrap the receiver and battery pack in the protective foam rubber to protect them from vibration.

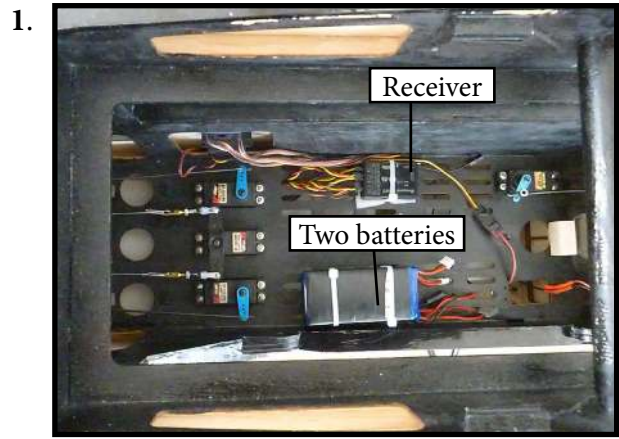

INSTALL THE WINDOW

Parts requirement. See pictures below.

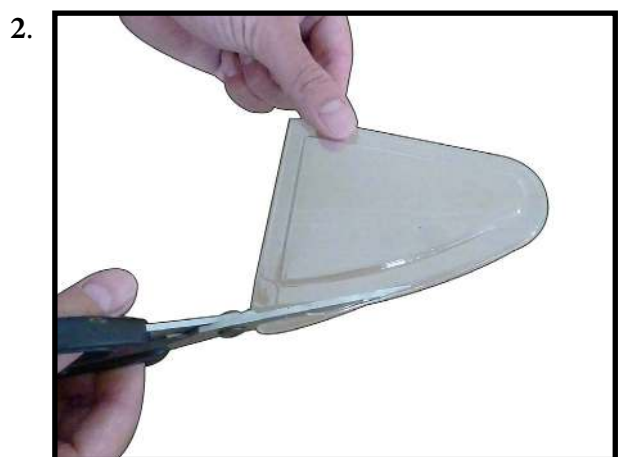
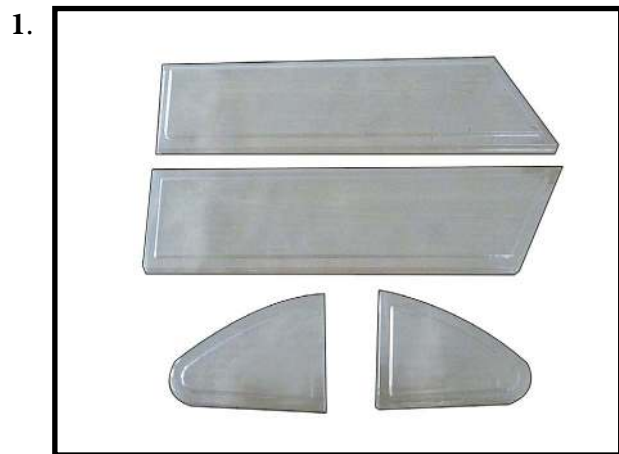

3.



7.

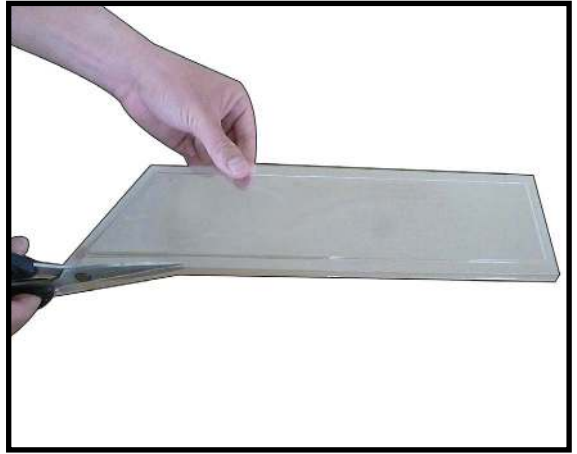

4.

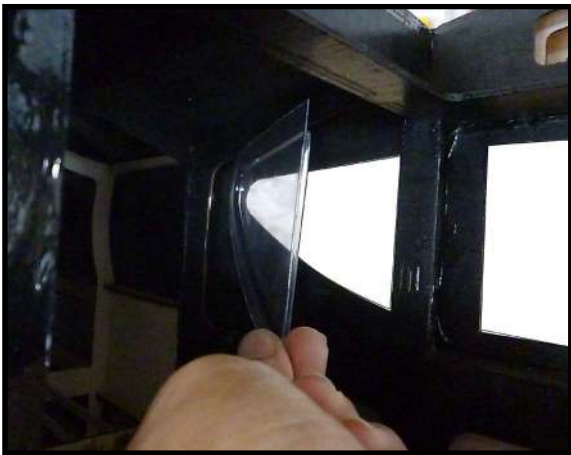

8.

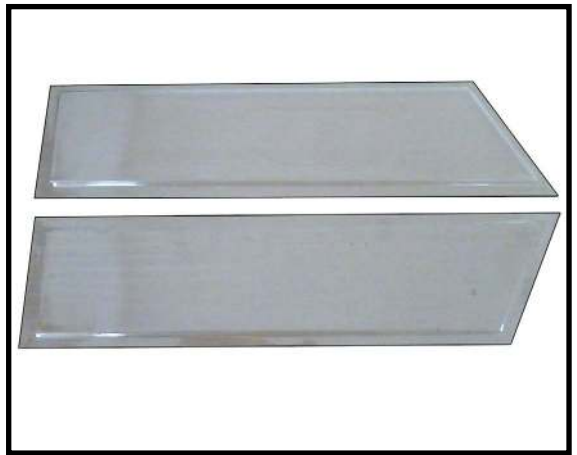

5.

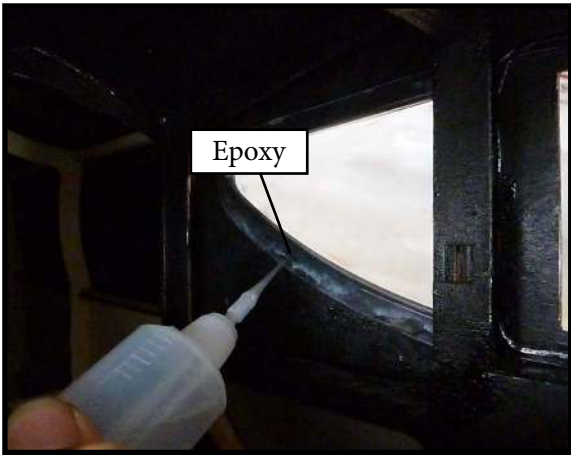

9.



6.



10.

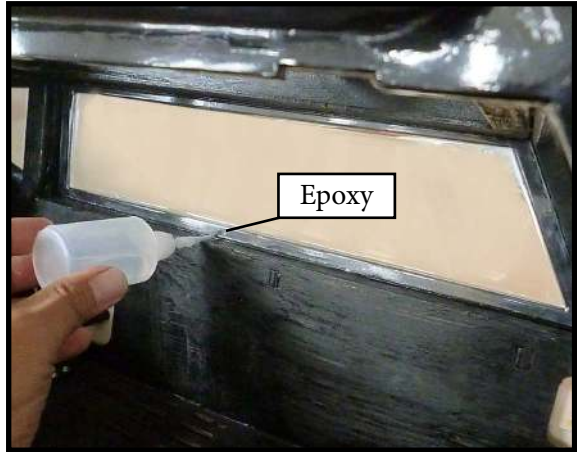

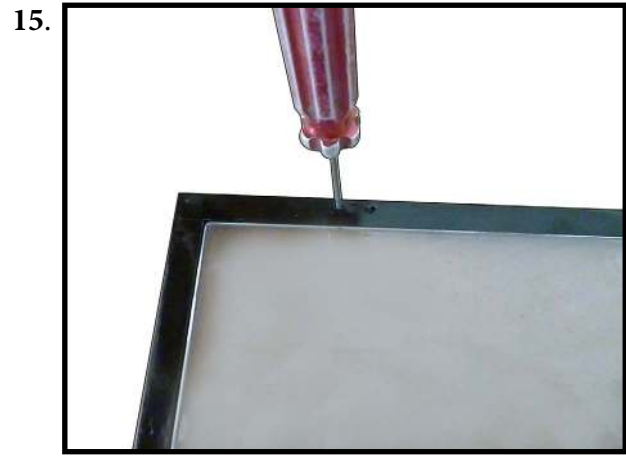

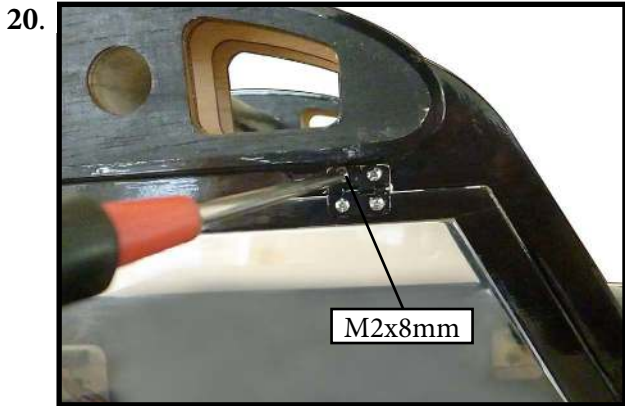
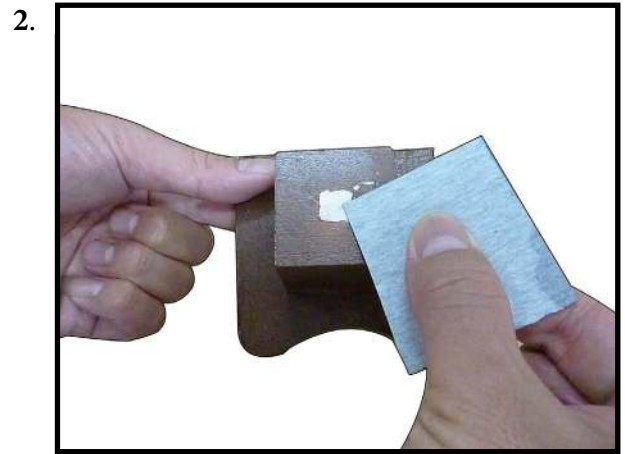

INSTALLATION CANOPY AND CHAIR

Locate items necessary to install canopy and chair.



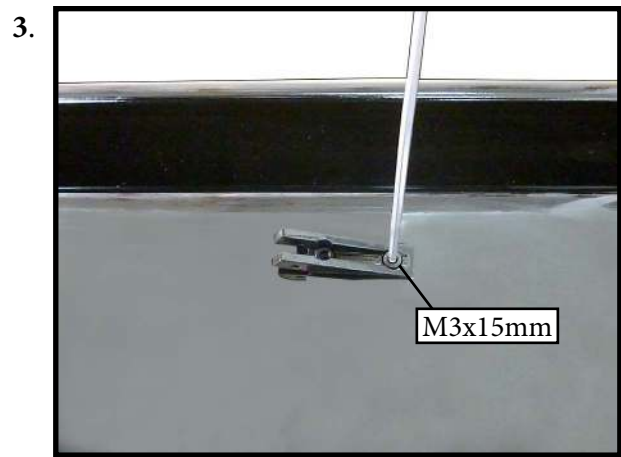

INSTALLATION WING STRUTS

Locate the items for this section of the manual.

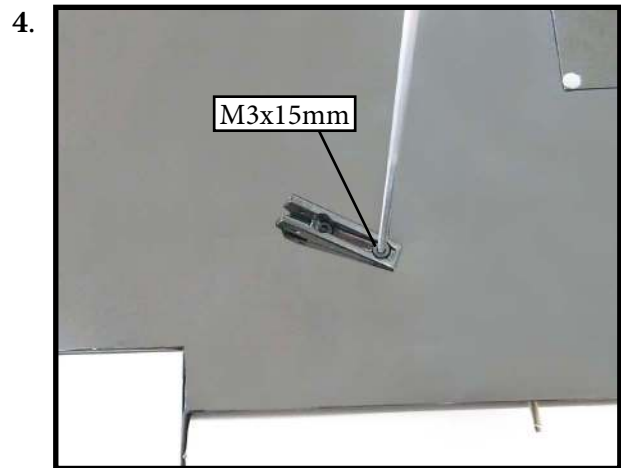

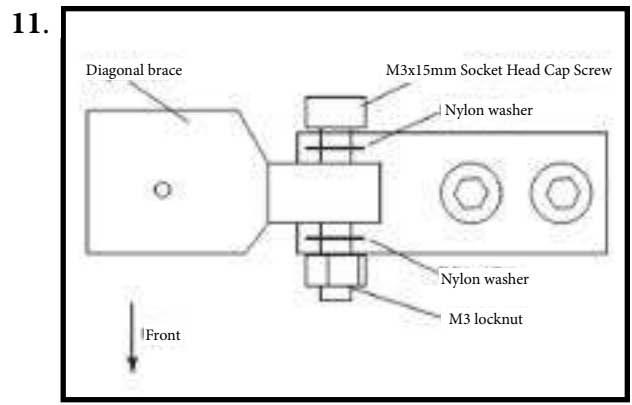
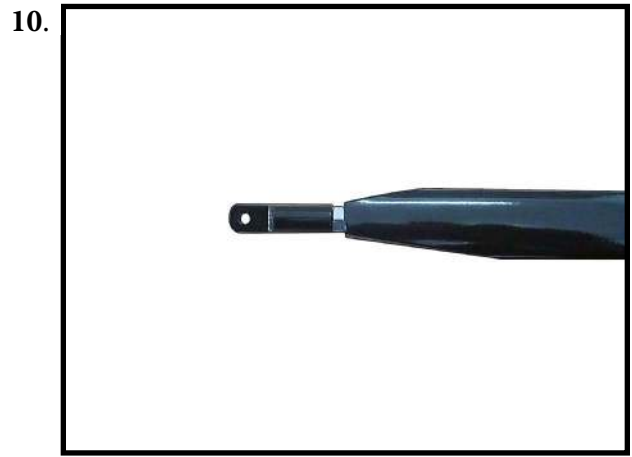
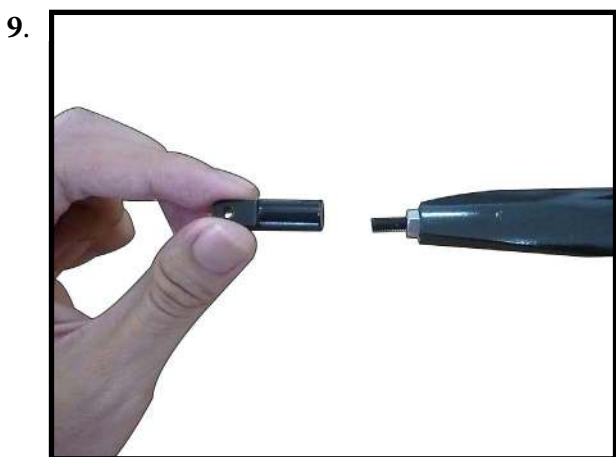
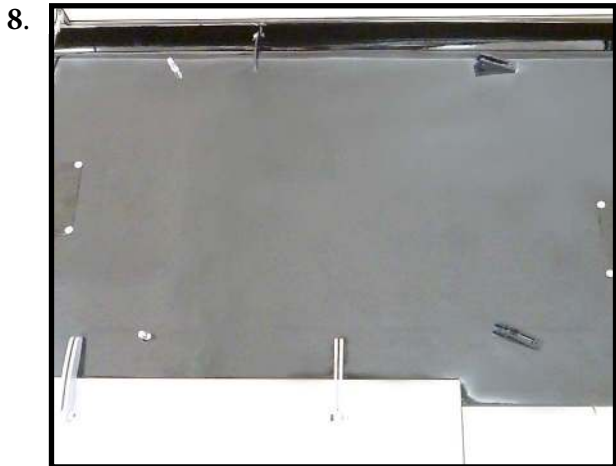

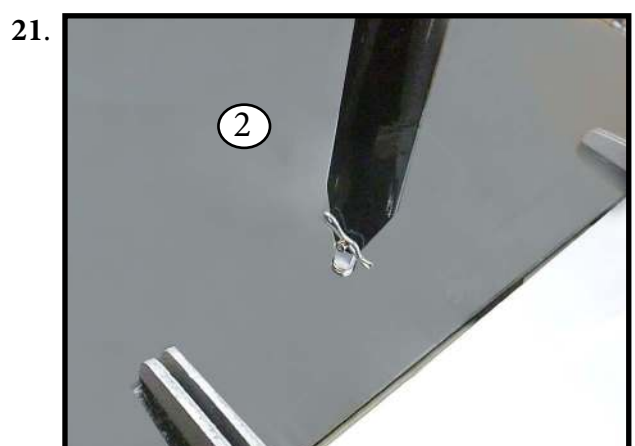
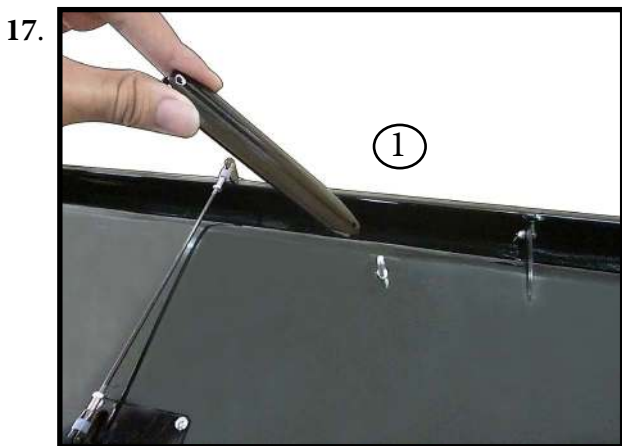
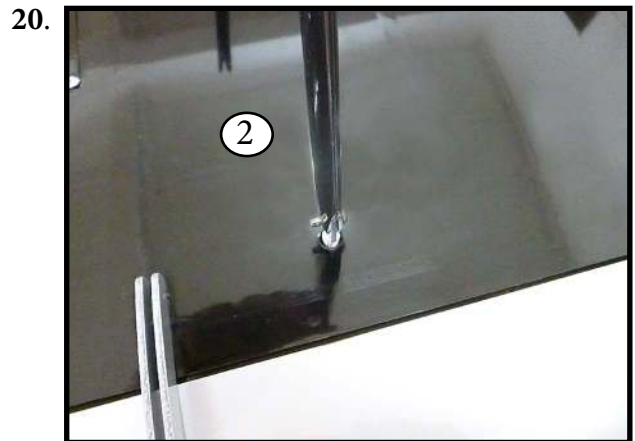
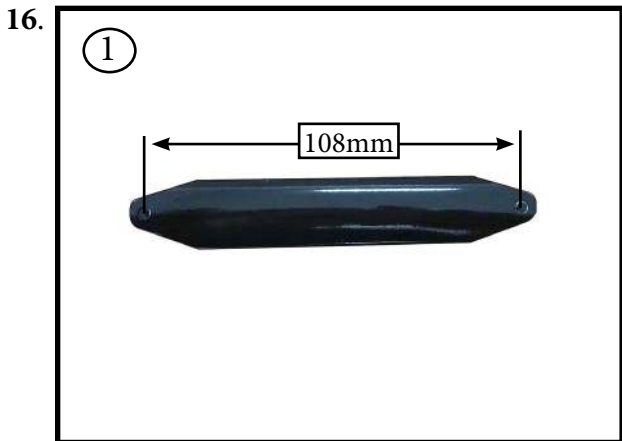
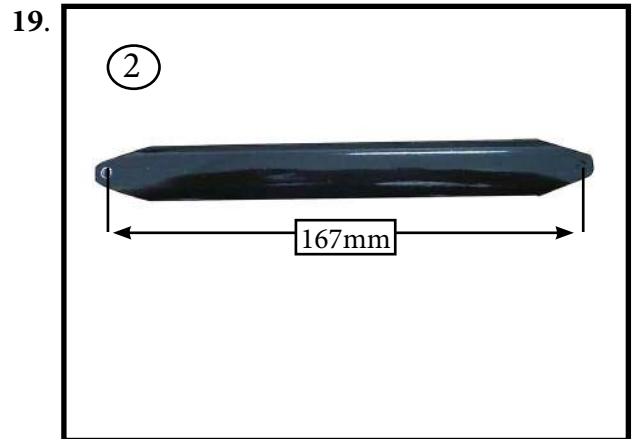
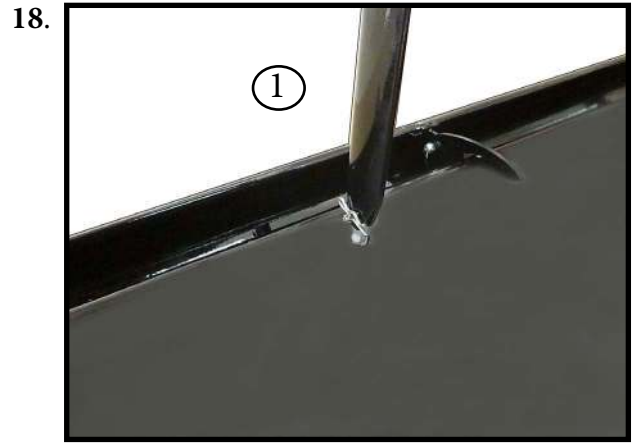

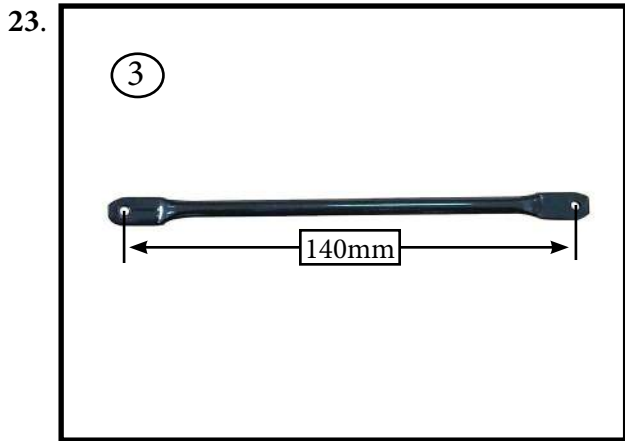
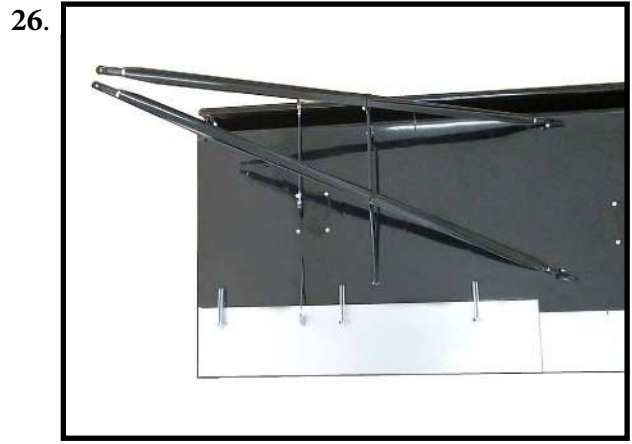
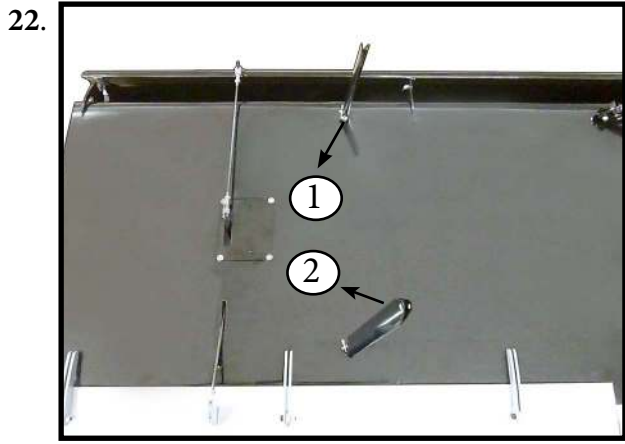

INSTALL WING TIP

Locate items necessary to install.

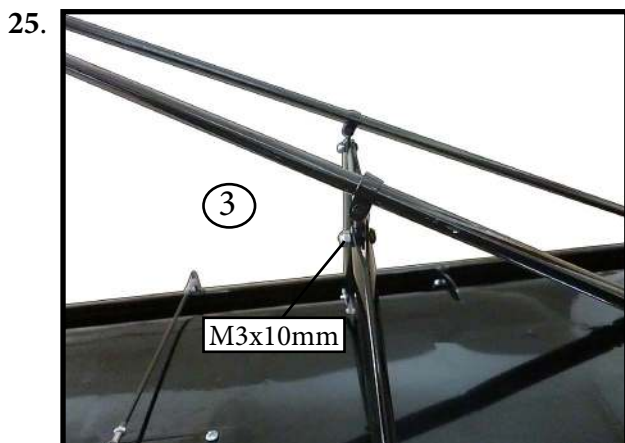
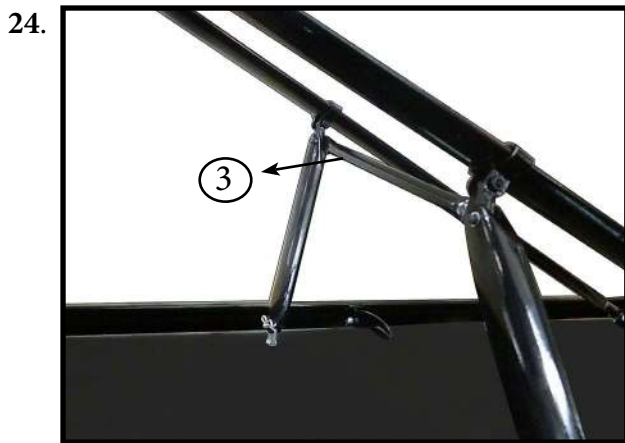

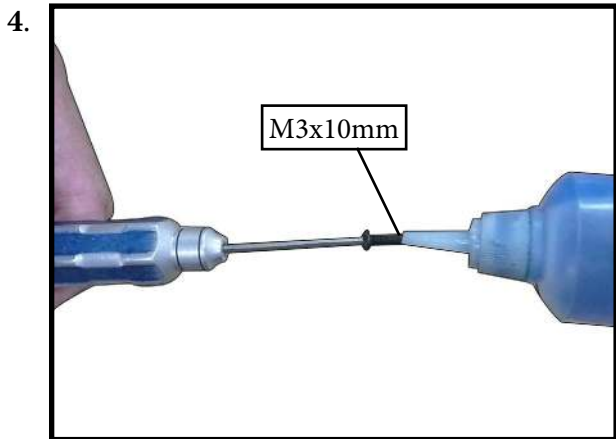

ATTACHMENT WING- FUSELAGE.

Attach the aluminium tube into fuselage.

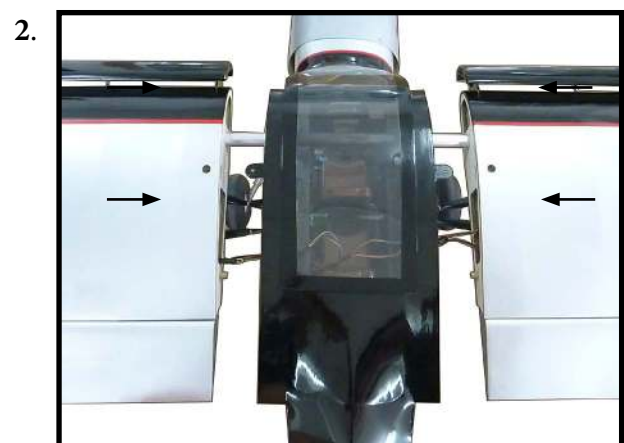
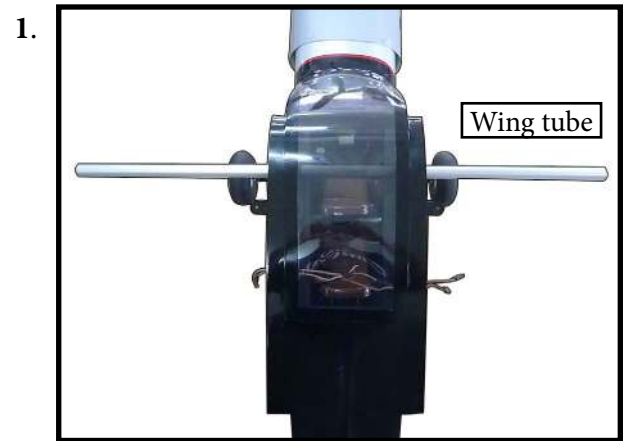

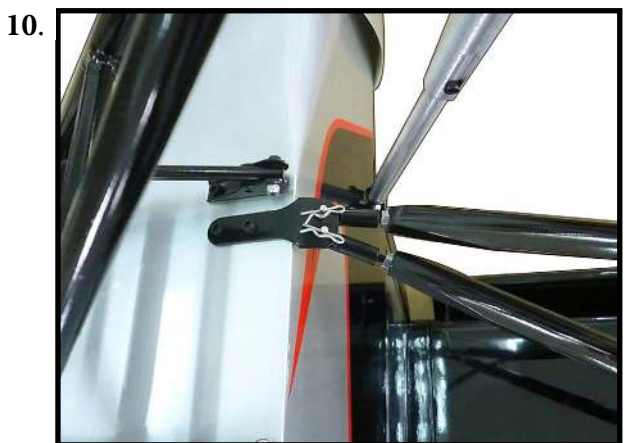
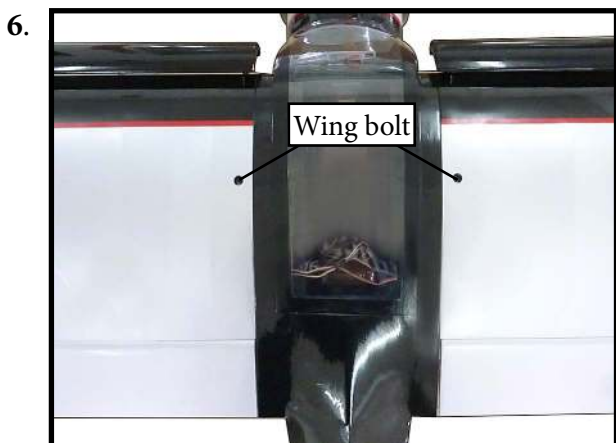
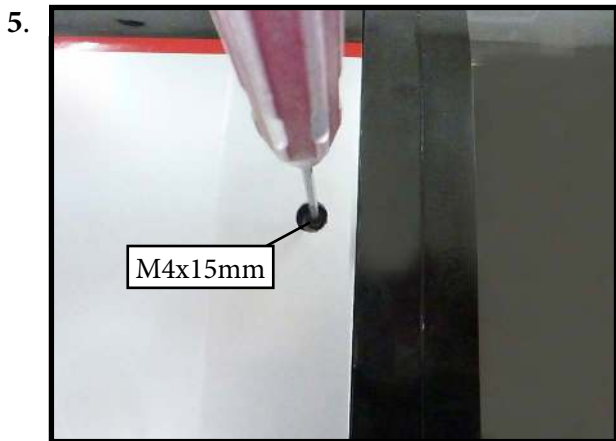
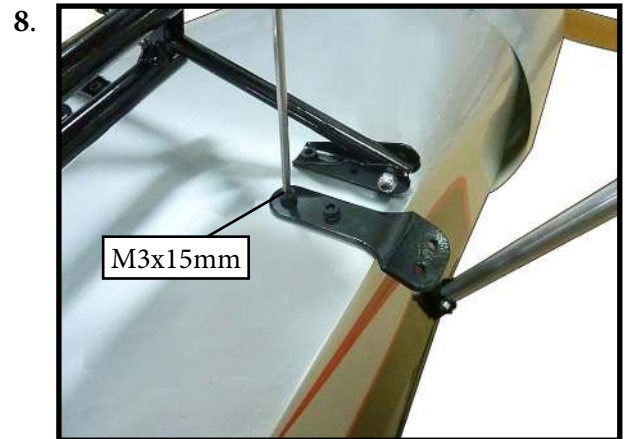
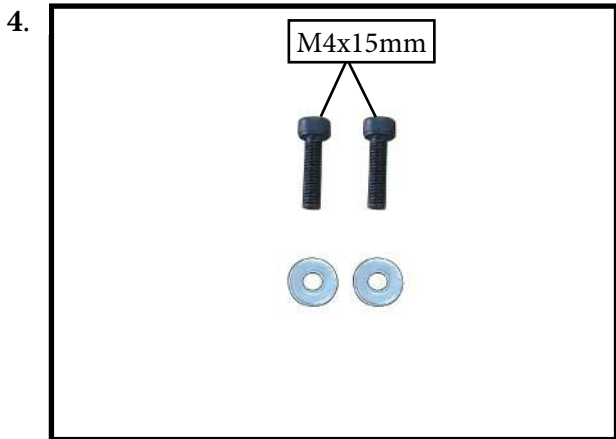

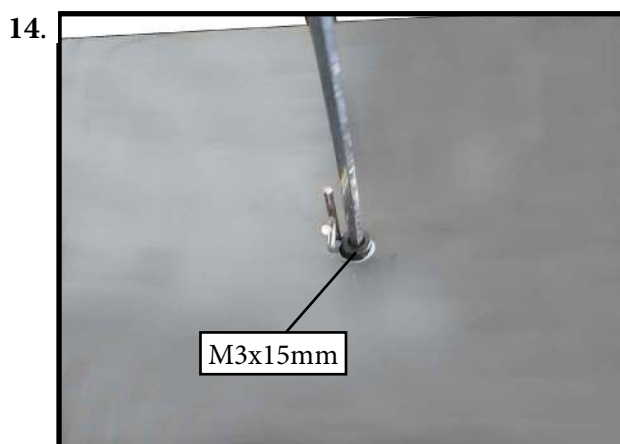
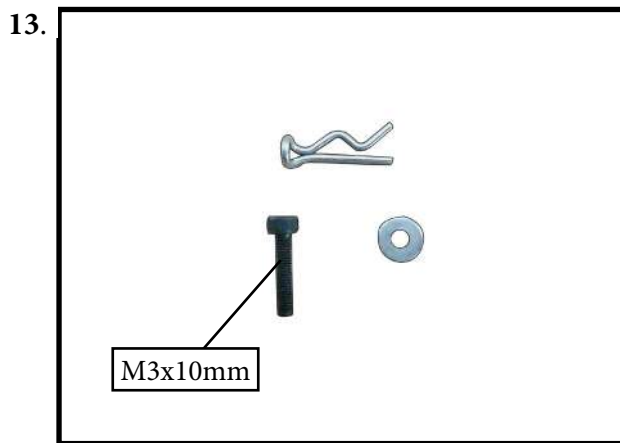
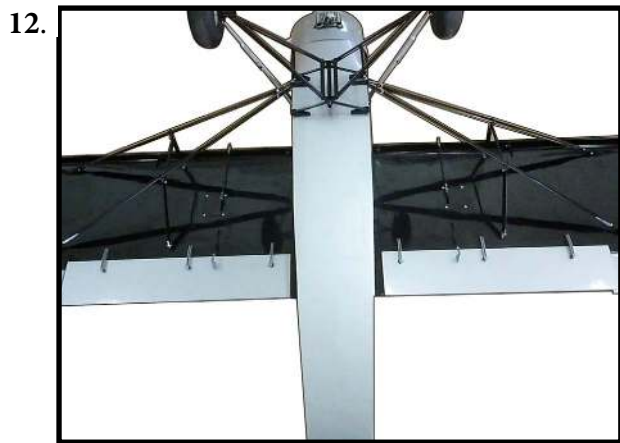

APPLY THE DECALS

1) If all the decals are precut and ready to stick. Please be certain the model is clean and free from oily fingerprints and dust. Position decal on the model where desired, using the photos on the box and aid in their location.

2) If all the decals are not precut, please use scissors or a sharp hobby knife to cut the decals from the sheet. Please be certain the model is clean and free from oily fingerprints and dust. Position decal on the model where desired, using the photos on the box and aid in their location.

BALANCING

An important part of preparing the aircraft for flight is properly balancing the model.

1) Attach the wing panels to the fuselage. Make sure to connect the leads from the aileron to the appropriate leads from the receiver. Make sure the leads are not exposed outside the fuselage before tightening the wing bolts. Your model should be flight-ready before balancing.

2) The recommended Center of Gravity (CG) location for your model is (120mm) back from the leading edge at the center of the wing.

3) When balancing your model, make sure it is assembled and ready for flight. Support the plane upright at the marks made on the wing with your fingers or a commercially available balancing stand. This is the correct balance point for your model.

*If possible, first attempt to balance the model by changing the position of the receiver battery and receiver. If you are unable to obtain good balance by doing so, then it will be necessary to add weight to the nose or tail to achieve the proper balance point.

With the wing attached to the fuselage, all parts of the model installed (ready to fly), and empty fuel tanks, hold the model at the marked balance point with the stabilizer level.

Lift the model. If the tail drops when you lift, the model is “tail heavy” and you must add weight* to the nose. If the nose drops, it is “nose heavy” and you must add weight* to the tail to balance.

1.

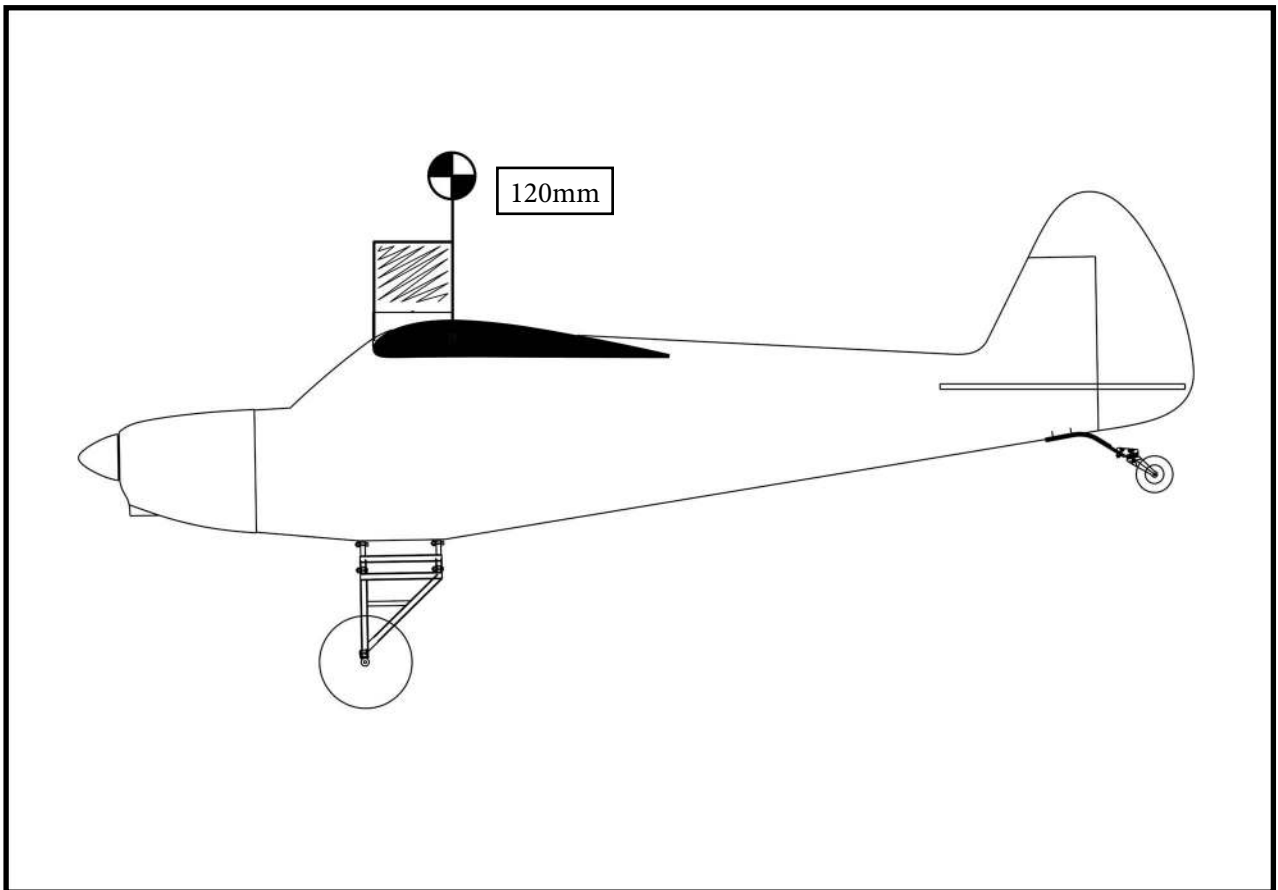

CONTROL THROWS

Ailerons:

High Rate :

Up : 70 mm

Down : 70 mm

Low Rate :

Up : 40 mm

Down : 40 mm

Rudder:

High Rate :

Right : 100 mm

Left : 100 mm

Low Rate :

Right : 60 mm

Left : 60 mm

Elevator:

High Rate :

Up : 80 mm

Down : 80 mm

Low Rate :

Up : 40 mm

Down : 40 mm

Flap:

Mid : 30 mm

Full : 80 mm

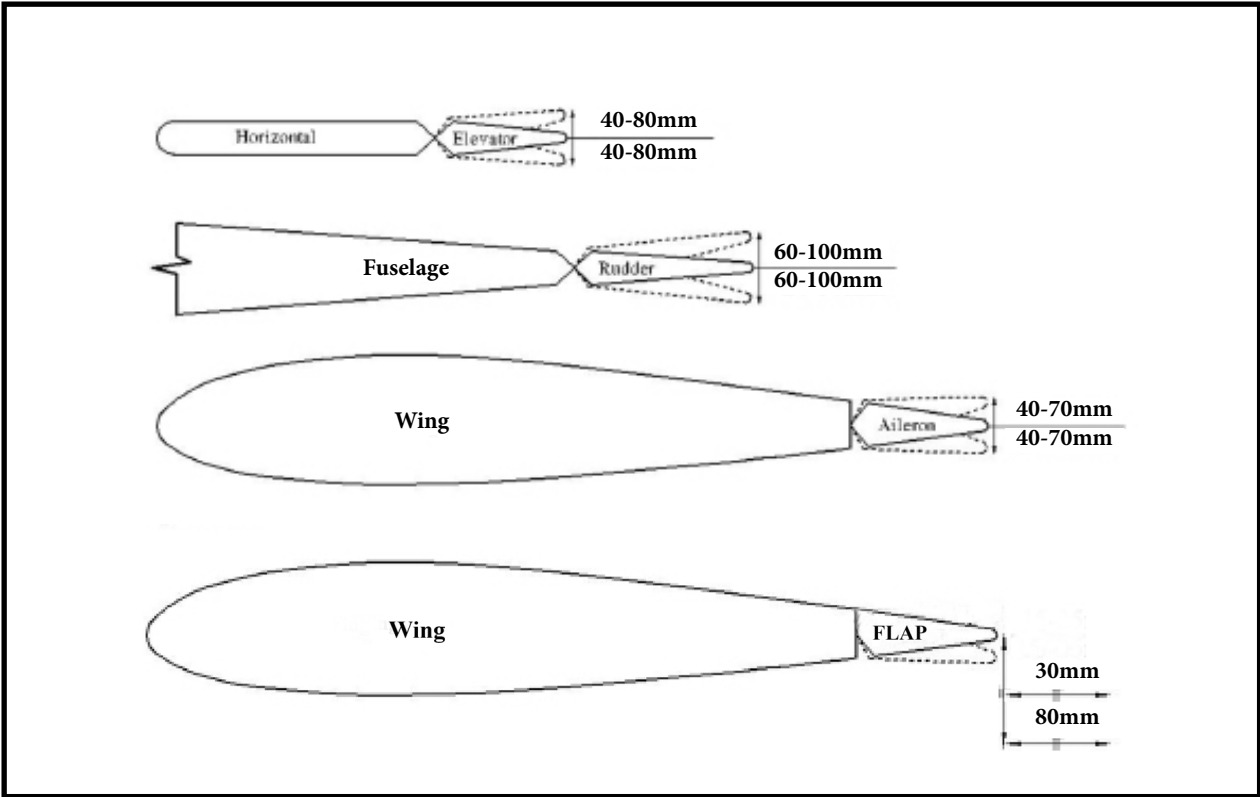

FLIGHT PREPARATION

Check the operation and direction of the elevator, rudder, ailerons and throttle.

□ A) Plug in your radio system per the manufacturer's instructions and turn everything on.

□ B) Check the elevator first. Pull back on the elevator stick. The elevator halves should move up. If they do not, flip the servo reversing switch on your transmitter to change the direction.

□ C) Check the rudder. Looking from behind the airplane, move the rudder stick to the right. The rudder should move to the right. If it does not, flip the servo reversing switch on your transmitter to change the direction.

□ D) Check the throttle. Moving the throttle stick forward should open the carburetor barrel. If it does not, flip the servo reversing switch on your transmitter to change the direction.

□ E) From behind the airplane, look at the aileron on the right wing half. Move the aileron stick to the right. The right aileron should move up and the other aileron should move down. If it does not, flip the servo reversing switch on your transmitter to change the direction.

PREFLIGHT CHECK

□ 1) Completely charge your transmitter and receiver batteries before your first day of flying.

□ 2) Check every bolt and every glue joint in the SHOCK CUB 35-55cc to ensure that everything is tight and well bonded.

□ 3) Double check the balance of the airplane. Do this with the fuel tank empty.

□ 4) Check the control surfaces. All should move in the correct direction and not bind in any way.

□ 5) If your radio transmitter is equipped with dual rate switches double check that they are on the low rate setting for your first few flights.

□ 6) Check to ensure the control surfaces are moving the proper amount for both low and high rate settings.

□ 7) Check the receiver antenna. It should be fully extended and not coiled up inside the fuselage.

□ 8) Properly balance the propeller. An out of balance propeller will cause excessive vibration which could lead to engine and/or airframe failure.

*We wish you many safe and enjoyable flights
with your SHOCK CUB 35-55cc.*

*If you have any queries, or are interested in our products,
please feel free to contact us*

Factory : 12/101A - Hamlet 4 - Le Van Khuong Street - Dong Thanh Ward -
Hoc Mon District - Ho Chi Minh City - Viet Nam.

Office : 62/8 Ngo Tat To Street - Ward 19 - Binh Thanh District - Ho Chi Minh
City - Viet Nam

Phone : 848 - 86622289 or 848- 36018777

Website : www.SeagullModels.com

Email : Sales@seagullmodels.com

Facebook : www.facebook.com/SeaGullModels.