

# ASSEMBLY MANUAL



"Graphics and specifications may change without notice"

## Specifications:

- 1/6 Scale.
- Wing Span: 82.5" GIANT SCALE.
- Wing Area approx 1086 square inches.
- Length: 62".
- Flying Weight: Approx 20-23 lbs.
- Radio: 6-12+ channels with 9+ Servos .
- Depending on your custom/preferred set up.  
(Throttle, Choke if using Gas/Glow Engine, 2-Elevator, 1-2 Rudder/Nose Steering, 2-Ailerons, 2-Flaps, 1 Speed Brake, 1 Landing Gear if Pneumatic, 2-3 Mini Servos For Gear Doors)
- Recommended Gas Engine: Stinger 40cc Twin with Scale T-28 Custom Mufflers or Electric Equivalent.
- Note: Customer may choose to use other 35cc-50cc Gas Engines but will need to shorten nose strut and move retract back to clear Engine Cylinder Head. We designed this model around the Stinger 40cc Twin Gas Engine or Electric Motors to preserve the scale gear stance and have Scale Functional Exhaust.
- Cowling Diameter Approx 9.25 Inches.
- Does not include: retractable landing gear, scale wheels, radio, engine/motor, mufflers, adhesives, pilot figures, or fuel line.

## INTRODUCTION

Thank you for choosing the **LEGEND HOBBY 1/6 Giant Scale North American T-28 82.5" ARF 35-60cc** manufactured by **SG MODELS**. The **1/6 Giant Scale North American T-28 82.5" ARF 35-60cc** was designed with the intermediate/advanced sport flyer in mind. It is a semi scale airplane which is easy to fly and quick to assemble. The airframe is conventionally built using balsa, plywood to make it stronger than the average ARTF, yet the design allows the aeroplane to be kept light for its size. You will find that most of the work has been done for you already. The control surfaces have been pre-fitted with hinges are ready to be final glued into place. Flying the **LEGEND HOBBY 1/6 Giant Scale North American T-28 82.5" ARF 35-60cc** is simply a joy.

This instruction manual is designed to help you build a great flying aircraft. Please read this manual throughly a few time before starting assembly of your **1/6 Giant Scale North American T-28 82.5" ARF 35-60cc**. Use the parts listing below to indentify all parts.

## WARNING !

***Please be aware that this model aircraft is not a toy and if assembled or used incorrectly it is capable of causing injury to people or property. WHEN YOU FLY THIS AIRCRAFT YOU ASSUME ALL RISK & REPONSIBILITY.***

If you are inexperienced with basic R/C flight we strongly recommend you contact your R/C supplier and join your local R/C model Flying Club. R/C Model Flying Clubs offer a variety of training procedures designed to help the new pilot follow a more enjoyable and successful path to R/C flight. They will also be able to advise on any insurance and safety regulations that may apply.

## LEGEND HOBBY 86" A-1 SKYRAIDER KIT CONTENTS

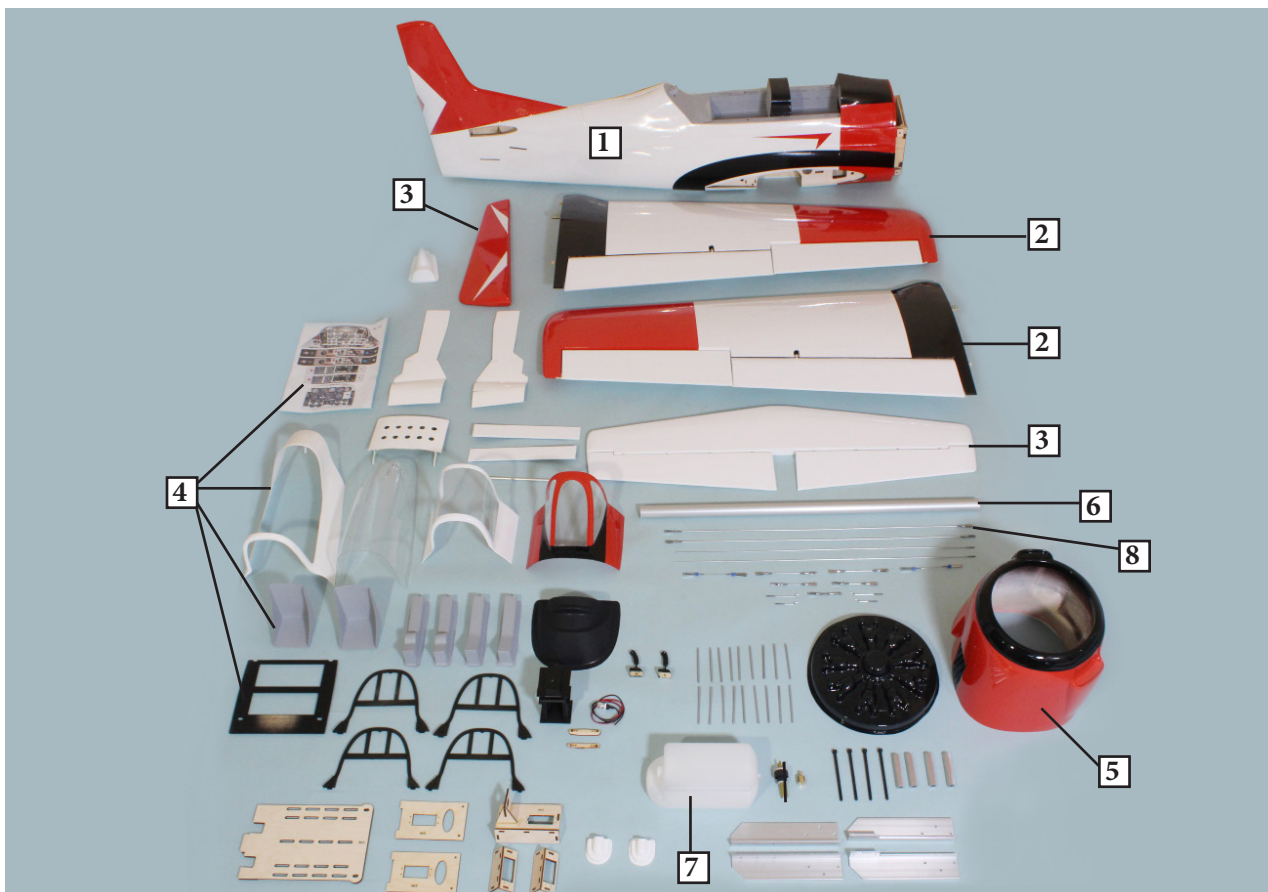



## KIT CONTENTS

### SEA365 1/6 Giant Scale North American T-28 82.5" ARF 35-60cc

1. Fuselage
2. Wing set (2pcs)
3. Tail set (2pcs)
4. Cockpit, Pilot and Canopy
5. Cowling
6. Wing tube
7. Fuel tank
8. Pushrod set

## ADDITIONAL ITEMS REQUIRED

- 35-60cc Engine or Electric Motor and ESC.
- Computer radio 6-12+ channel with 9+ servos.
- Spark plug to suit engine.
- Propeller to suit engine.
- Protective foam rubber for radio system.

## TOOLS & SUPPLIES NEEDED

- Thin cyanoacrylate glue.
- Medium cyanoacrylate glue.
- 30 minute epoxy.
- 5 minute epoxy.
- Hand or electric drill.
- Assorted drill bits.
- Modelling knife.
- Straight edge ruler.
- 2mm ball driver.
- Phillips head screwdriver.
- 220 grit sandpaper.
- 90° square or builder's triangle.
- Wire cutters.
- Masking tape & T-pins.
- Thread-lock.
- Paper towels.

## INSTALL THE AILERONS

Please see pictures below.

1.

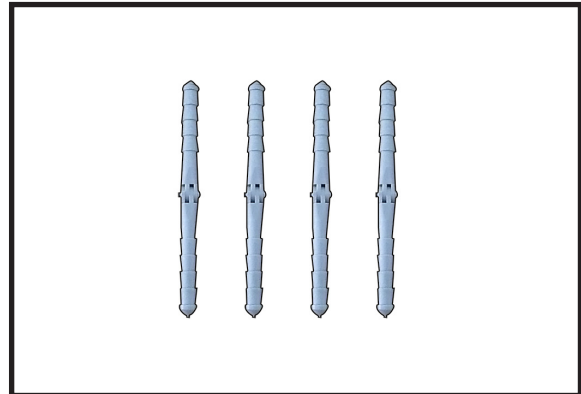

2.

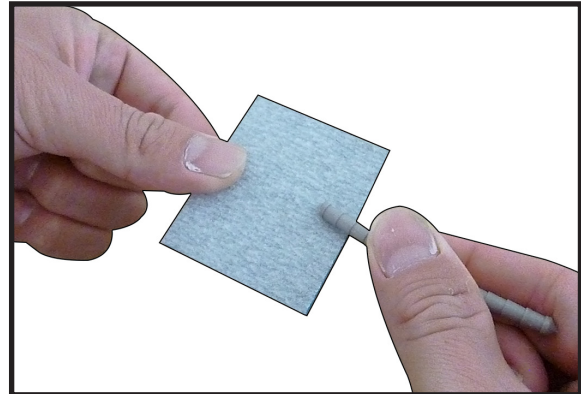

Remove the ailerons from the wing and remove the hinges.

Use a small piece of rough sandpaper to scuff the hinges for better epoxy adhesion. Do this to all aileron hinges.

3.

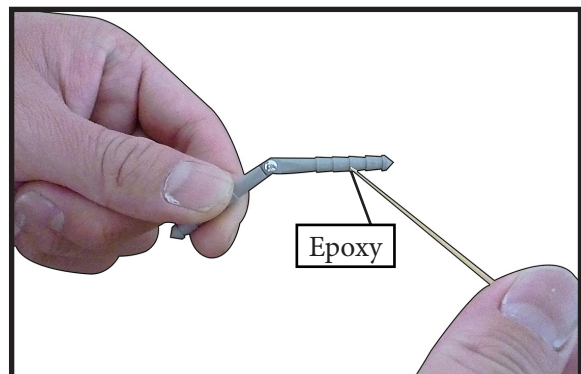

Apply epoxy to each hinge where it will be inserted into the ailerons. Tip: Apply some petroleum jelly to the metal pin hinge area to keep epoxy from interfering with smooth operation of hinge.

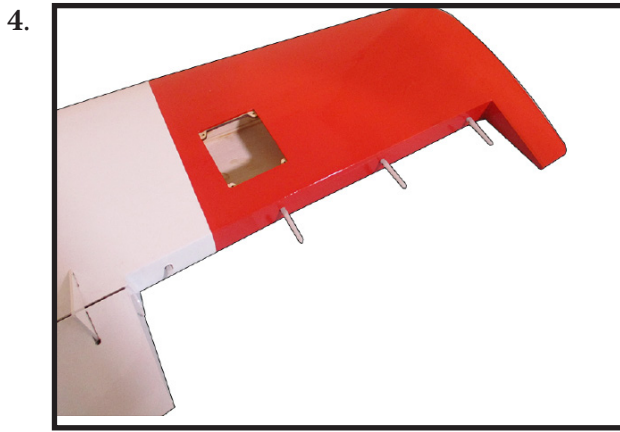

Insert all four hinges in the ailerons at this time. Make sure hinges move up and down in right direction and not side to side !

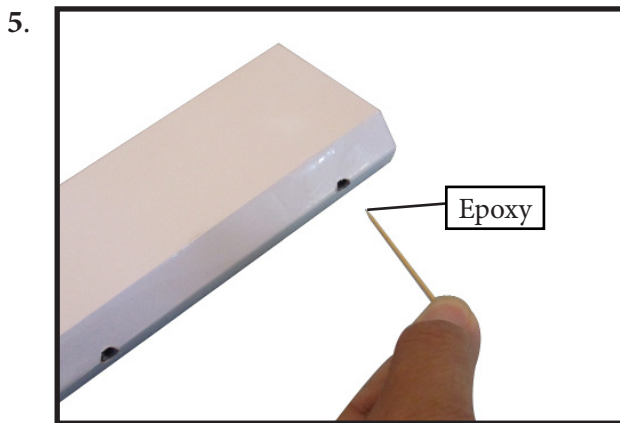

Apply epoxy into each of the holes in the ailerons using a spare piece of pushrod wire or toothpick.

Make sure to use enough epoxy so it securely adheres the hinge to the surfaces.

Do not use an excessive amount of epoxy when gluing the hinges so that it expels from the hinge area.

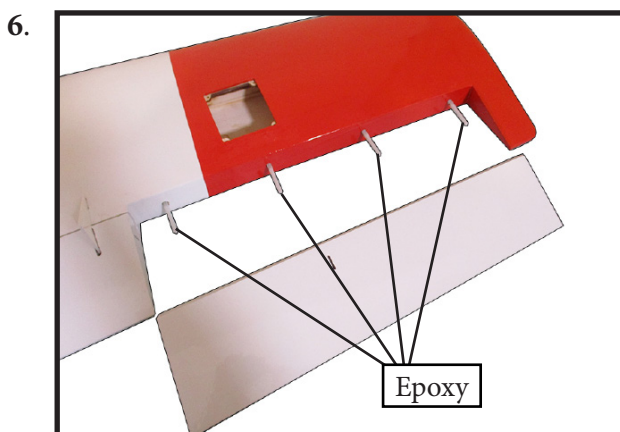

Be sure to test the aileron hinges once you insert them. Ensure that the hinge pockets line up, and that the hinges move freely before the epoxy dries.

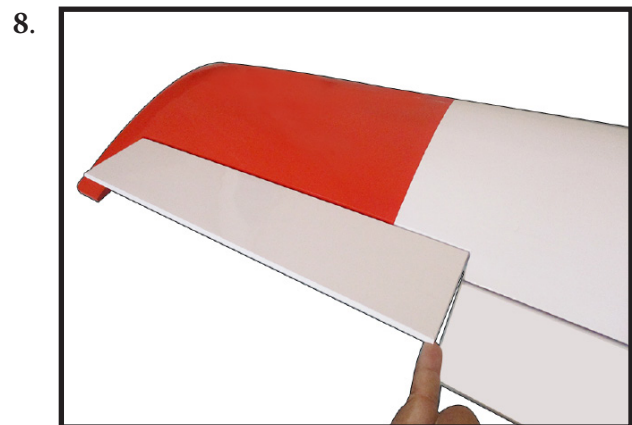
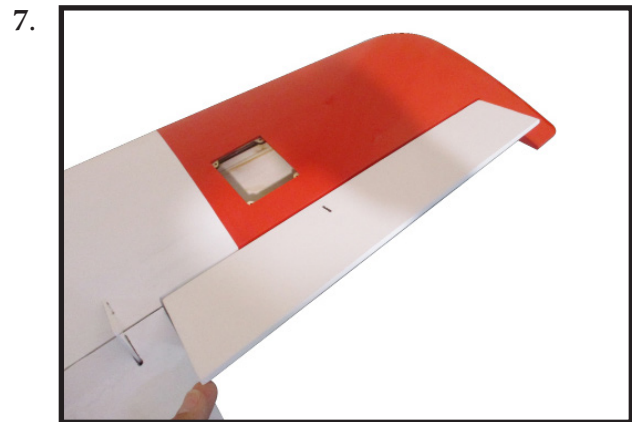

Check the fit of the aileron to the wing. The top of the ailerons will align to the top of the wing. Make sure movement is smooth and bind free.

We prefer 30-minute epoxy to allow enough working time during the hinge installation.

### INSTALL THE AILERONS CONTROL HORN

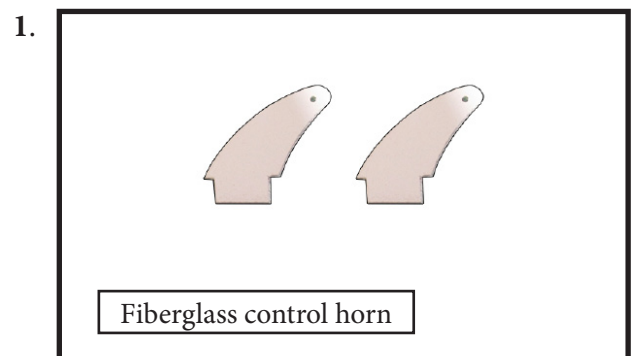



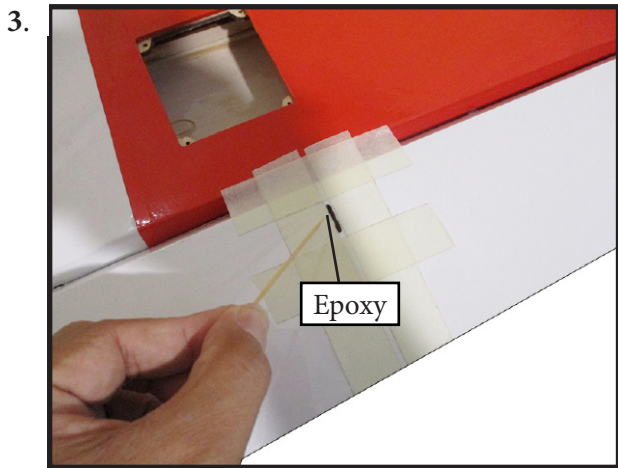
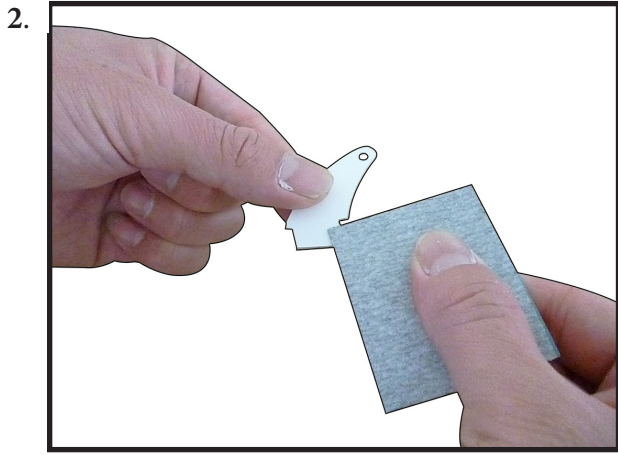

## INSTALLING THE AILERON SERVOS

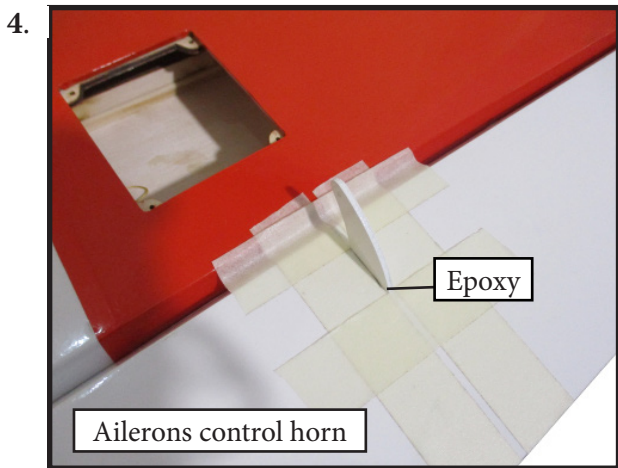
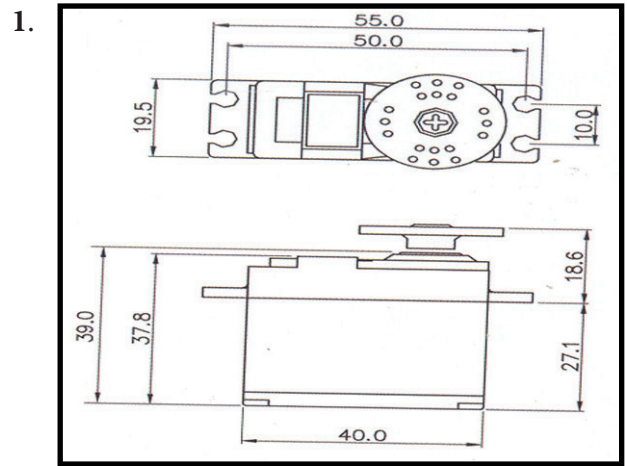

**Minimum servo spec.**  
**Torque :** 6.0V: 157.00 oz-in (11.31 kg-cm)  
 7.4V: 179.00 oz-in (12.89 kg-cm)

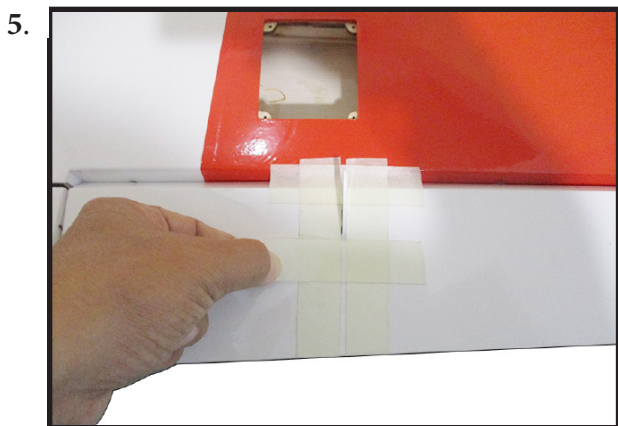

**!** Because the size of servos differ, you may need to adjust the size of the precut opening in the mount. The notch in the sides of the mount allow the servo lead to pass through.

Place the servo between the mounting blocks and space it from the hatch. Use a pencil to mark the mounting hole locations on the blocks.

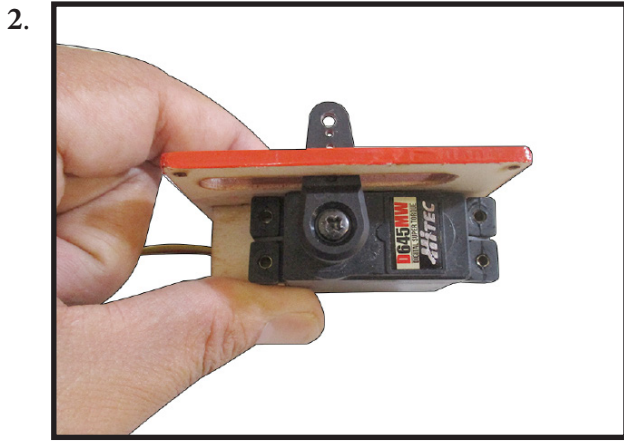

Use drill bit in a pin vise to drill the mounting holes in the blocks.

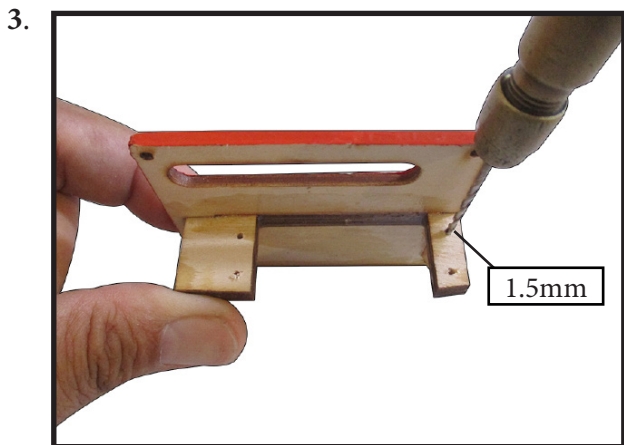

Apply 2-3 drops of thin C/A to each of the mounting holes. Allow the C/A to cure without using accelerator.

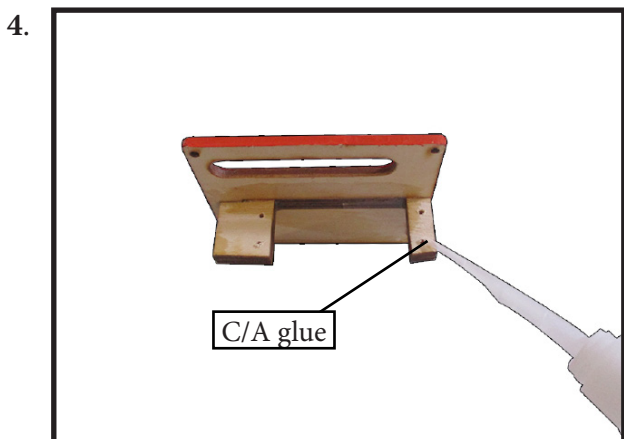

Use dental floss or heat shrink tubing to secure the connection between the servo and extension wire so they cannot become unplugged accidentally.

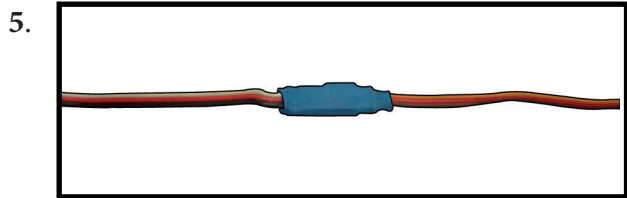

Secure the servo to the aileron hatch using a proper driver and the screws provided with the servo.

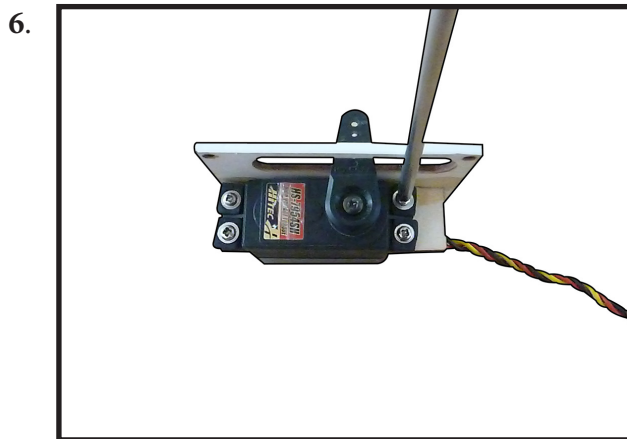

Apply 2-3 drops of thin C/A to each of the mounting aileron hatch mounting tabs in the wing. \*\*\* Allow the C/A to cure without using accelerator.\*\*\*

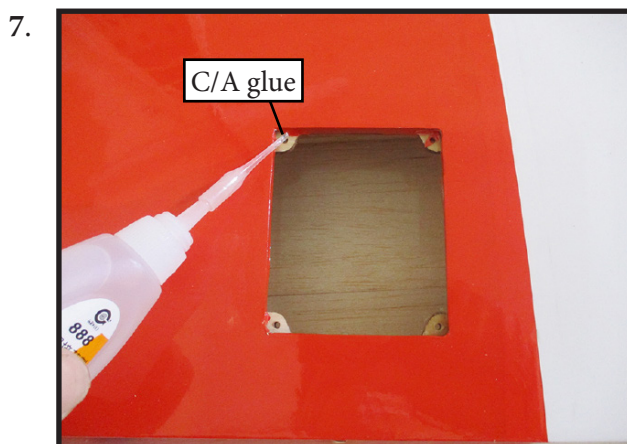

Remove the string from the wing at the servo location and use the tape to attach it to the servo extension lead. Pull the lead through the wing and remove the string.



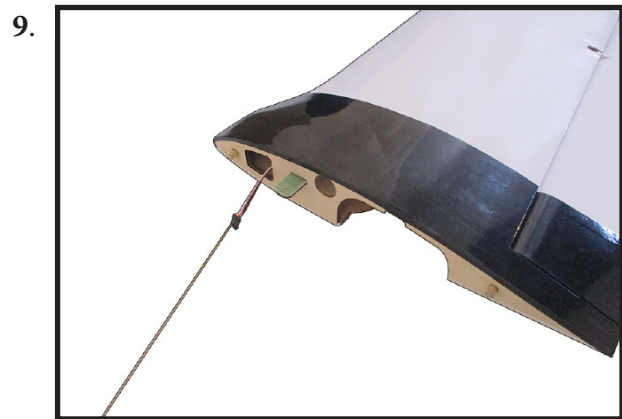
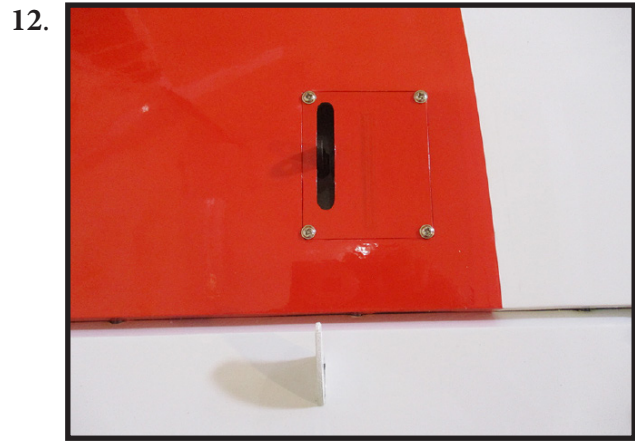
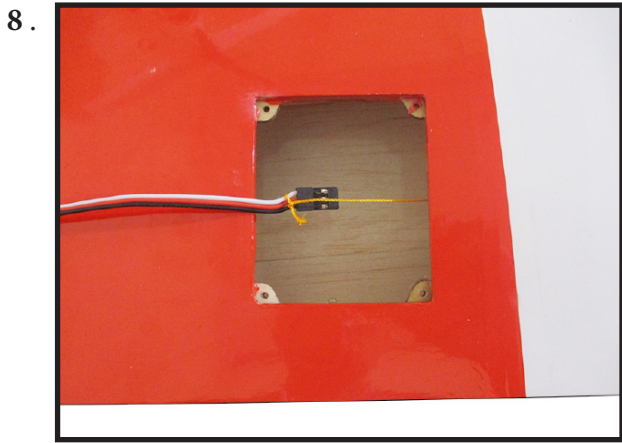

**AILERON PUSHROD INSTALLATION**

Please see pictures below.

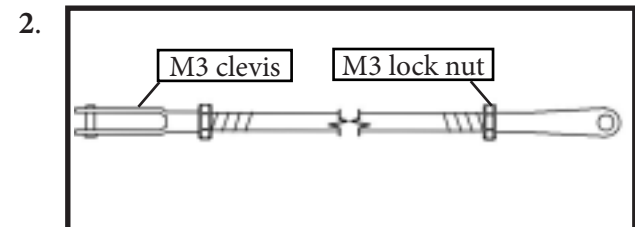
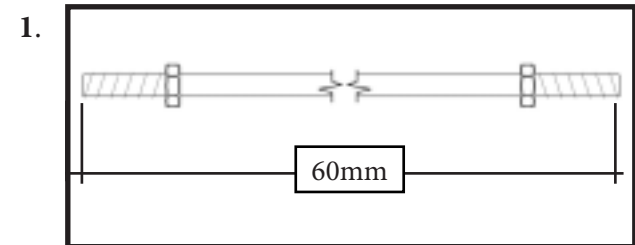
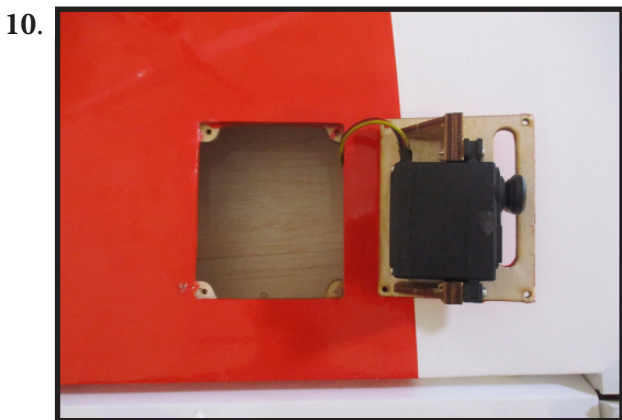

Set the aileron hatch in place and use a Phillips screw driver to install it with four wood screws.

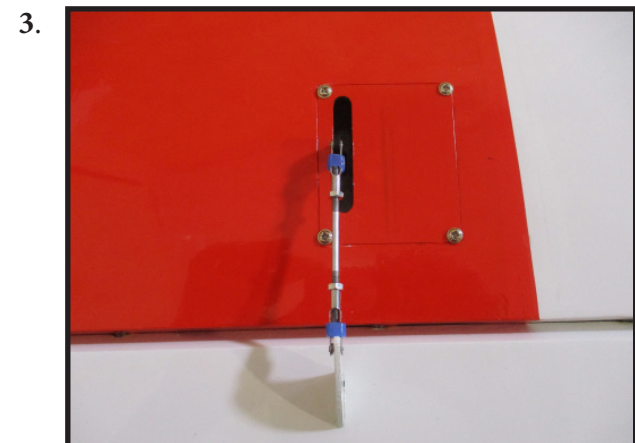
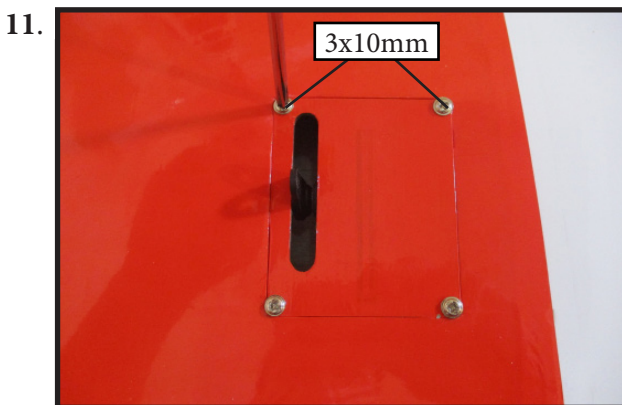

## INSTALLING THE FLAP PUSHROD

Please see pictures below.

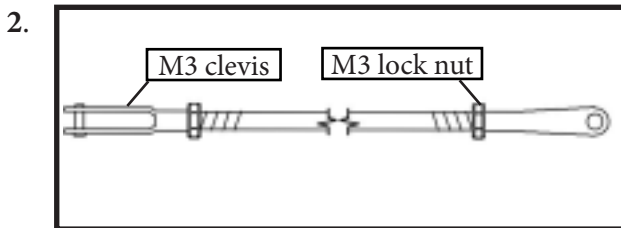
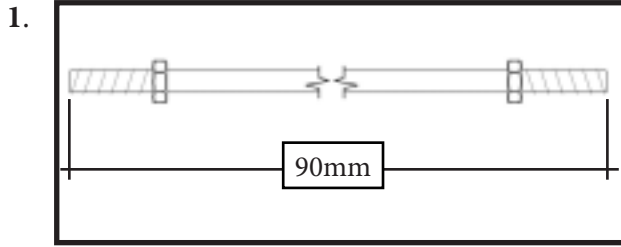

Attach the flap servo to the flap servo cover. Center the flap servo (or set the values to 0 for both up and down) and install the servo arm perpendicular to the servo centerline. The clevis will attach to the arm 13/16 inches (21mm) from the center of the arm.

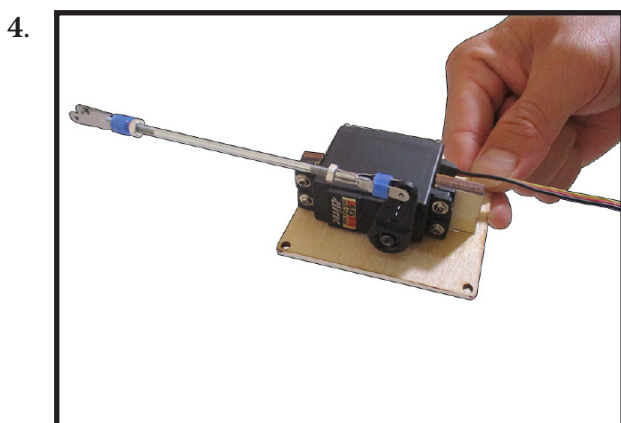
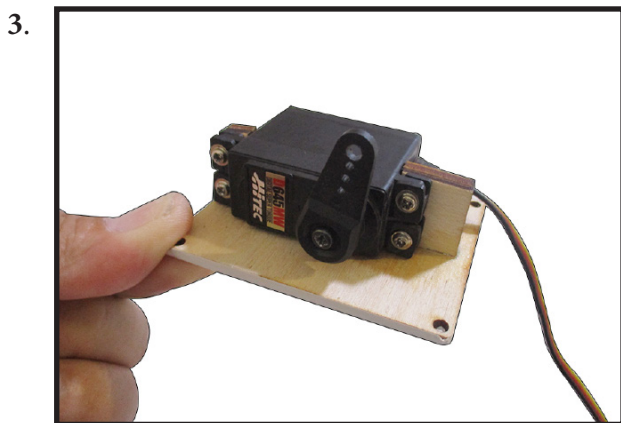

Attach the flap linkage to the control horn. Slide the clevis retainer over the forks of the clevis.

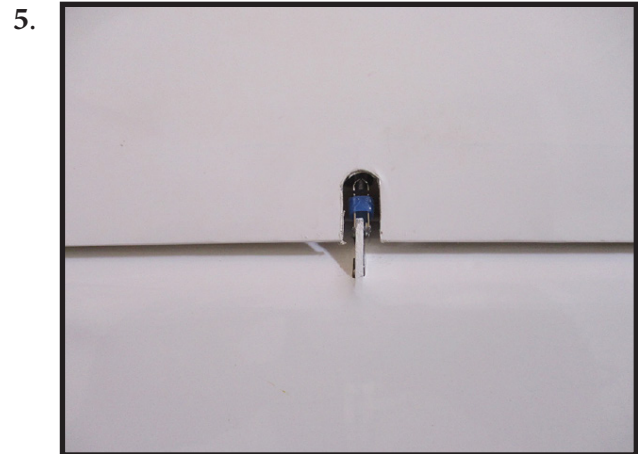

Attach the clevis to the flap servo arm.

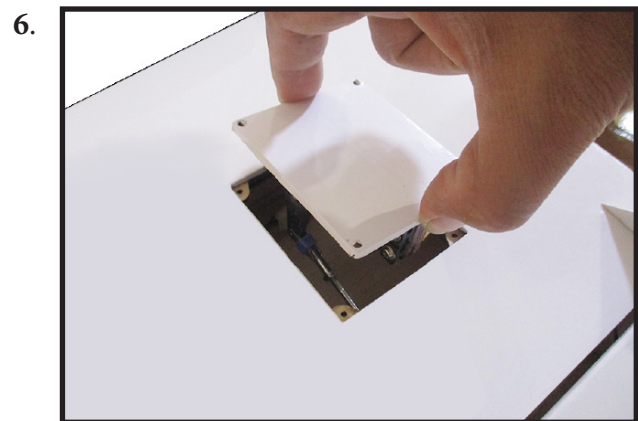

Use a pin vise and 3/32-inch (2mm) drill bit to clear the paint from the flap control horn.

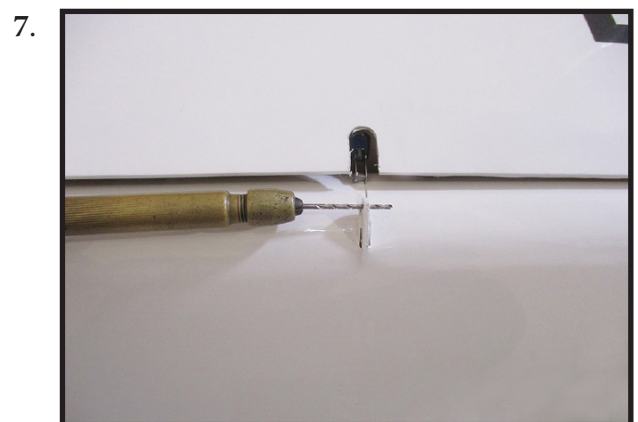

Route the servo lead for the flap servo out at the root of the wing. Connect the flap servo to the radio system. With the radio system on, place the flap servo into position.



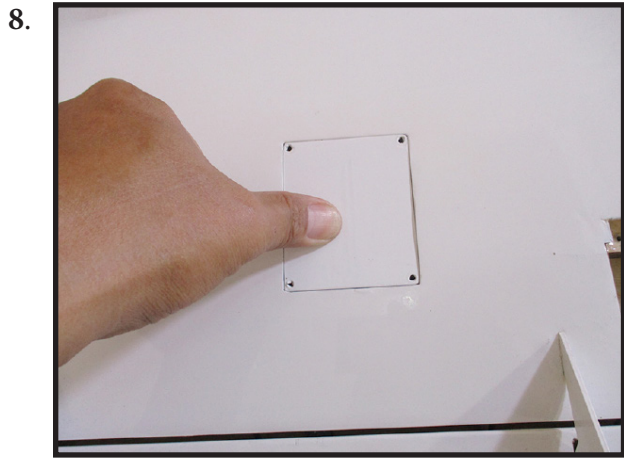

Adjust the linkage so the flap is in the mid-flap position. It may take a few tries to properly adjust the linkage.

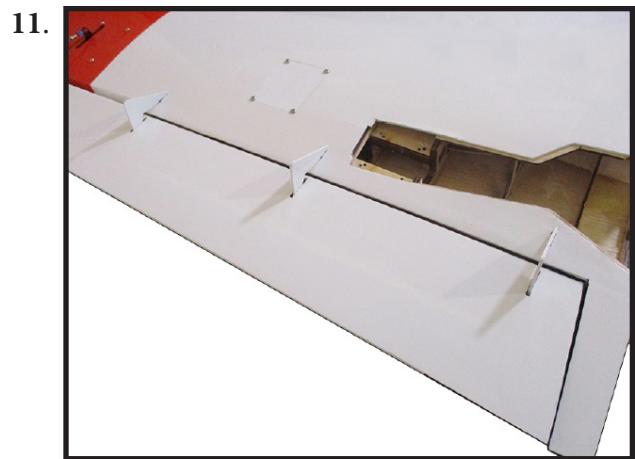

Set the flap control at the transmitter to the down flap position. Adjust the flap travel at the transmitter until it matches the control throws listed in this manual.

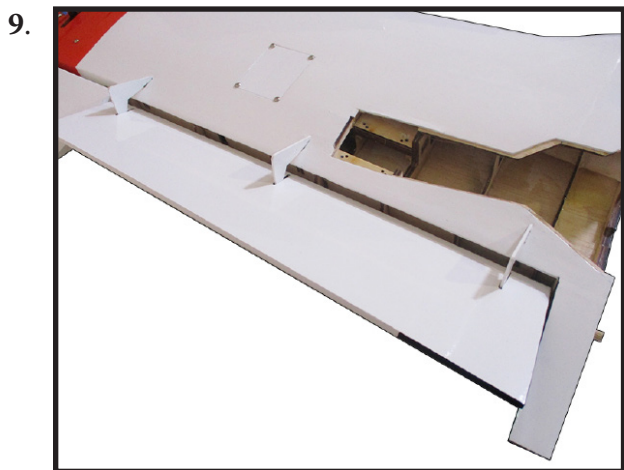

Once adjusted, make sure all clevis retainers are in position. Apply a drop of threadlock near the clevis, then tighten the nut against the clevis to keep the linkage from changing length inside the wing.

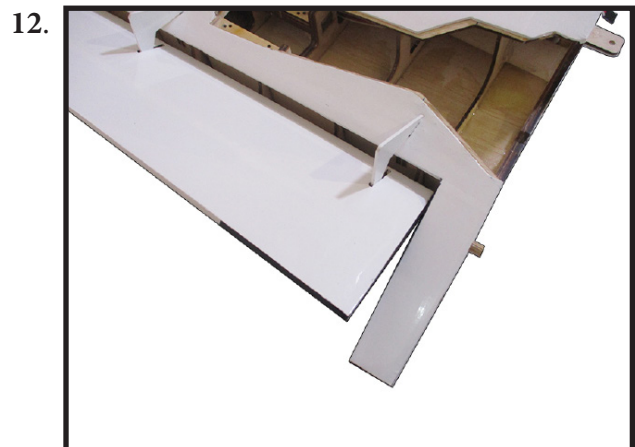

Trim the flap linkage cover using a hobby knife, hobby scissors and some fine sandpaper as needed.

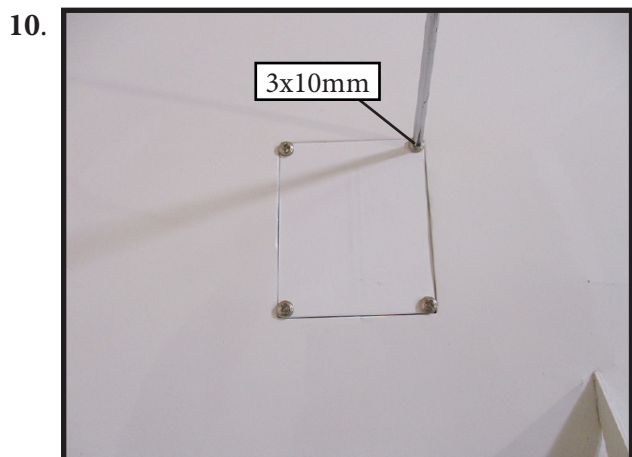

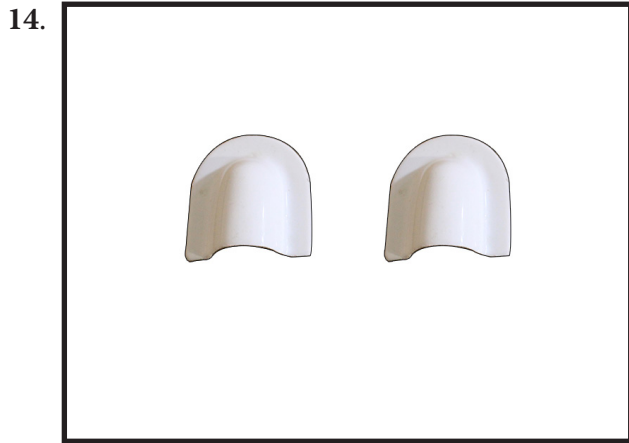

Fit the flap linkage cover into position. Check the operation of the flap to make sure the cover does not interfere with the flap linkage.



Use canopy glue to attach the cover to the wing. Use low-tack tape to keep the cover in position until the adhesive fully cures. Blue painters tape works well !



**INSTALLING ROBART LANDING GEAR**

**ROBART** landing gear are not included. Please study images below for proper installation. You may install electric or pneumatic gear. Fuselage has accommodations for both.

**Robart 150E MAIN GEAR 150ESP**

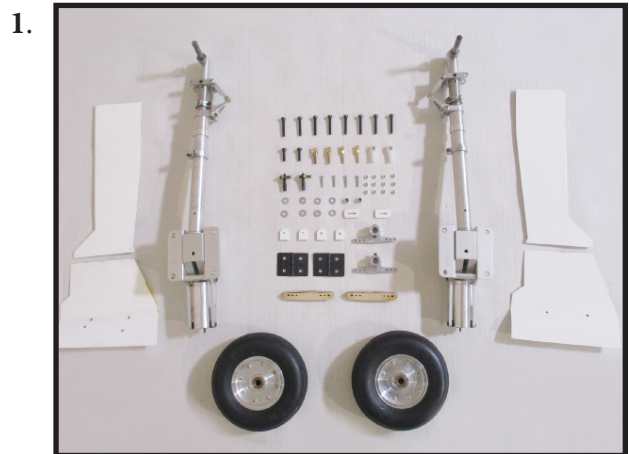

Attach hinge to front gear fairing and wing.

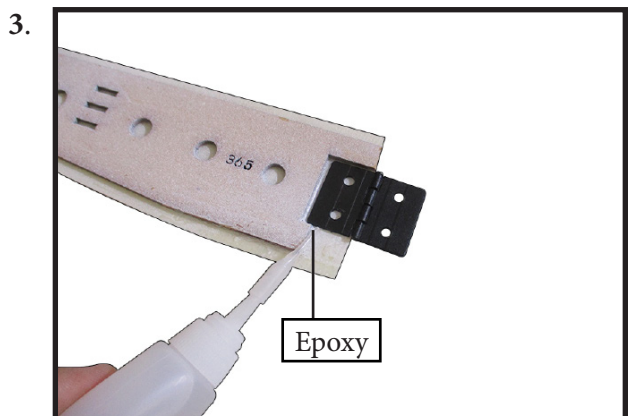
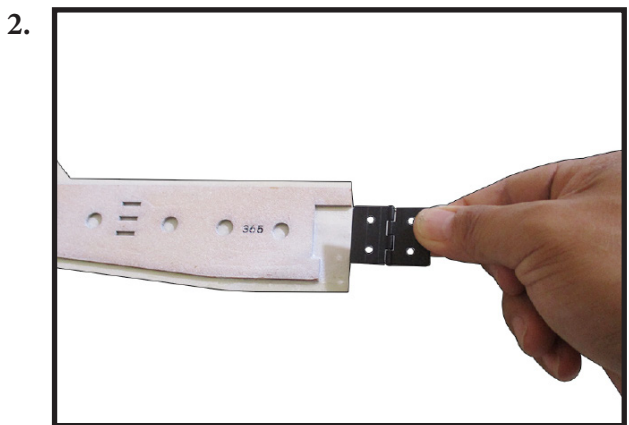



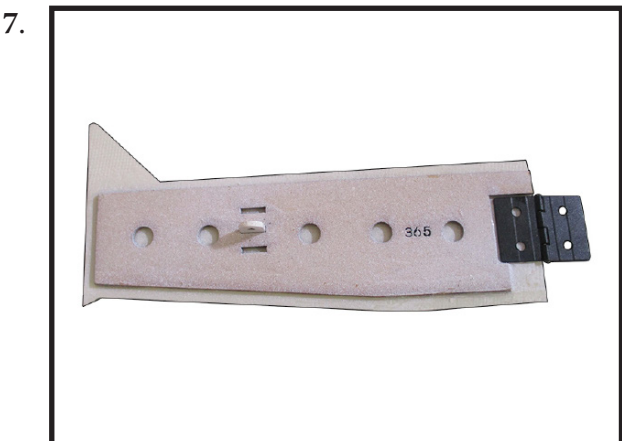
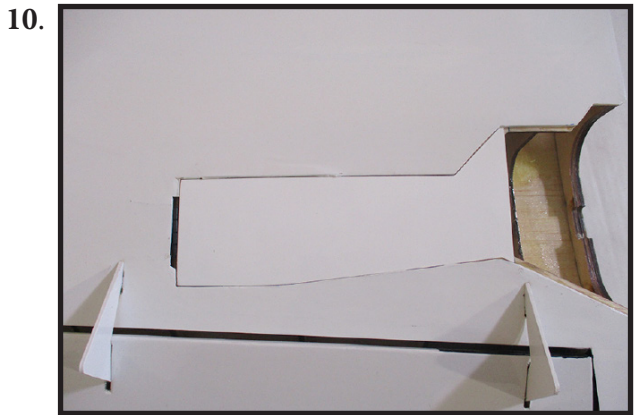
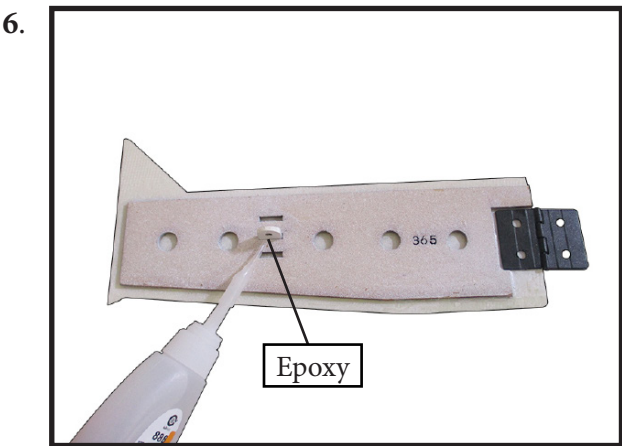
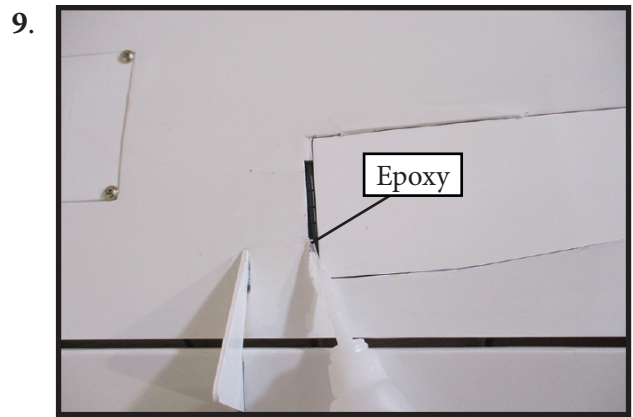
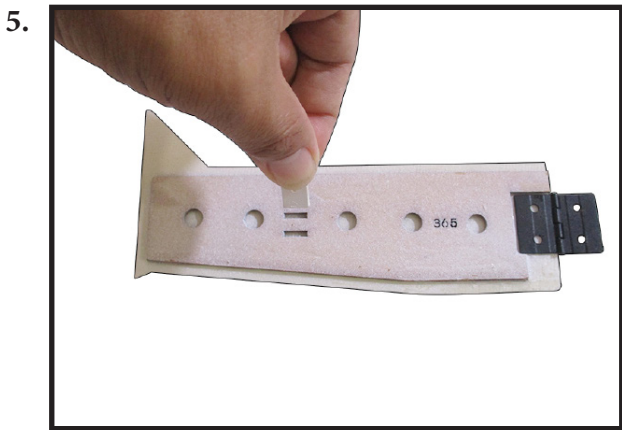
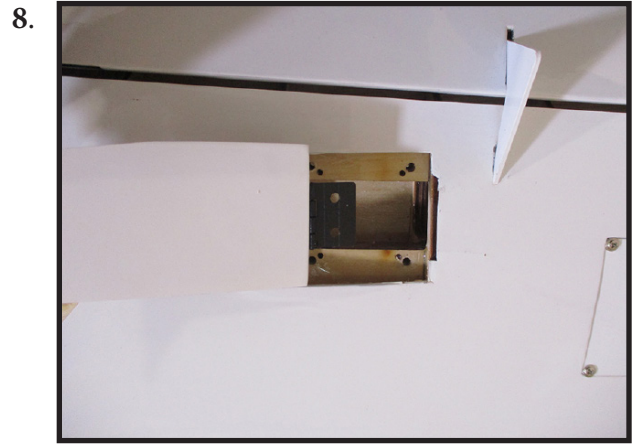
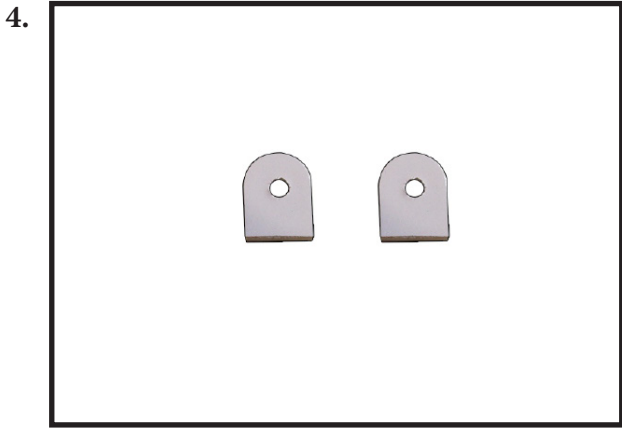

Install Main Retractable Landing Gear.

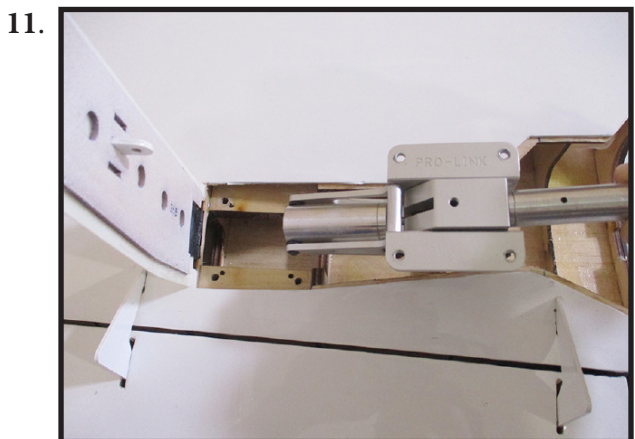

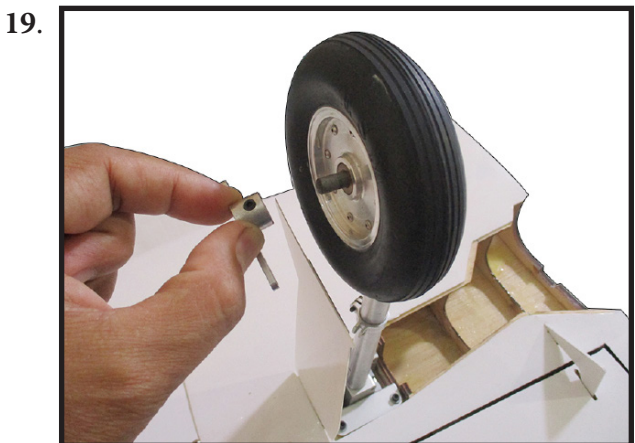
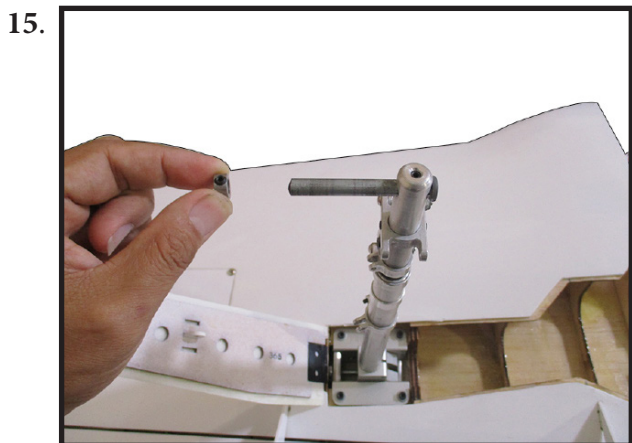
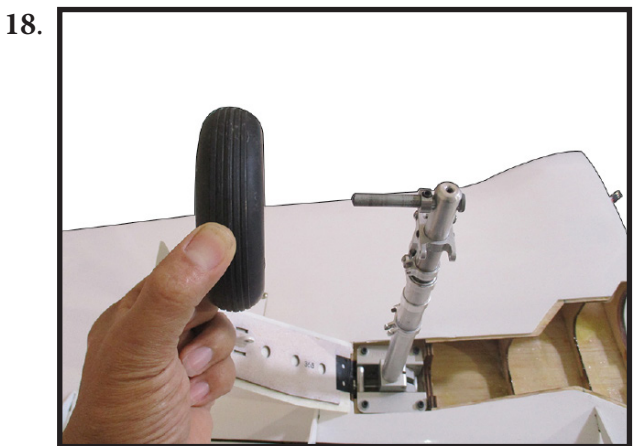
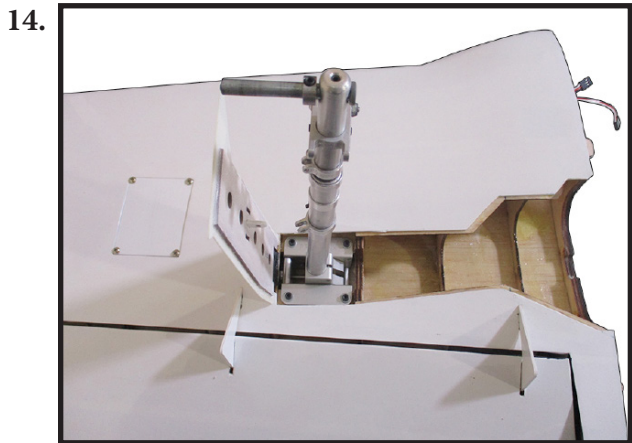
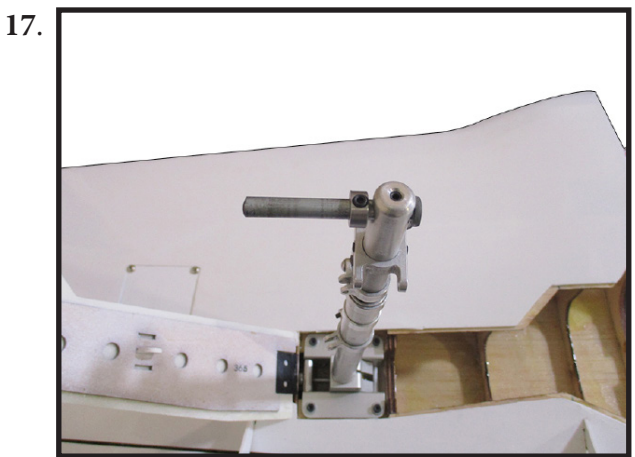
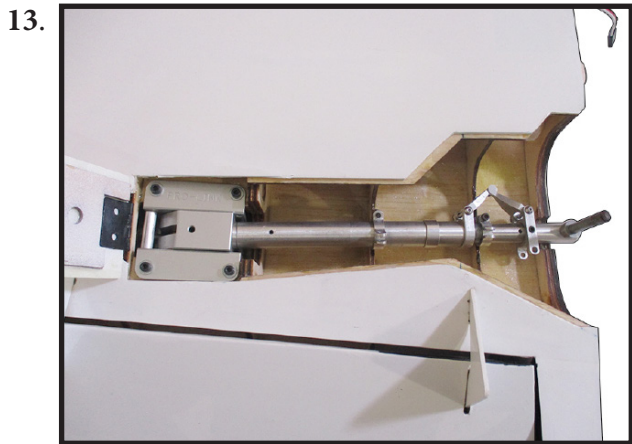
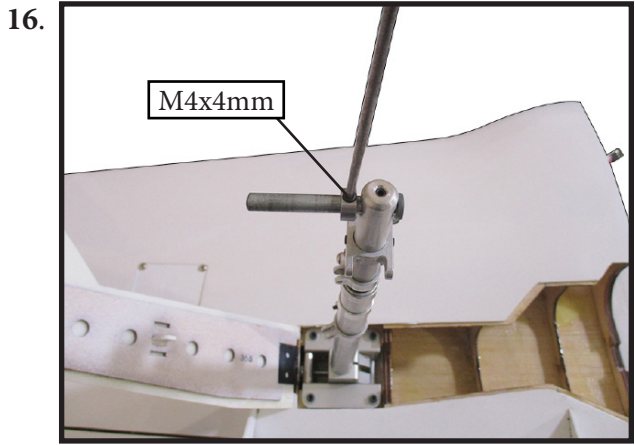
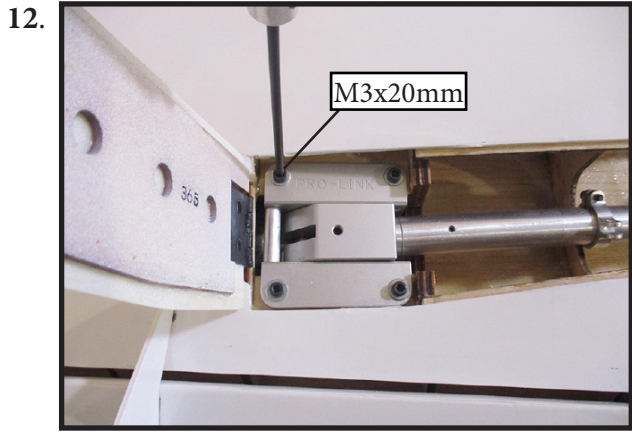



20.

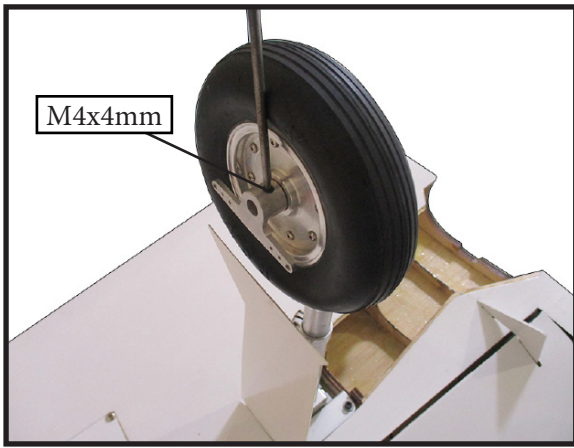

24.

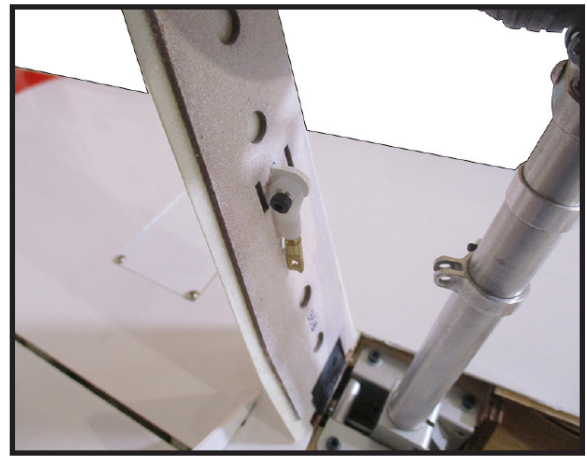

21.

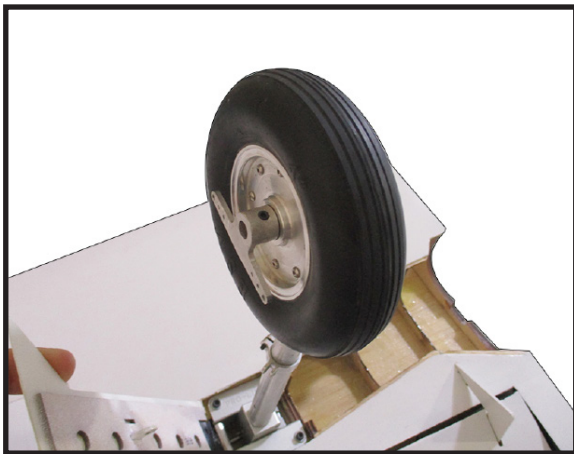

25.

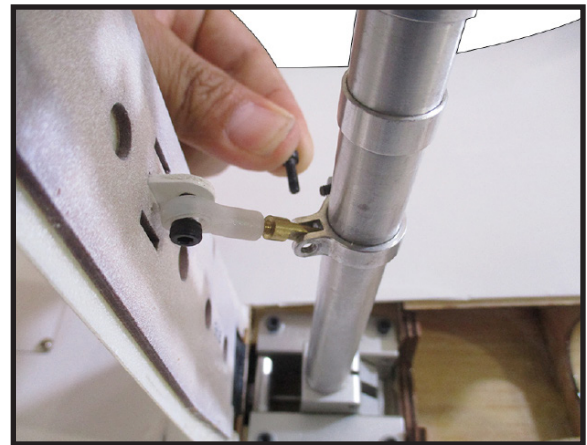

22.

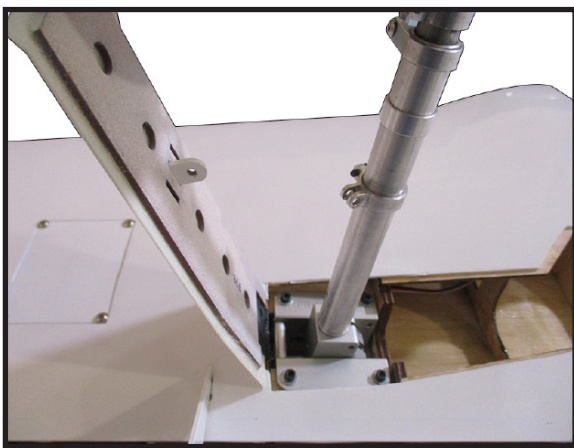

26.

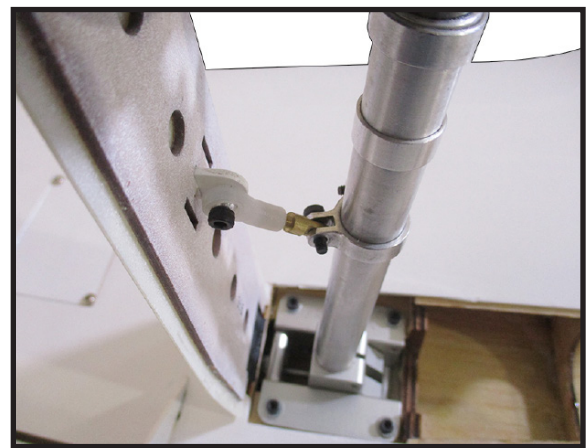

23.

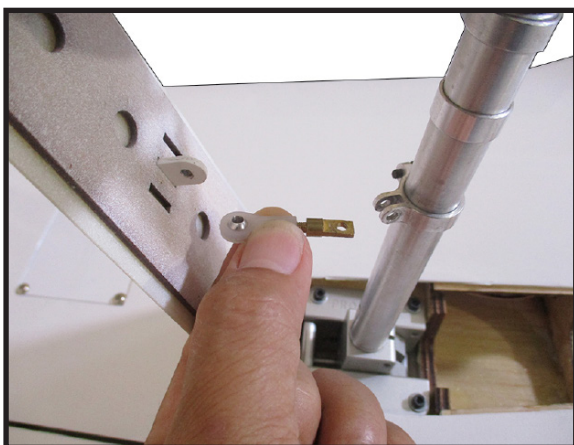

27.

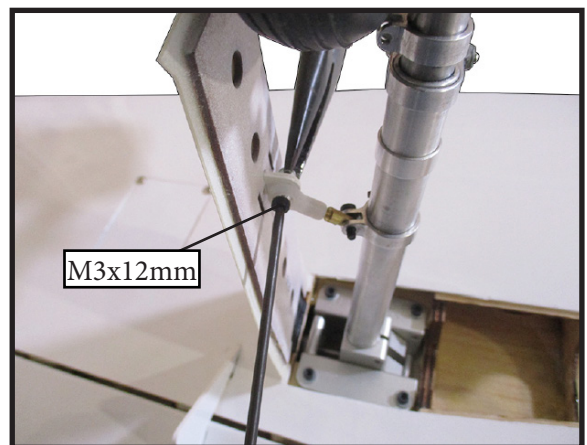



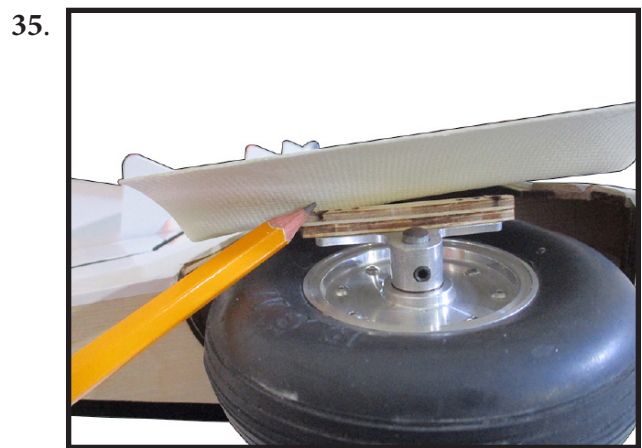
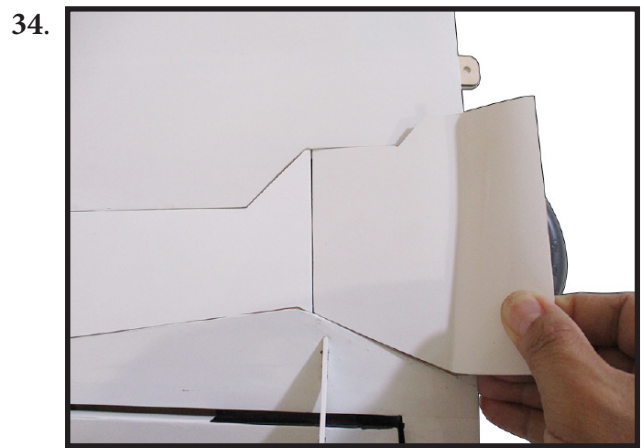
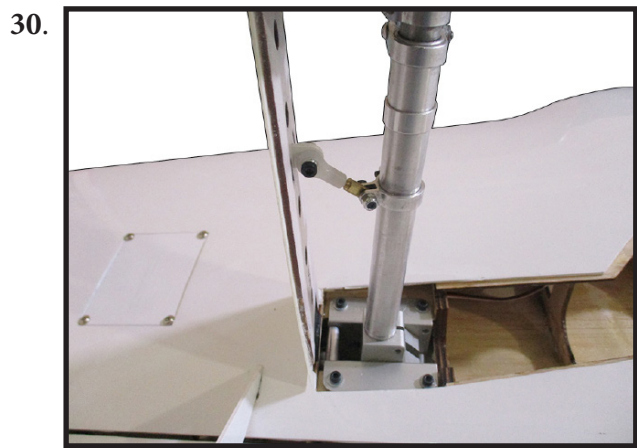
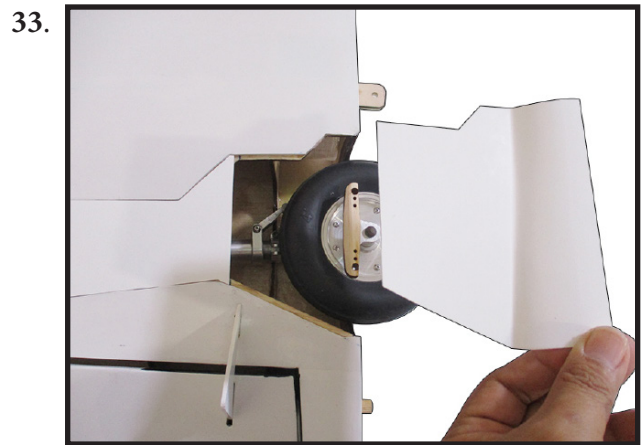
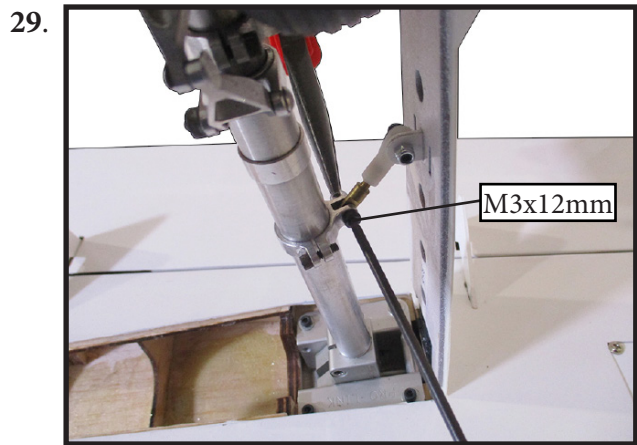
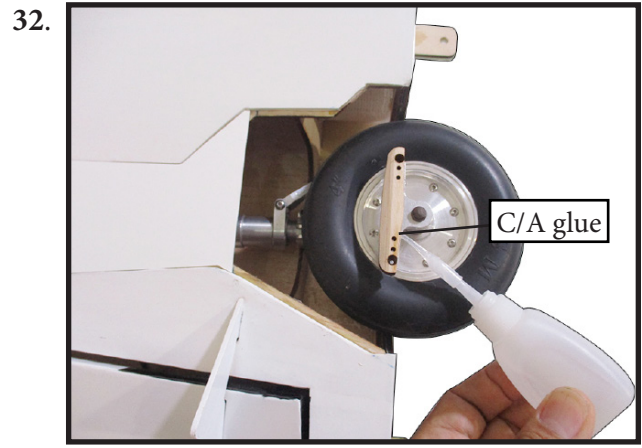
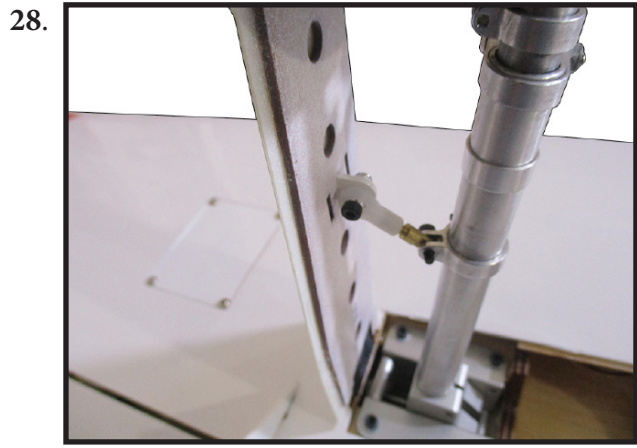

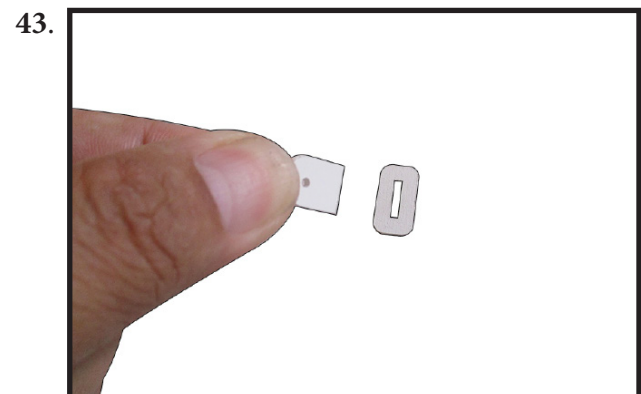
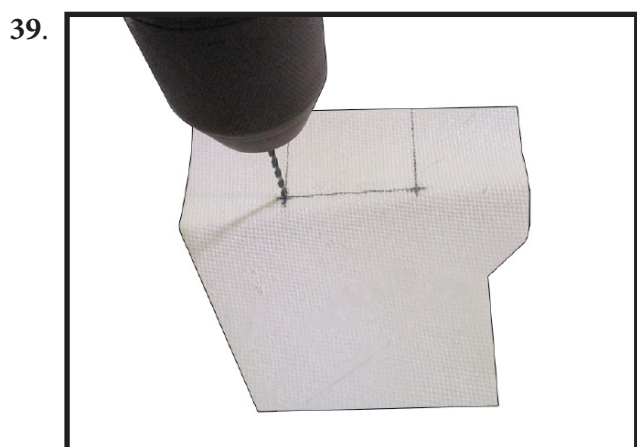
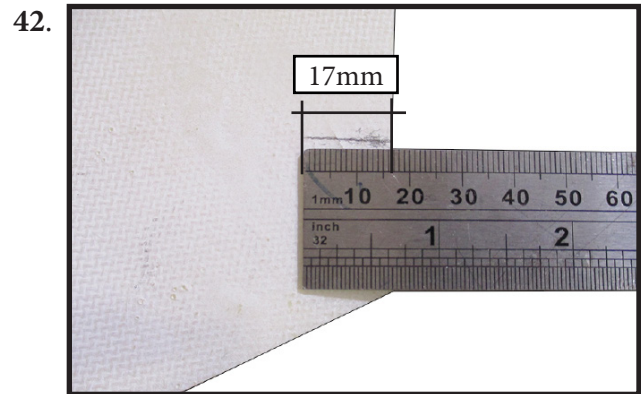
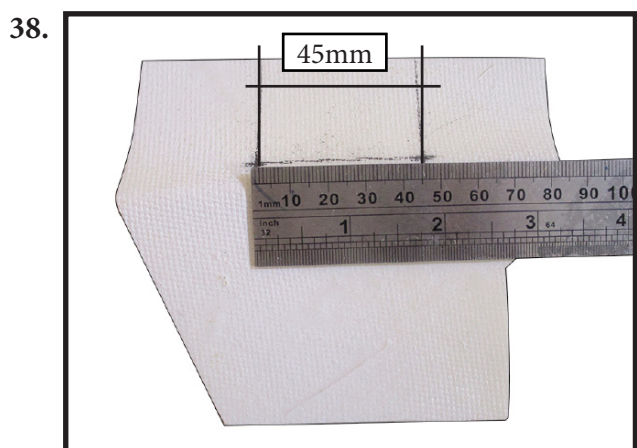
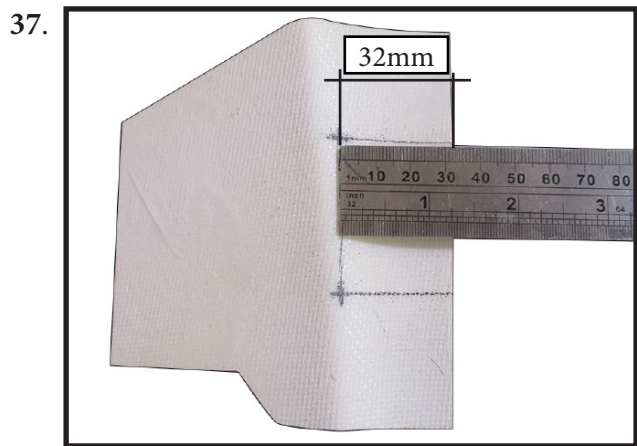
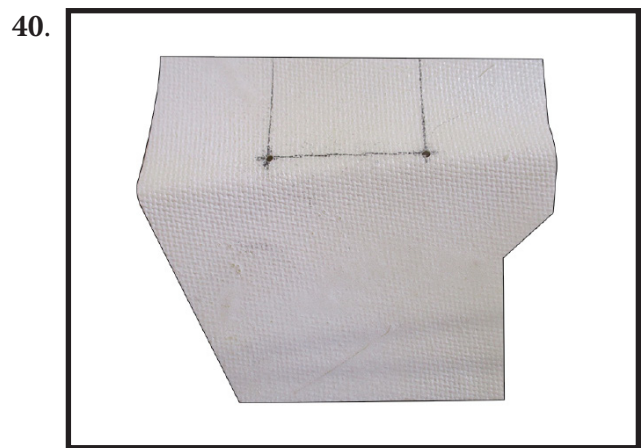
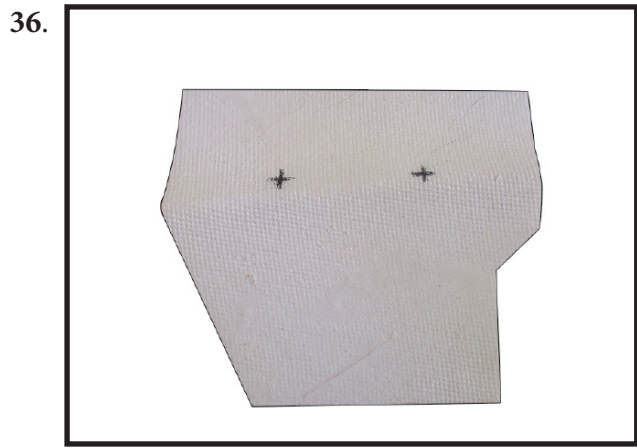

Insert gear door control horn tab into hole.



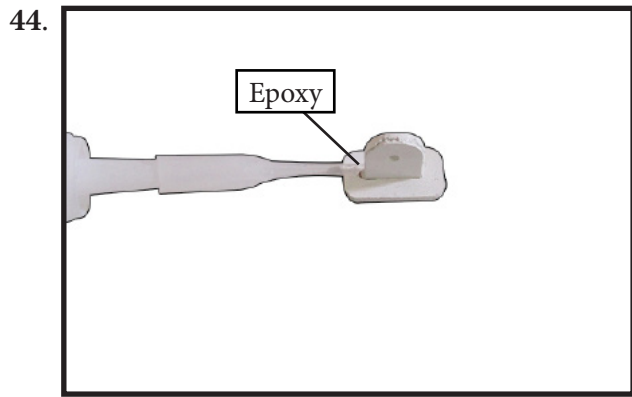

Apply epoxy glue to parts.

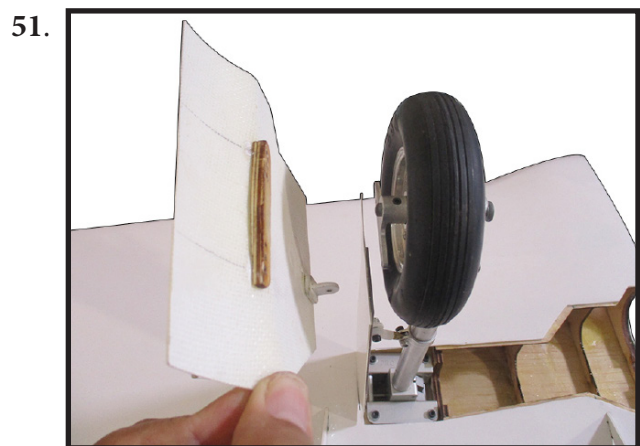
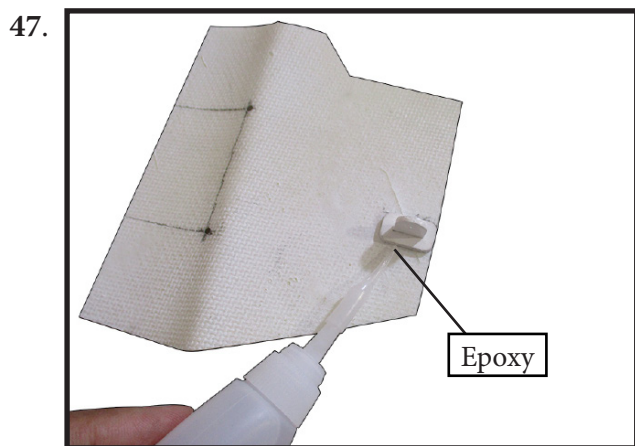
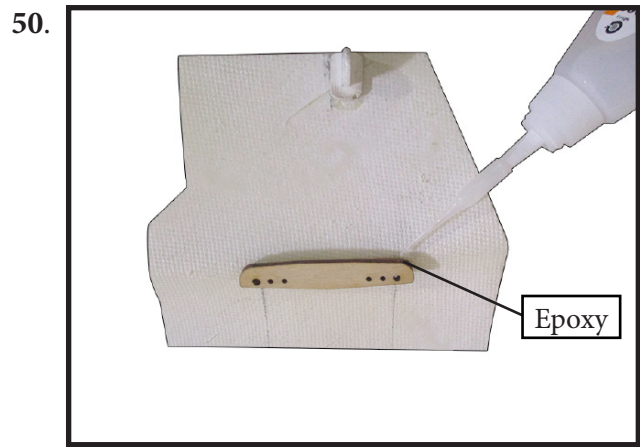
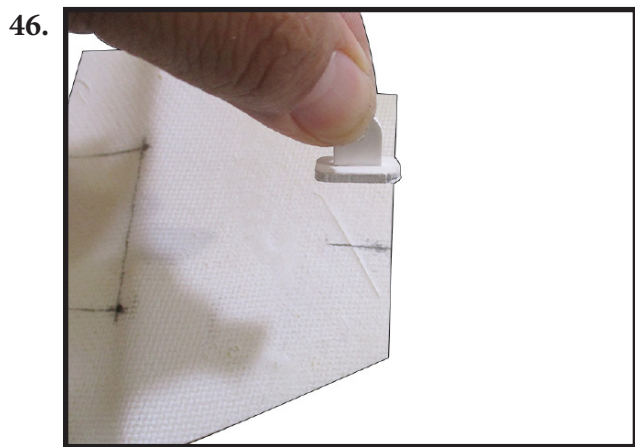
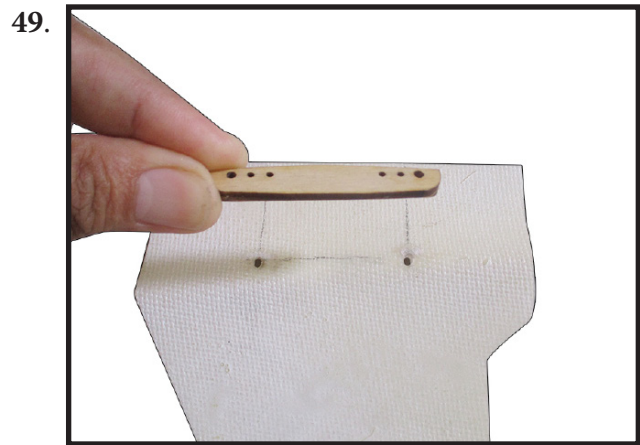
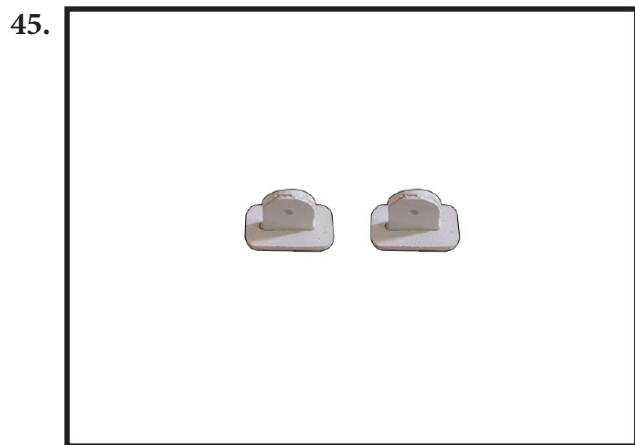
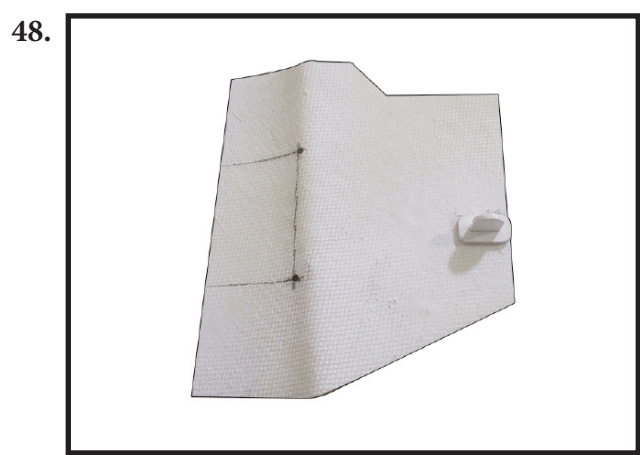



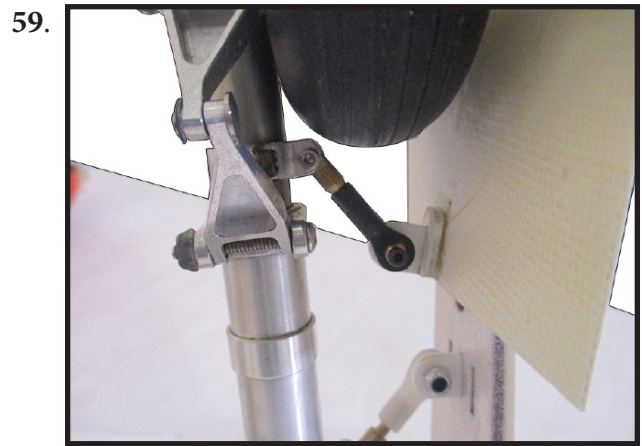
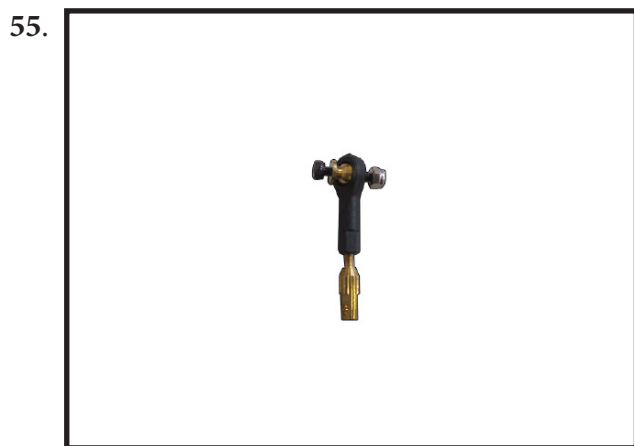
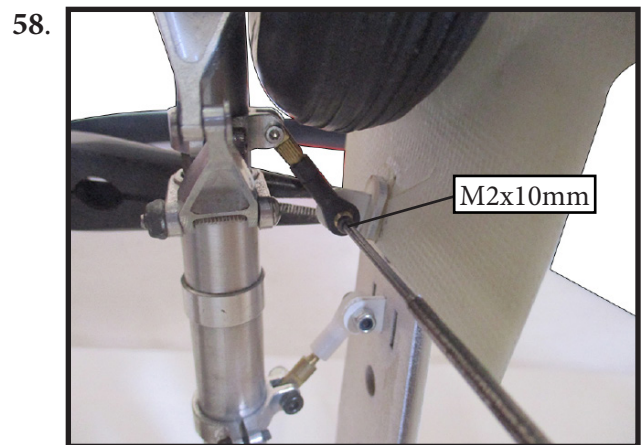
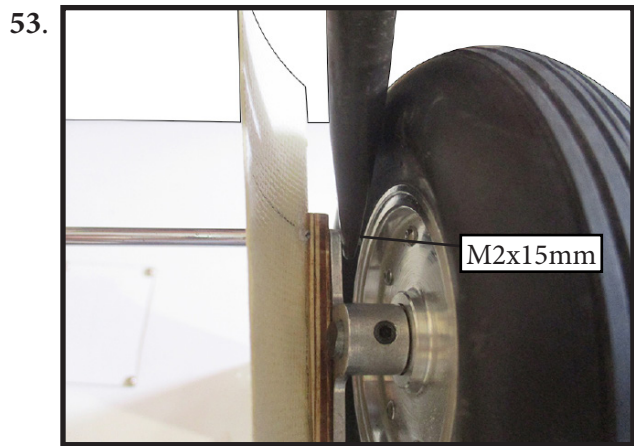
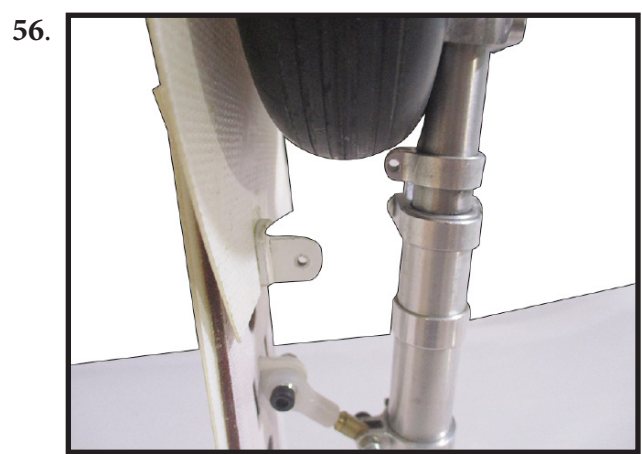
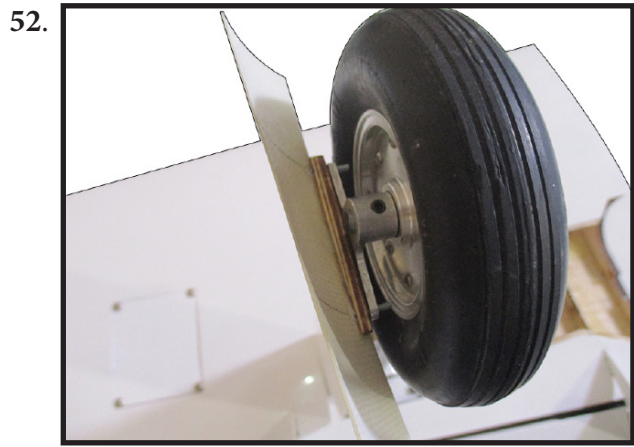

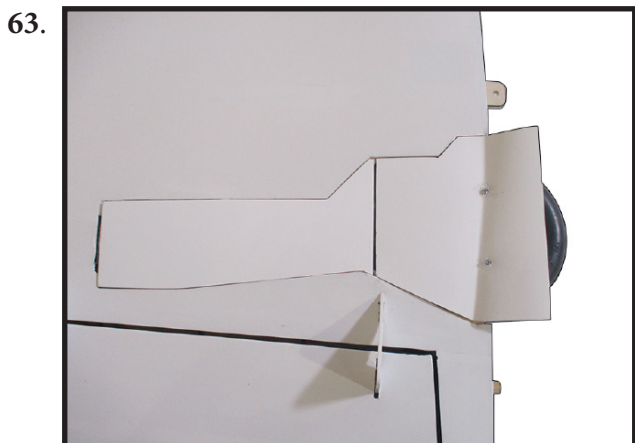

### INSTALLING RETRACTABLE LANDING GEAR

- Locate items necessary to install Sprin Landing Gear.

You use this fork set JP ER-150 100° Retracts Rotating 90°

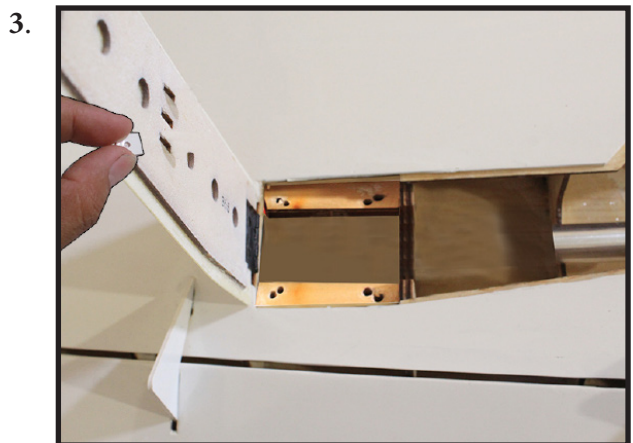
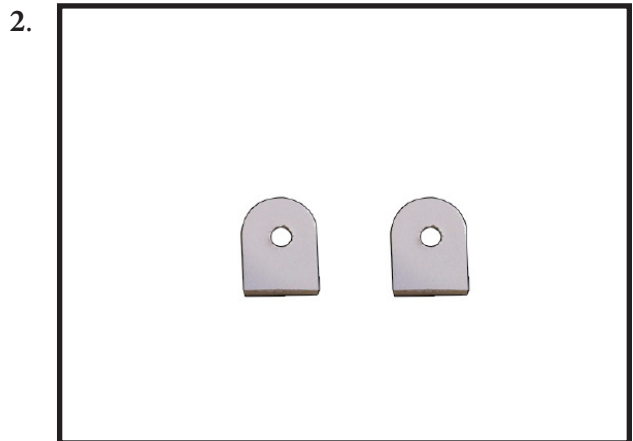
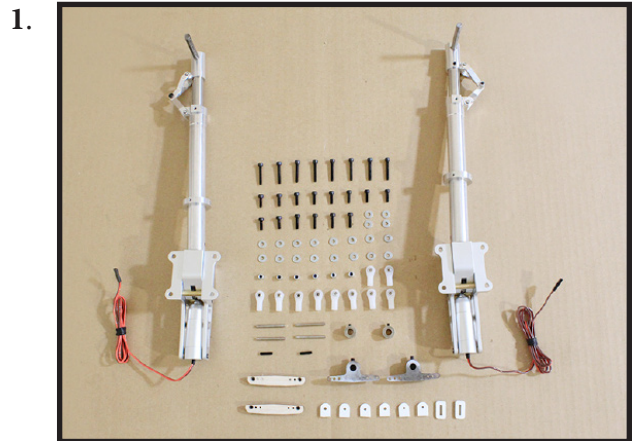



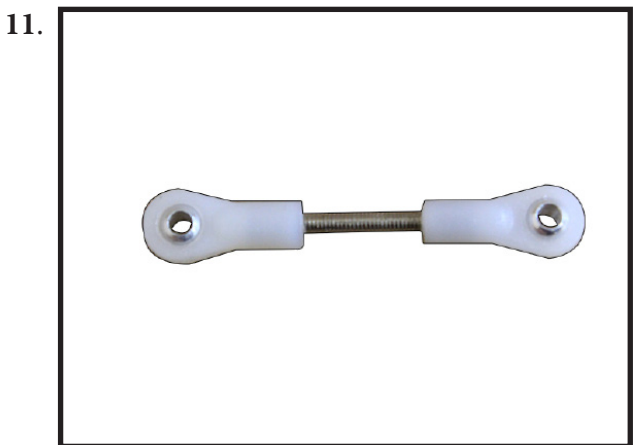
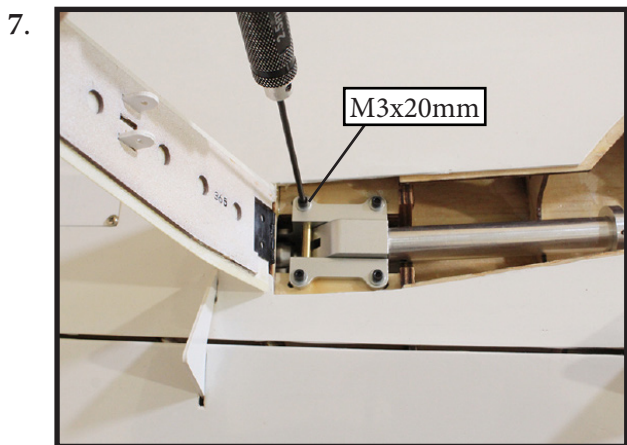
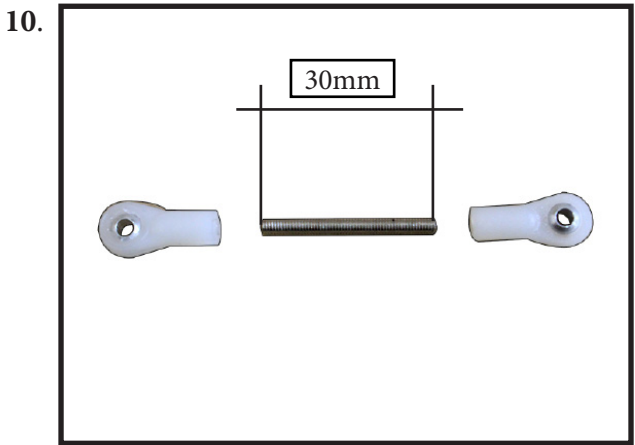
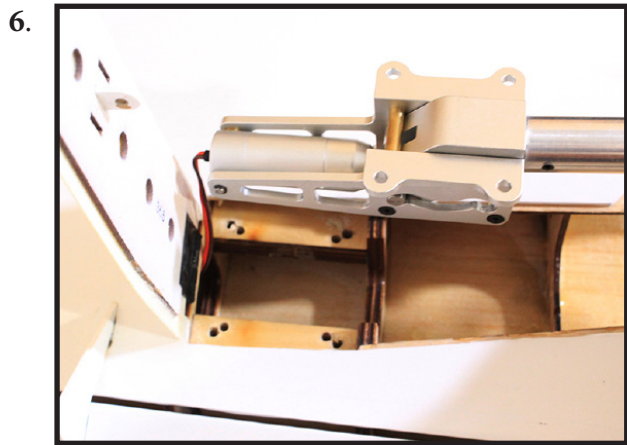
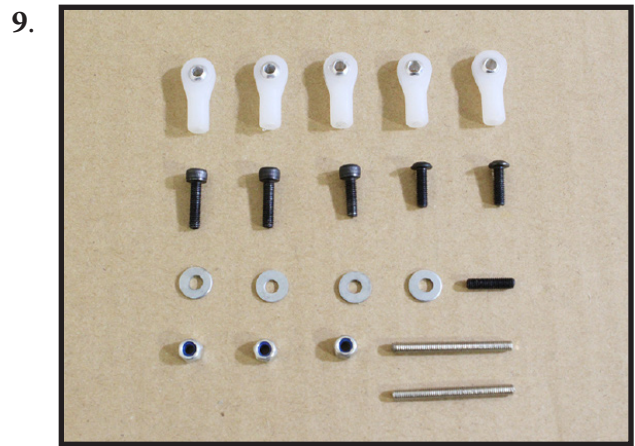
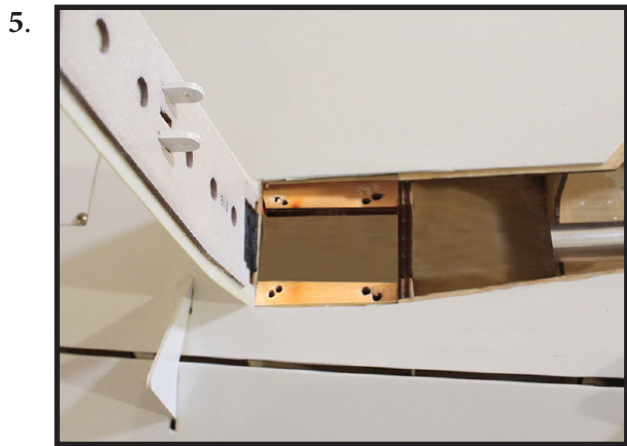
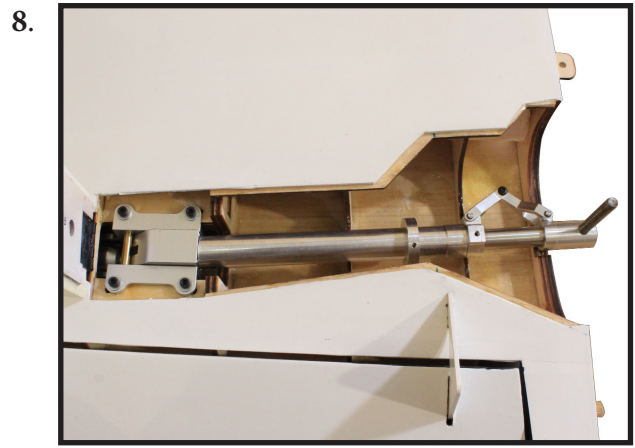
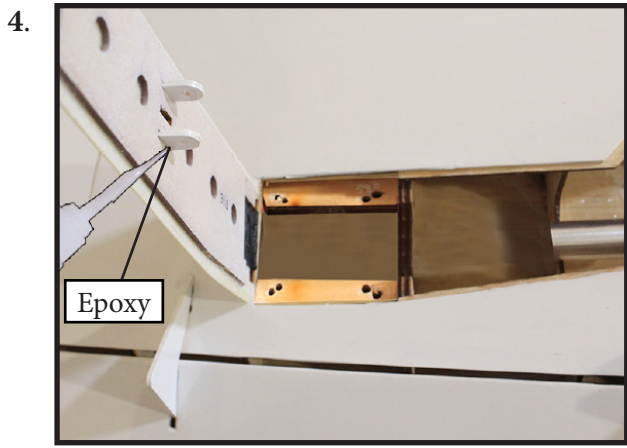



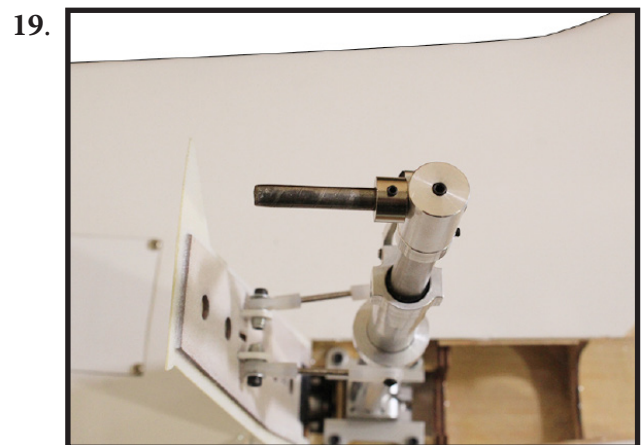
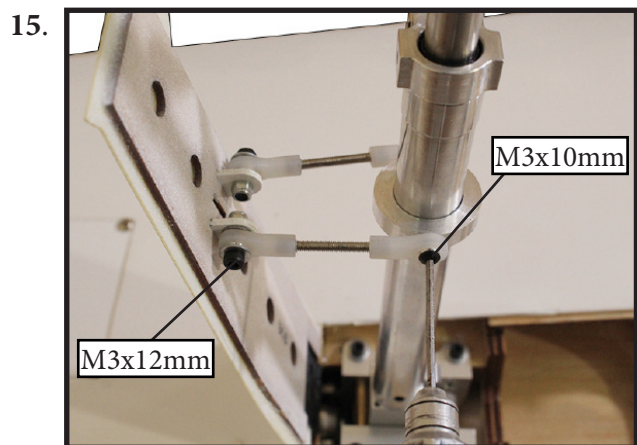
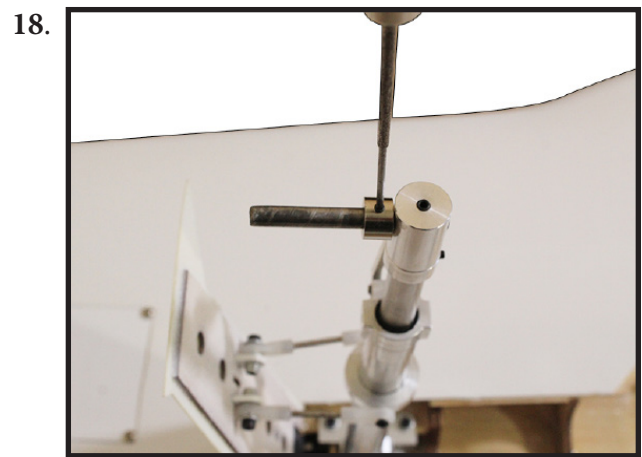
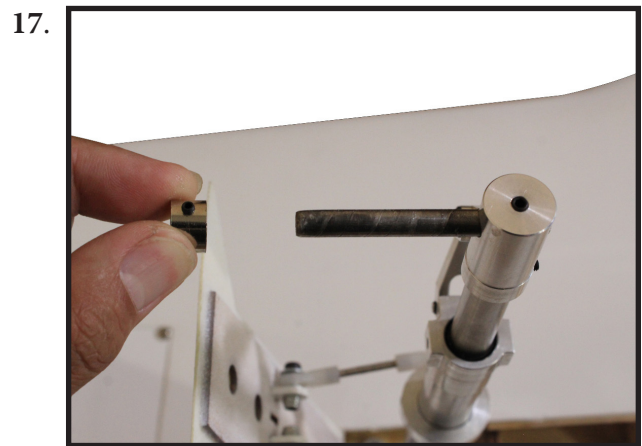
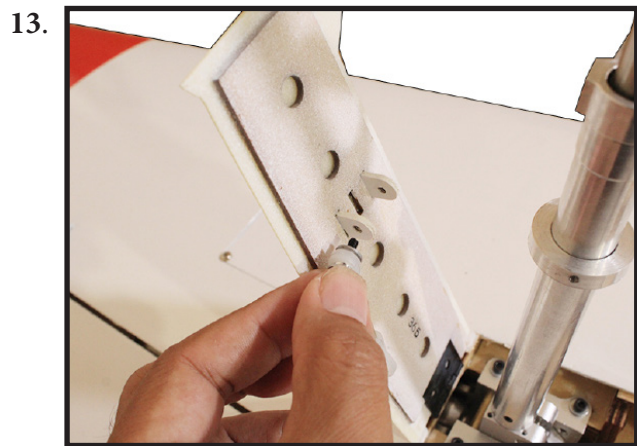
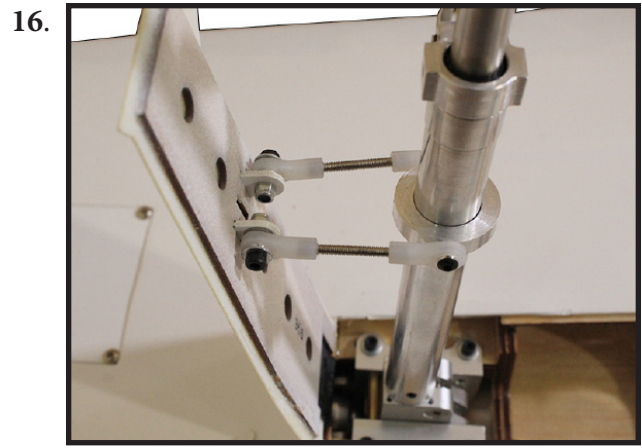
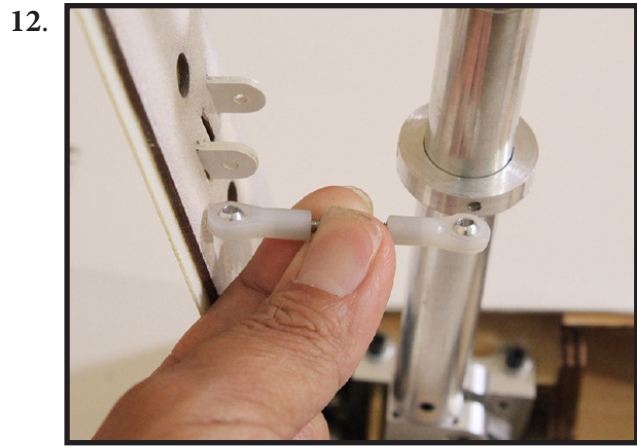

20.

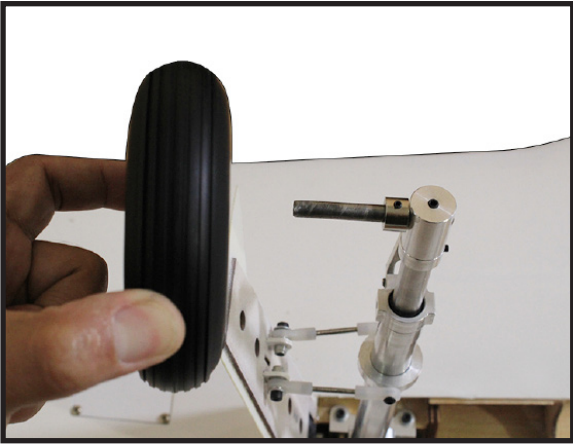

24.

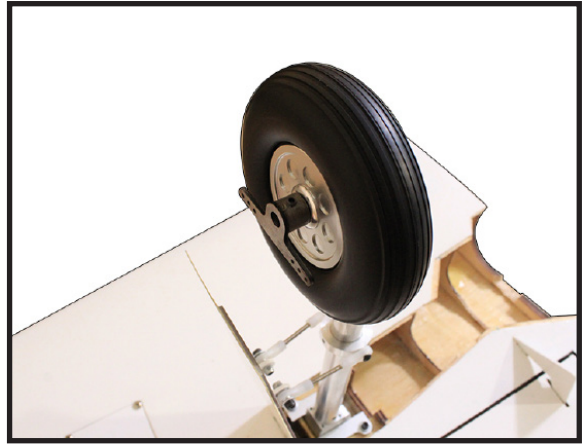

21.

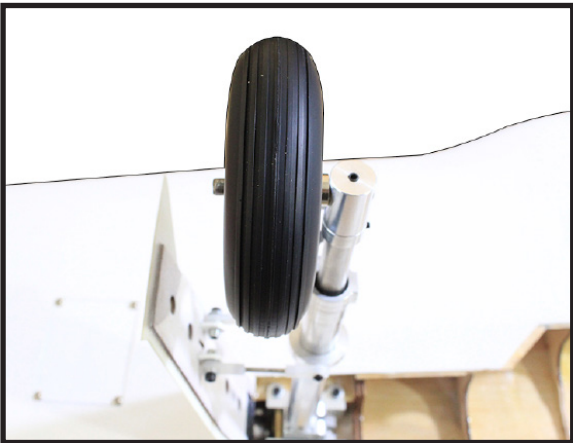

25.

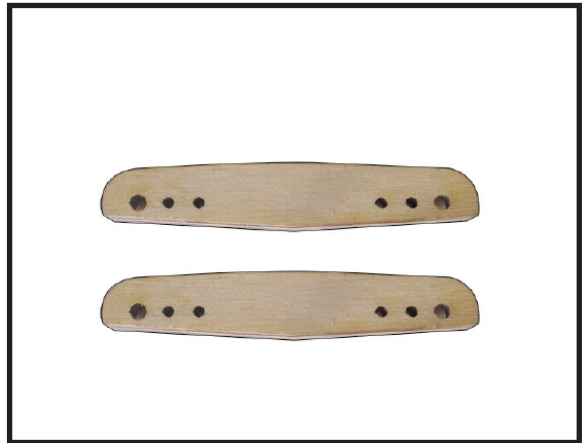

22.

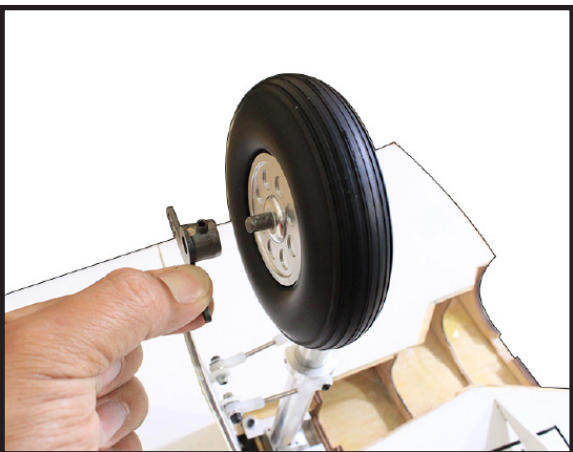

26.

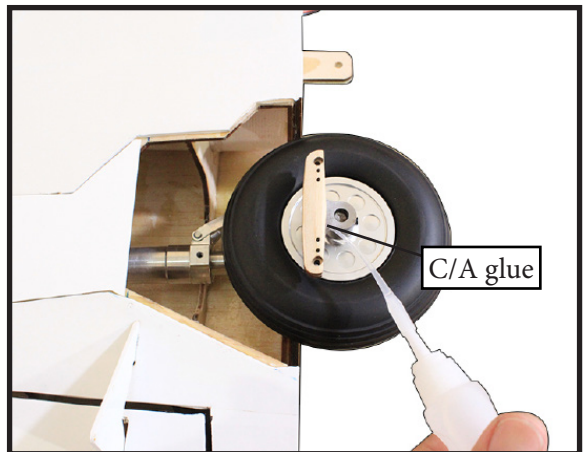

23.

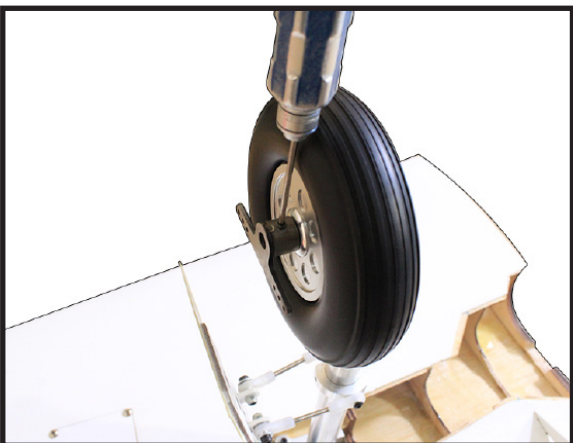

27.

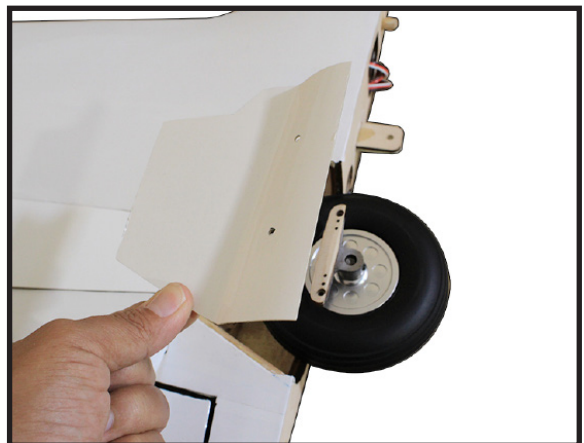



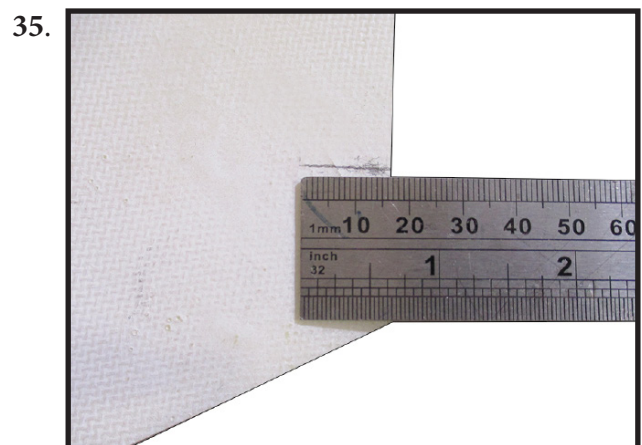
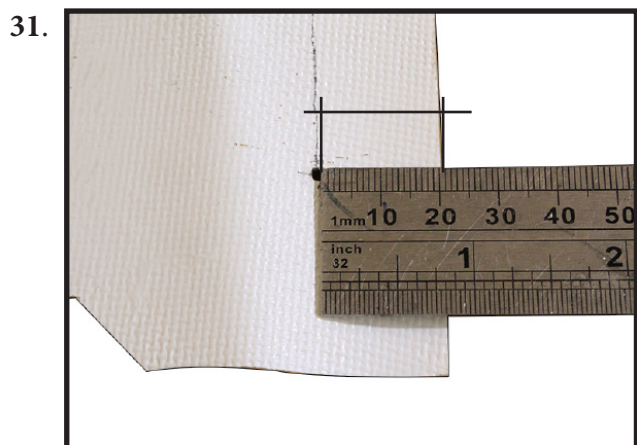
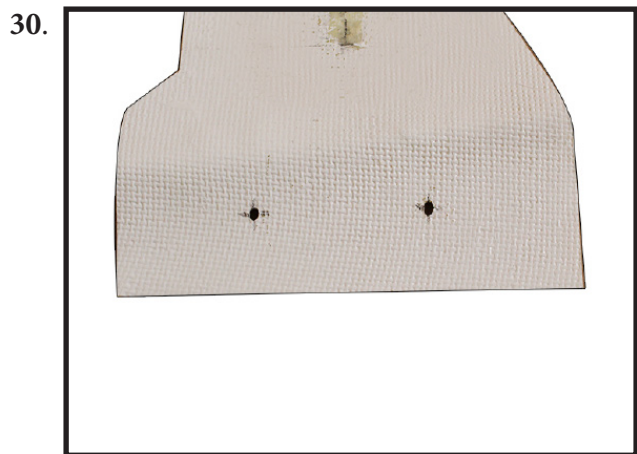
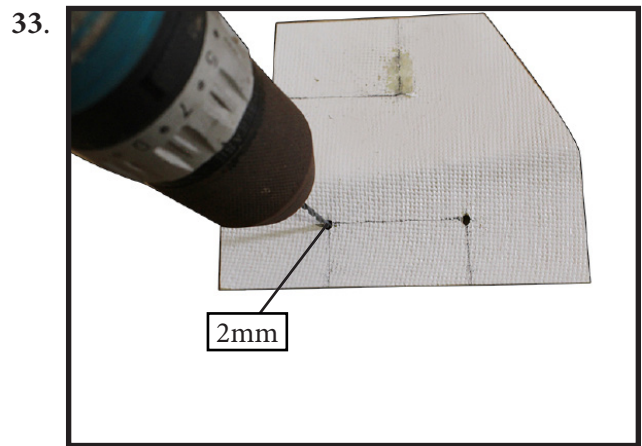
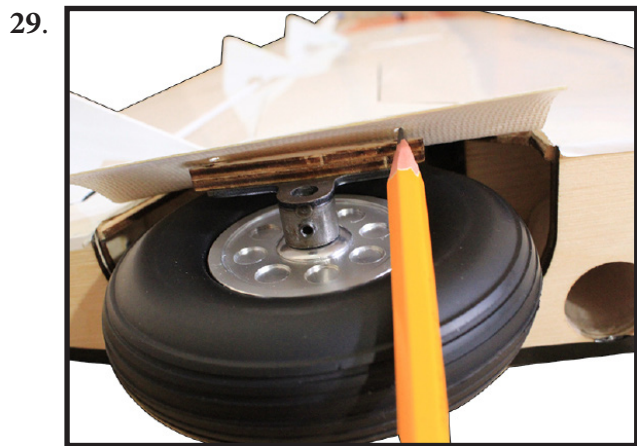
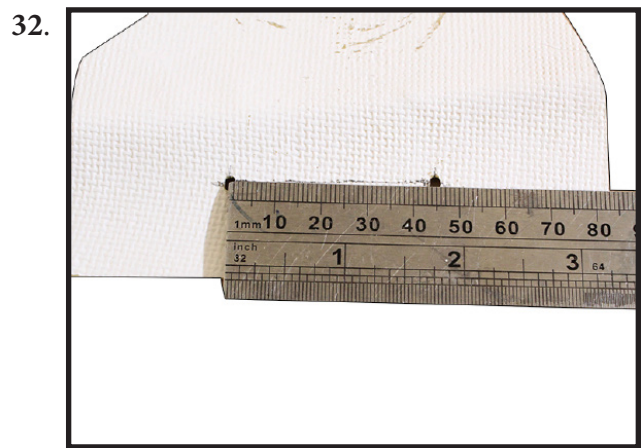
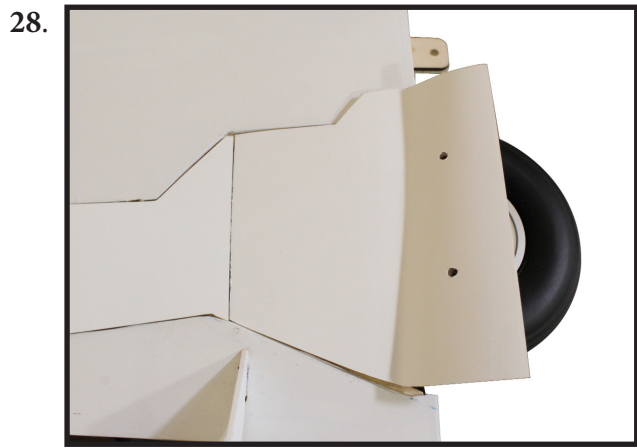



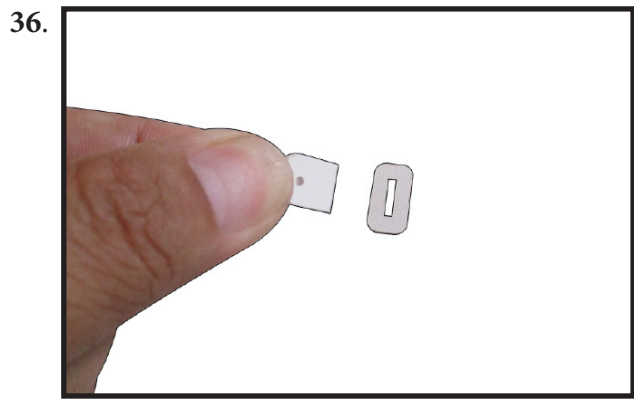

Insert gear door control horn tab into hole.

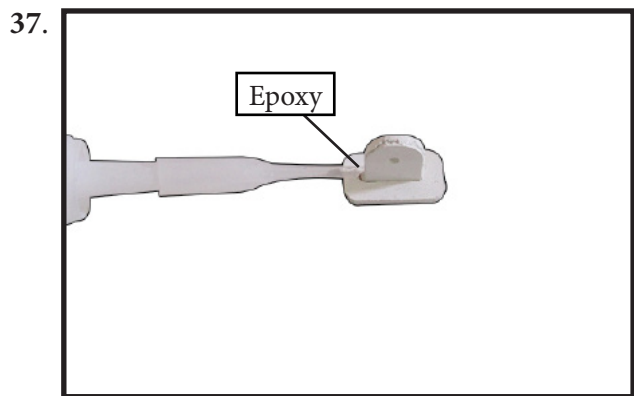

Apply epoxy glue to parts.

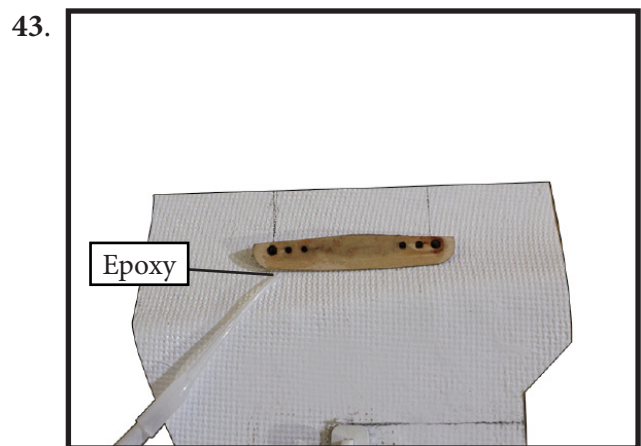
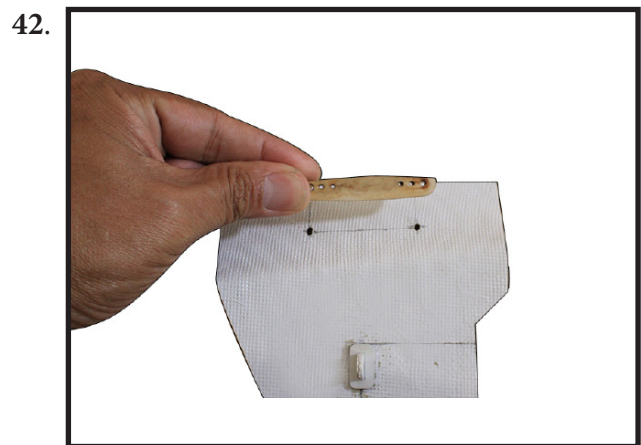
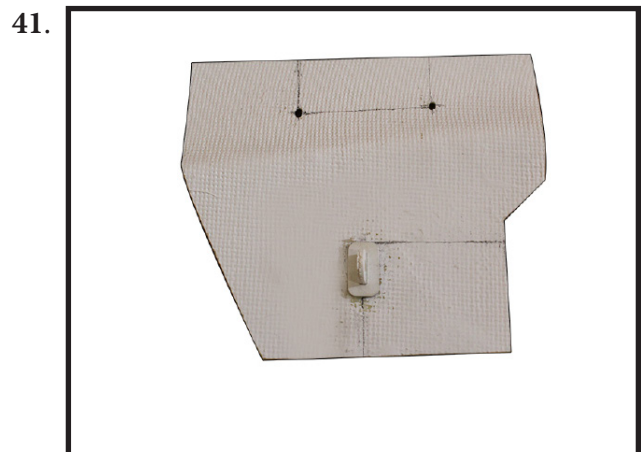
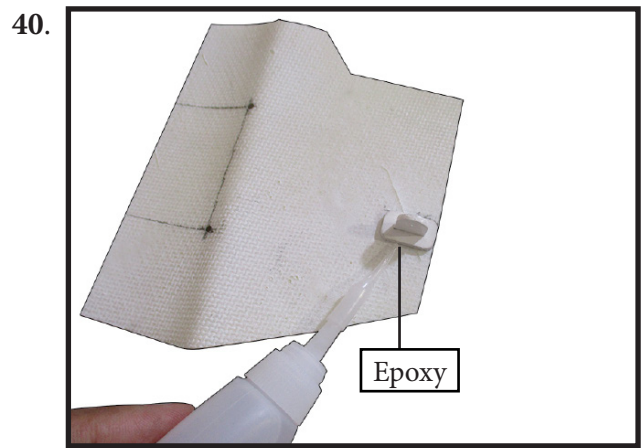
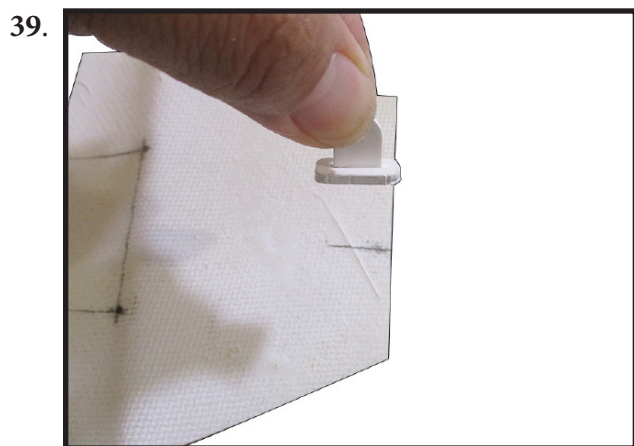
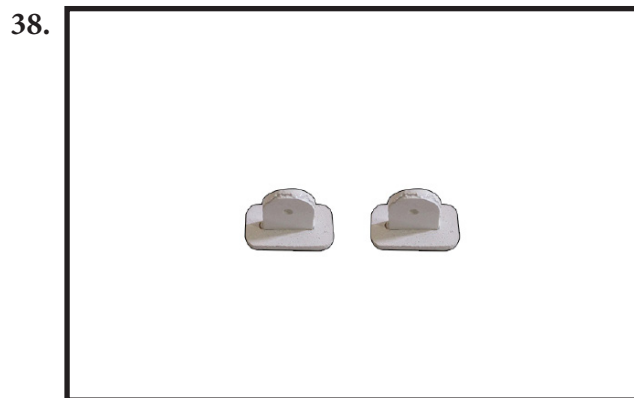

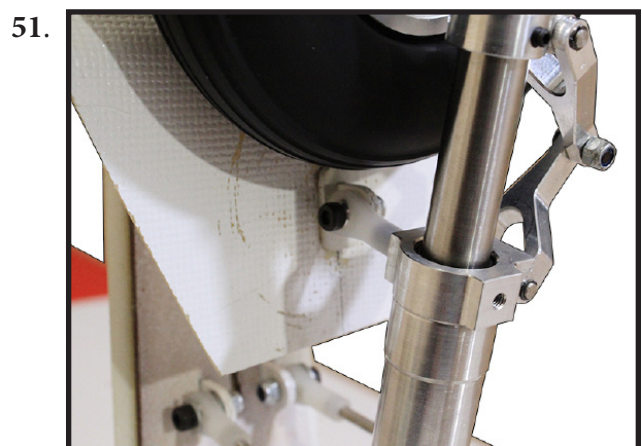
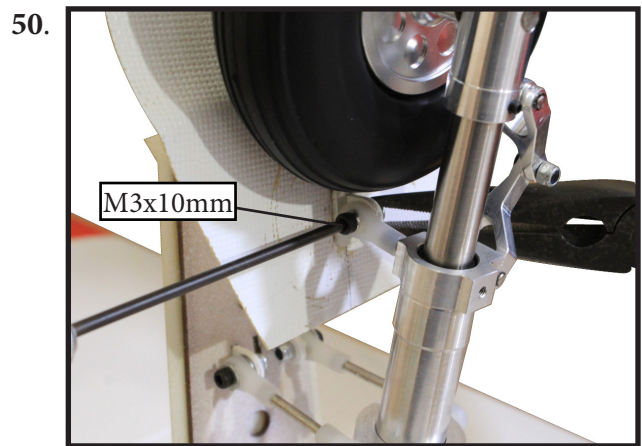
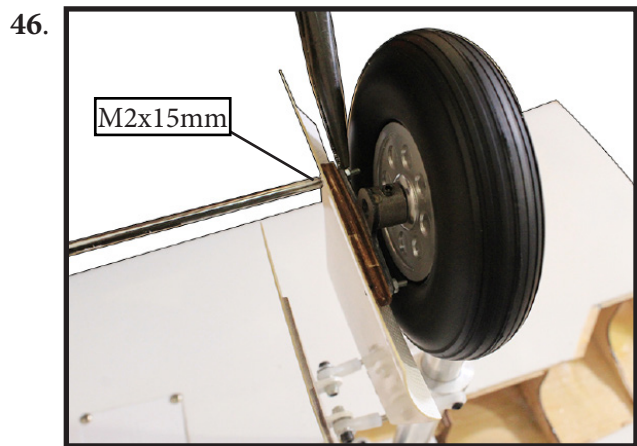
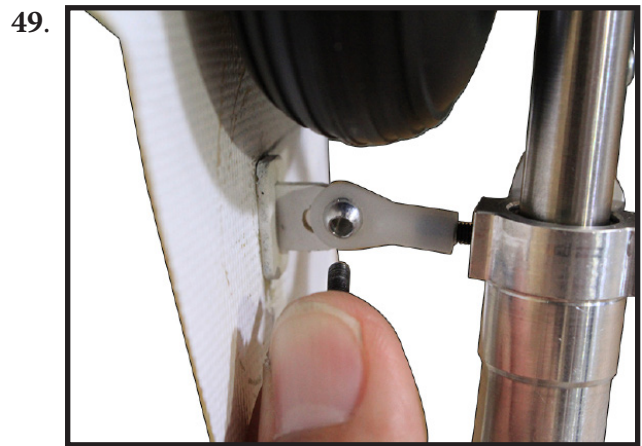
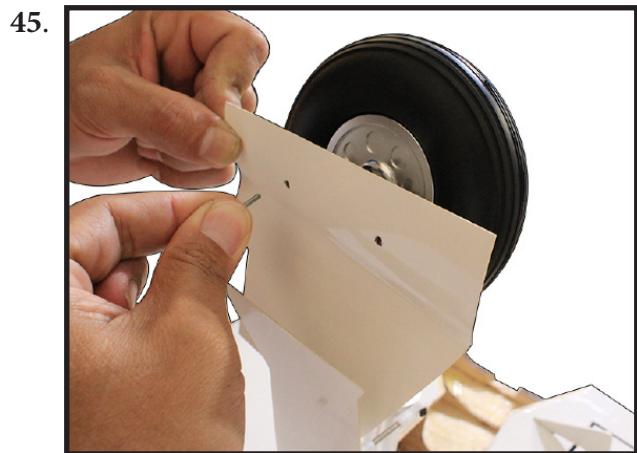
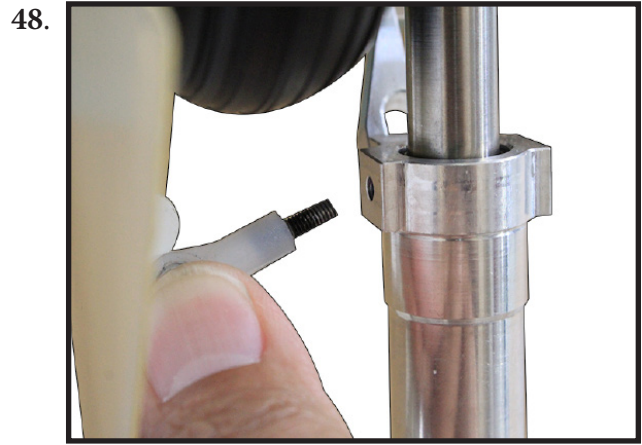
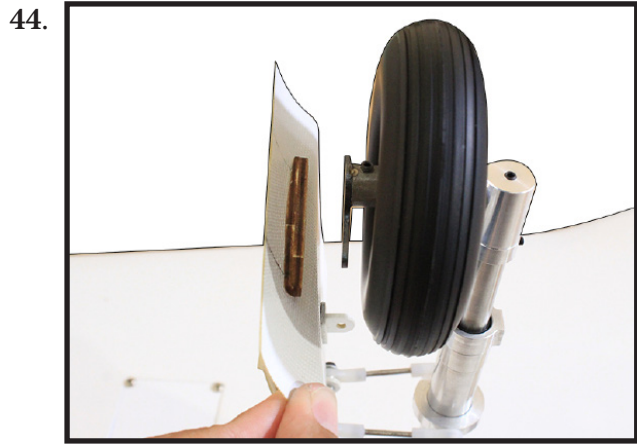



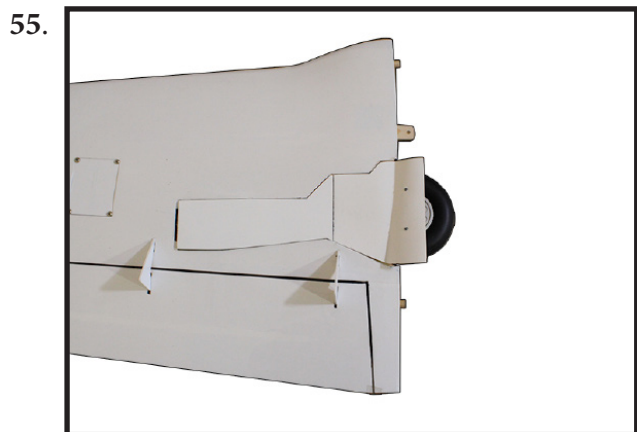

Continue Attaching the hinge to the cover and wing.

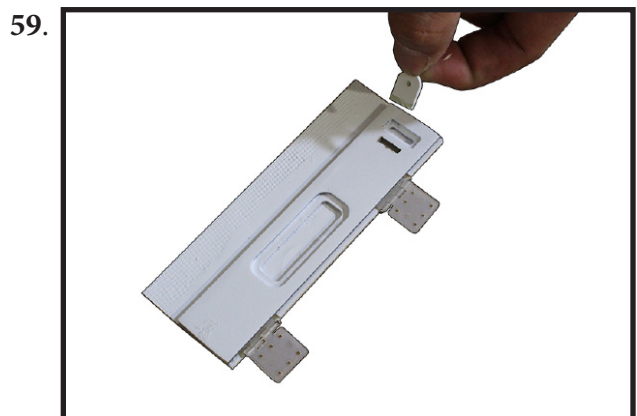
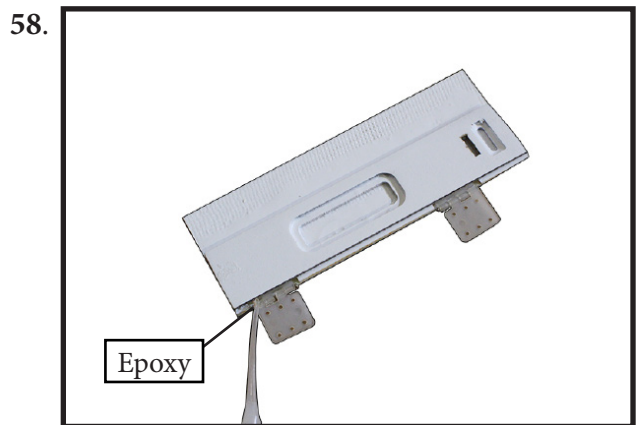
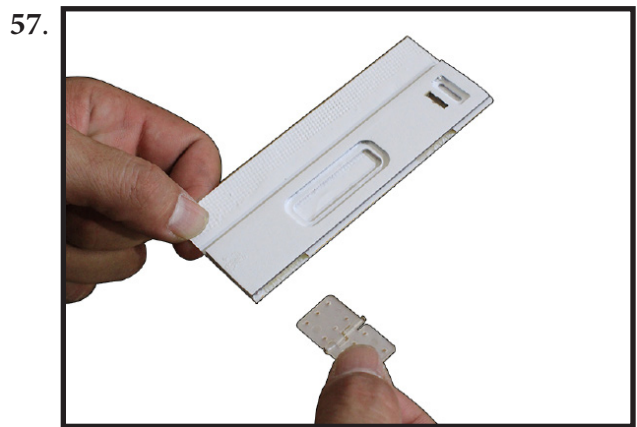
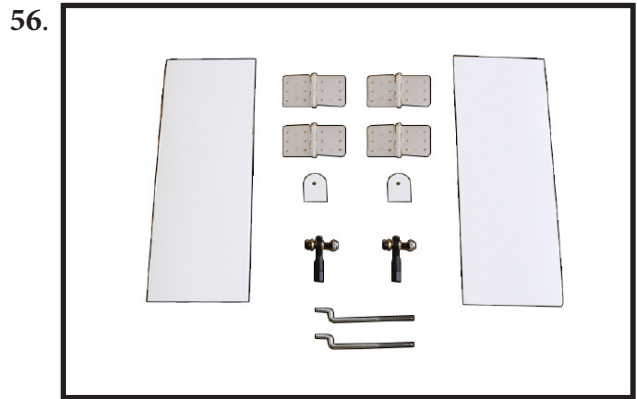

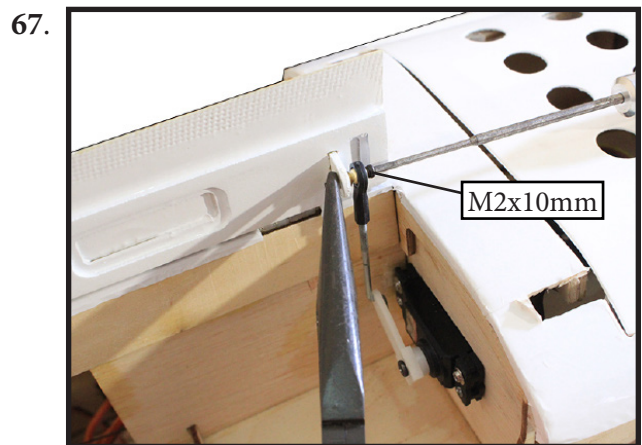
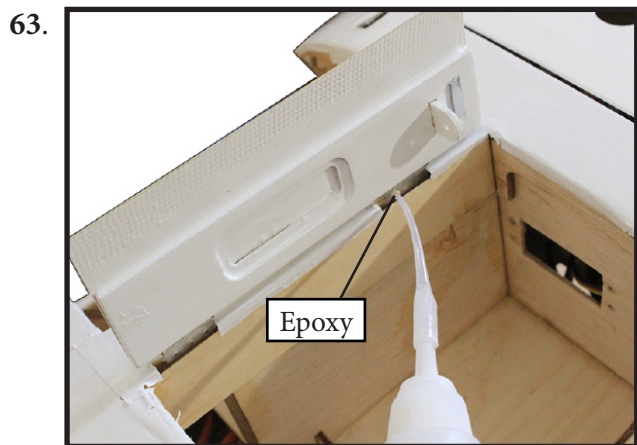
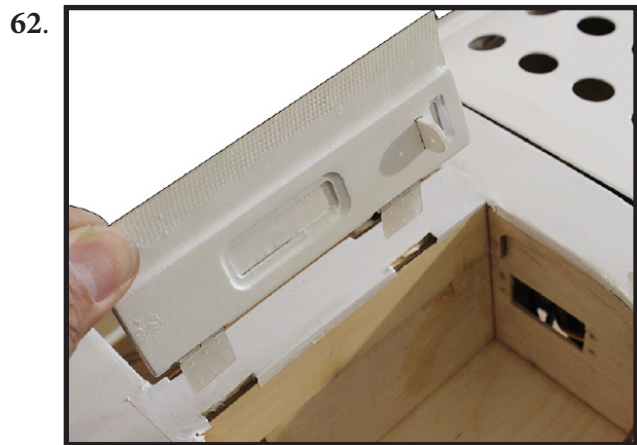
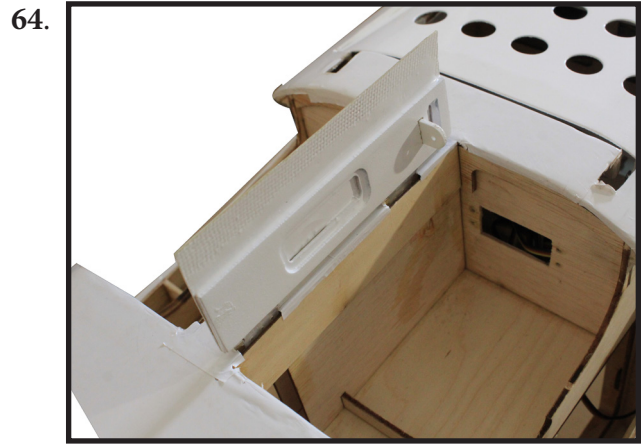
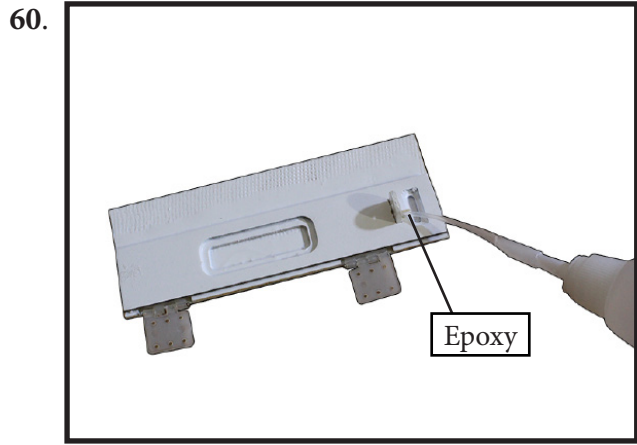



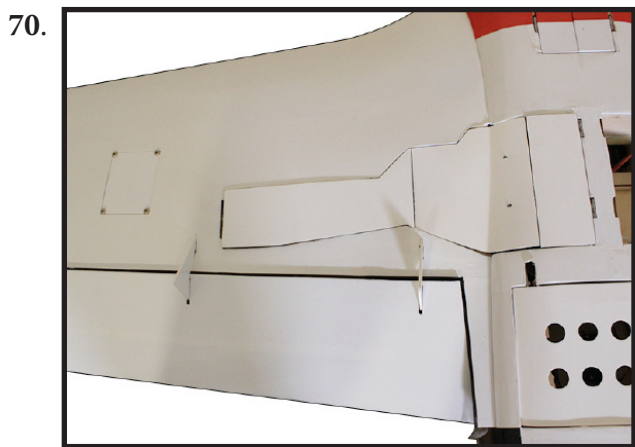
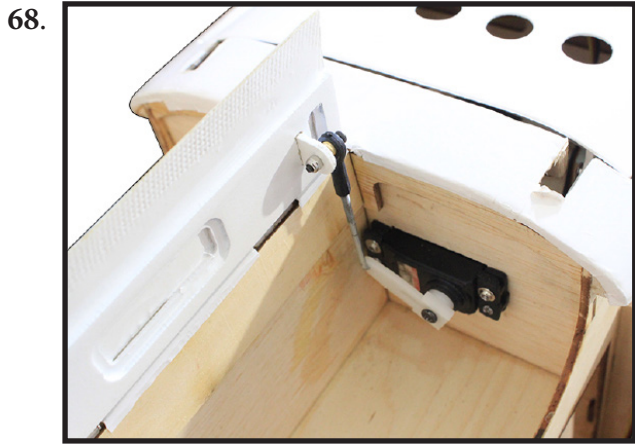

### INSTALLING THE FUSELAGE SERVOS

**!** Because the size of servos differ, you may need to adjust the size of the precut opening in the mount. The notch in the sides of the mount allow the servo lead to pass through.

Secure the servos with the screws provided with your servo.

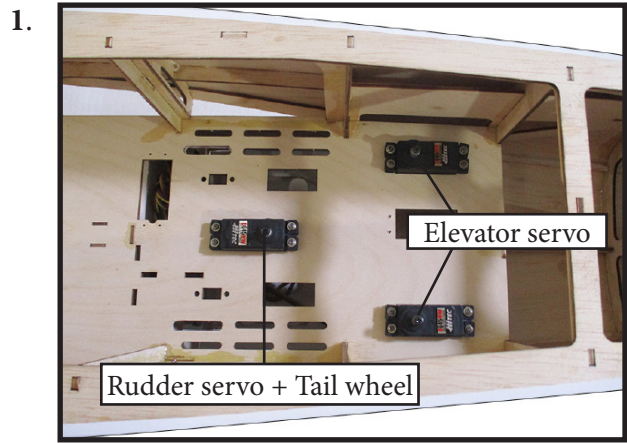

### THROTTLE SERVO ARM INSTALLATION

Install adjustable servo connector on the servo arm and set aside for now.

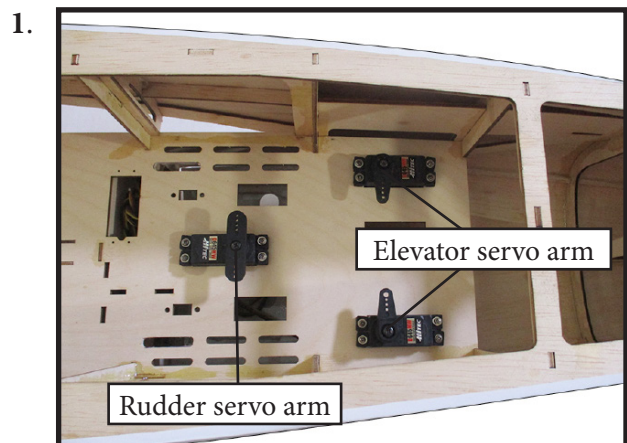

Install the rudder and elevator servo arms as shown above.

### INSTALLING THE RECEIVER SWITCH

Install the switch into the precut hole in the side of fuselage, or you may hide switches under main hatch on a custom home made switch plate as desired.

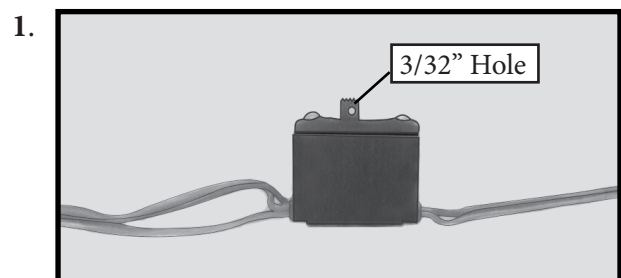

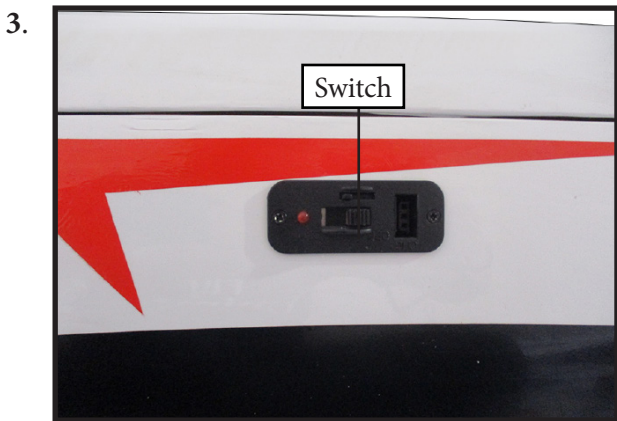
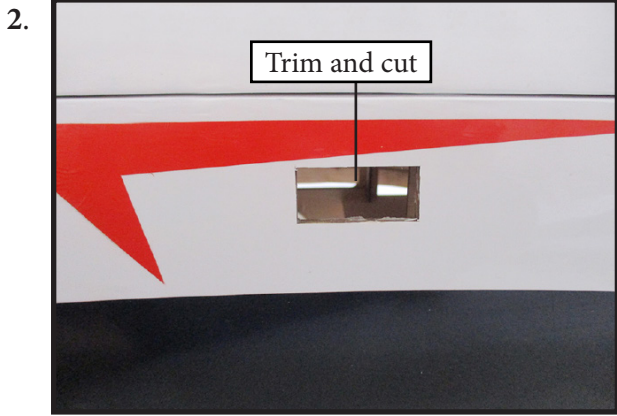

**INSTALLING THE ENGINE SWITCH**

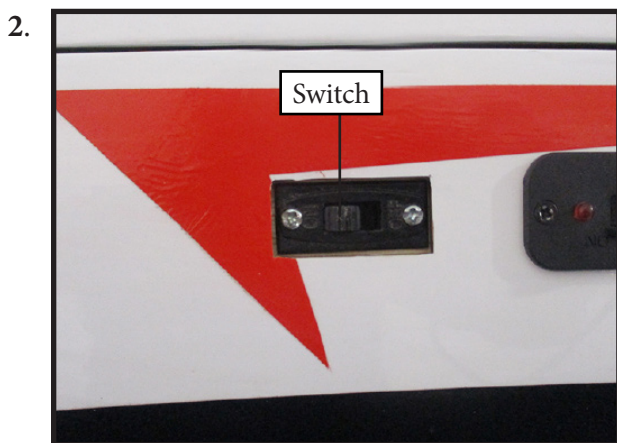
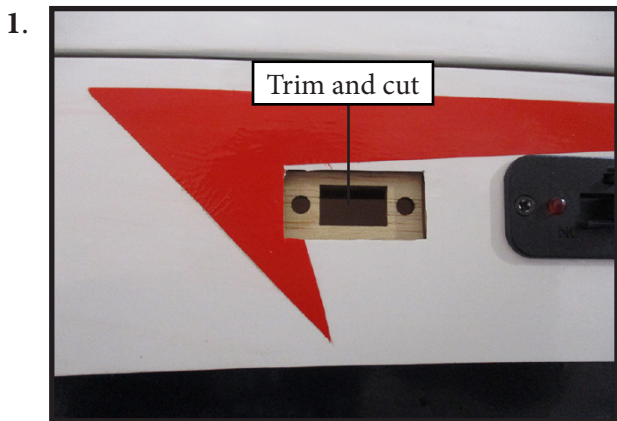

**ELECTRIC POWER CONVERSION**

Locate the items necessary to install the electric power conversion included with your model.

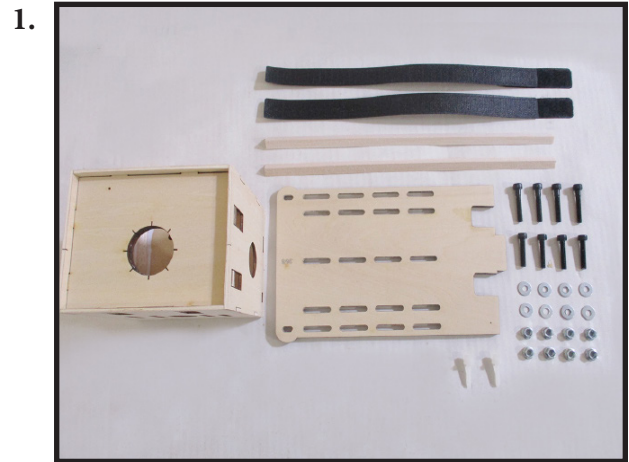

Recommend the items necessary to install the electric power conversion parts included with your model.

- **Motor: 360 - 6000 Watt**
- **Propeller: 24x10**
- **ESC: 160A- 200A**
- **Lipo: 12S**

Attach the electric motor box to the firewall centered with the cross lines drawn on the electric motor box and firewall. Using M5x30mm to secure the motor box to the firewall. Please see pictures below.

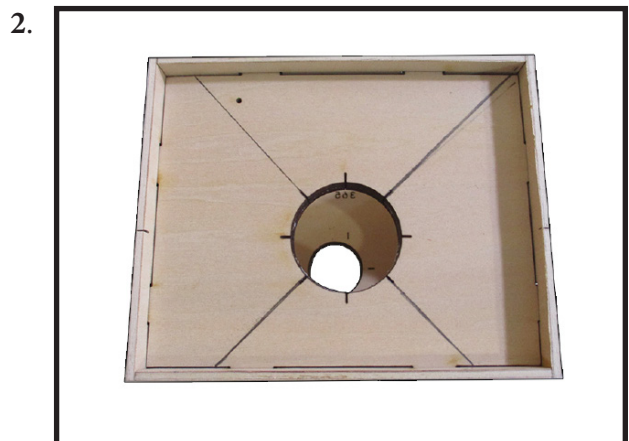



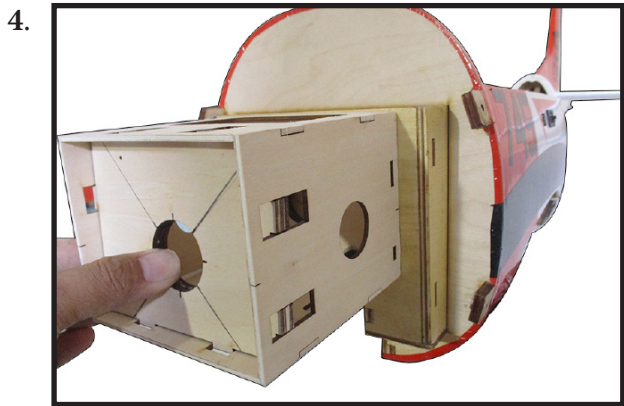
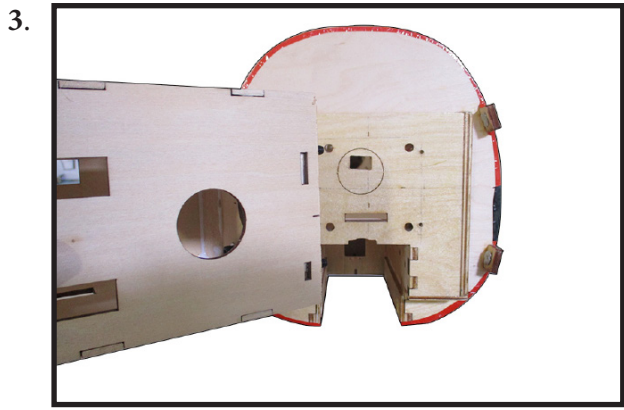

Attach the motor mount to the front of the electric motor box using four 5mm blind nut, four M5x30mm hex head bolts to secure the motor. Please see picture shown.

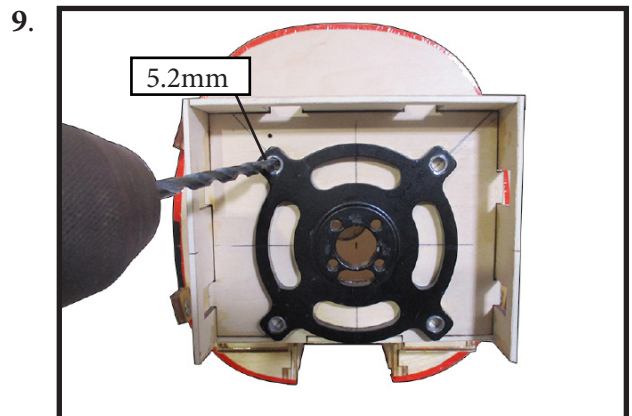
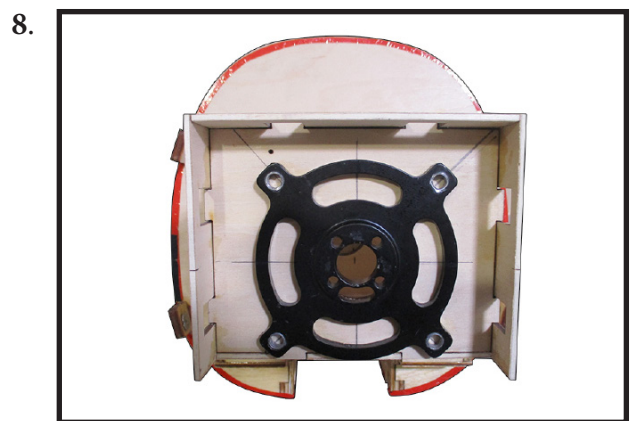

Then, use 5.2mm drill bit to enlarge the holes on the electric motor box.

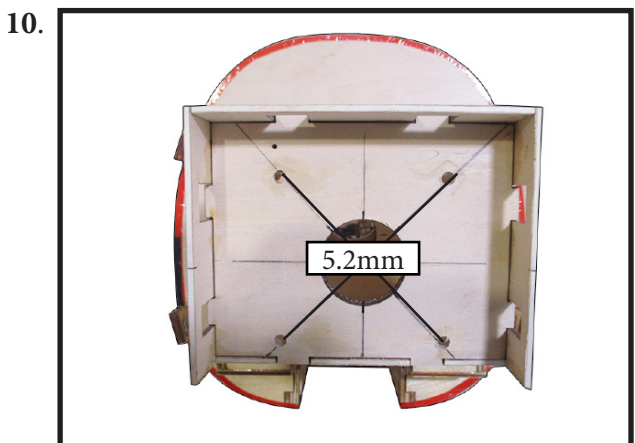

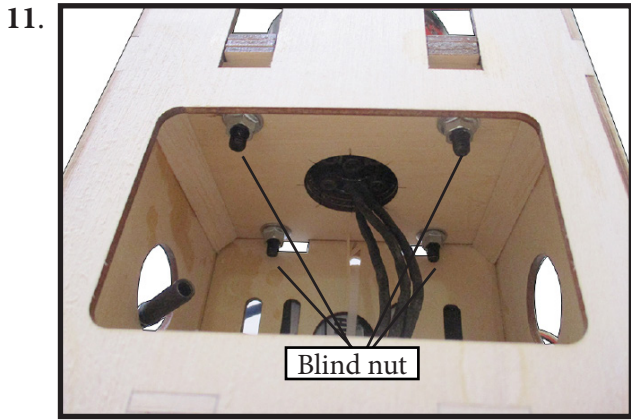

Attach the motor to the front of the electric motor box using four 4mm blind nut, four M5x25mm hex head bolts to secure the motor. Please see picture shown.

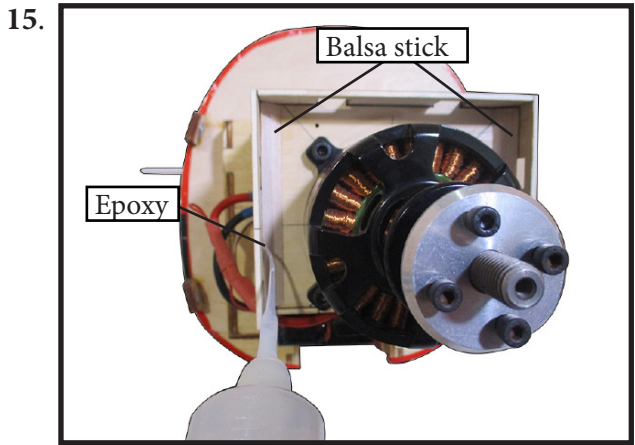
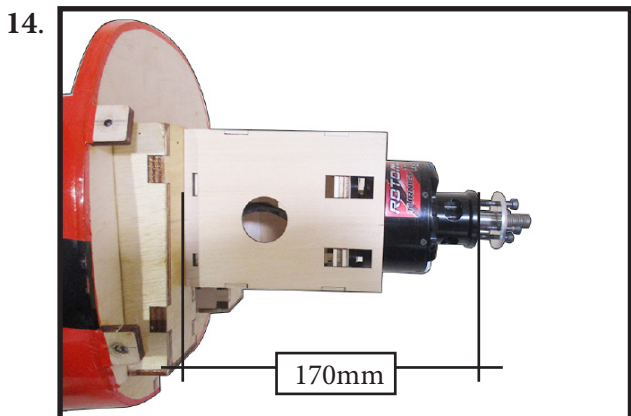
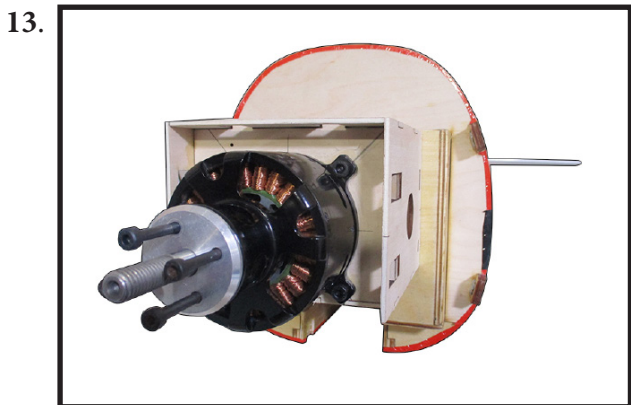
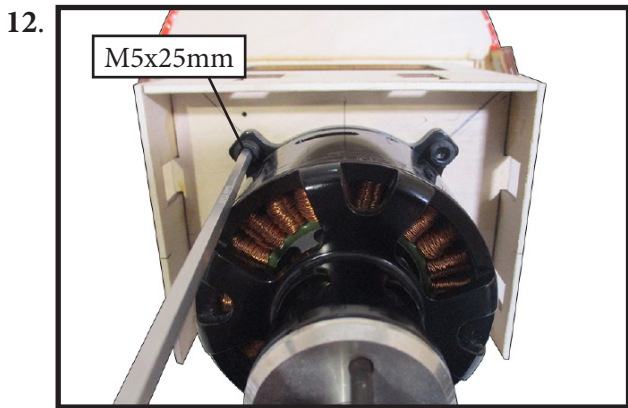

Attach the speed control to the side of the motor box using two-sided tape and tie wraps. Connect the appropriate leads from the speed control to the motor. Make sure the leads will not interfere with the operation of the motor.

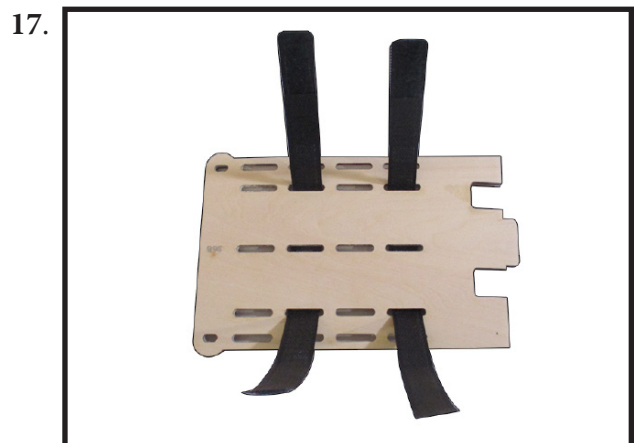
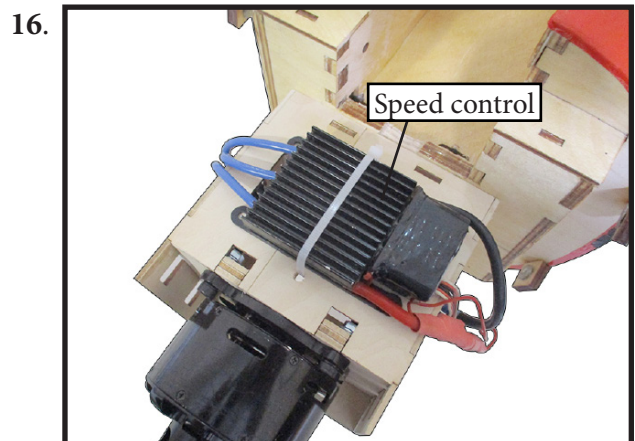



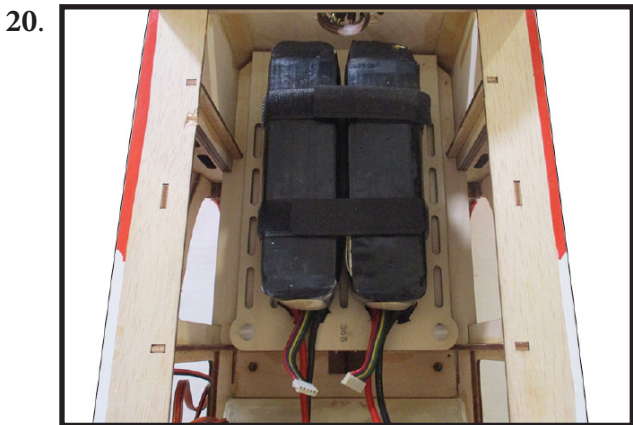
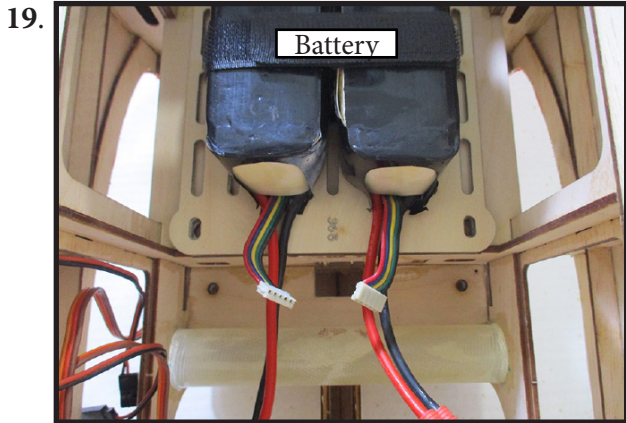
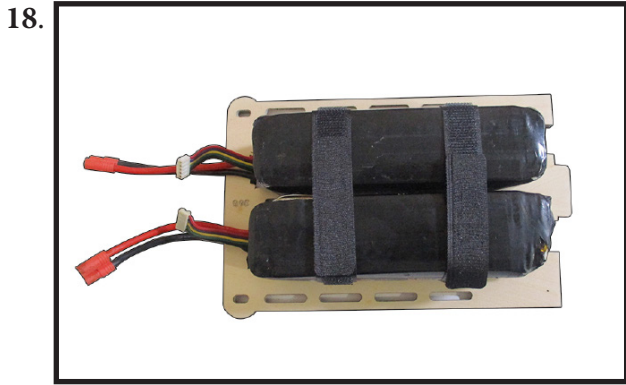

**COWLING & ENGINE BAFFLE**

Please study images below.

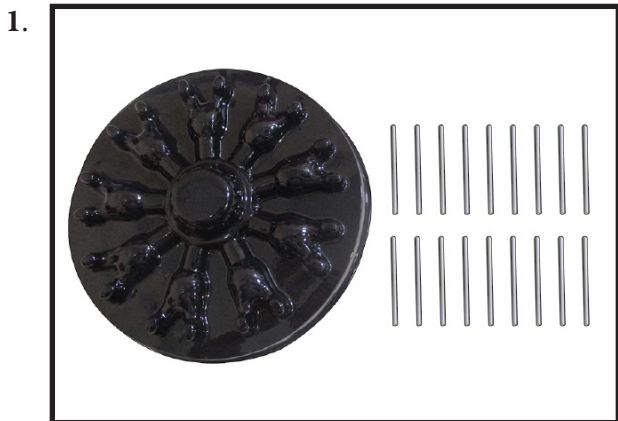

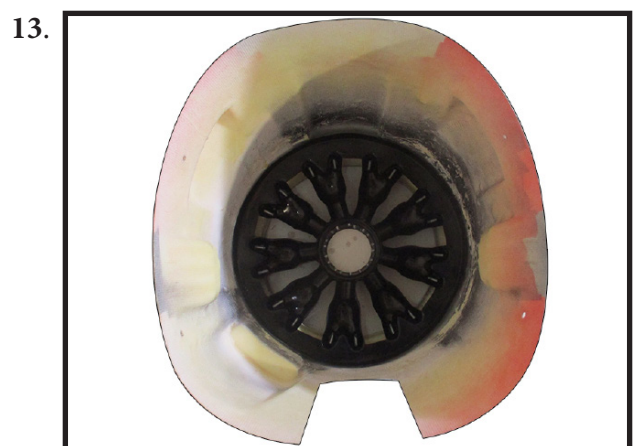
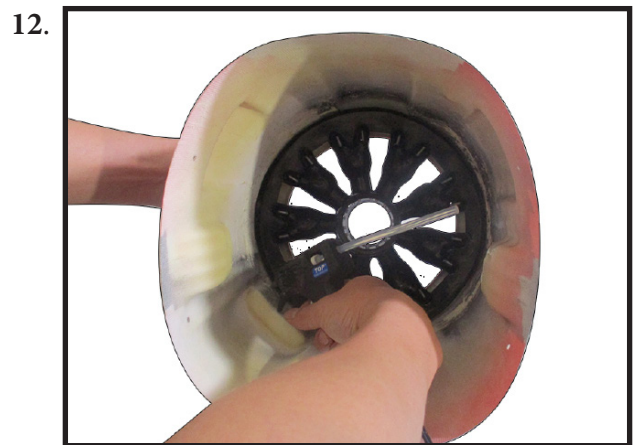
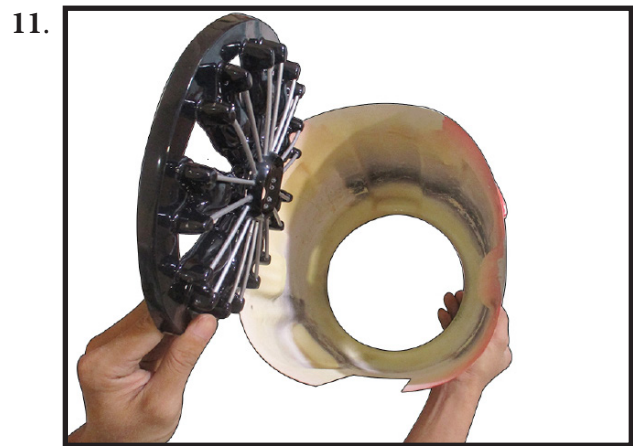





Tape the cowl to the fuselage using low-tack tape.

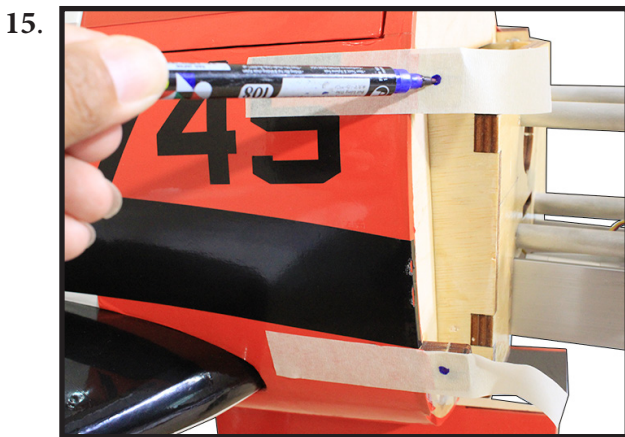

Use a drill and drill bit to drill the holes for the cowl mounting screws. Make sure the cowl position is correct before drilling each hole.

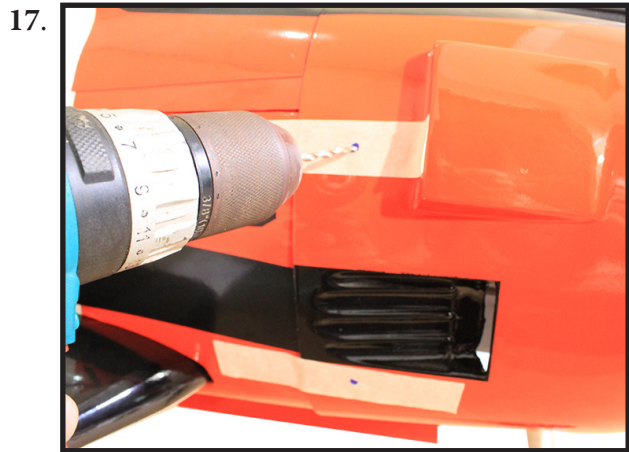

Install the muffler onto the engine and make the cutout in the cowl for muffler clearance. Connect the fuel and pressure lines to the carburetor, muffler and fuel filler valve. Secure the cowl to fuselage using the M3x10mm socket head screws. Putting a small length of silicone fuel tube under the head of the screw helps with vibration.

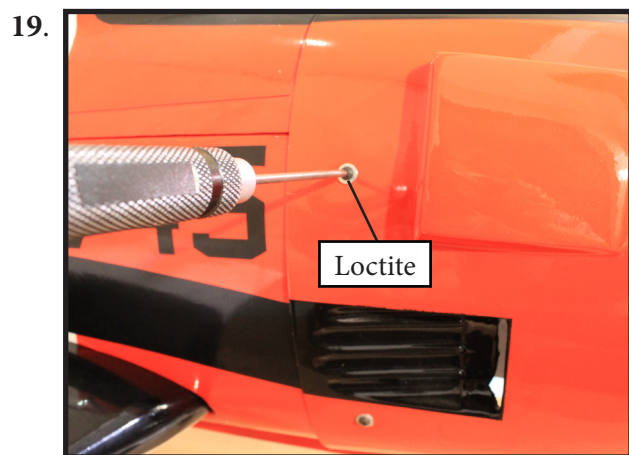
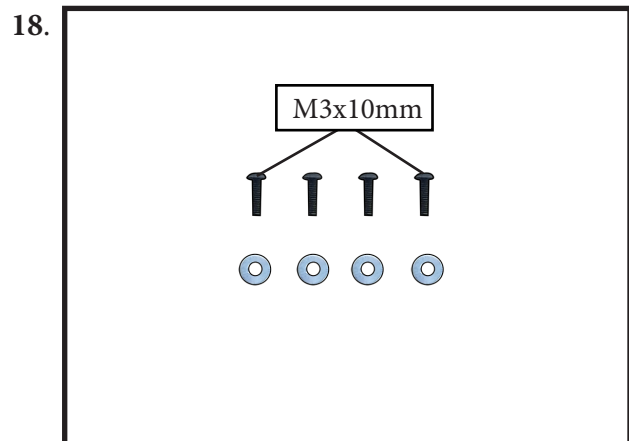





**ROBART NOSE GEAR  
INSTALLATION**

Locate the parts needed to attach the nose gear.

**INSTALLING THE SPINNER**

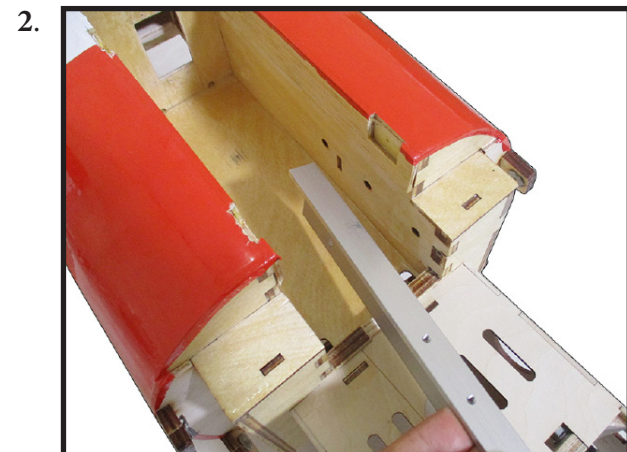
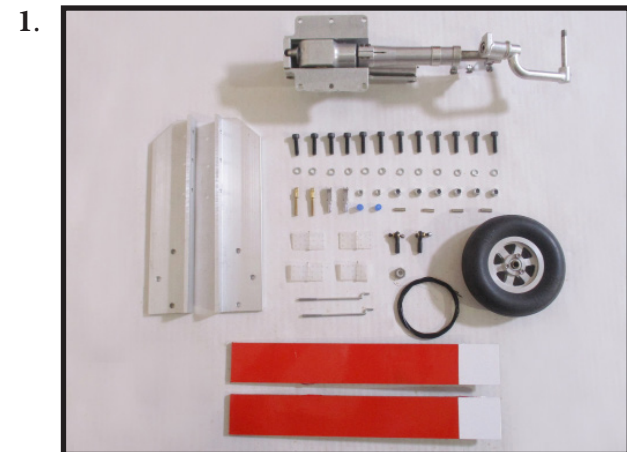
Install the spinner backplate, propeller and spinner cone.



 The propeller should not touch any part of the cowling. If it does, check and adjust engine mounting/cowl spacing as needed to where the propeller will not come in contact with the cowling.



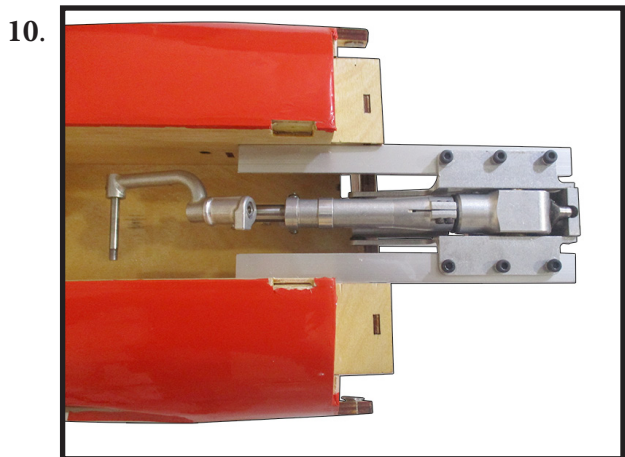
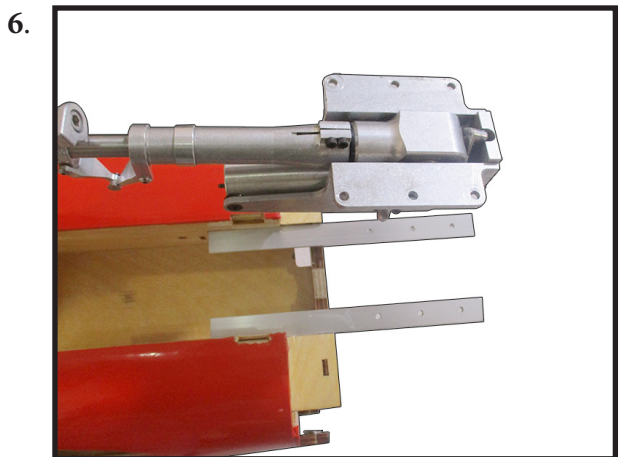
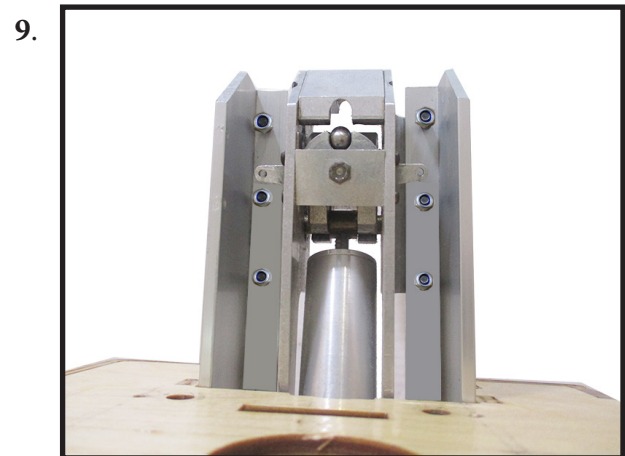
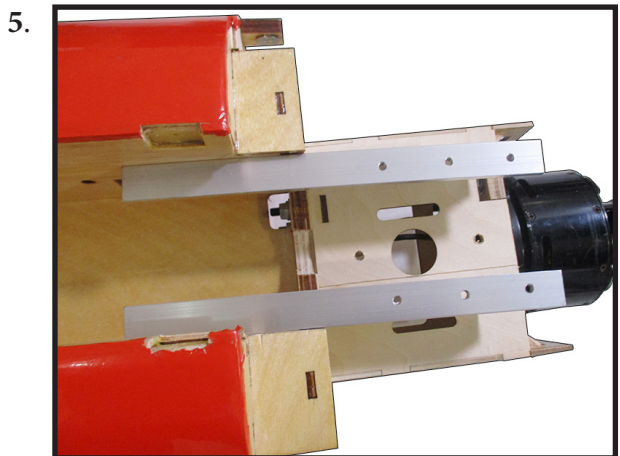
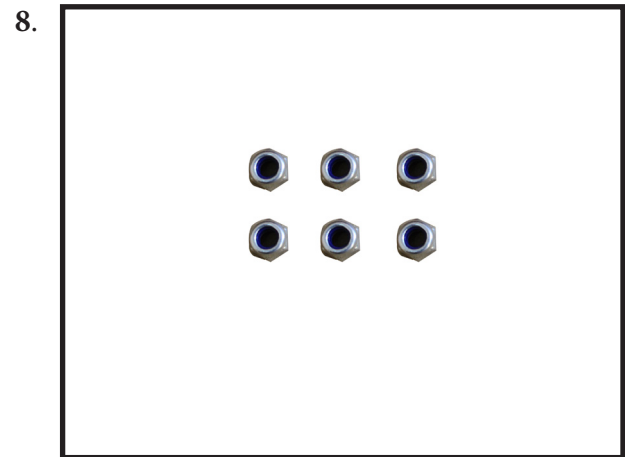
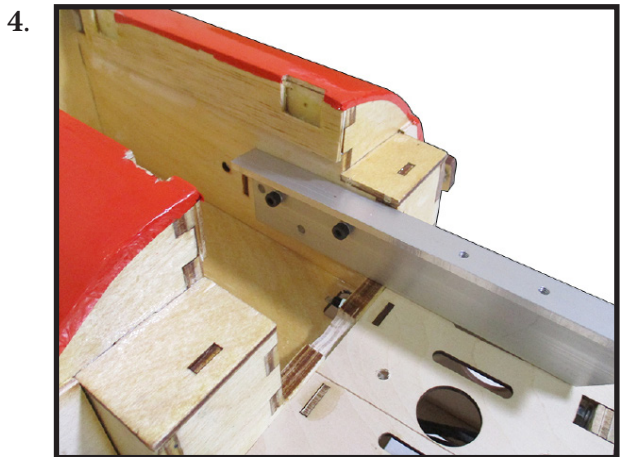
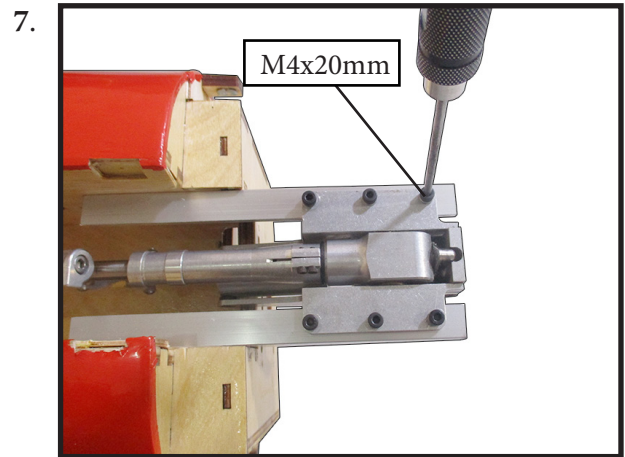
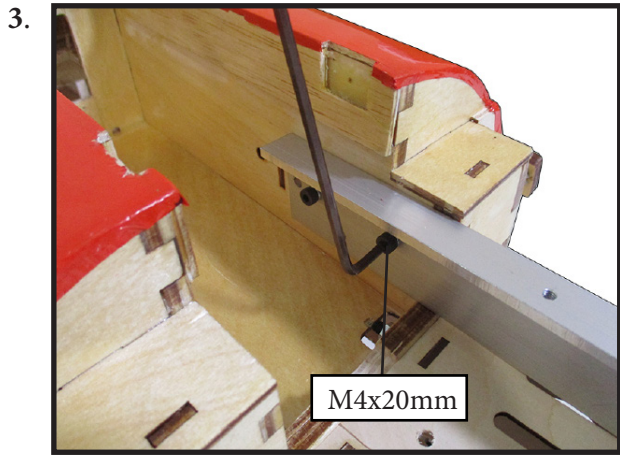

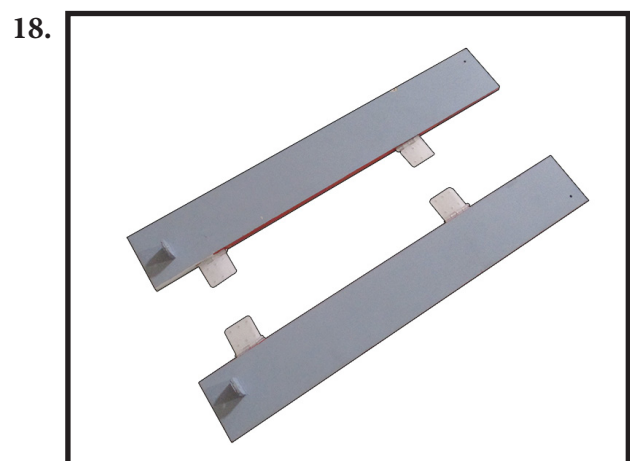
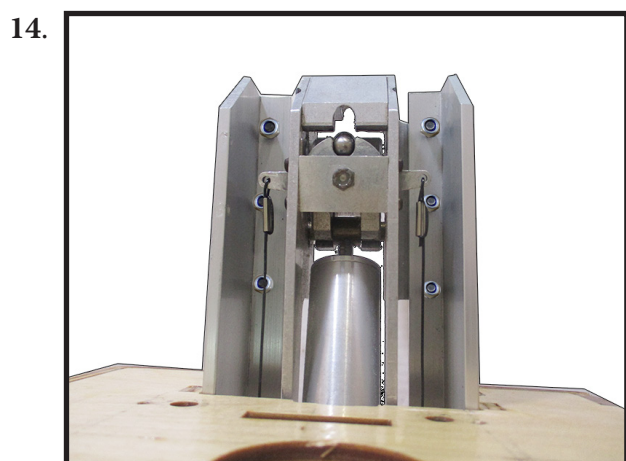
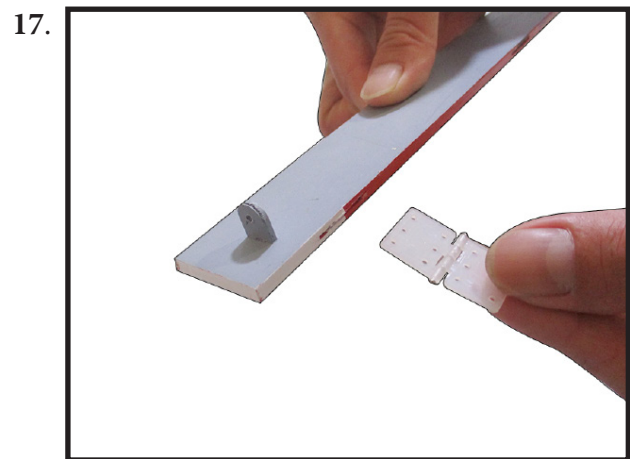
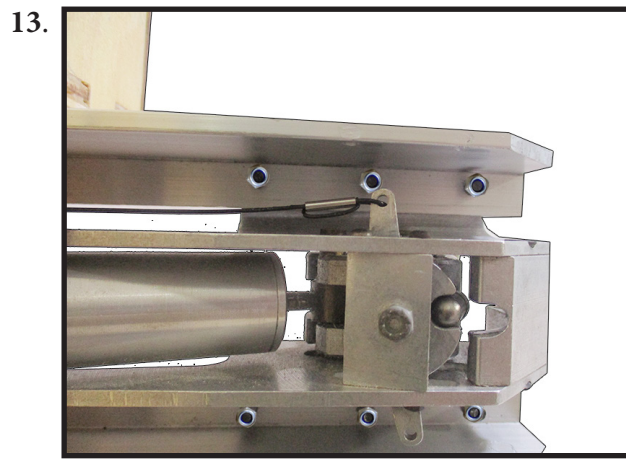
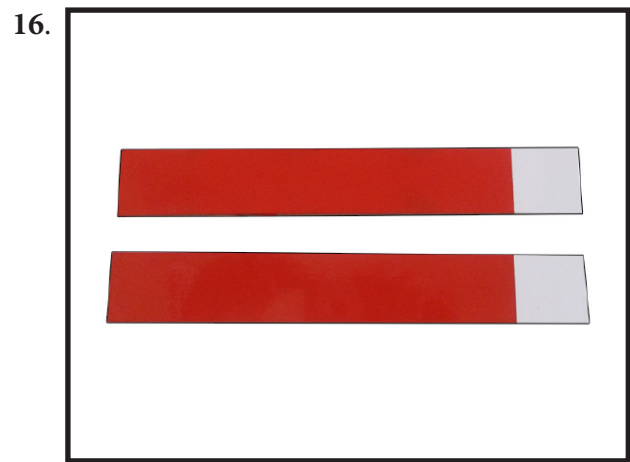
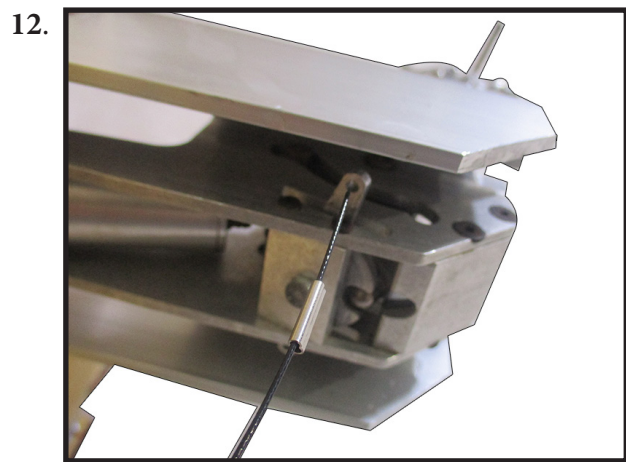
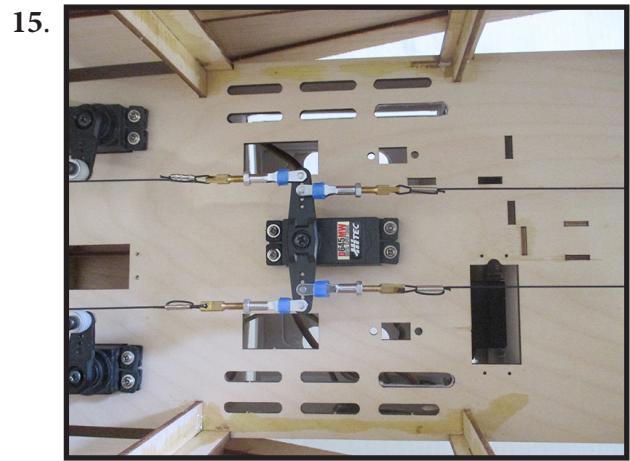
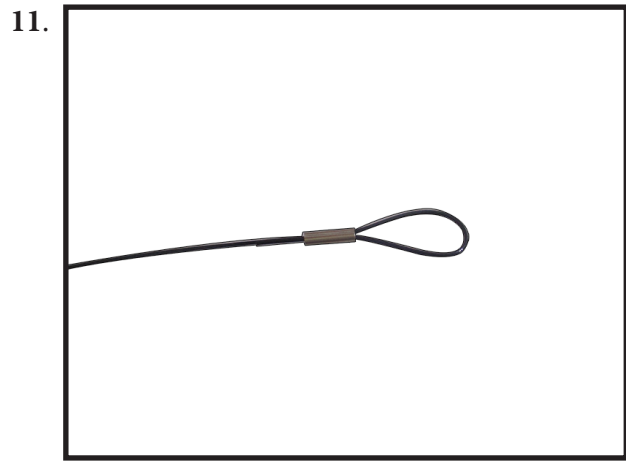



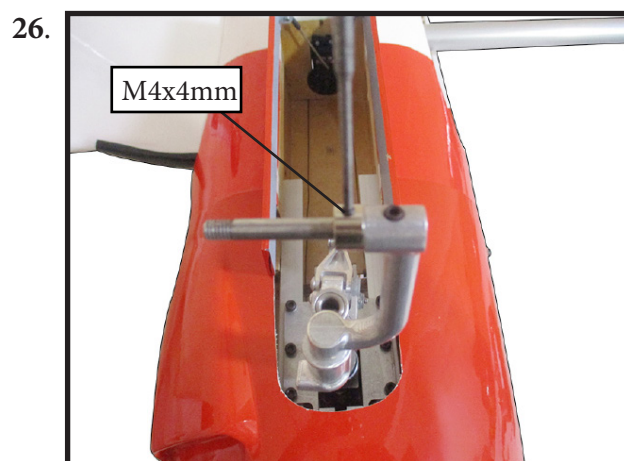
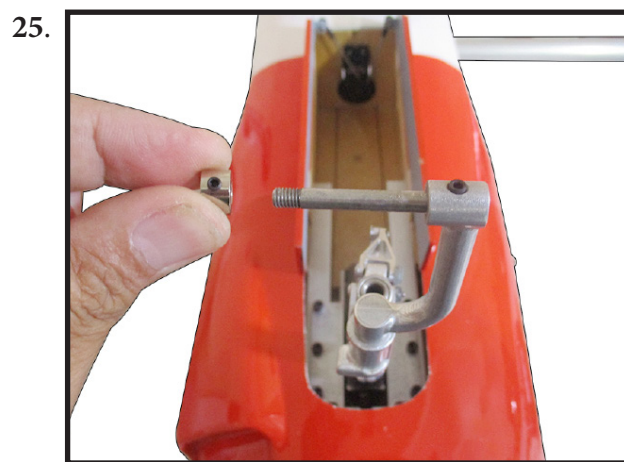
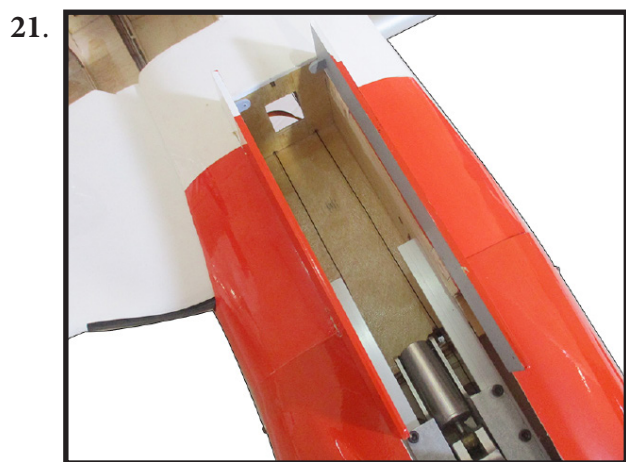
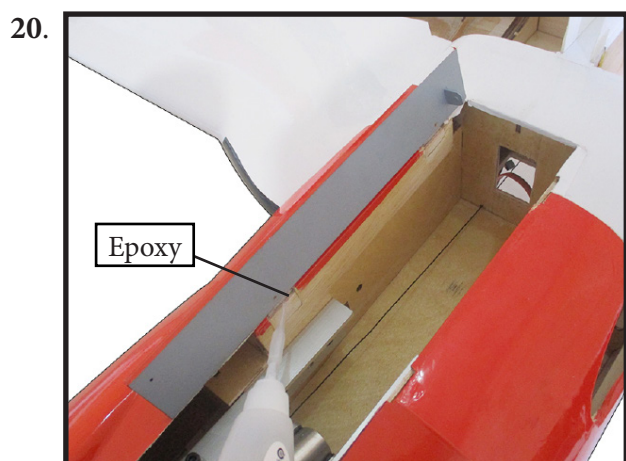
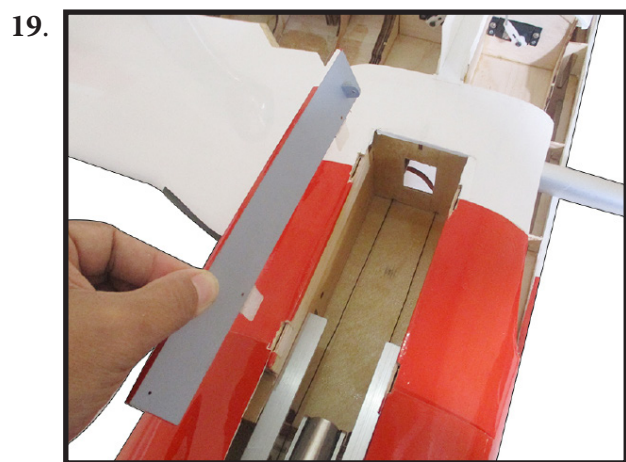

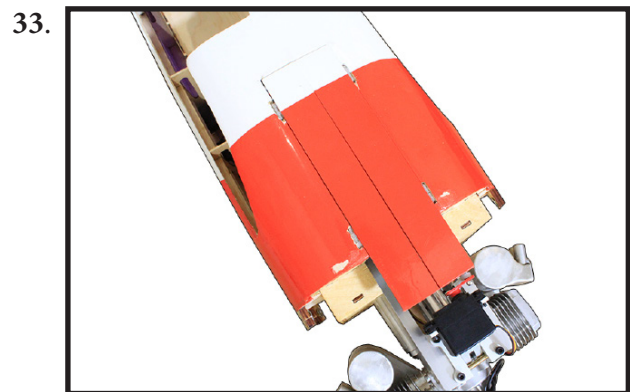
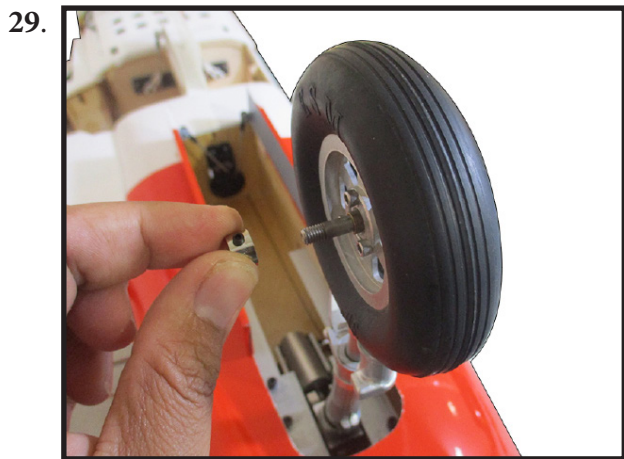
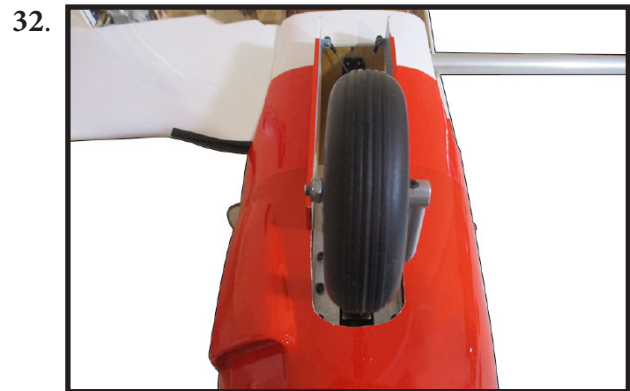
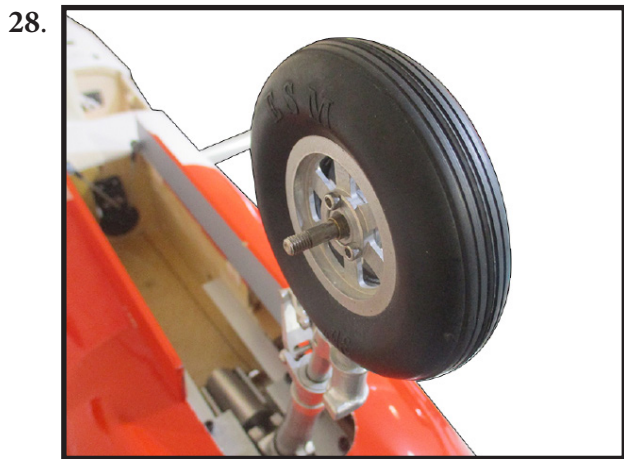
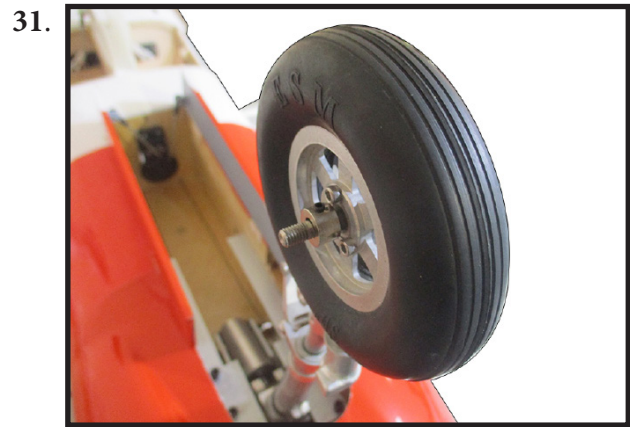
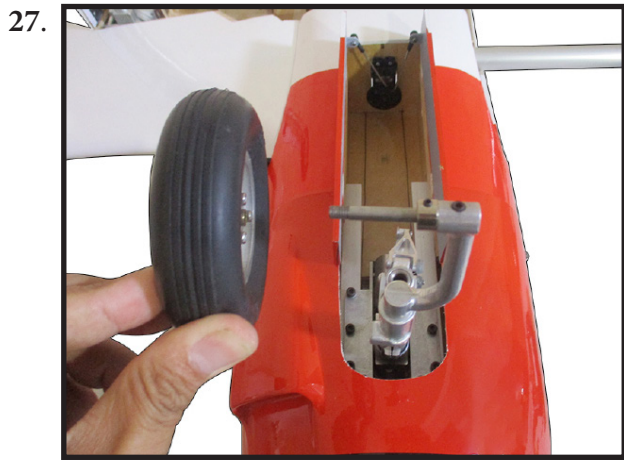

**RETRACTABLE NOSE GEAR  
INSTALLATION**

Locate the parts needed to attach the nose gear.

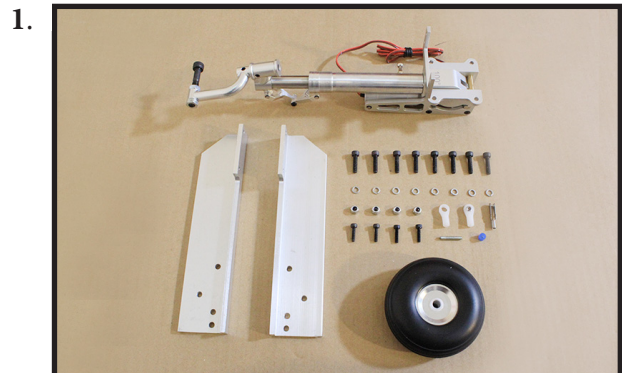
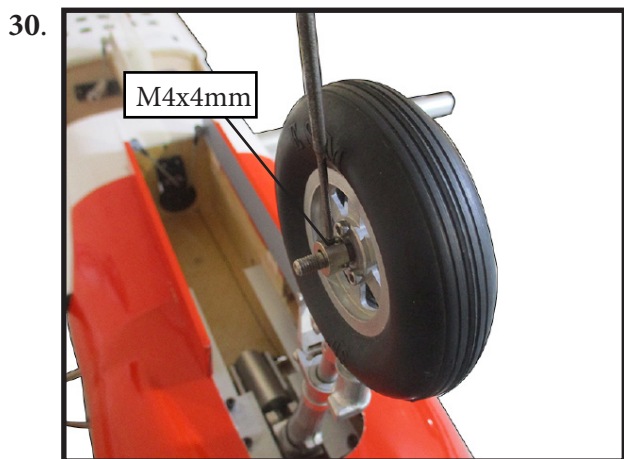



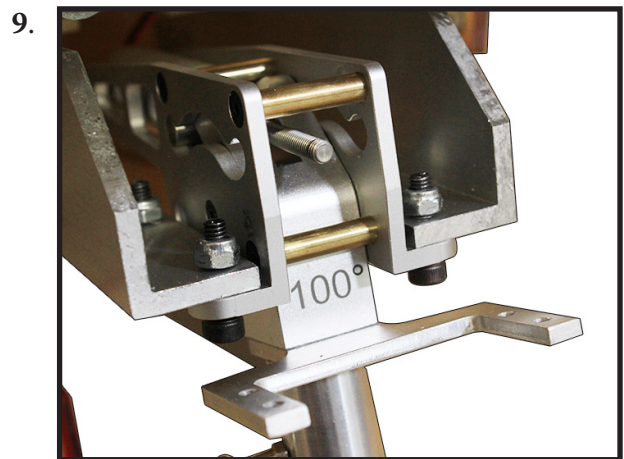
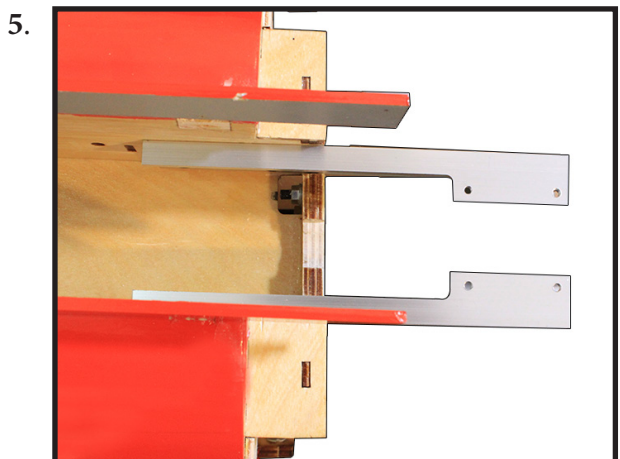
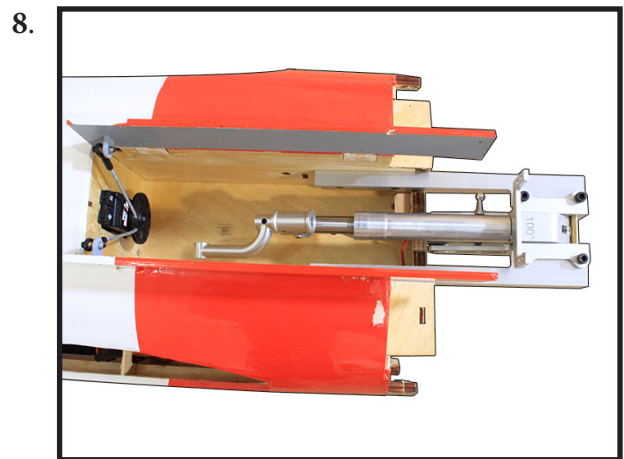
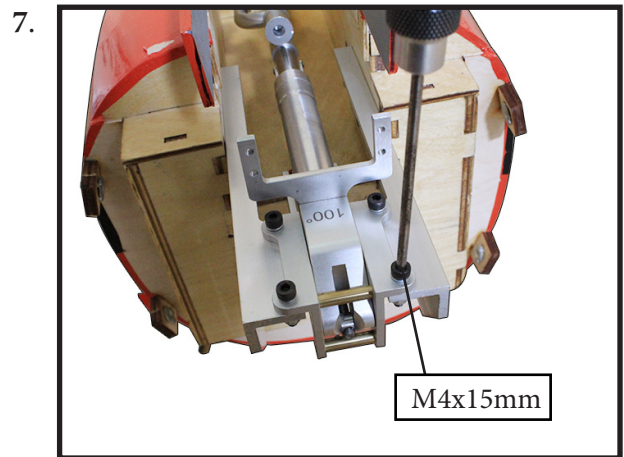
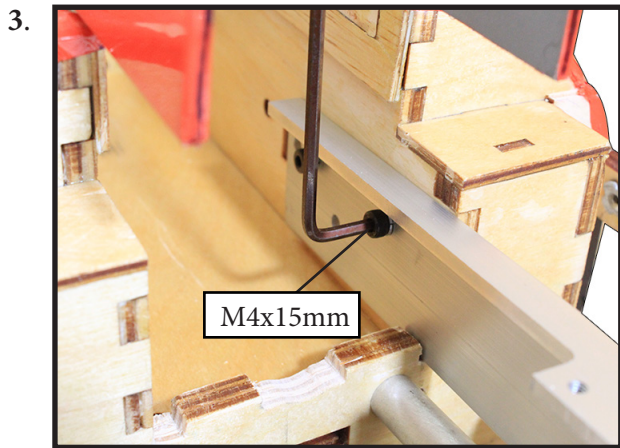
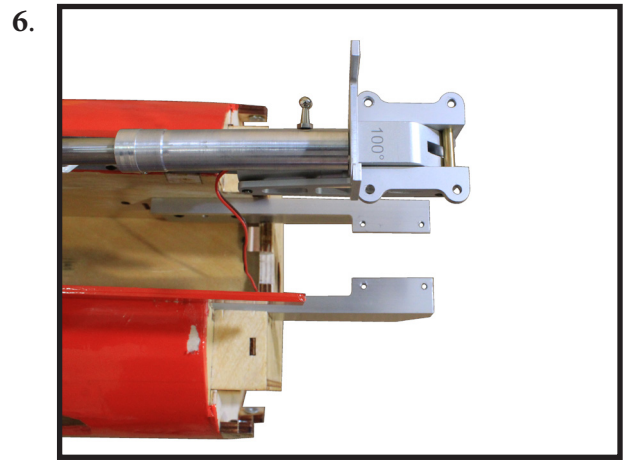
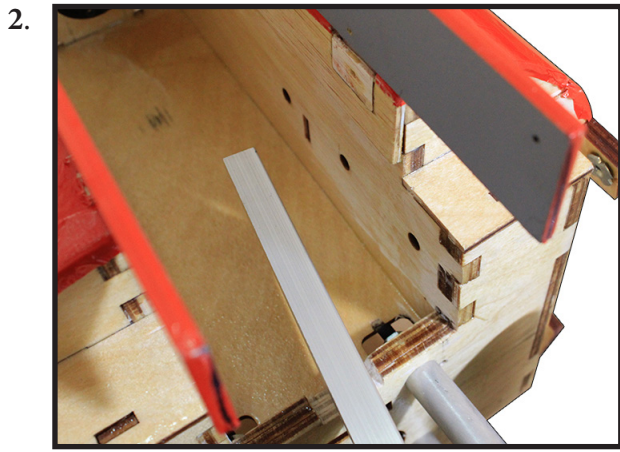

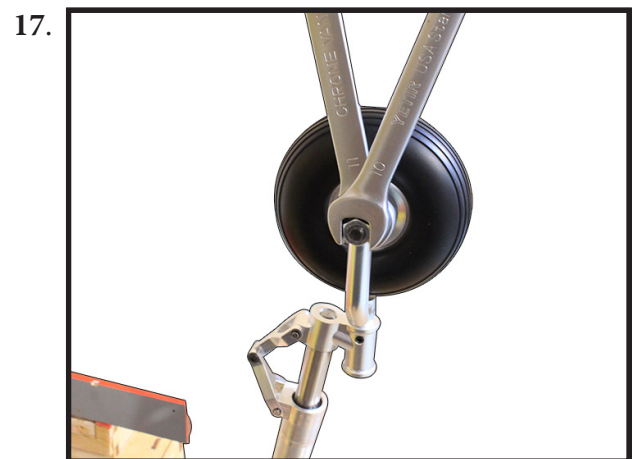
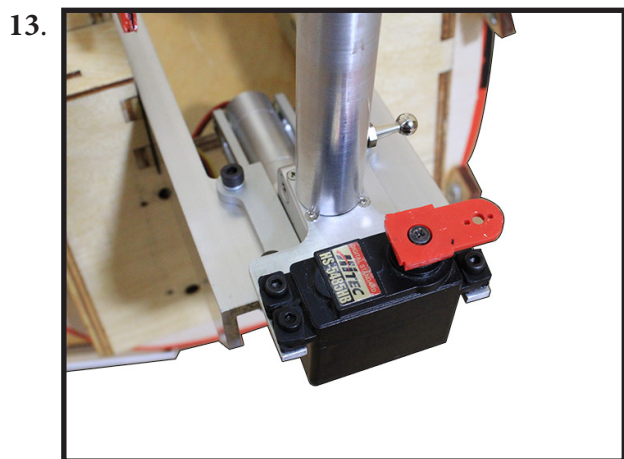
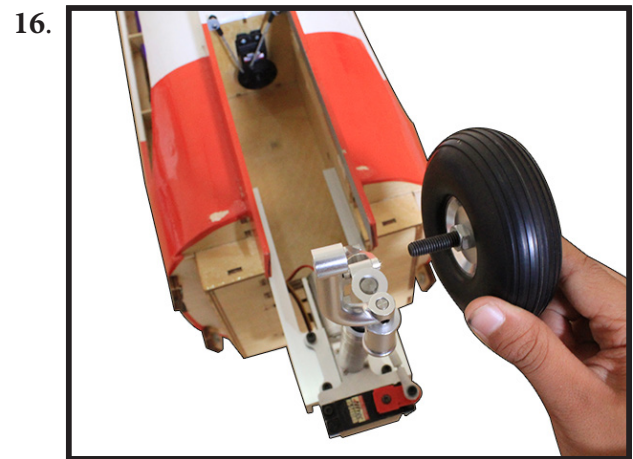
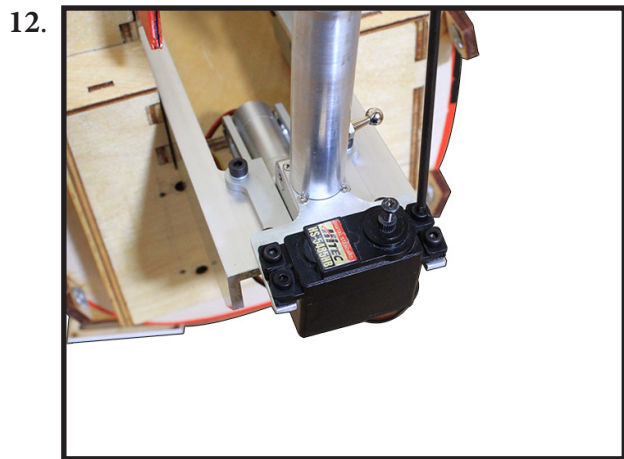
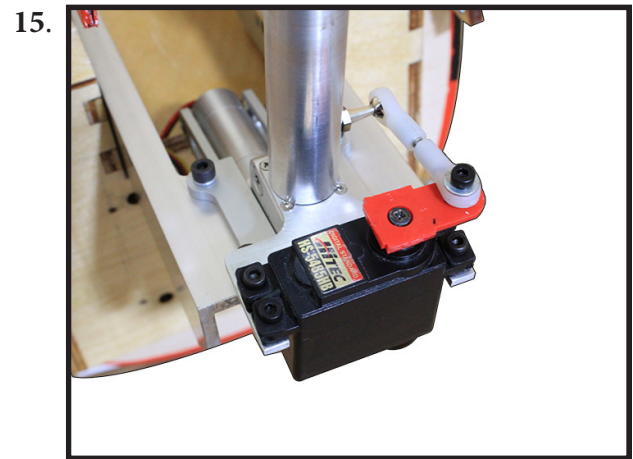
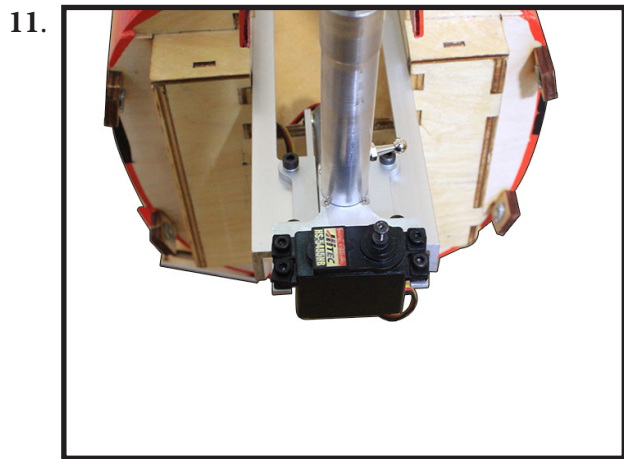
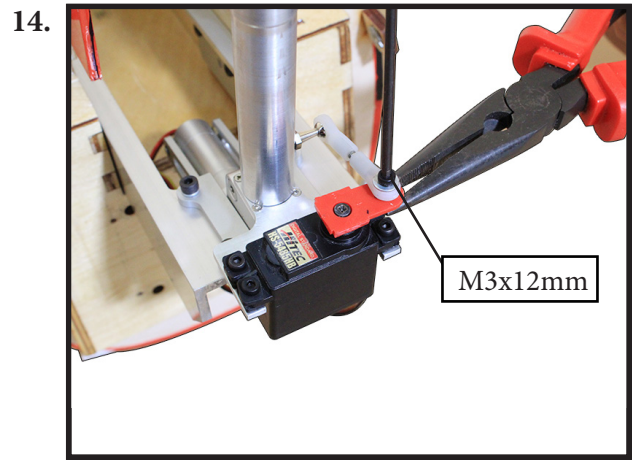
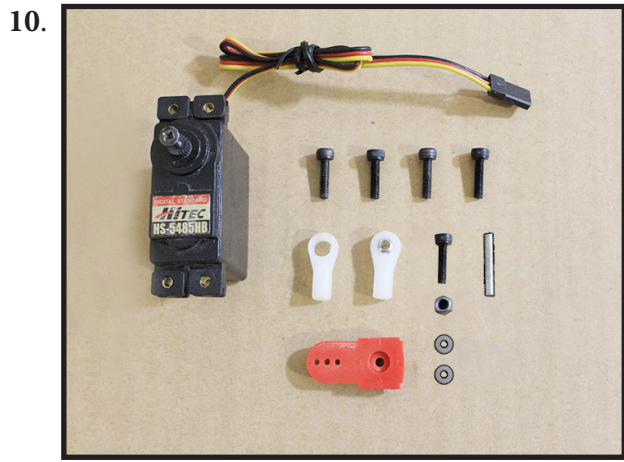



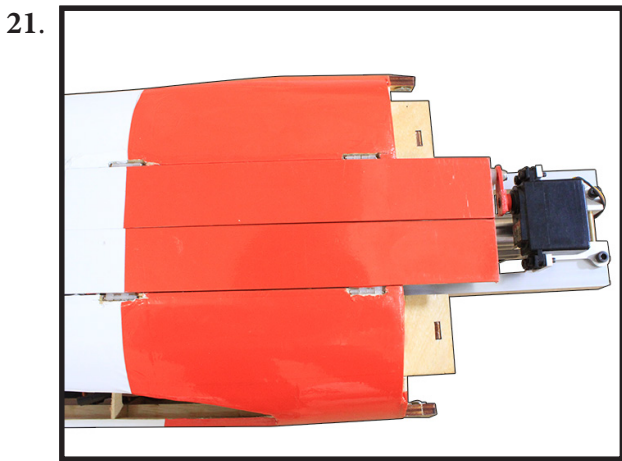
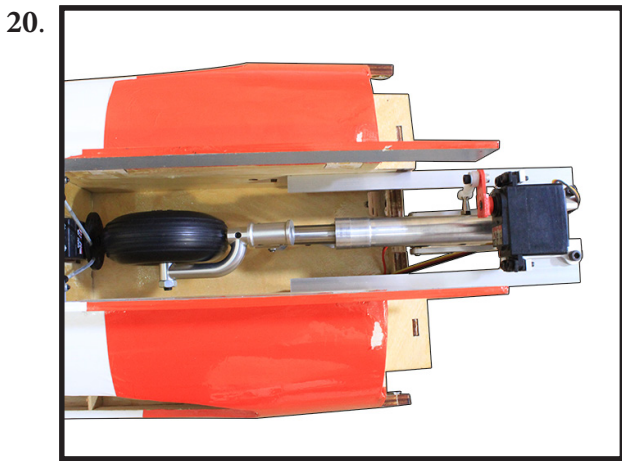
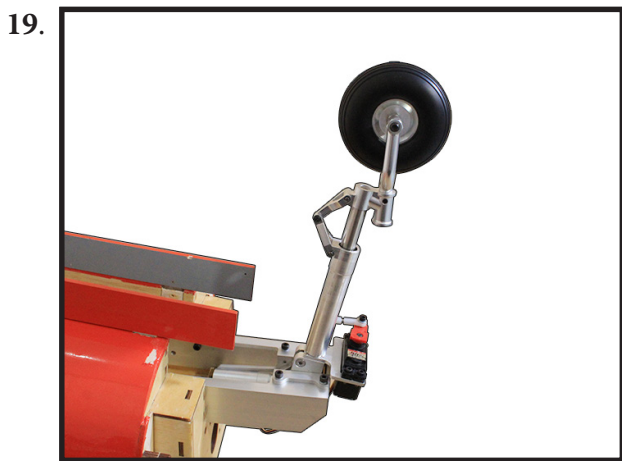
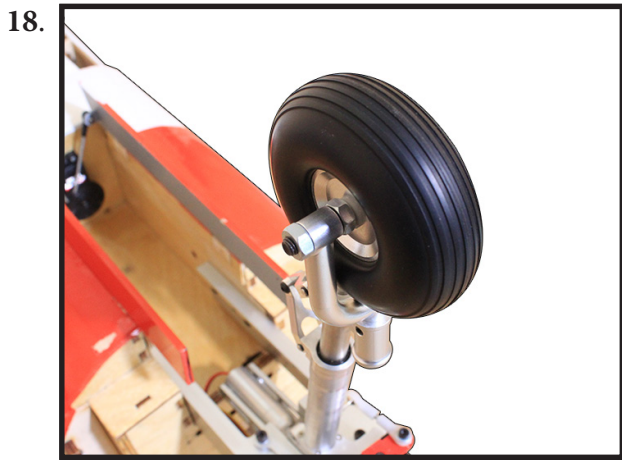

## HINGING THE ELEVATORS

Glue the elevator hinges in place using the same techniques used to hinge the ailerons.

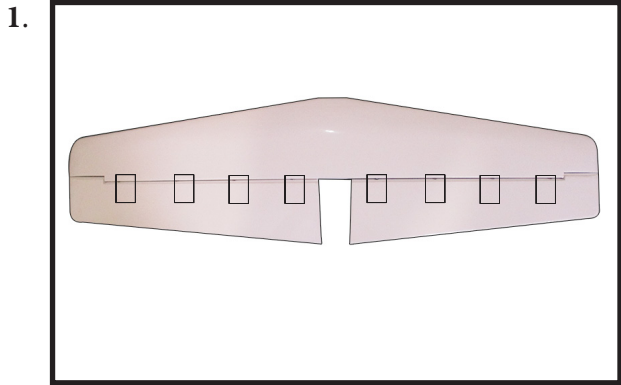

## INSTALL ELEVATOR CONTROL HORN

Install the elevator control horn using the same method as same as the flap control horns.

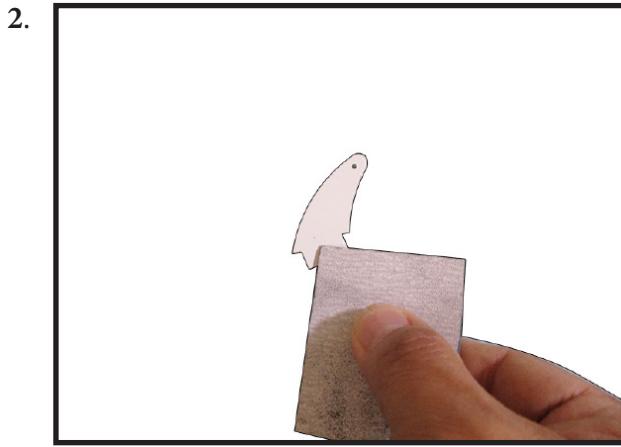
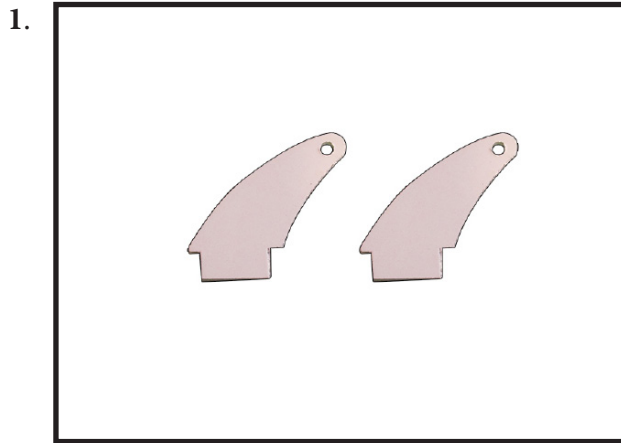

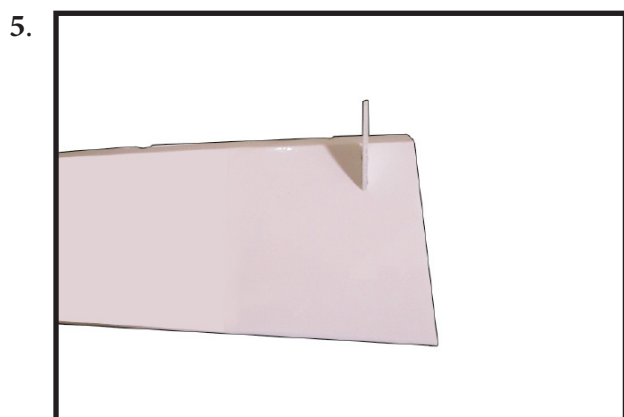
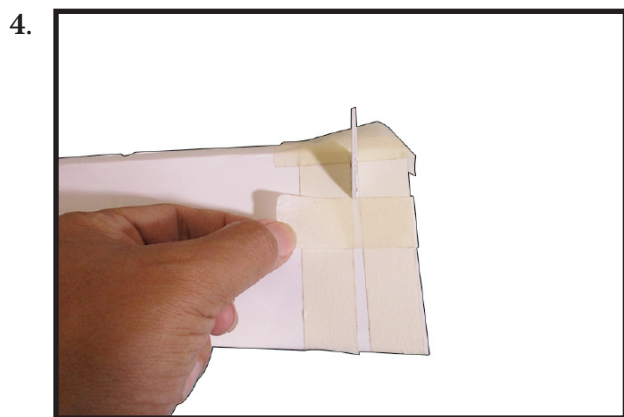
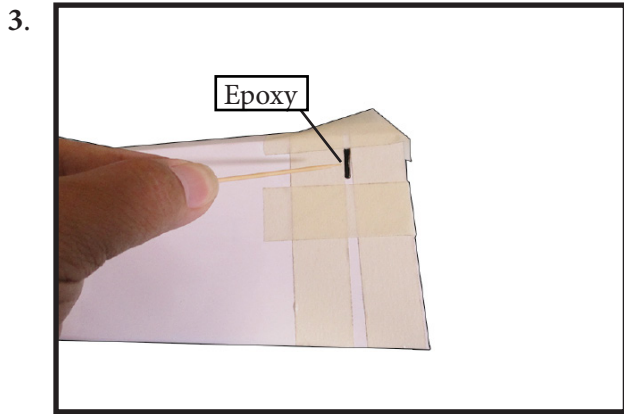

### ELEVATOR AND STABILIZER INSTALLATION

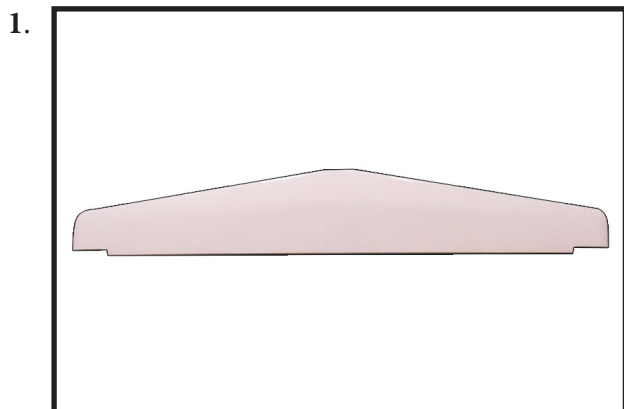

With the stabilizer held firmly in place, use a pen and draw lines onto the stabilizer where it and the fuselage sides meet. Do this on both the right and left sides and top and bottom of the stabilizer.

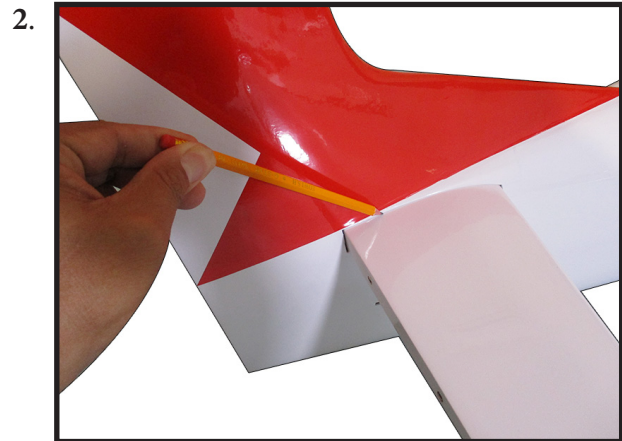

Remove the stabilizer. Using the lines you just drew as a guide, carefully remove the covering from between them using a modeling knife.

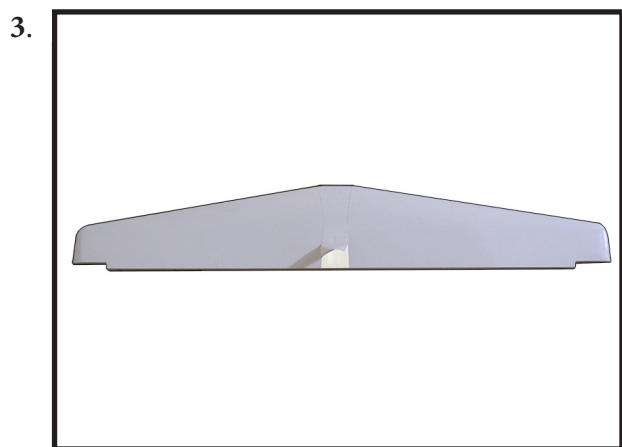

 *When cutting through the covering to remove it, cut with only enough pressure to only cut through the covering itself. Cutting into the balsa structure may weaken it.*

Using a modeling knife, carefully remove the covering that overlaps the stabilizer mounting platform sides in the fuselage. Remove the covering from both the top and the bottom of the platform sides.



4.

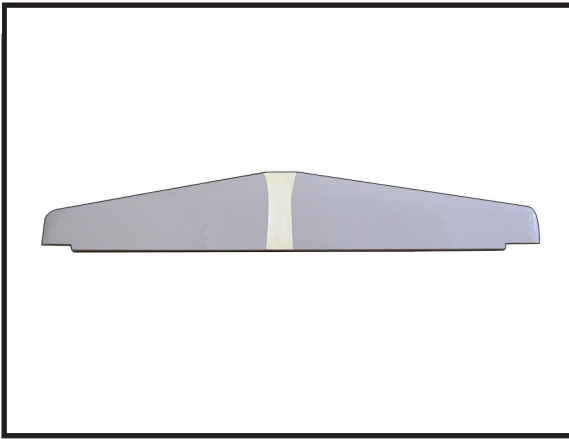

Slide the stabilizer partially into the fuselage so the wood at the center is exposed. Mix 1/2 ounce (15ml) of 30-minute epoxy. Use an epoxy brush to apply the epoxy to the exposed wood on the top of the stabilizer.

5.



6.

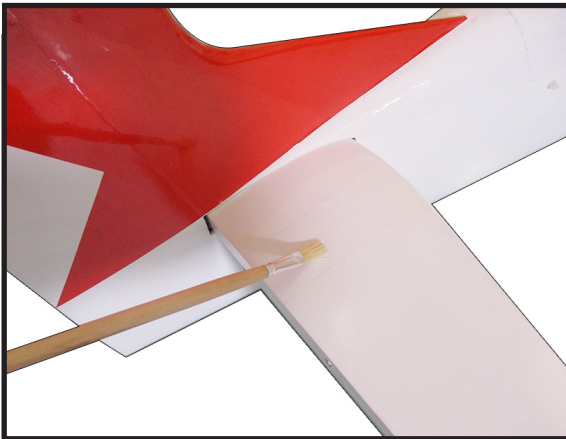

Carefully turn the model over and apply epoxy to the exposed wood on the bottom of the stabilizer. Slide the stabilizer back into position.

Use care not to get epoxy on the elevator joiner wire.

7.

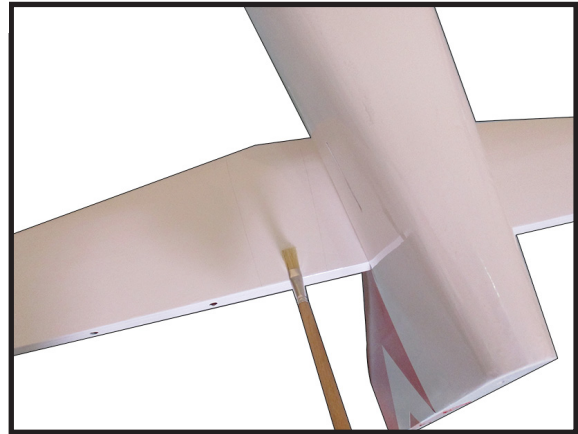

Once the alignment of the stabilizer has been verified, use a paper towel and isopropyl alcohol to remove any excess epoxy from the fuselage and stabilizer. Allow the epoxy to fully cure before proceeding.

If you find epoxy on the joiner wire, use the paper towel and isopropyl alcohol to clean the joiner.

8.

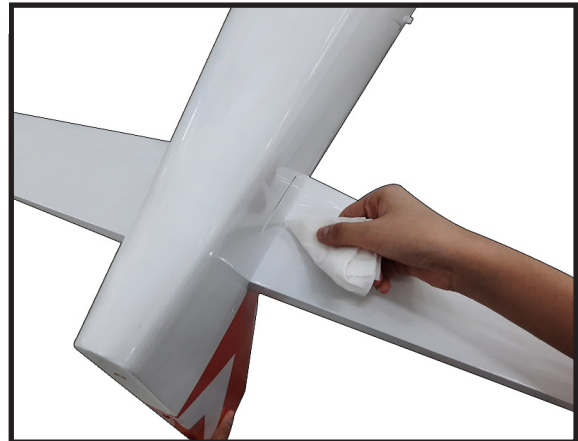

Use a pin vise and 1/16-inch (1.5mm) drill bit to drill a hole in the center of each hinge slot to allow the CA to wick into the hinge. Drill holes in both the elevators and stabilizer surfaces at this time. Place a T-pin in the center of each hinge along side the slot in the hinge. This will help center the hinge when it is placed in the elevators. Slide the hinges into position with the T-pin resting against the edge of the control surface.

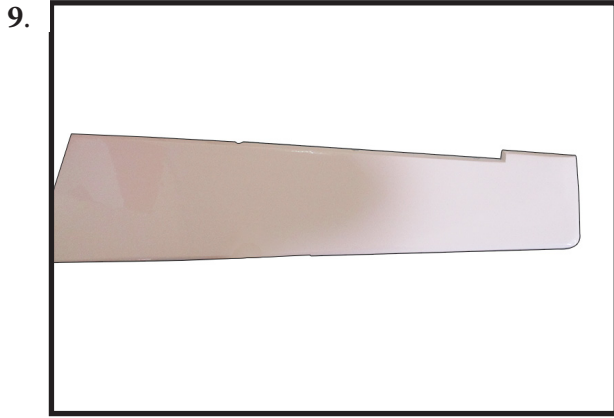

Fit the elevator into position on the stabilizer. Guide the joiner wire and hinges into position.

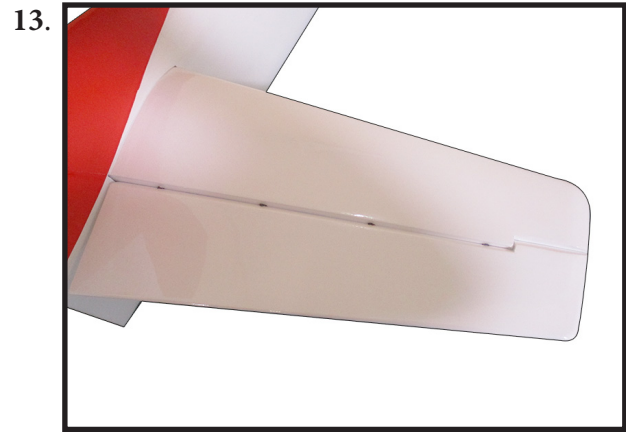
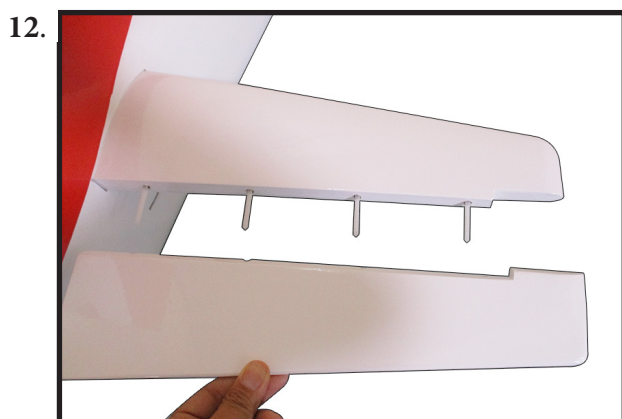
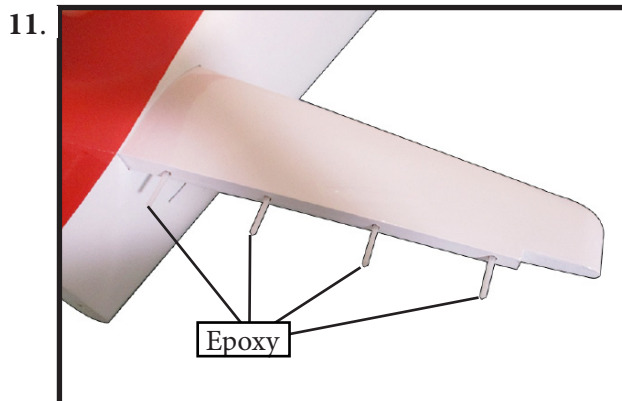
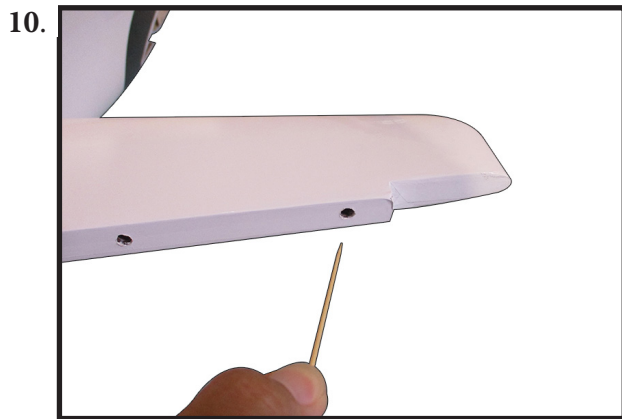

Fit the elevator so the leading edge fits tightly against the trailing edge of the stabilizer.

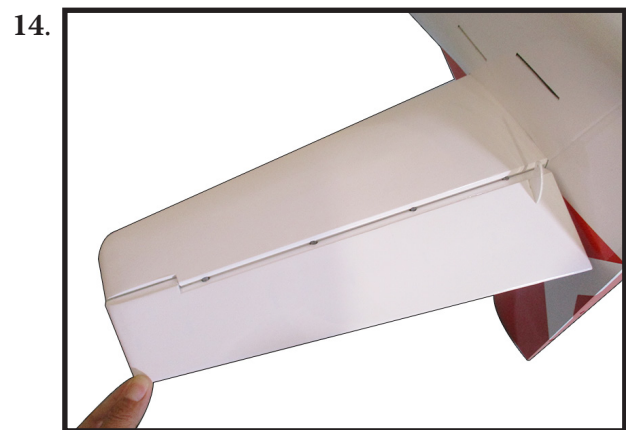

Check the fit of both elevators at this time. Once checked, remove the elevators.

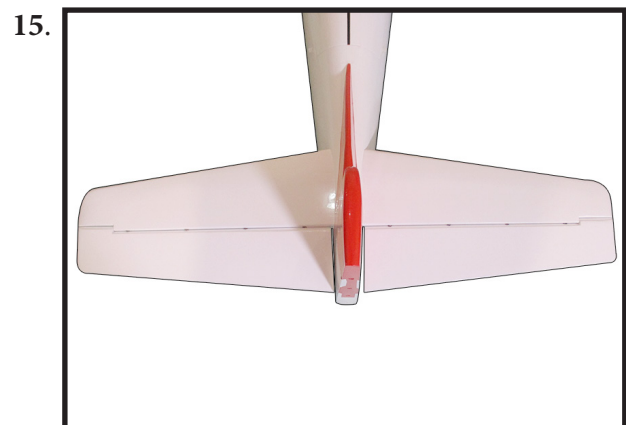

Gently pull on the fixed and moving surface to make sure the hinges are glued securely. If not, reapply thin CA to any hinges that are found loose.



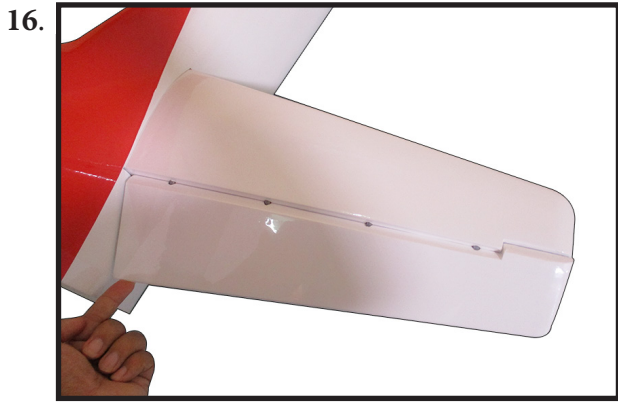

Flex the control surface through its range of motion a few 28. times to break-in the hinges. This will reduce the initial load on the servo when the surface is fist actuated.

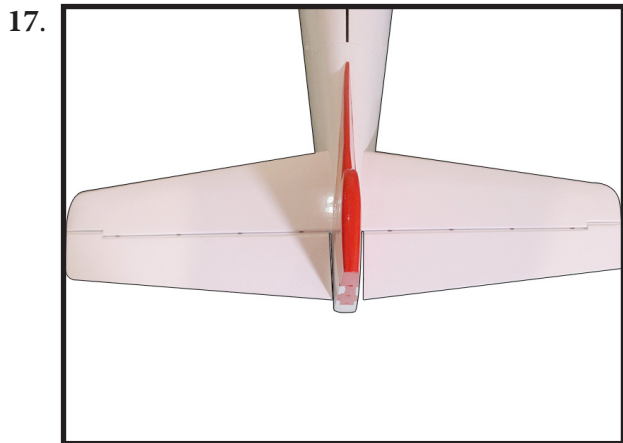

**INSTALL RUDDER CONTROL HORN**

Install the rudder control horn using the same method as the aileron control horns.

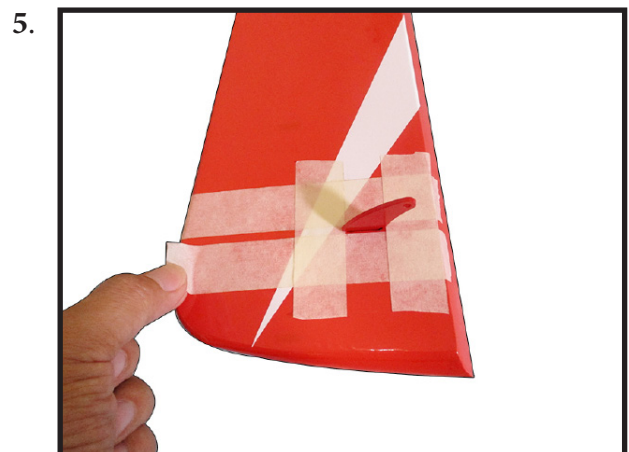
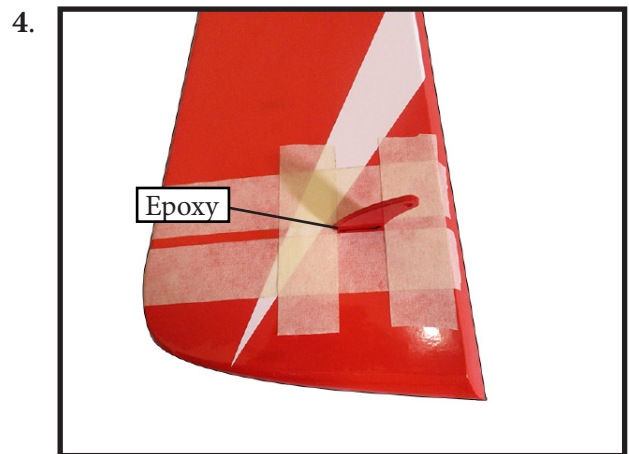
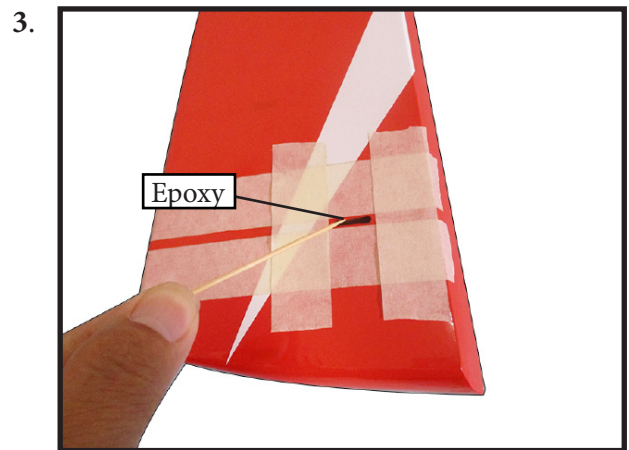
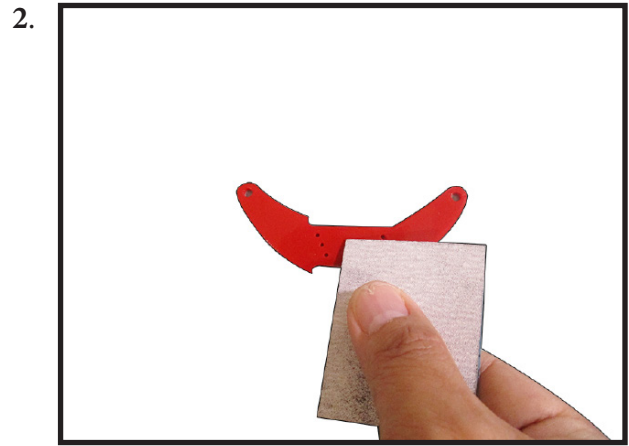
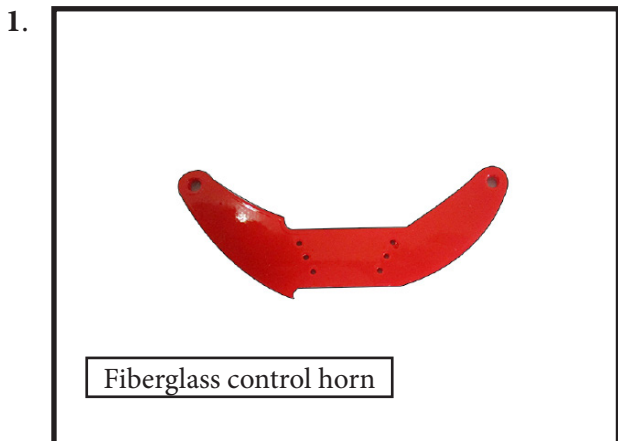

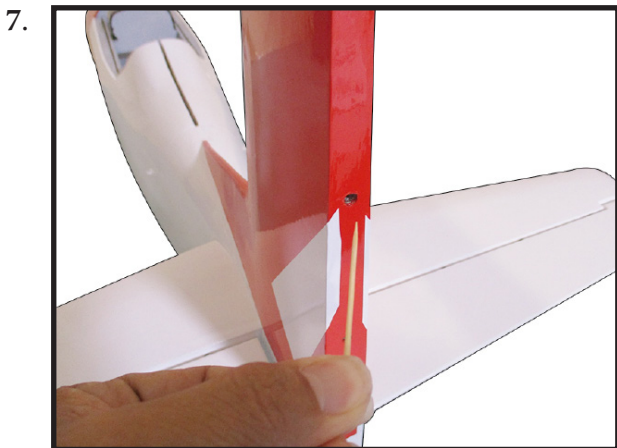
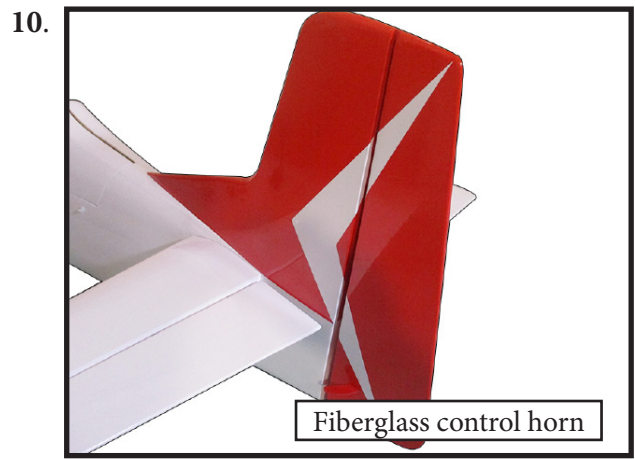

**ELEVATOR PUSHROD HORN  
INSTALLATION**

Install the elevator control horn using the same method as with the aileron control horns.

Position the elevator control horns on both side of the elevator.

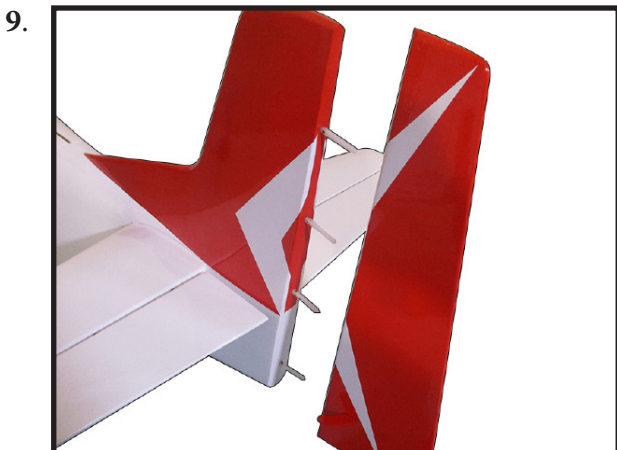
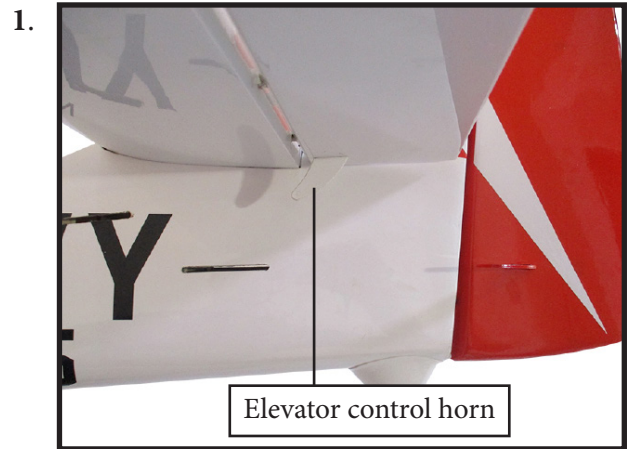

Thread one clevis and M3 lock nut on to each elevator control rod. Thread the horns on until they are flush with the ends of the control rods.

Assemble the elevator and rudder pushrods as shown in images below.

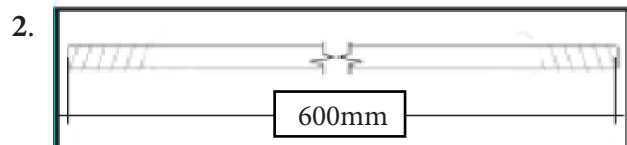



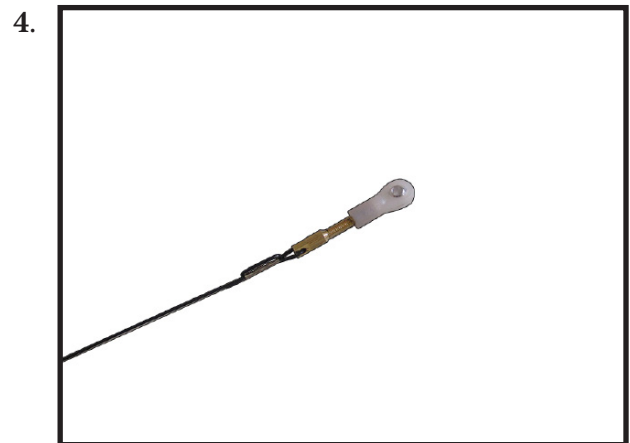
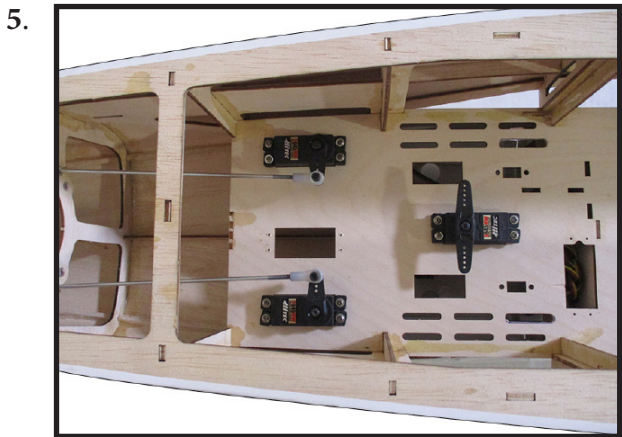
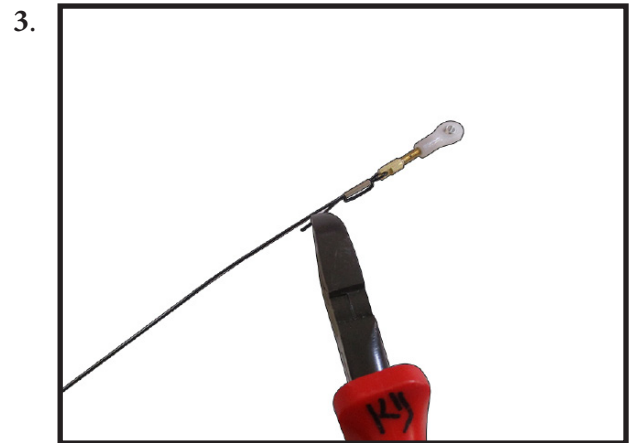
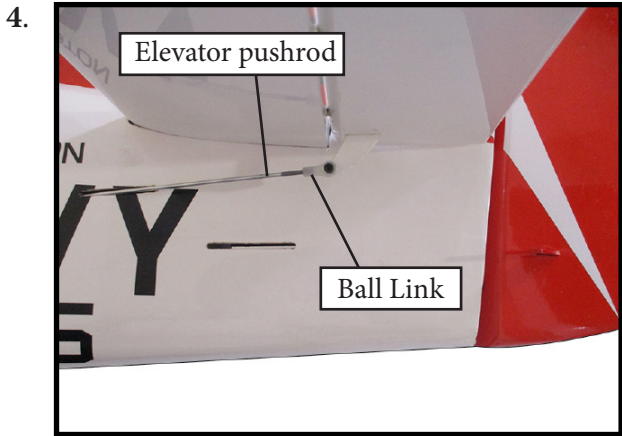
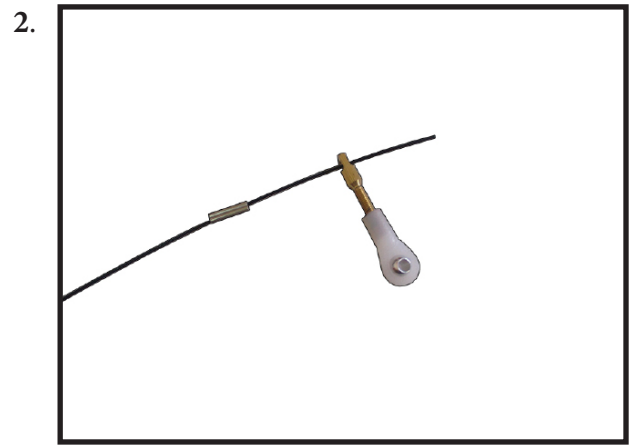
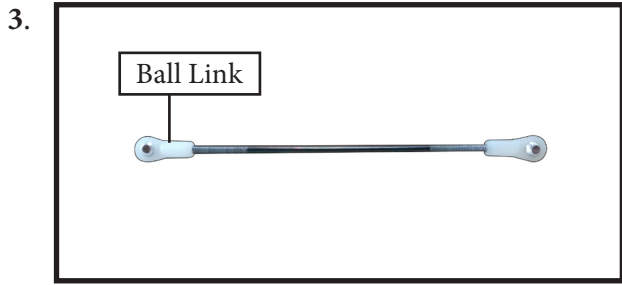

### RUDDER CABLE INSTALLATION

Study images below to install pull-pull cable set.



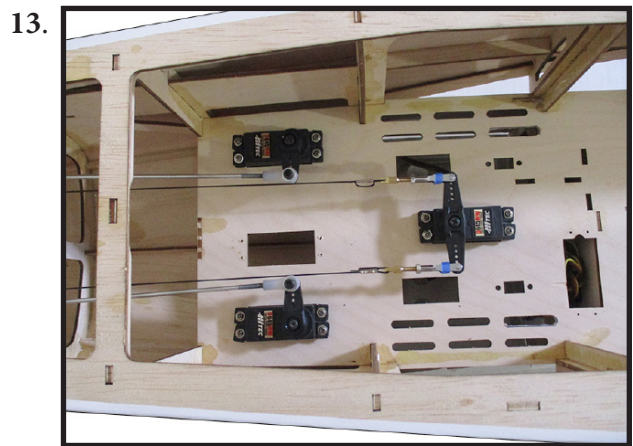
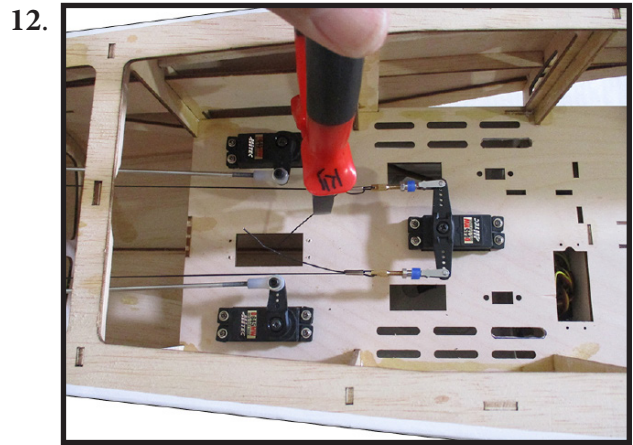
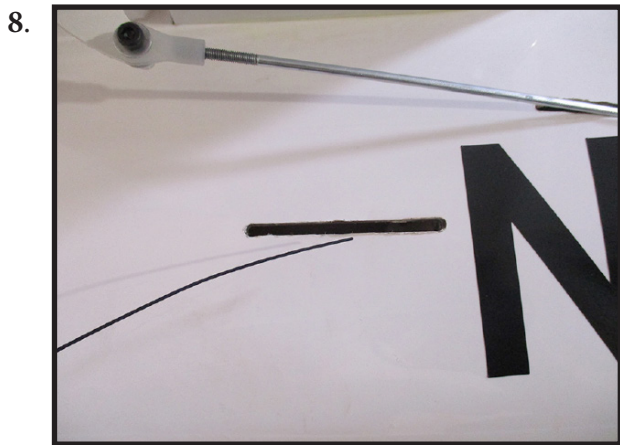
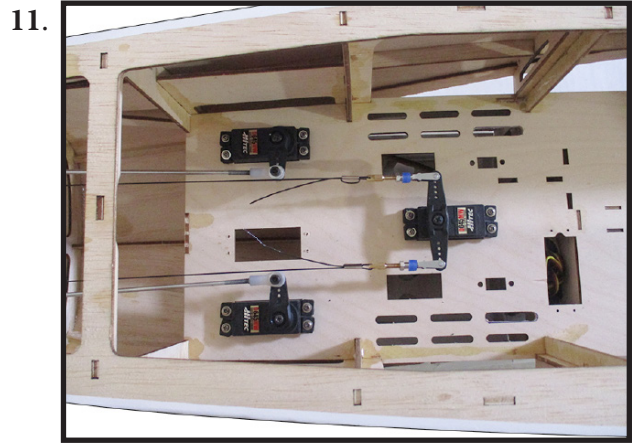
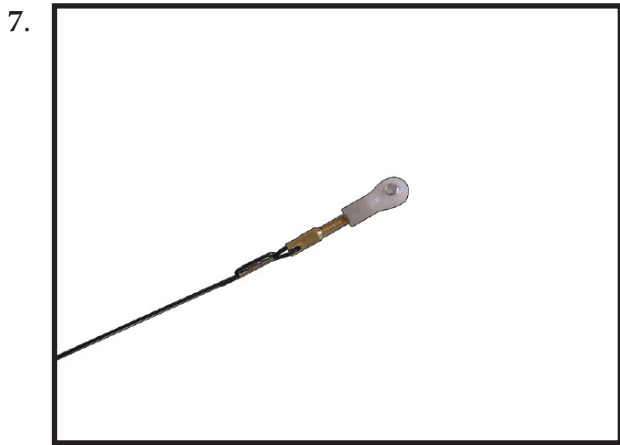
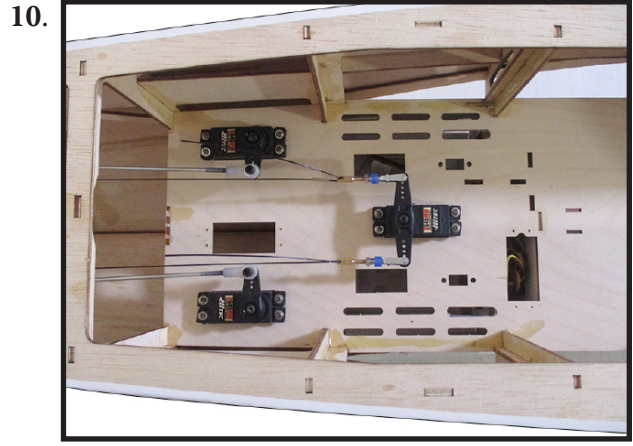
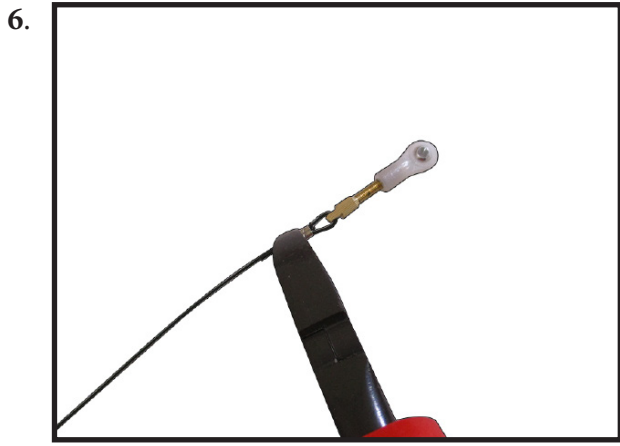



## INSTALL THE WIND SHIELD

Please study images below.

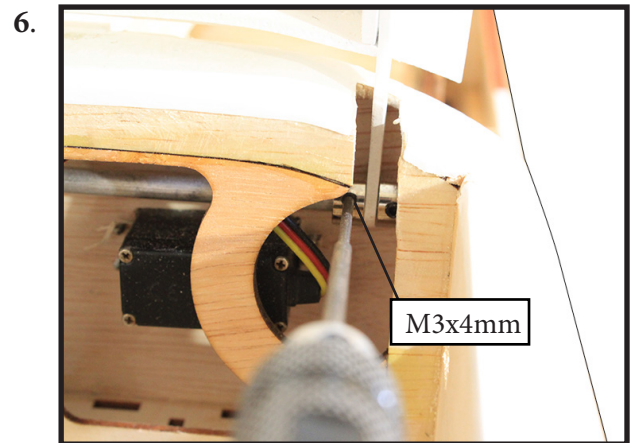
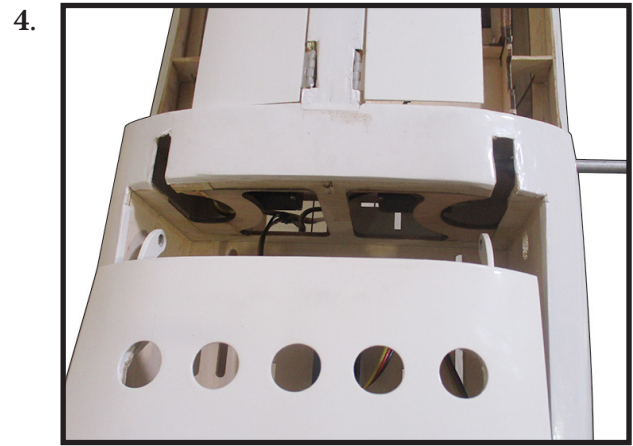
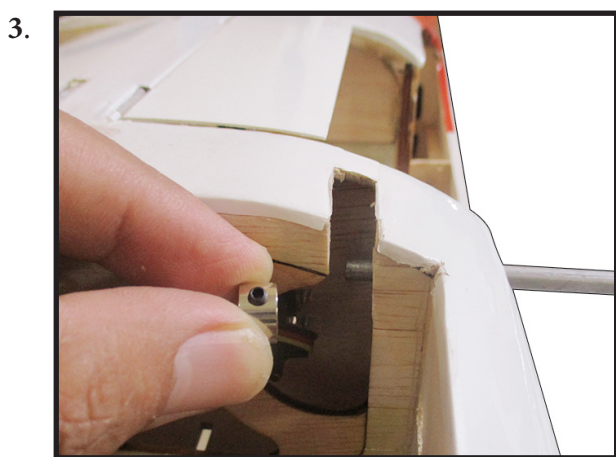
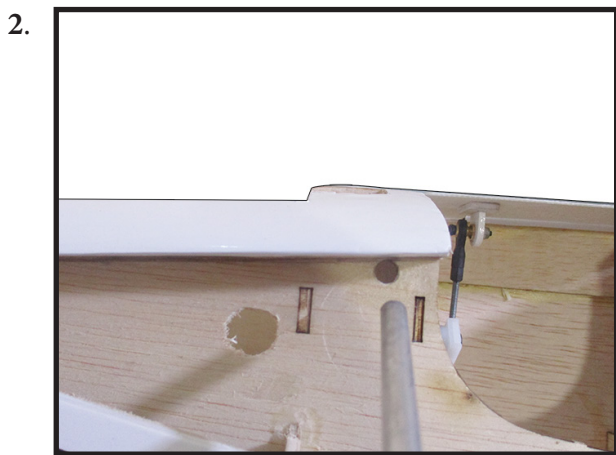
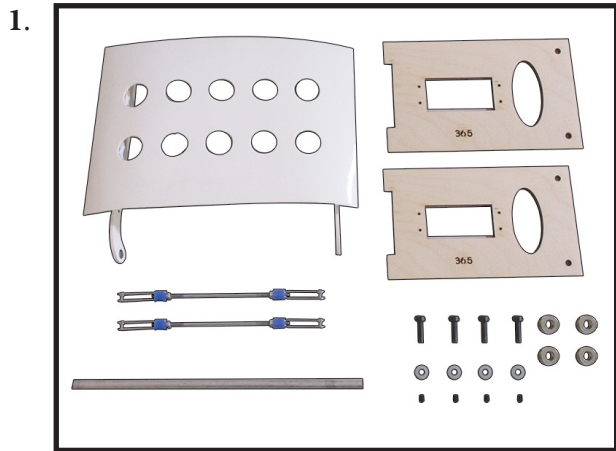

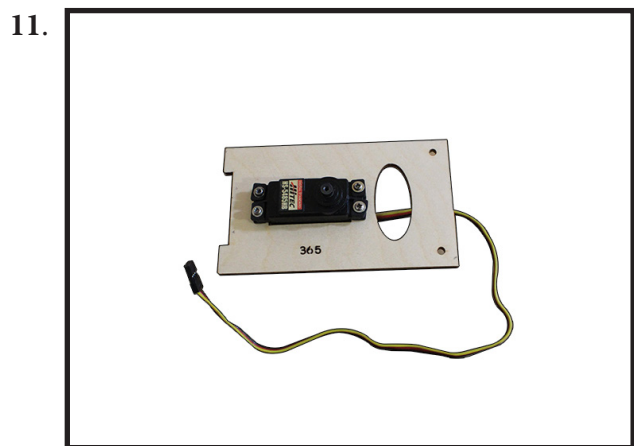
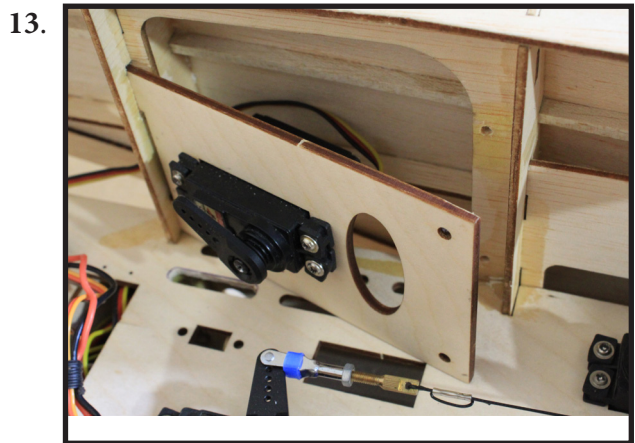
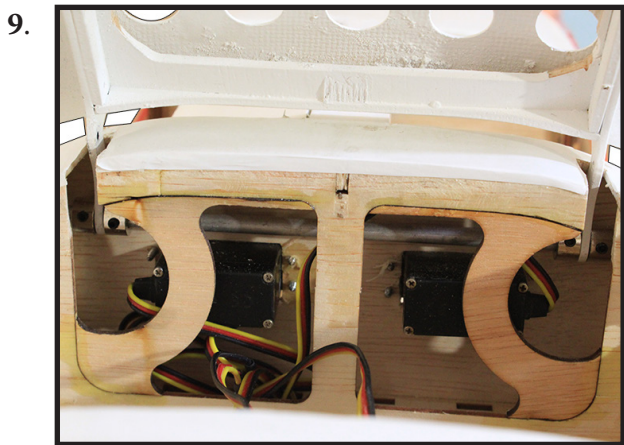
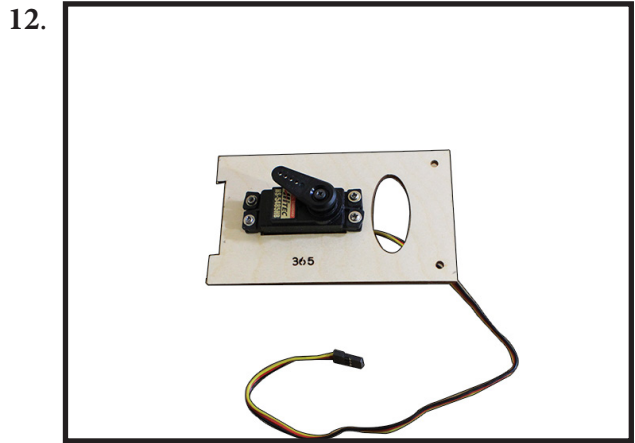
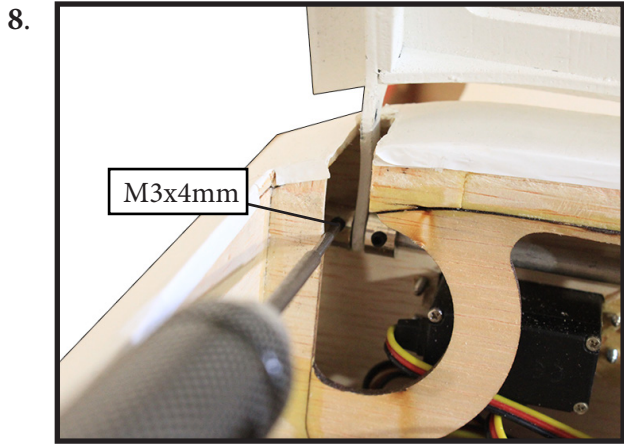



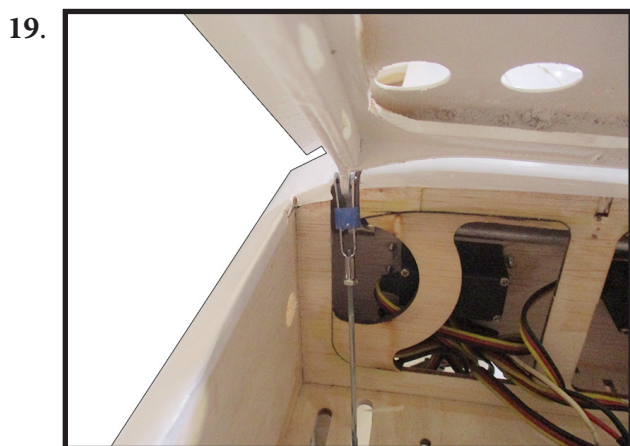
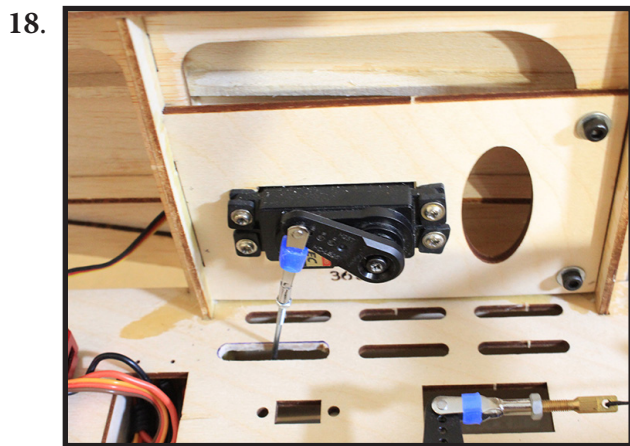
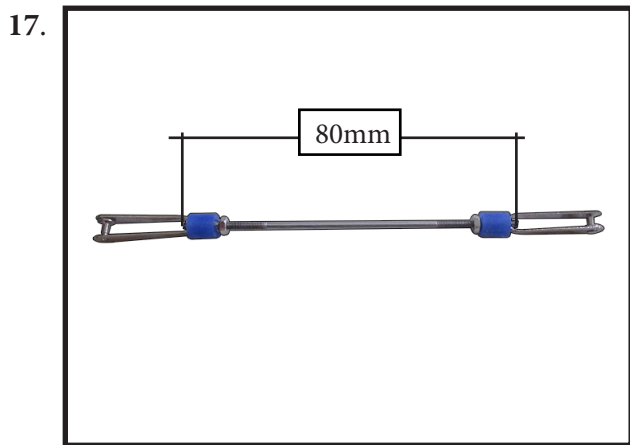
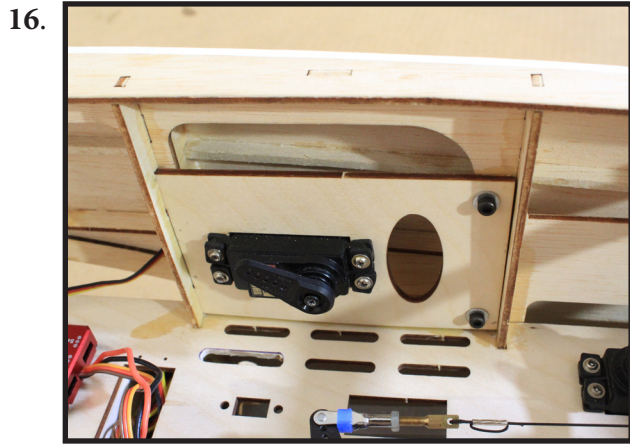

### INSTALLING THE BATTERY-RECEIVER

Plug the servos leads and the switch lead into the receiver. Plug the battery pack lead into the switch also.

Wrap the receiver and battery pack in the protective foam rubber to protect them from vibration.

Route the antenna in the antenna tube inside the fuselage and secure it to the bottom of fuselage using a plastic tape.

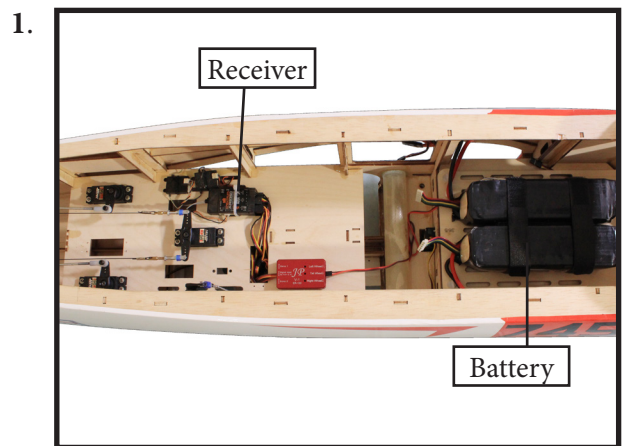

**ATTACHMENT WING- FUSELAGE**

Attach the aluminium tube into fuselage.

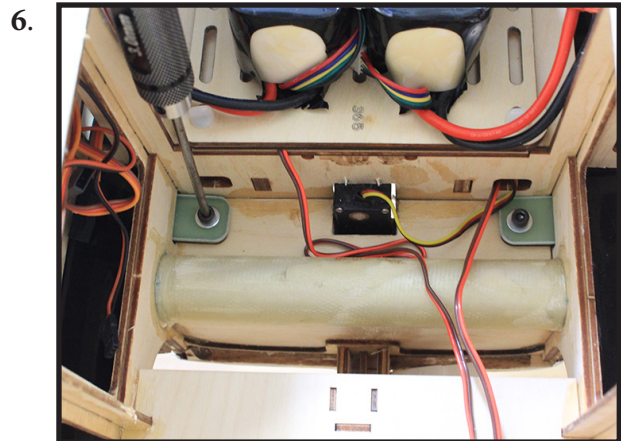
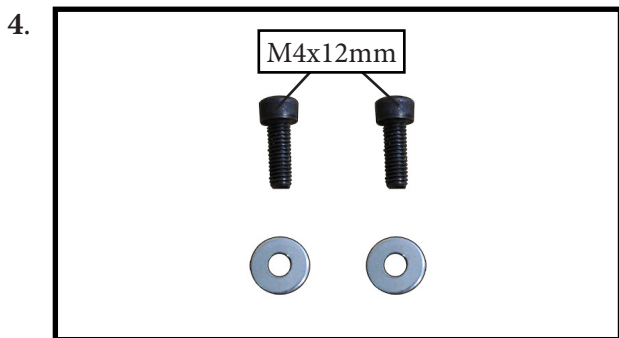
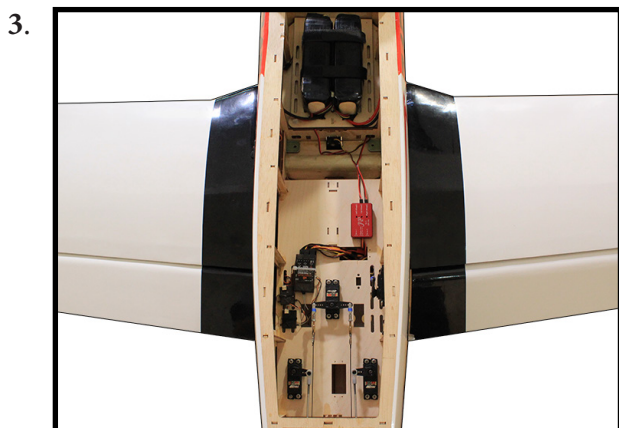
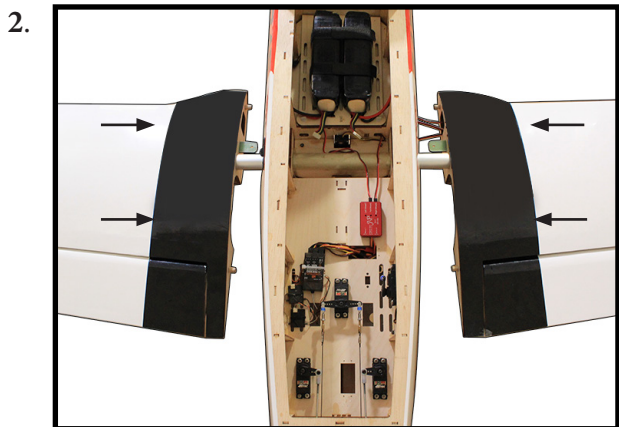
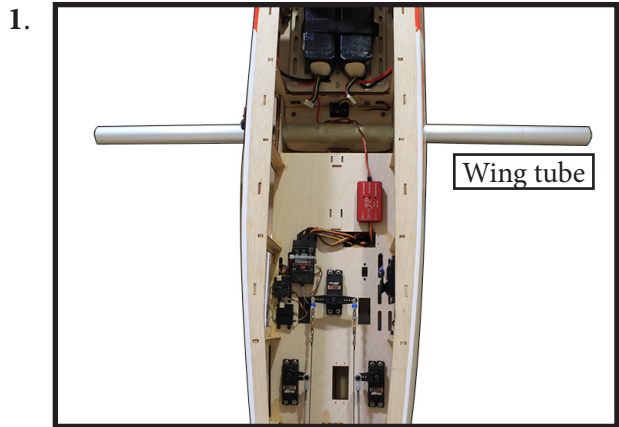

**INSTALLATION COCKPIT, PILOT AND CANOPY**

Locate items necessary to install.

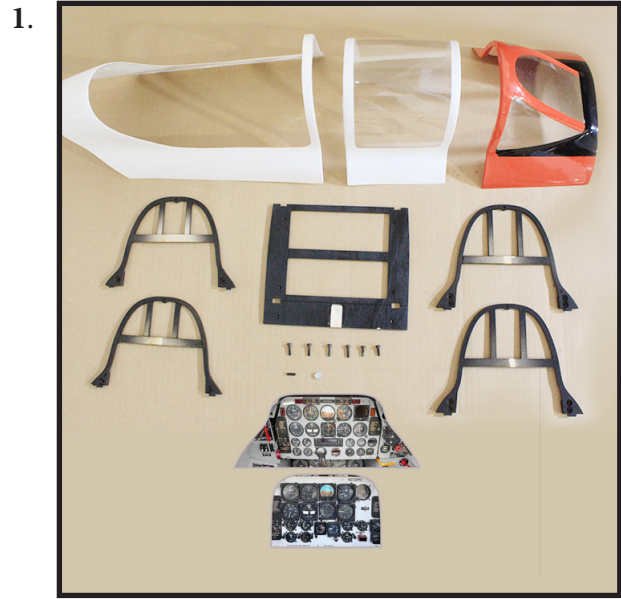



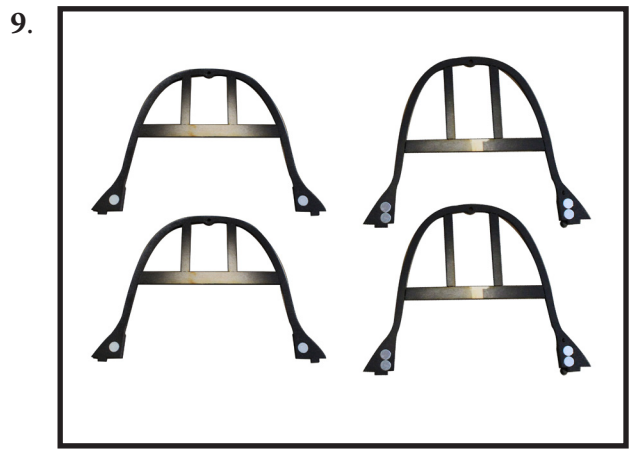
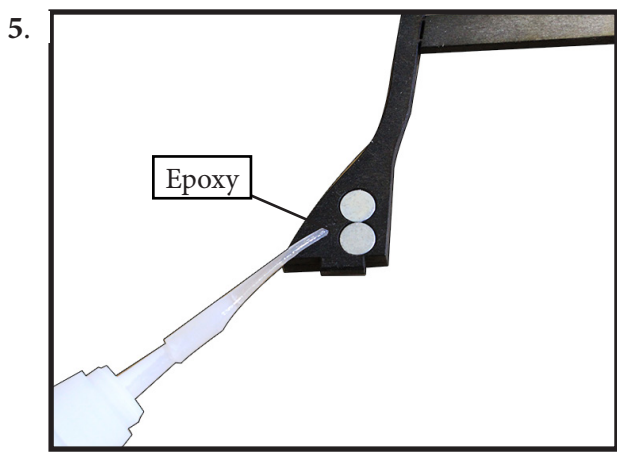
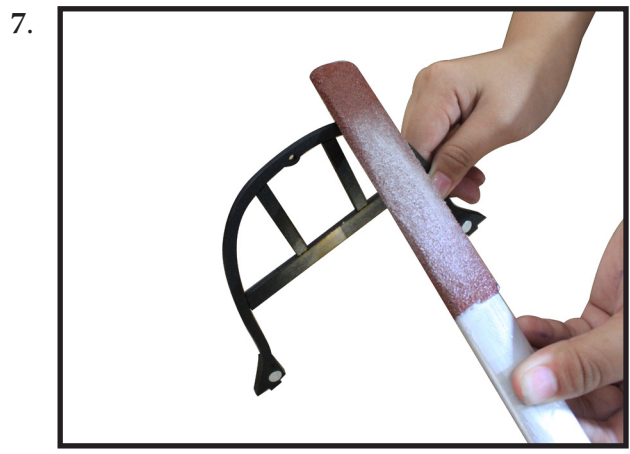
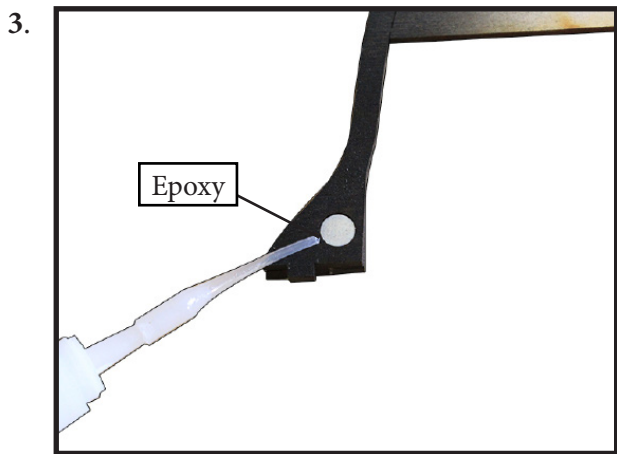
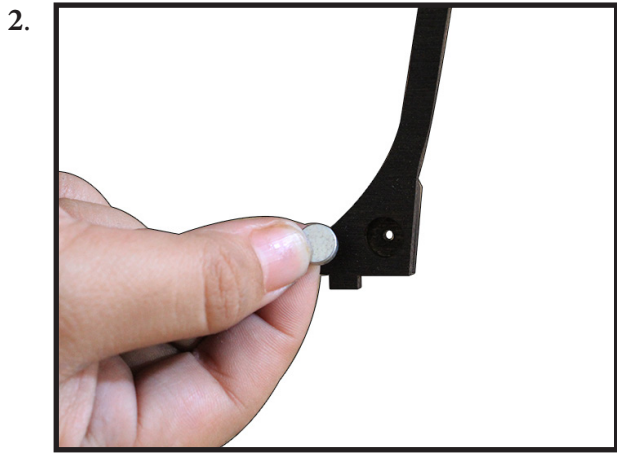

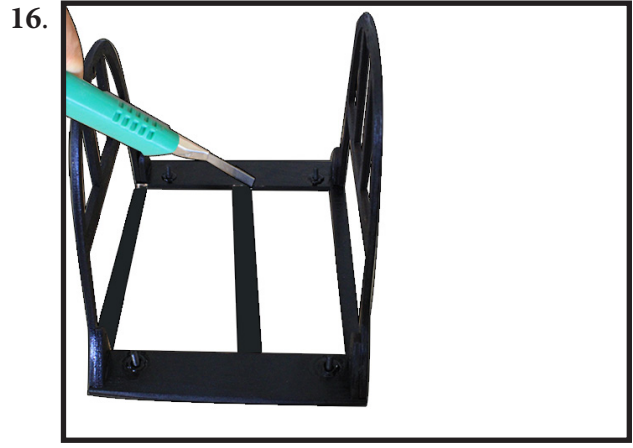
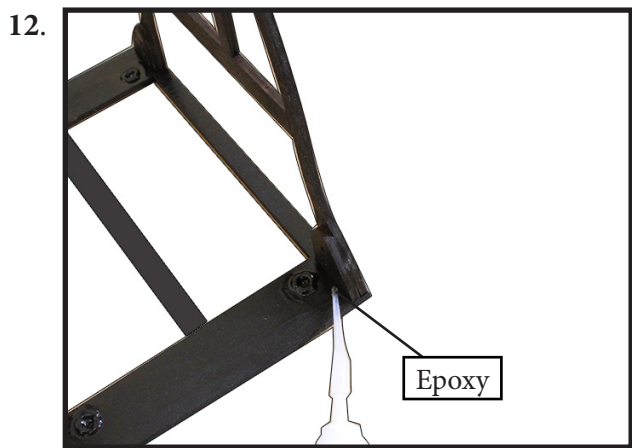
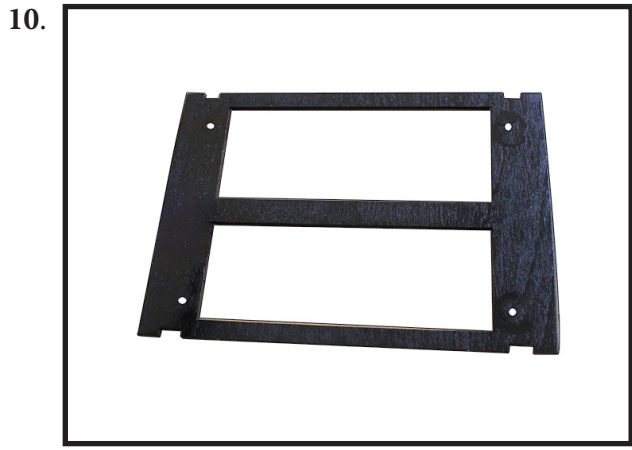



18.

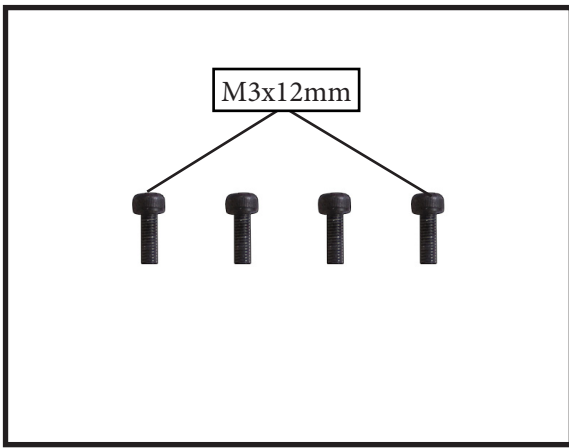

22.

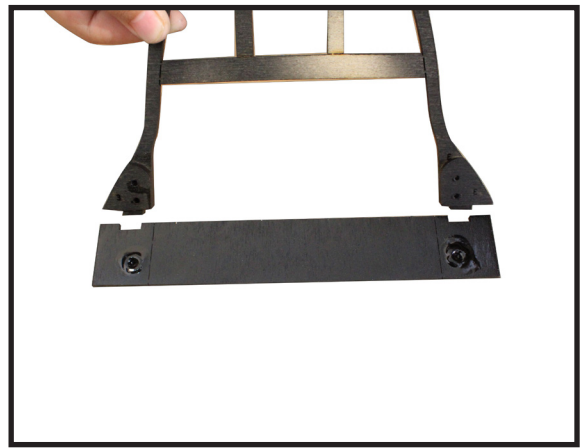

19.



23.

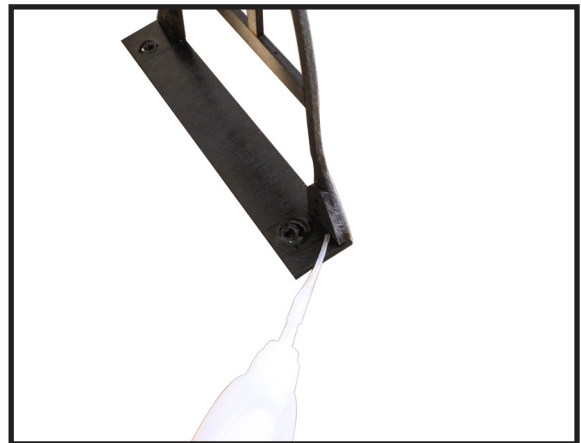

20.



24.



21.



25.



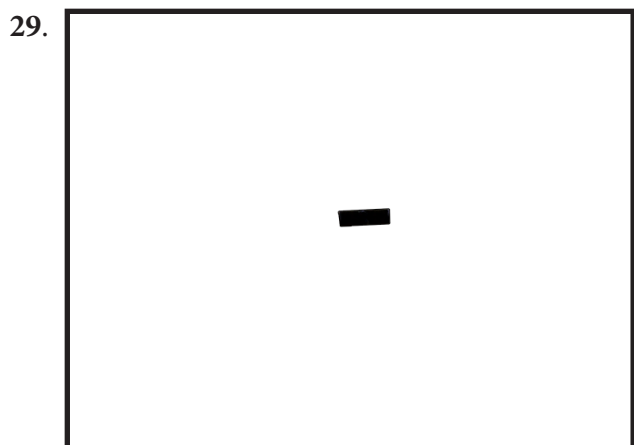
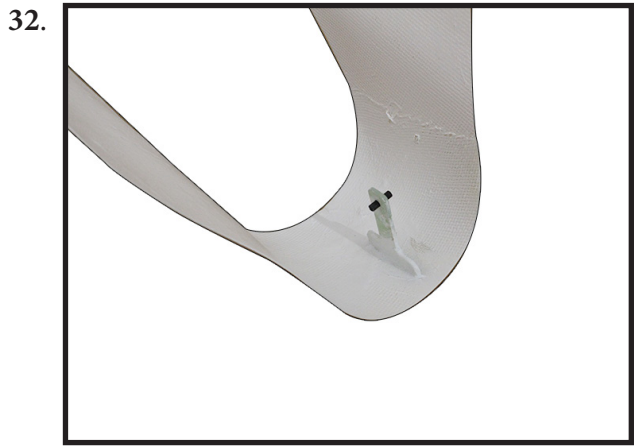
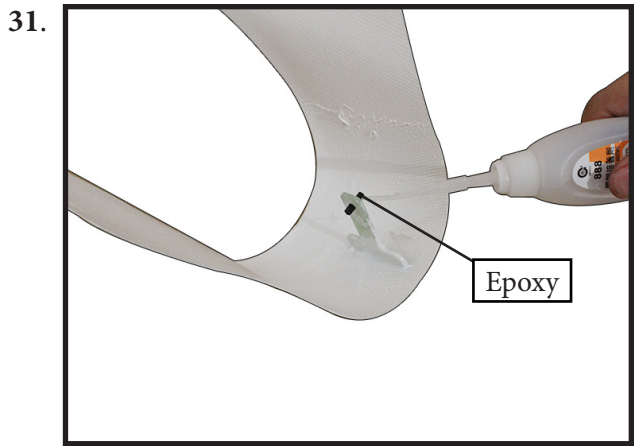
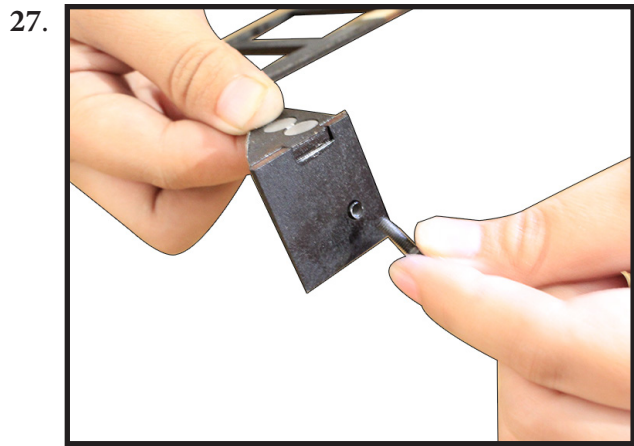
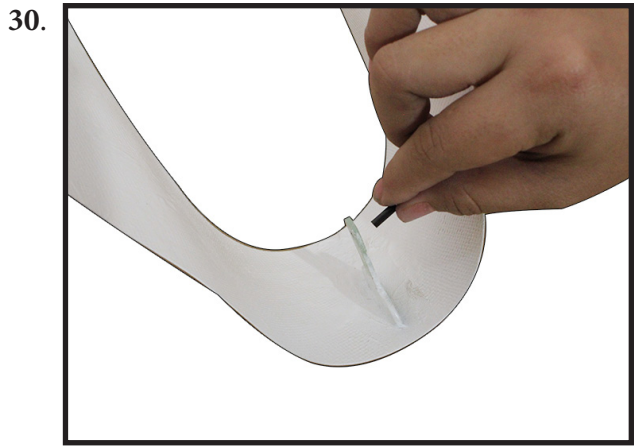
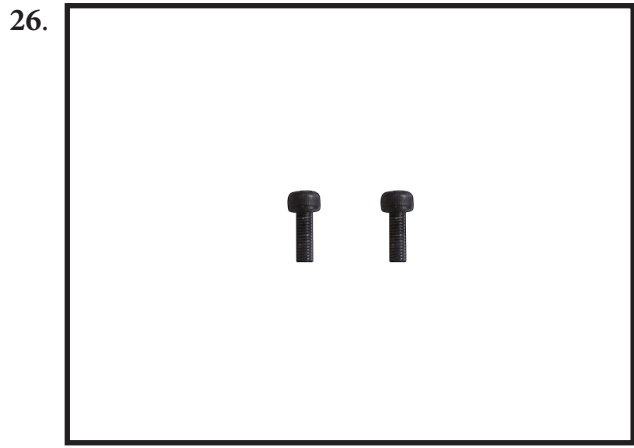



34.

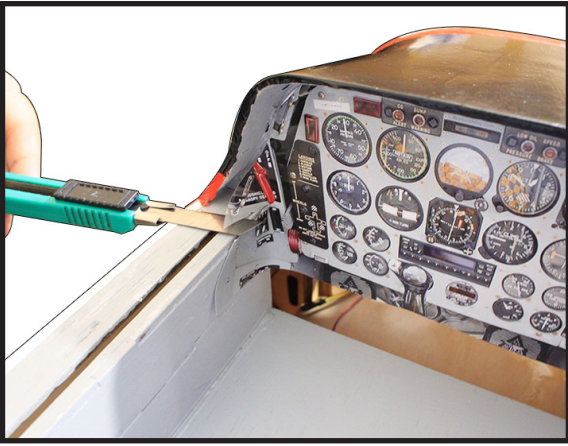

38.

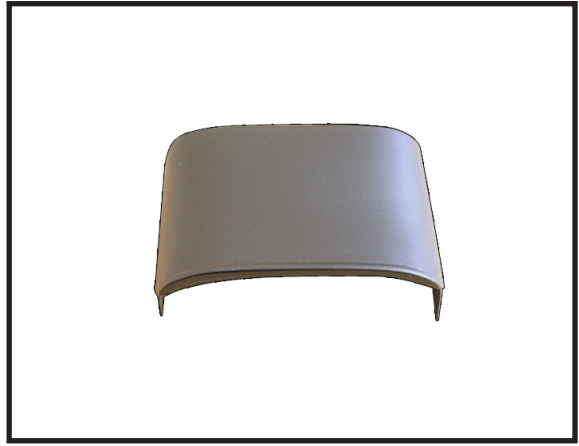

35.



39.

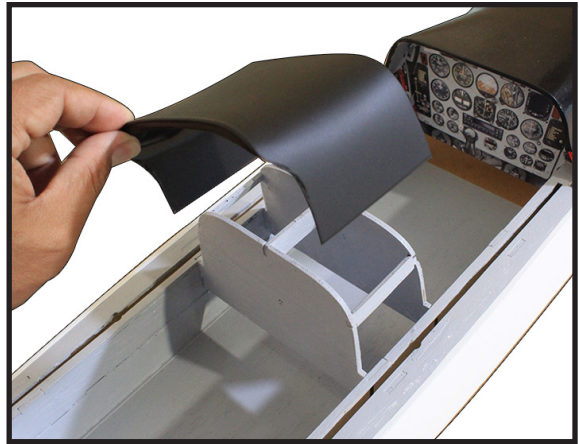

36.

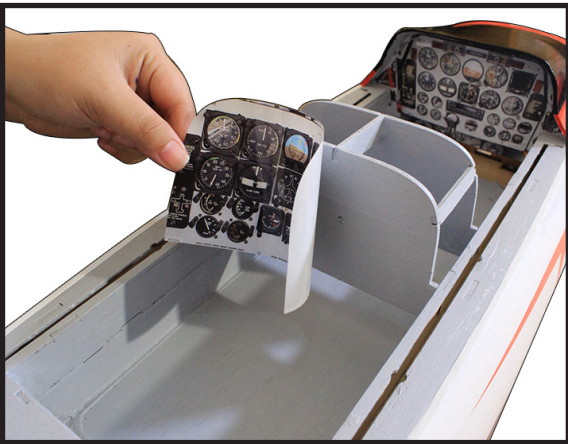

40.

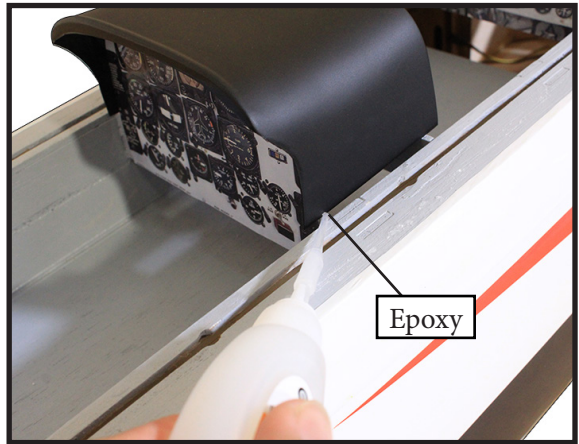

37.

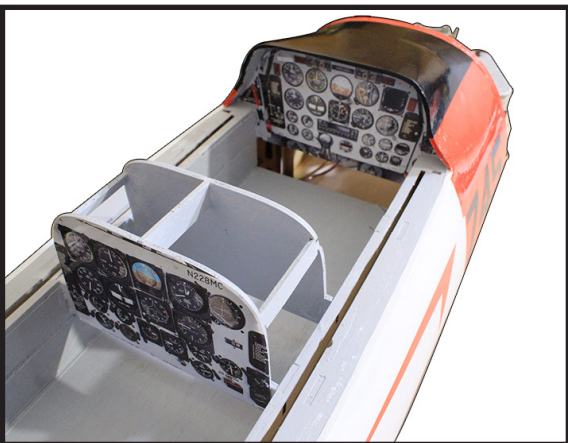

41.

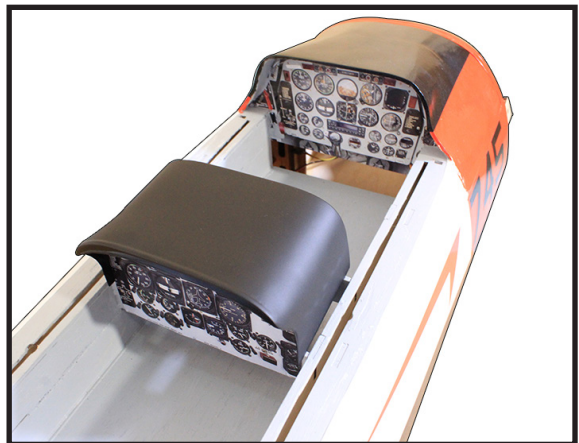

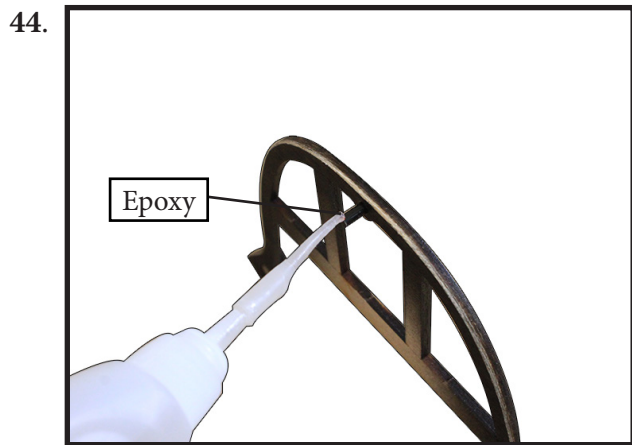
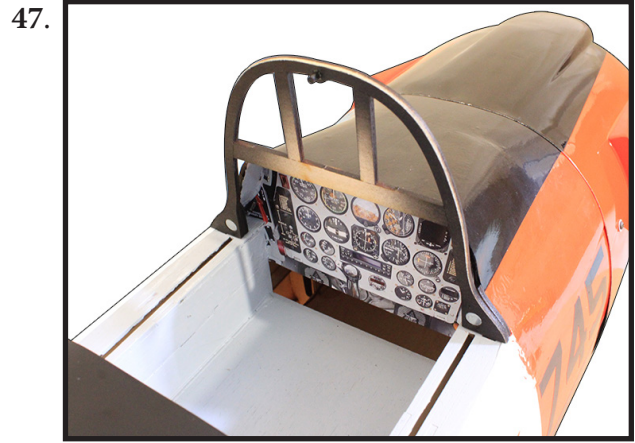
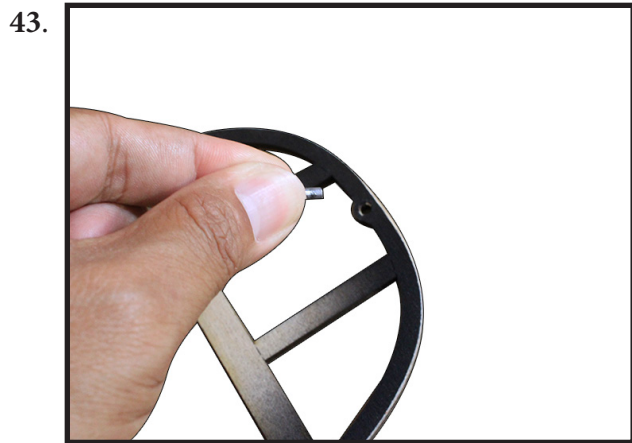
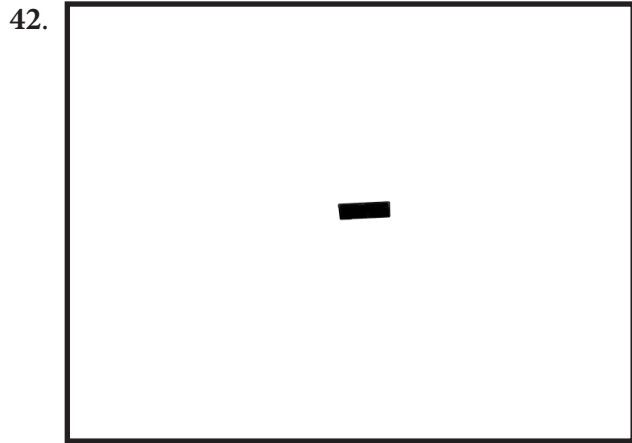



50.



54.

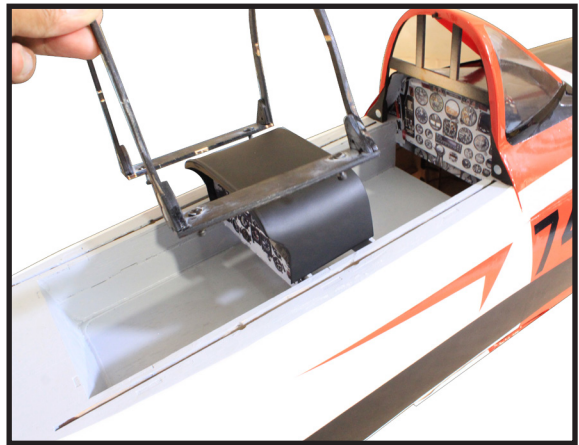

51.

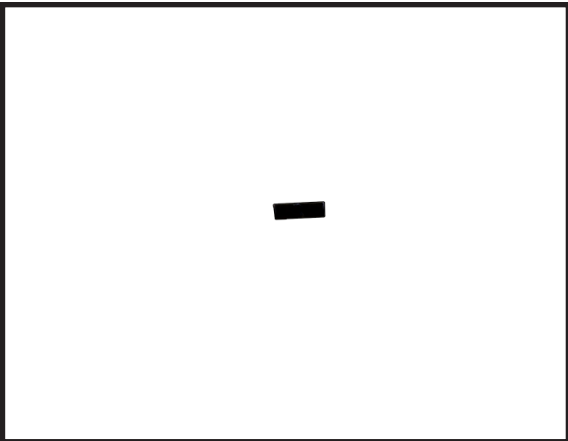

55.

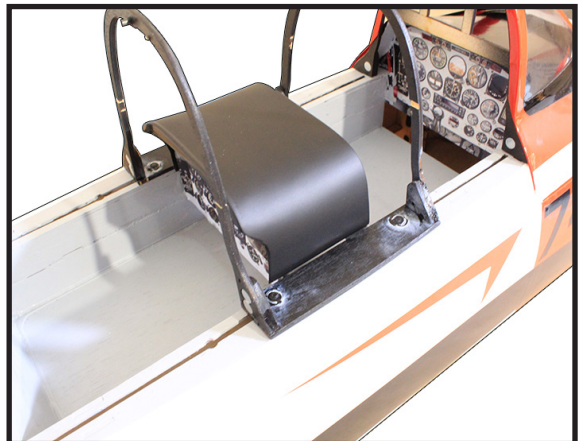

52.

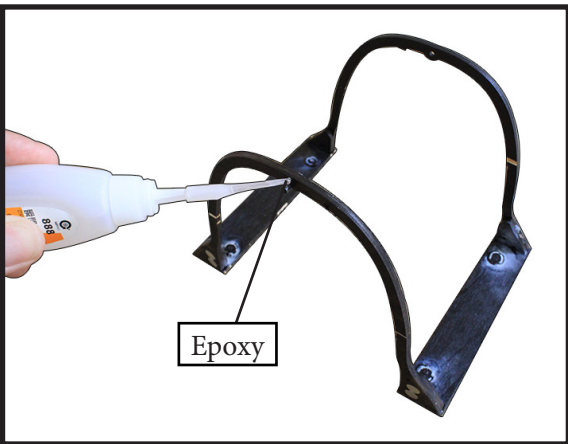

56.



53.



57.



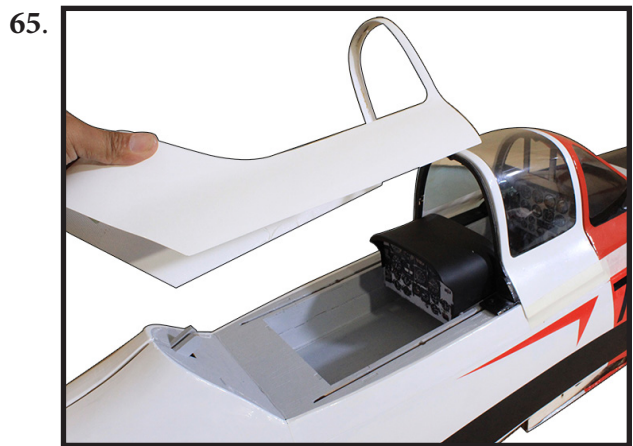
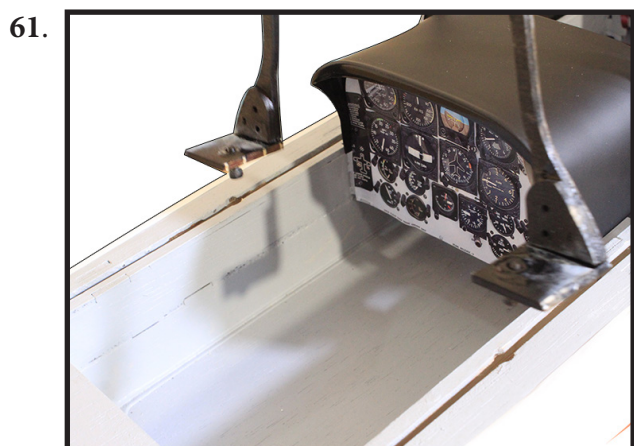
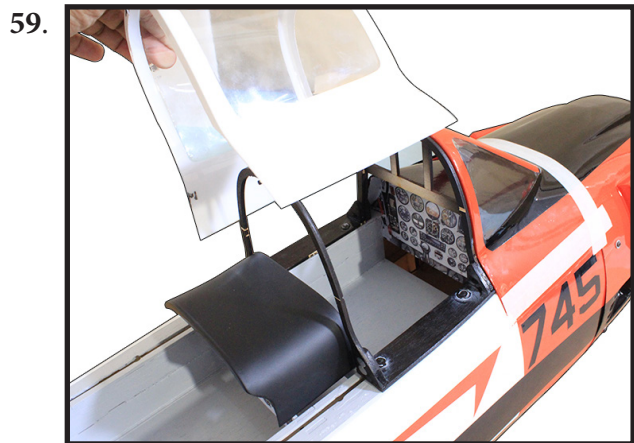
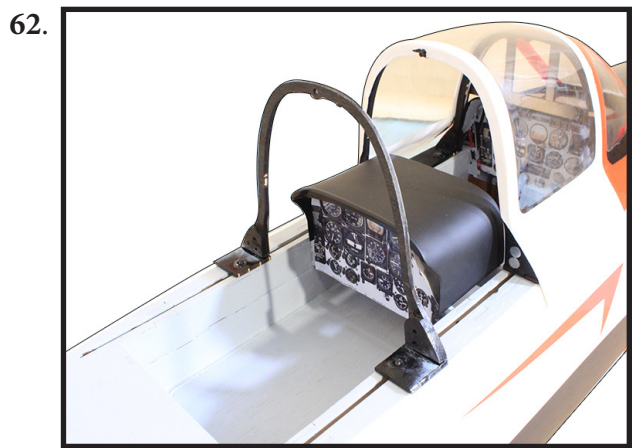
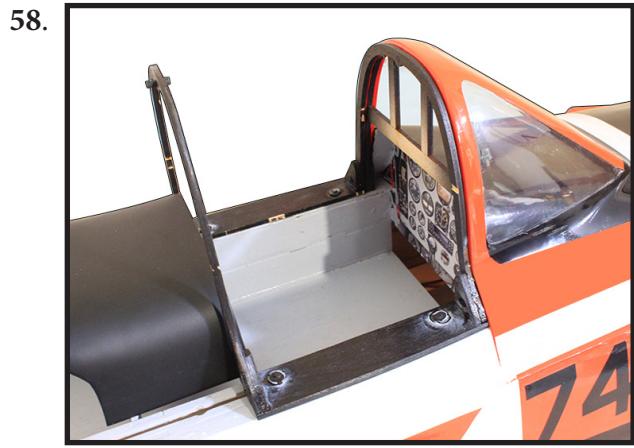



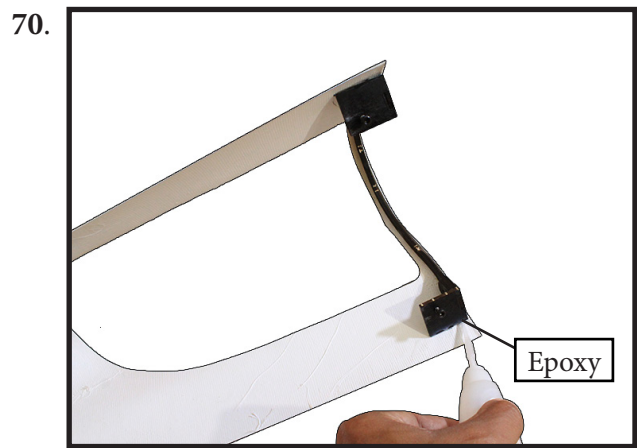
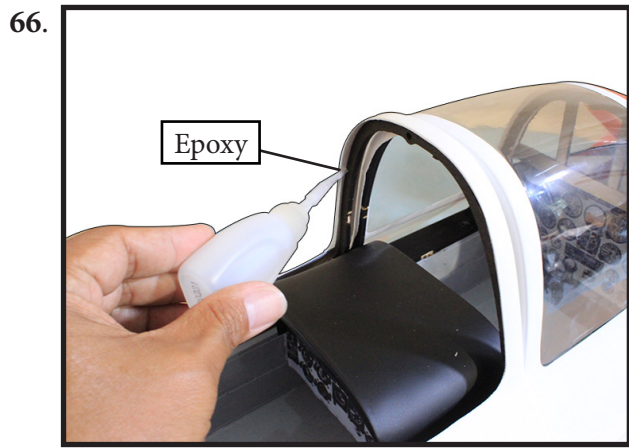

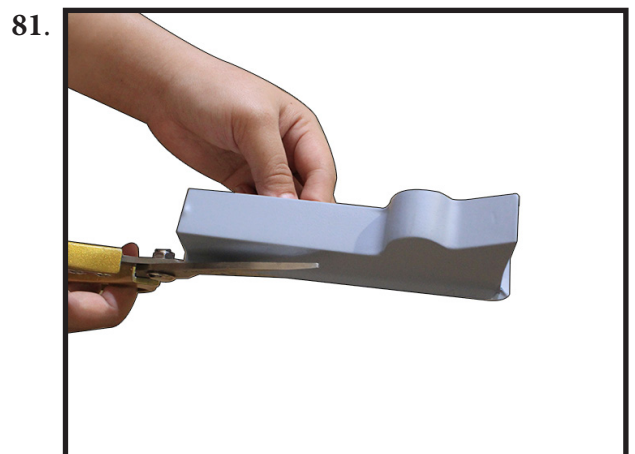
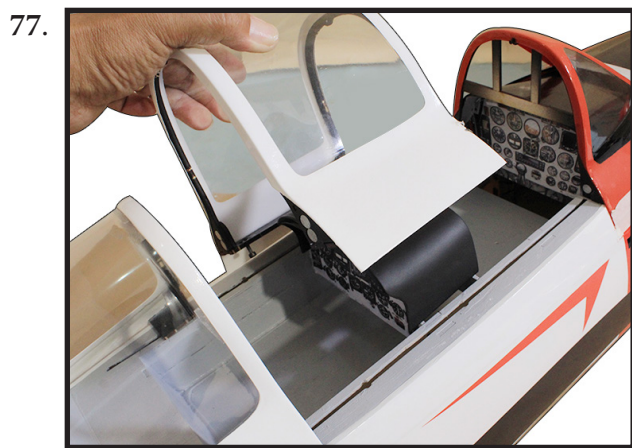
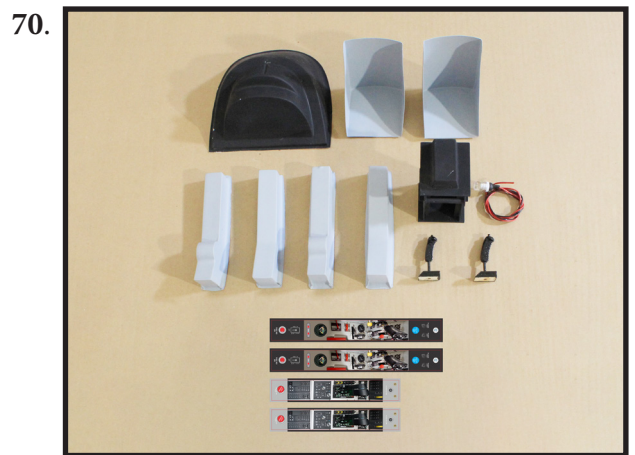



82.

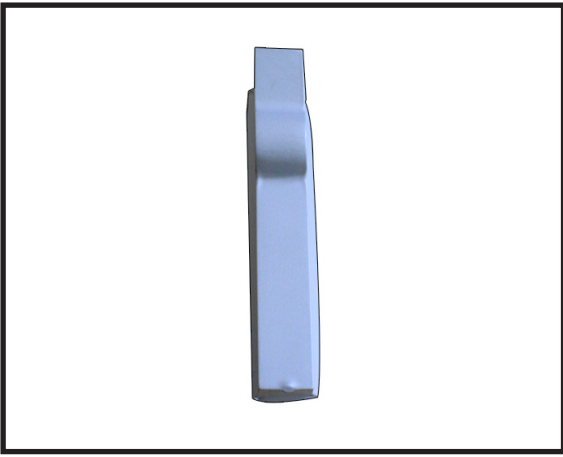

86.

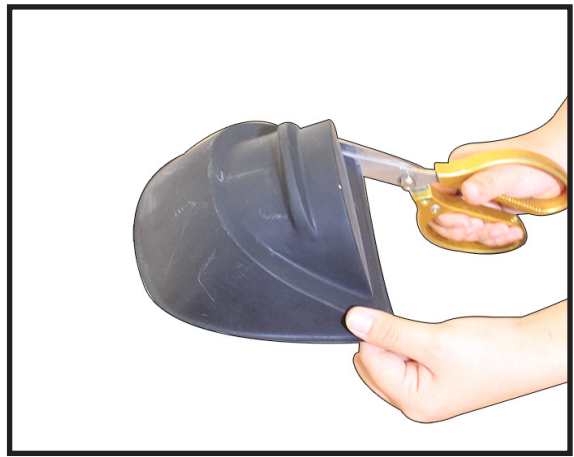

83.

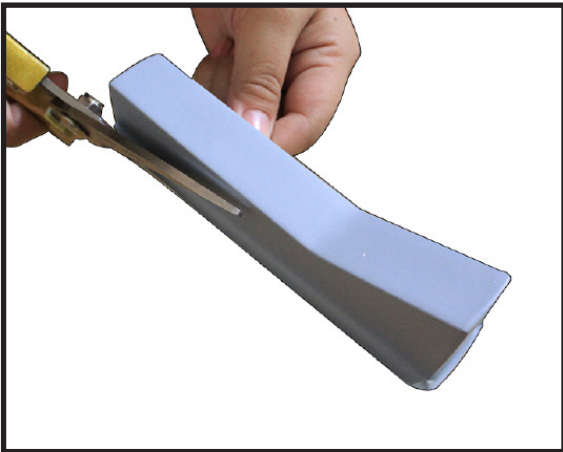

87.

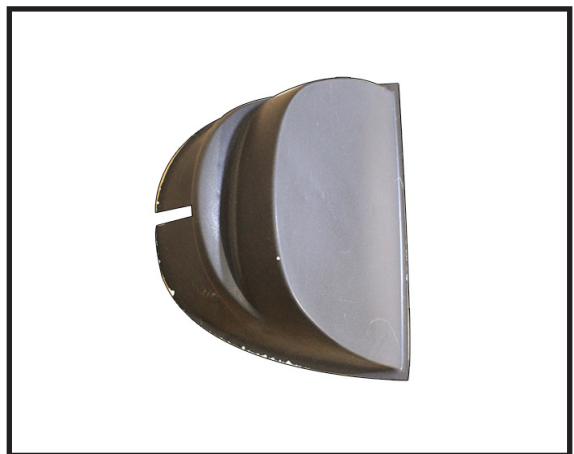

84.

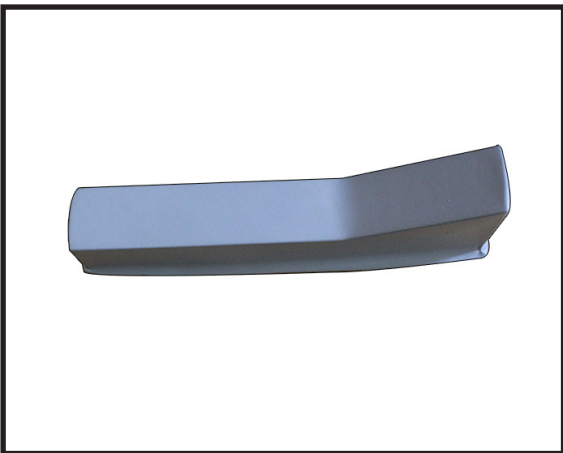

88.



85.

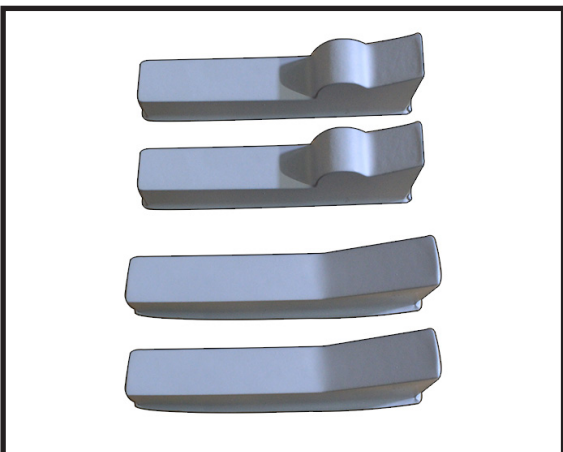

89.

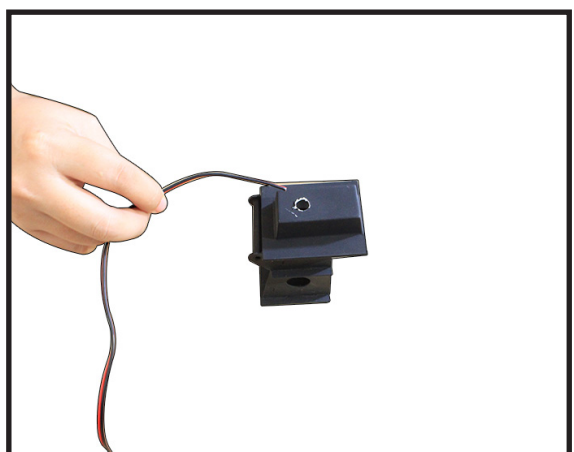

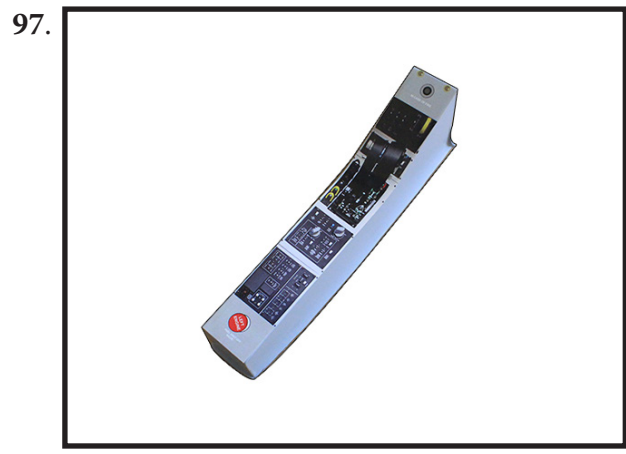
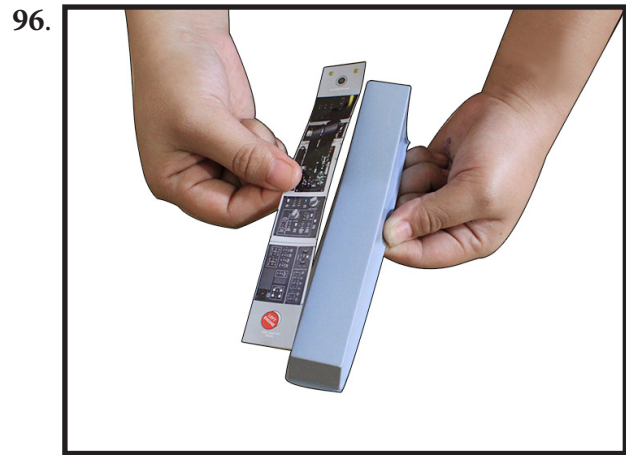
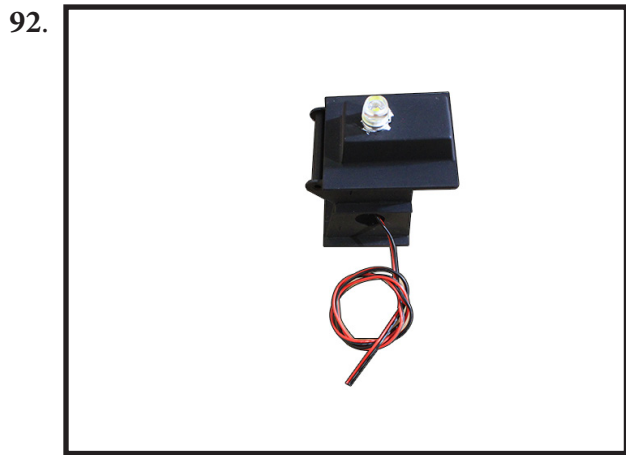
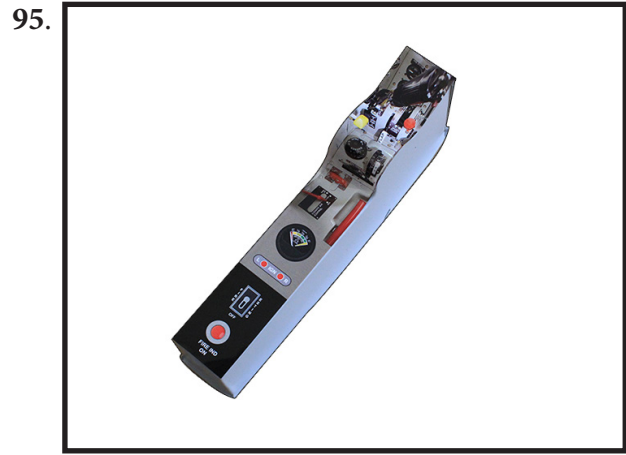
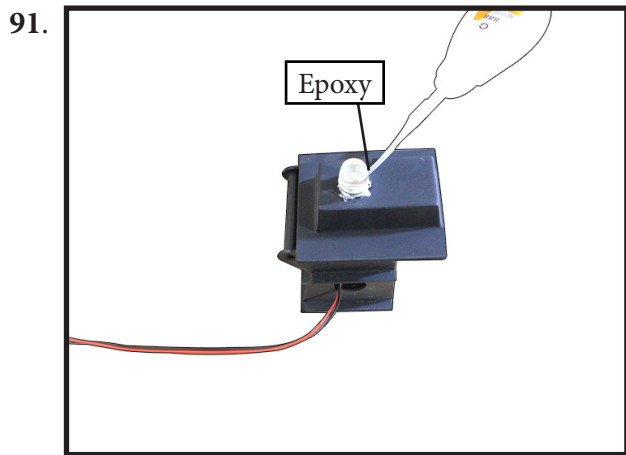
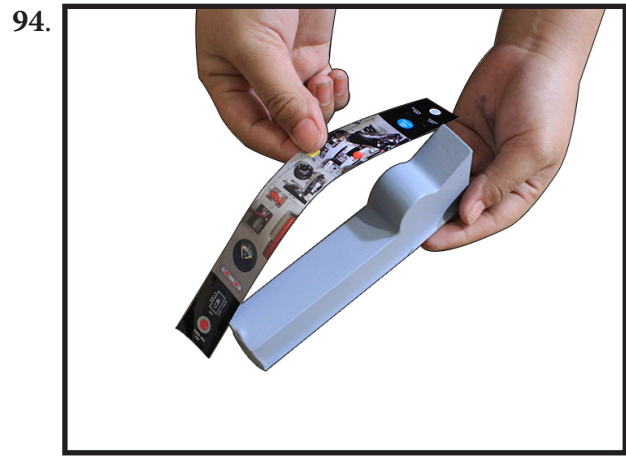
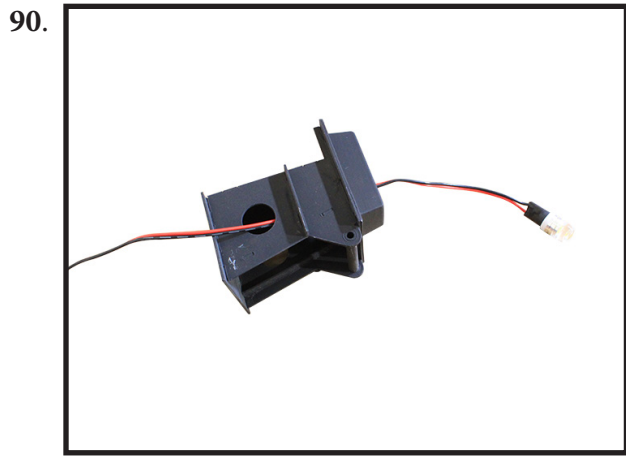



98.

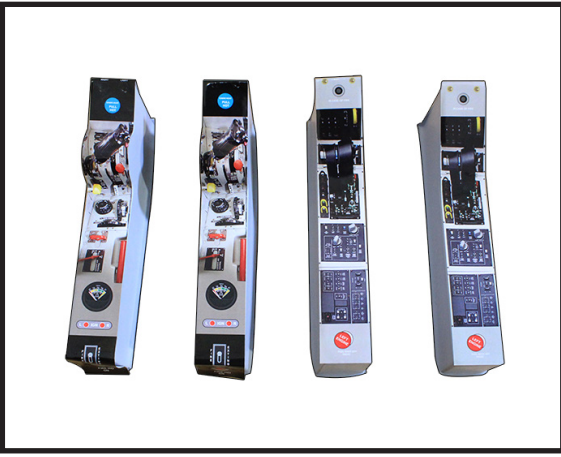

102.

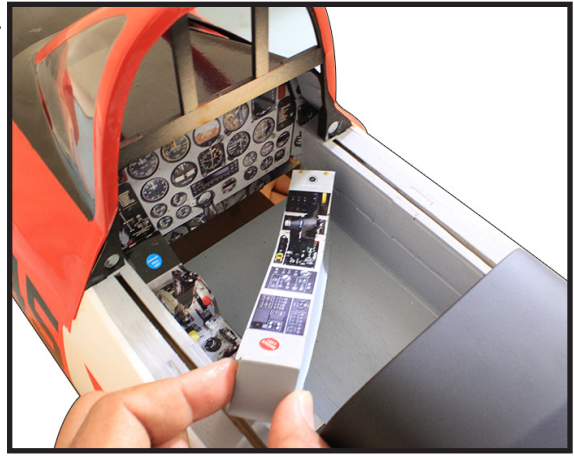

99.

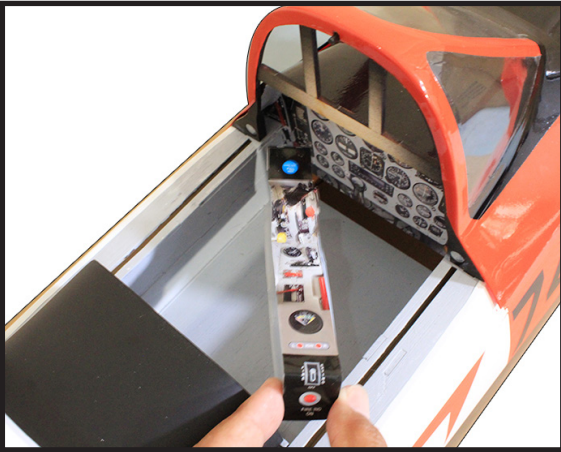

103.

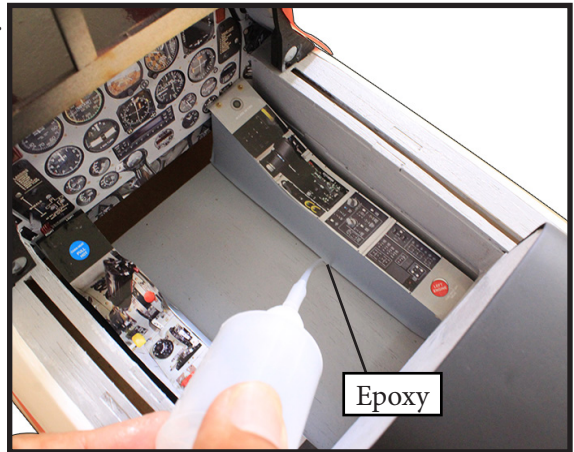

100.

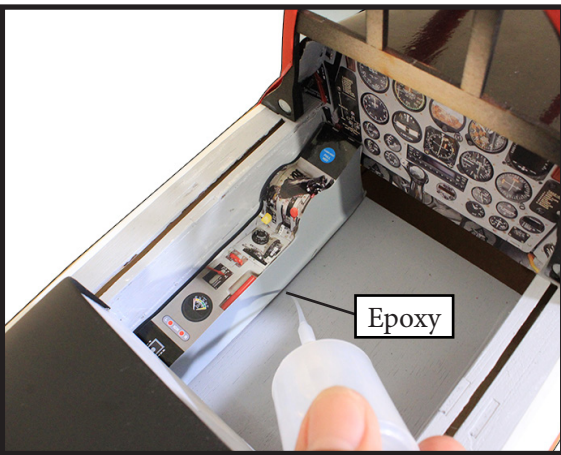

104.



101.

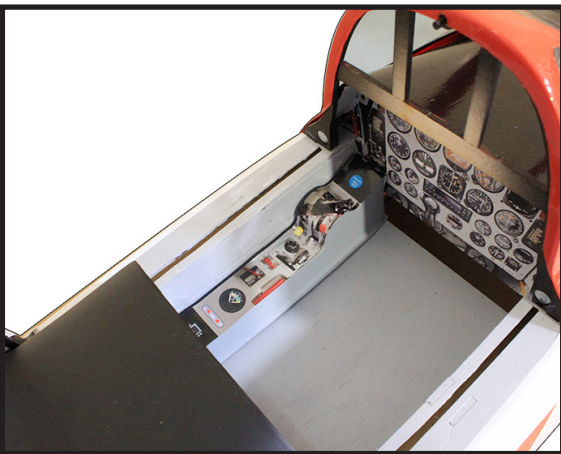

105.

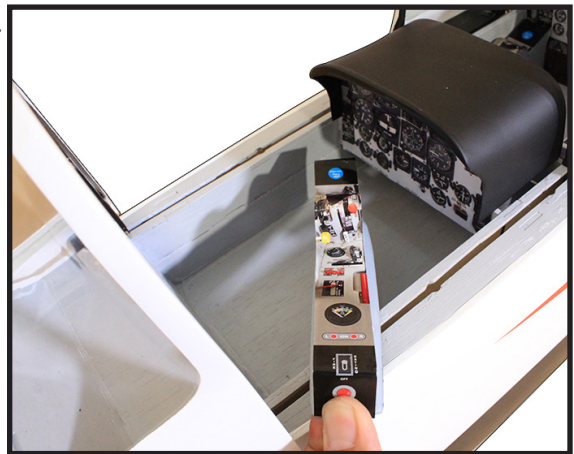



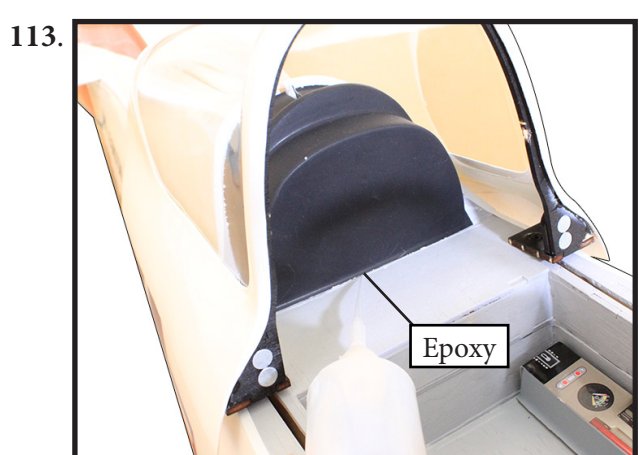
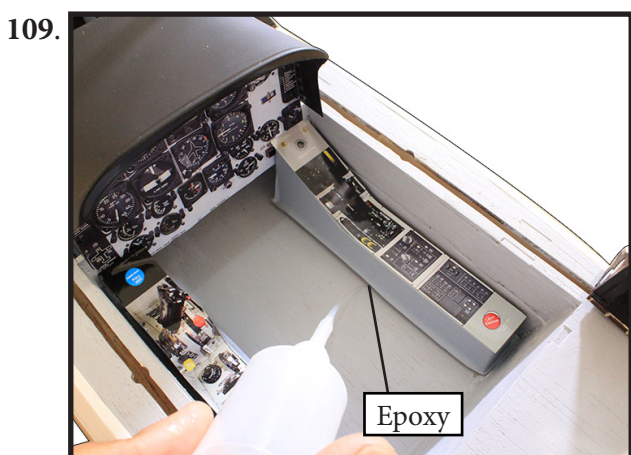
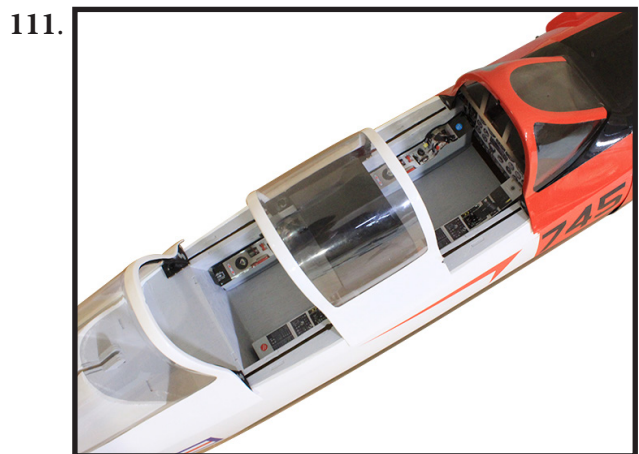
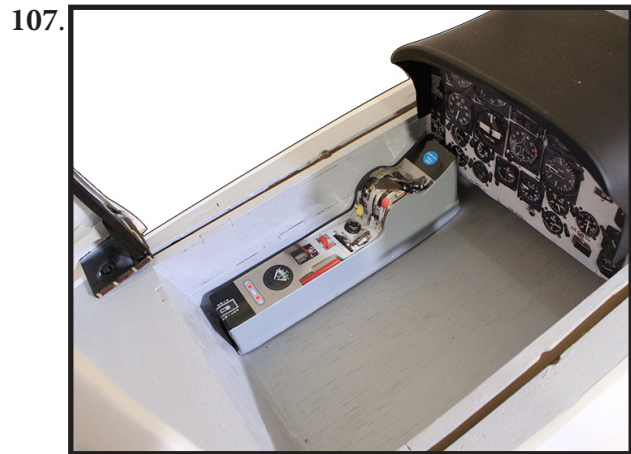
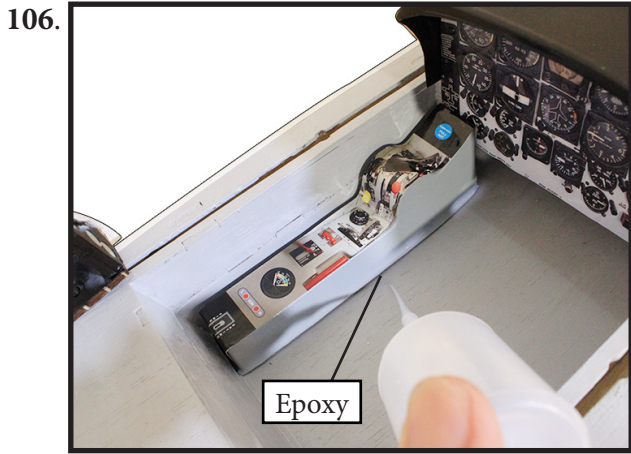



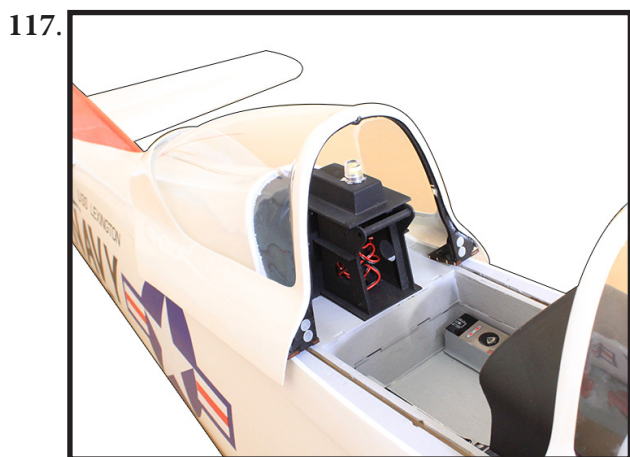
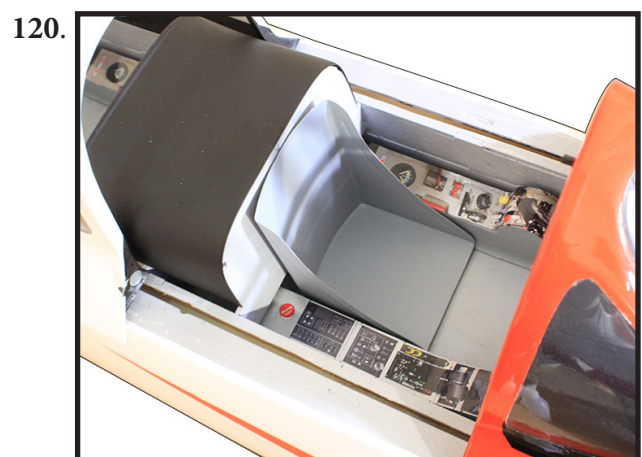
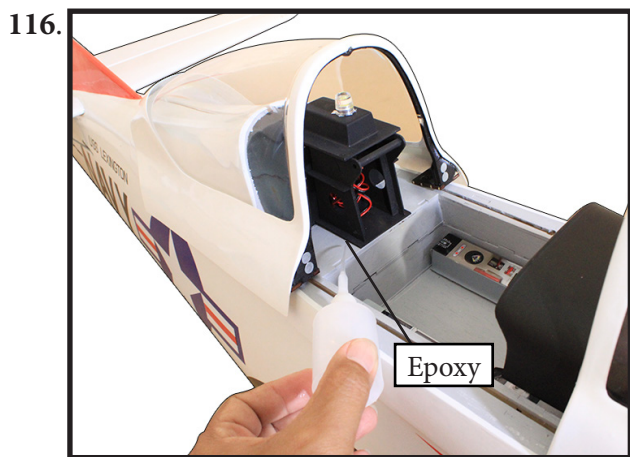
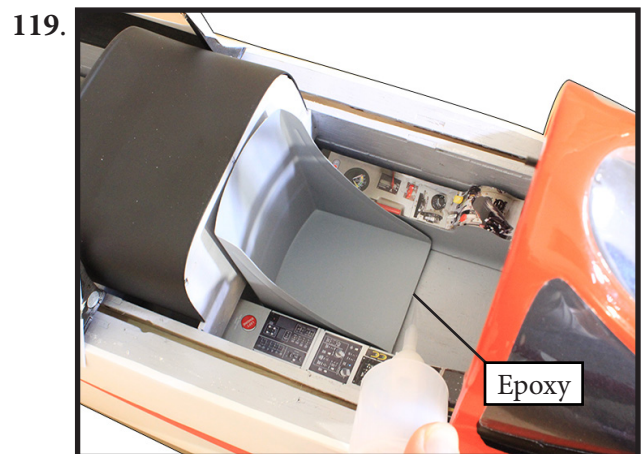
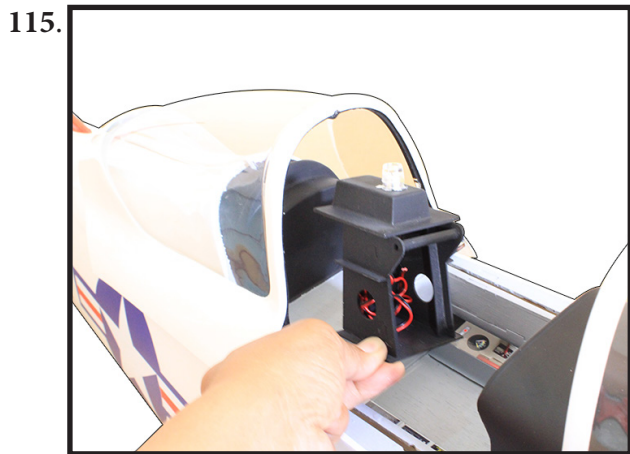
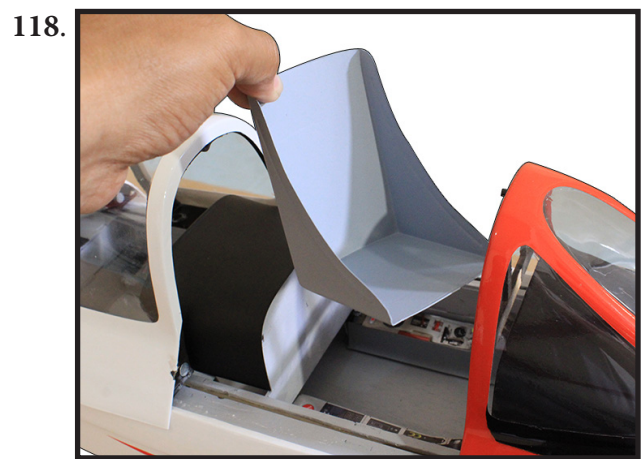
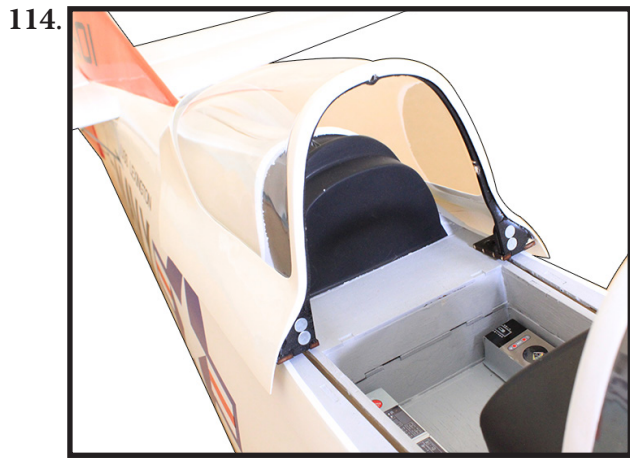

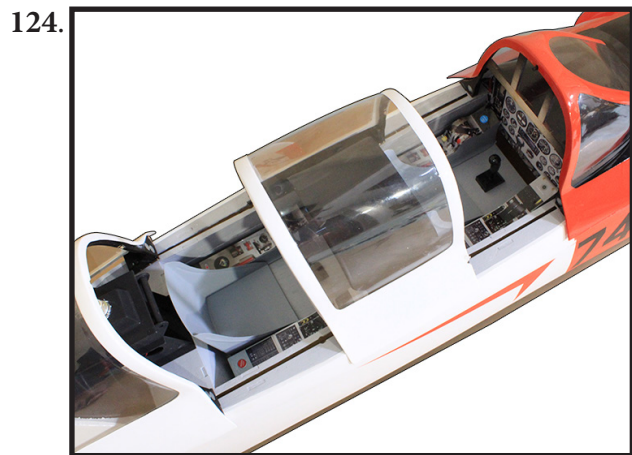
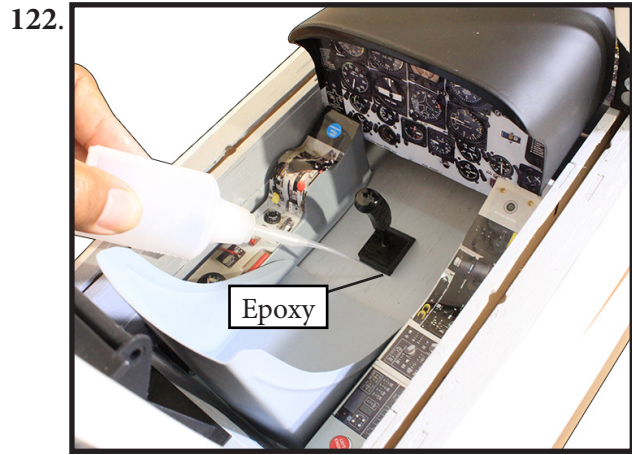

**INSTALL PLASTIC COVER ON THE TAIL**

Please study images below.

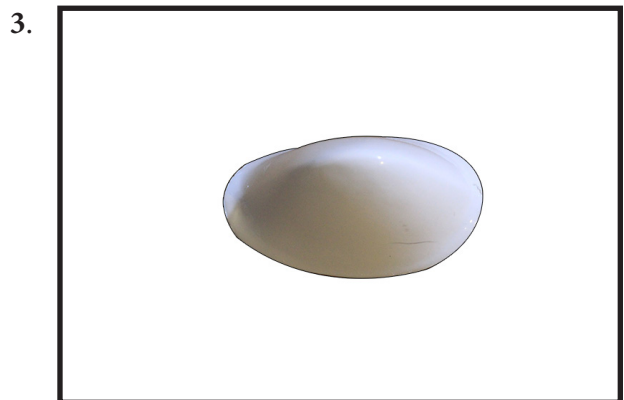
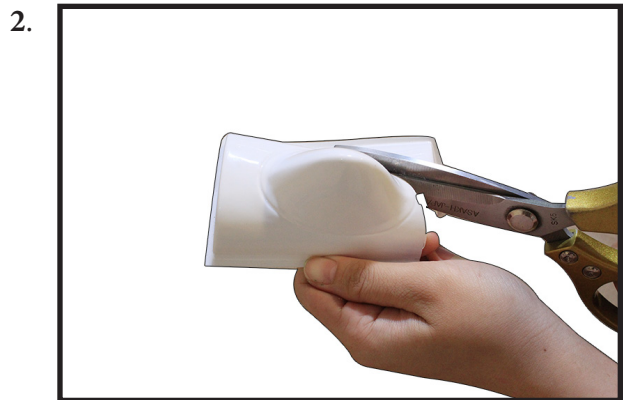
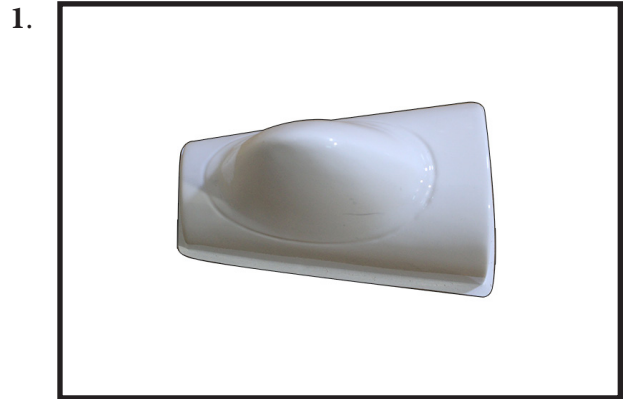



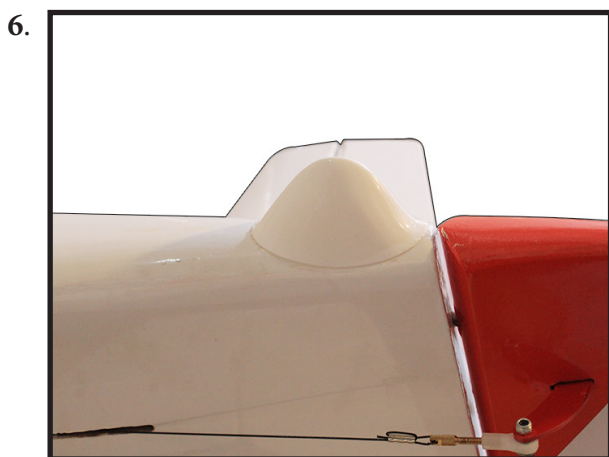
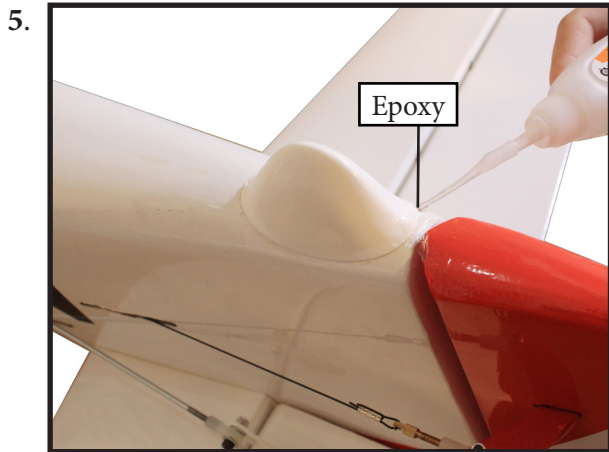

### APPLYING DECALS

Please use scissors and/or a hobby knife to cut the decals from the sheet. Please be certain the model is clean and free from oily fingerprints and dust. Position decal on the model where desired. You may use the photos on the box and/or online images to aid in their location and application.

If using custom decals, please follow manufacturers instructions to install those decals. Please be certain the model is clean and free from oily fingerprints and dust. Position decal on the model where desired, using images of appropriate artwork/photos to aid in their location.

### BALANCING - DO NOT SKIP THIS !

It is **critical** that your airplane be balanced correctly. Improper balance will cause your plane to lose control and crash. **THE CENTER OF GRAVITY IS LOCATED 135-150MM BACK FROM THE LEADING EDGE OF THE WING AT THE WING ROOT.**

Landing gear should be in the “up” retracted position when balancing.

Mount the wing to the fuselage. Place a piece of masking tape on the top of each wing **135-150MM** back from the leading edge at the wing root.

With the model inverted, place your fingers on the masking tape and carefully lift the plane. This is the point at which your model should balance for your first flights. Later, you may wish to experiment by shifting the balance up to 10mm forward or back to change the flying characteristics. Moving the balance forward may improve the smoothness and arrow-like tracking, but it may then require more speed for take off and make it more difficult to slow down for landing. Moving the balance aft makes the model more agile with a lighter and snappier “feel”. In any case, please start at the location we recommend.

\* If possible, first attempt to balance the model by changing the position of the receiver battery and receiver. If you are unable to obtain good balance by doing so, then it will be necessary to add weight to the nose or tail to achieve the proper balance point.

With the wings attached to the fuselage, all parts of the model installed ( ready to fly), and empty fuel tanks, hold the model at the marked balance point with the stabilizer level.

Lift the model. If the tail drops when you lift, the model is "tail heavy" and you must add weight\* to the nose. If the nose drops, it is "nose heavy" and you must add weight\* to the tail to balance.

1.

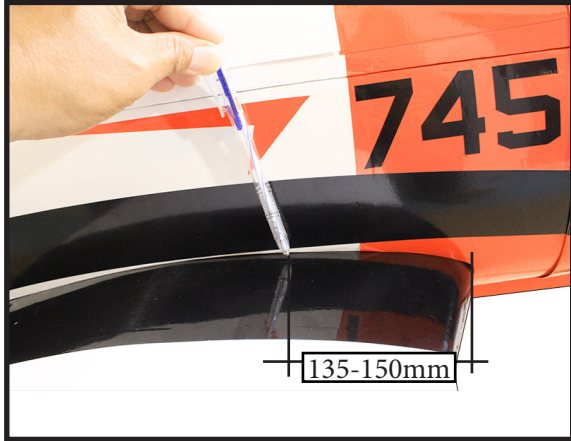

**CONTROL THROWS**

<b>Ailerons:</b>	<b>Rudder:</b>
High Rate :	High Rate :
Up : 15 mm	Right : 20 mm
Down : 15 mm	Left : 20 mm
Low Rate :	Low Rate :
Up : 12 mm	Right : 15 mm
Down : 12 mm	Left : 15 mm
<b>Elevator:</b>	<b>Flap:</b>
High Rate :	Mid : 50mm
Up : 15 mm	Full : 60mm
Down : 15 mm	
Low Rate :	
Up : 12 mm	
Down : 12 mm	

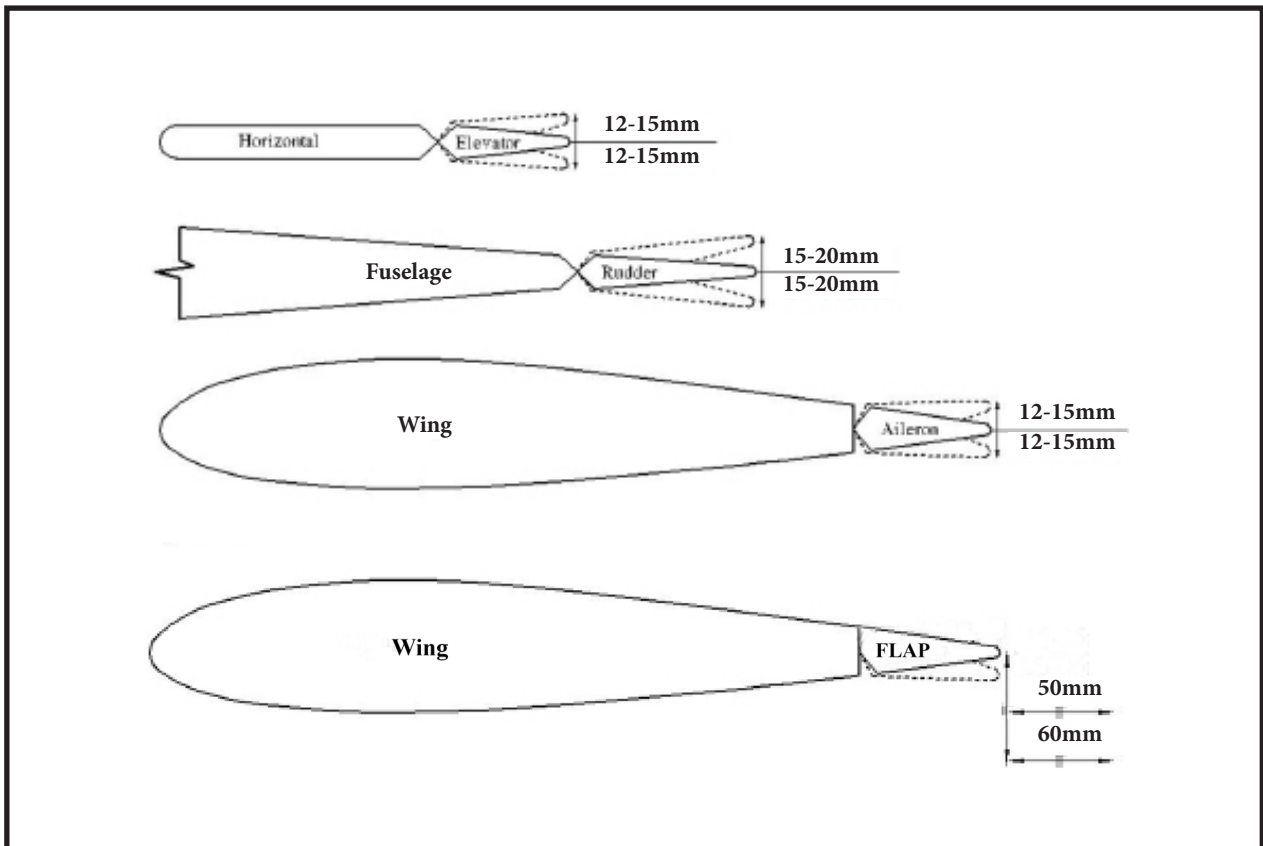



## FLIGHT PREPARATION

Check the operation and direction of the elevator, rudder, ailerons and throttle.

A) Plug in your radio system per the manufacturer's instructions and turn everything on.

B) Check the elevator first. Pull back on the elevator stick. The elevator halves should move up. If they do not, flip the servo reversing switch on your transmitter to change the direction.

C) Check the rudder. Looking from behind the airplane, move the rudder stick to the right. The rudder should move to the right. If it does not, flip the servo reversing switch on your transmitter to change the direction.

D) Check the throttle. Moving the throttle stick forward should open the carburetor barrel. If it does not, flip the servo reversing switch on your transmitter to change the direction.

E) From behind the airplane, look at the aileron on the right wing half. Move the aileron stick to the right. The right aileron should move up and the other aileron should move down. If it does not, flip the servo reversing switch on your transmitter to change the direction.

## PREFLIGHT CHECK

1) Completely charge your transmitter and receiver batteries before your first day of flying.

2) Check every bolt and every glue joint in the **1/6 Giant Scale North American T-28 82.5" ARF 35-60cc** to ensure that everything is tight and well bonded.

3) Double check the balance of the airplane. Do this with the fuel tank empty.

4) Check the control surfaces. All should move in the correct direction and not bind in any way.

5) If your radio transmitter is equipped with dual rate switches double check that they are on the low rate setting for your first few flights.

6) Check to ensure the control surfaces are moving the proper amount for both low and high rate settings.

7) Check the receiver antenna. It should be fully extended and not coiled up inside the fuselage.

8) Properly balance the propeller. An out of balance propeller will cause excessive vibration which could lead to engine and/or airframe failure.

*We wish you many safe and enjoyable flights*  
**with your 1/6 Giant Scale North American T-28 82.5" ARF 35-60cc.**

*If you have any queries, or are interested in our products,  
please feel free to contact us*

**Factory :** 12/101A - Hamlet 4 - Le Van Khuong Street - Dong Thanh Ward -  
Hoc Mon District - Ho Chi Minh City - Viet Nam.

**Office :** 62/8 Ngo Tat To Street - Ward 19 - Binh Thanh District - Ho Chi Minh  
City - Viet Nam

**Phone :** 848 - 86622289 or 848- 36018777

**Website :** [www.SeagullModels.com](http://www.SeagullModels.com)

**Email :** [Sales@seagullmodels.com](mailto:Sales@seagullmodels.com)

**Facebook :** [www.facebook.com/SeaGullModels](http://www.facebook.com/SeaGullModels).