



**INTRODUCTION.**

Thank you for choosing the **CHRISTEN HUSKY** ARTF by SEAGULL MODELS COMPANY LTD. The **CHRISTEN HUSKY** was designed with the intermediate/advanced sport flyer in mind. It is a semi scale airplane which is easy to fly and quick to assemble. The airframe is conventionally built using balsa, plywood to make it stronger than the average ARTF , yet the design allows the aeroplane to be kept light. You will find that most of the work has been done for you already. The motor mount has been fitted and the hinges are pre-installed . Flying the **CHRISTEN HUSKY** is simply a joy.

This instruction manual is designed to help you build a great flying aeroplane. Please read this manual thoroughly before starting assembly of your **CHRISTEN HUSKY** . Use the parts listing below to identify all parts.

**WARNING.**

*Please be aware that this aeroplane is not a toy and if assembled or used incorrectly it is capable of causing injury to people or property. WHEN YOU FLY THIS AEROPLANE YOU ASSUME ALL RISK & RESPONSIBILITY.*

If you are inexperienced with basic R/C flight we strongly recommend you contact your R/C supplier and join your local R/C Model Flying Club. R/C Model Flying Clubs offer a variety of training procedures designed to help the new pilot on his way to successful R/C flight. They will also be able to advise on any insurance and safety regulations that may apply.

**KIT CONTENTS**







**HINGING THE ELEVATORS**

1) Locate the items for this section of the manual.

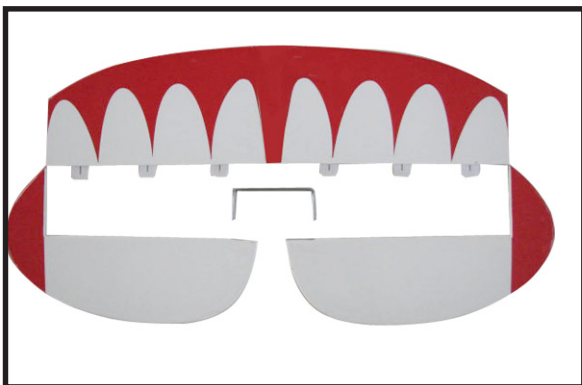

2) Carefully remove the elevator from one of the horizontal stabilizer panels. Note the position of the hinges. Used C/A glue to fix the hinges position..

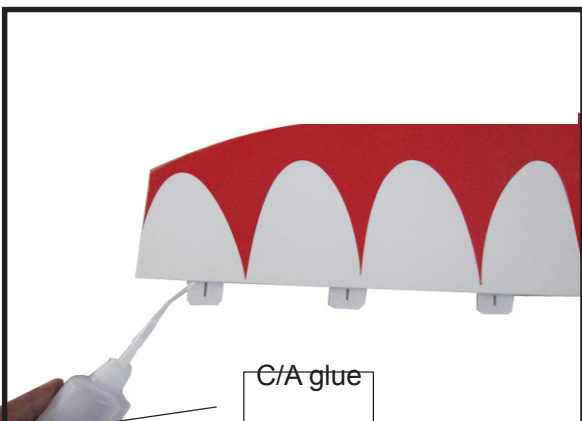
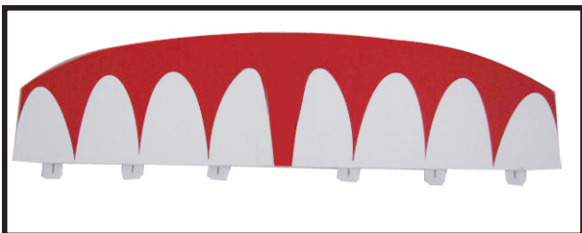

3) Remove each hinge from the horizontal stabilizer panel and elevator and place a T-pin in the center of each hinge. Slide each hinge into the elevator until the T-pin is snug against the elevator. This will help ensure an equal amount of hinge is on either side of the hinge line when the elevator is mounted to the horizontal stabilizer panel.

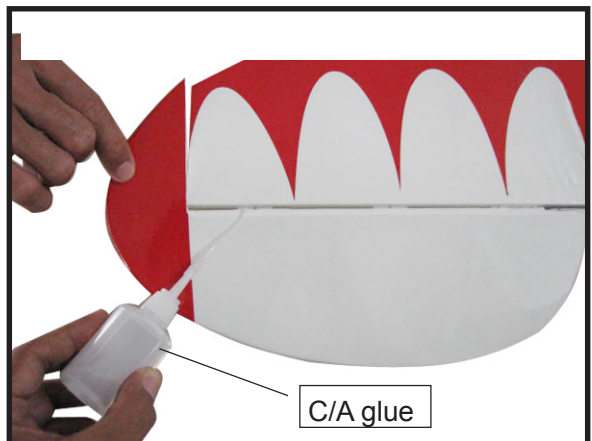
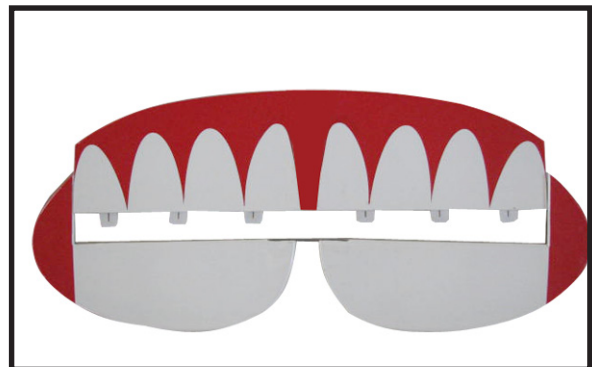
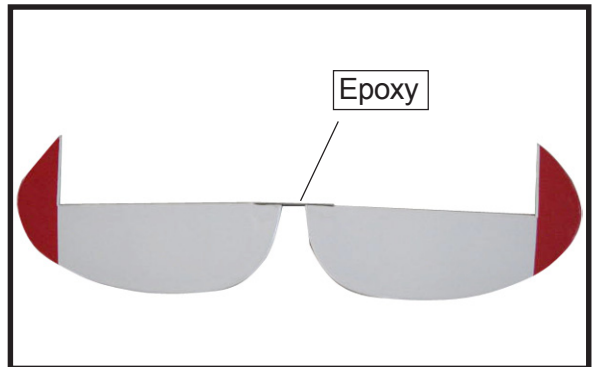
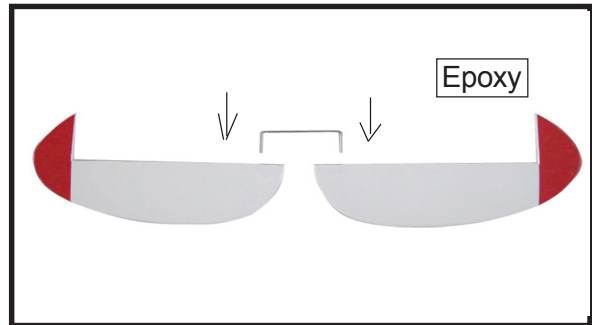

### HINGING THE RUDDER

Glue the rudder hinges in place using the same techniques used to hinge the ailerons.



### INSTALL THE .

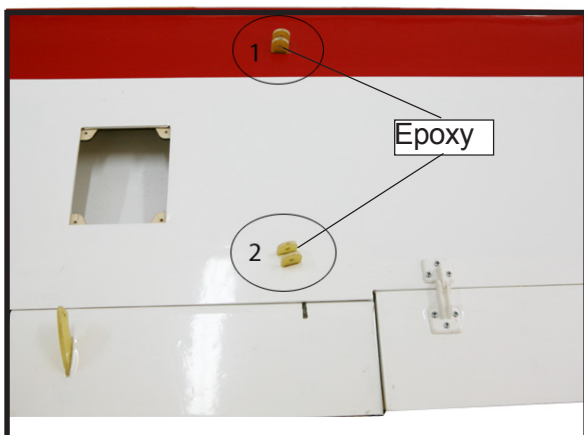
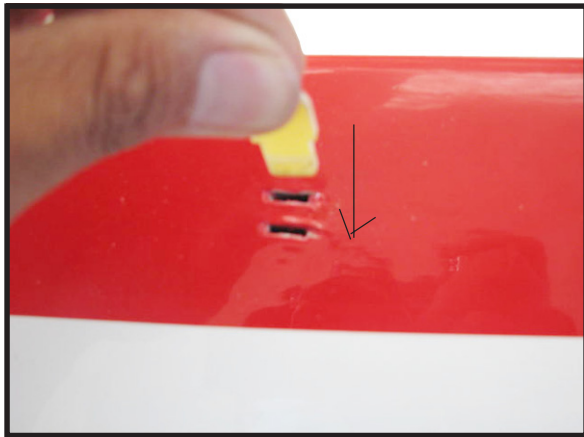
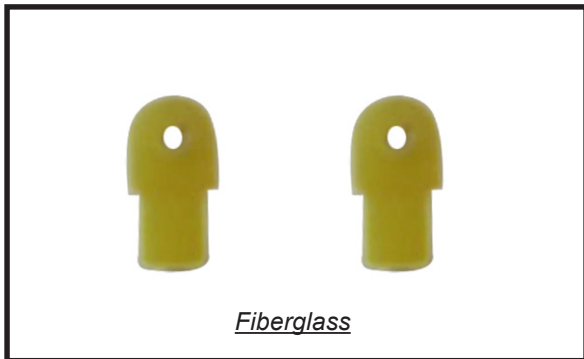

### INSTALL THE AILERONS CONTROL HORN.

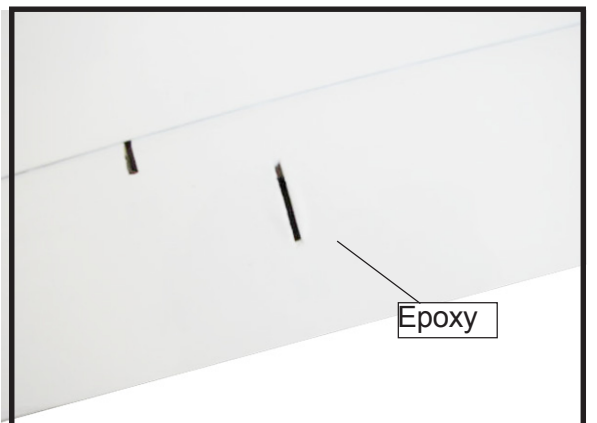

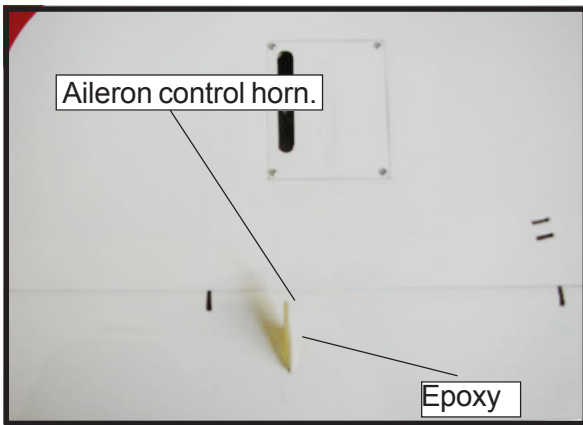

**INSTALL ELEVATOR CONTROL HORN.**

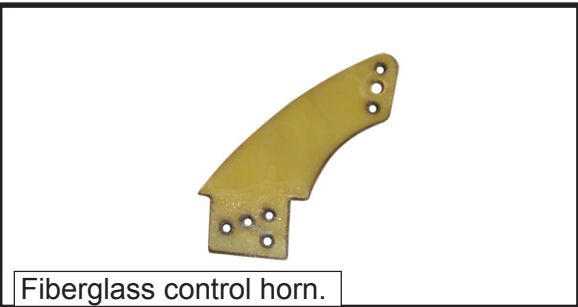

**INSTALL FLAP CONTROL HORN.**

Install the flap control horn using the same method as same as the aileron control horns.

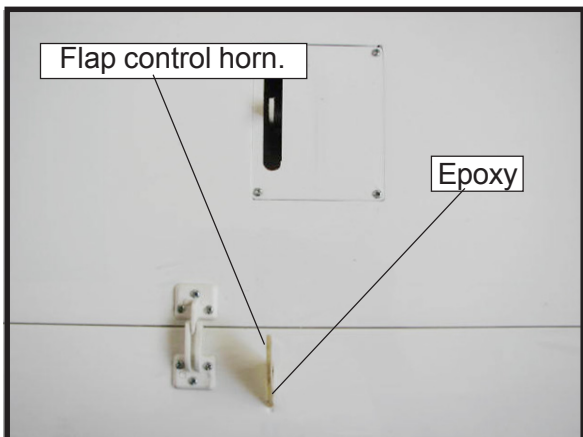
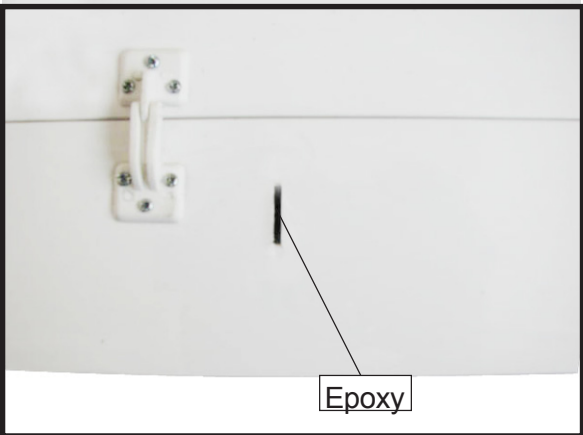

**INSTALL RUDDER CONTROL HORN.**

Repeat steps to install the rudder control horn as same as steps done for ailerons.



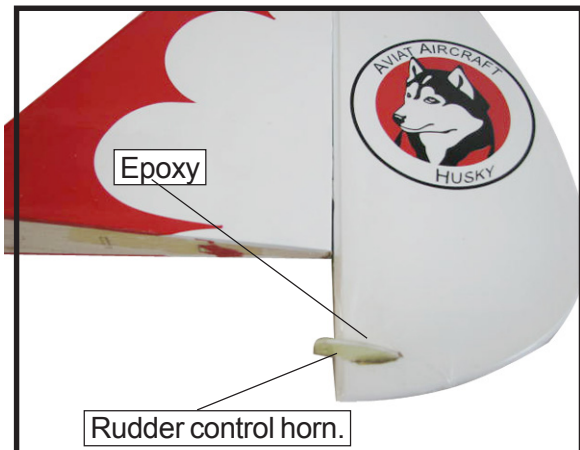

**WHEEL AND WHEEL PANTS.**

1) Assembling and mounting the wheel pants as shown below pictures.

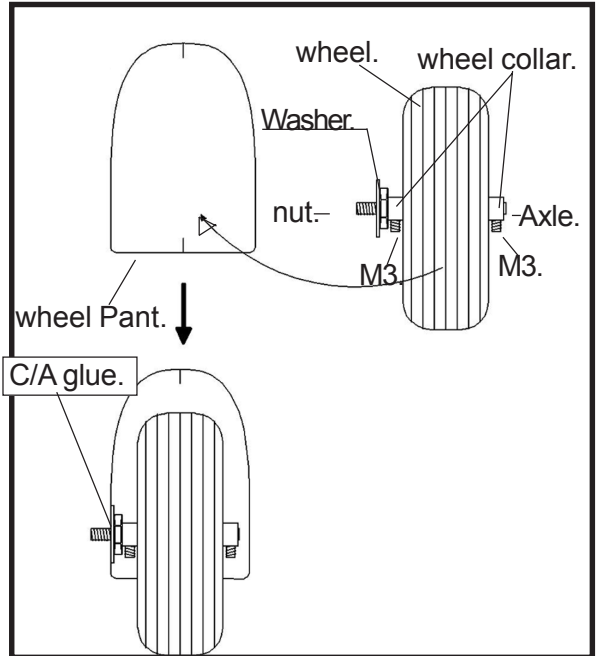
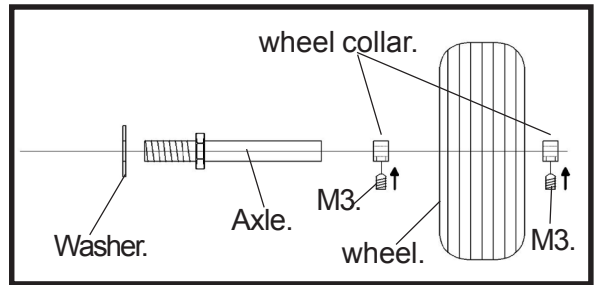
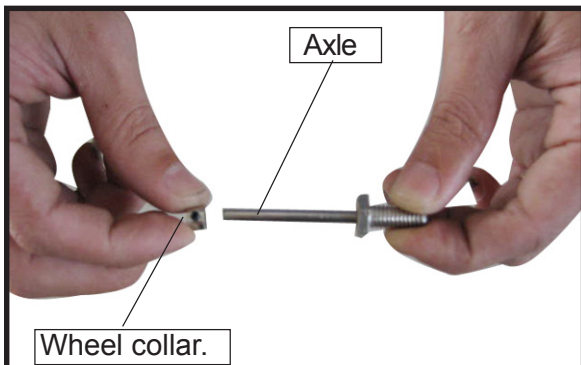

**INSTALLING THE MAIN LANDING GEAR TO FUSELAGE.**



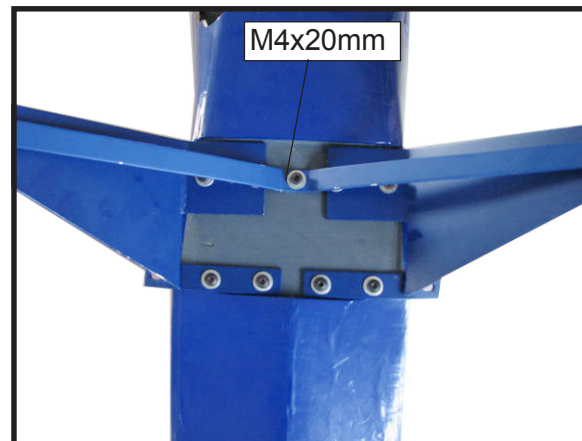
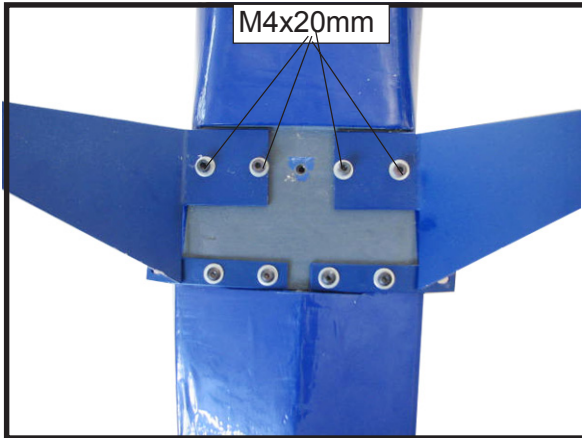
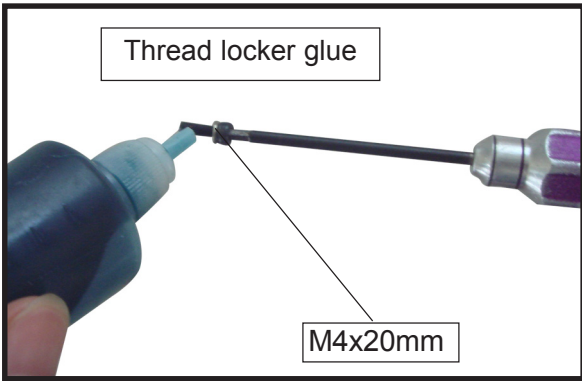

**INSTALLING WHEEL PANTS TO MAIN LADING GEAR.**

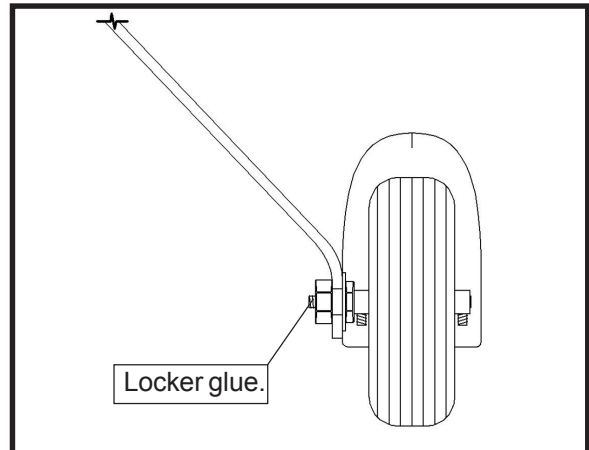
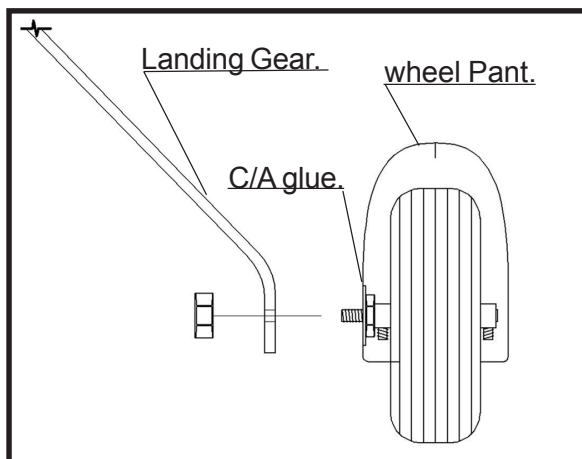

**ENGINE MOUNT INSTALLATION.**

1) Locate the items necessary to install the engine mount included with your model. .

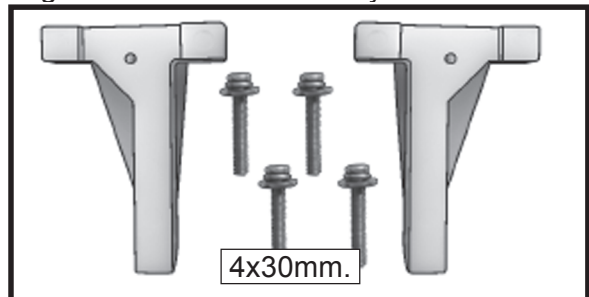

2) Use four 4x30mm head bolts and four 4mm washers to attach the engine mount rails to the firewall. Tighten the screws . Make sure to use threadlock on the screws to help prevent them from vibrating loose.





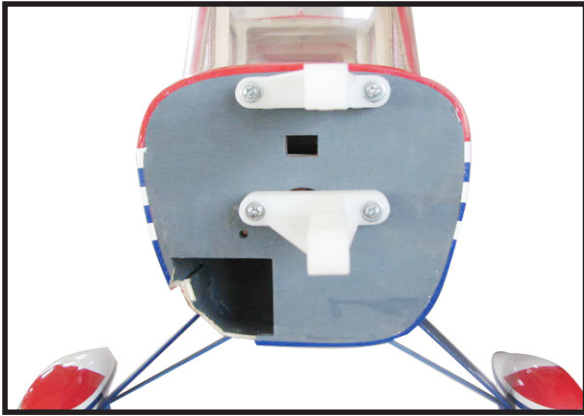

**INSTALLING THE STOPPER ASSEMBLY.**

- 1) Using a modeling knife, carefully cut off the rear portion of one of the 3 nylon tubes leaving 1/2" protruding from the rear of the stopper. This will be the fuel pick up tube.
- 2) Using a modeling knife, cut one length of silicon fuel line. Connect one end of the line to the weighted fuel pick up and the other end to the nylon pick up tube.

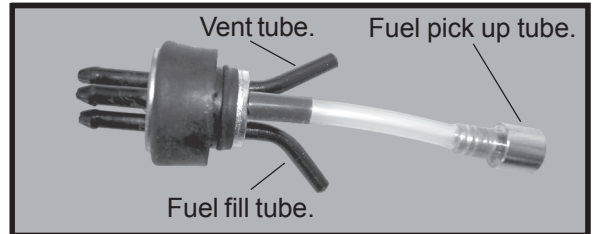
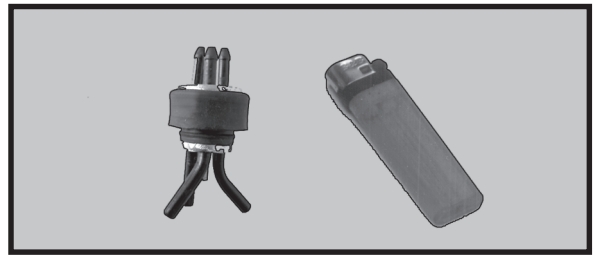
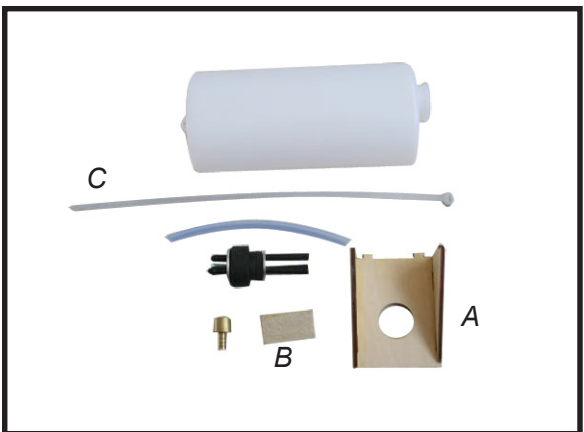
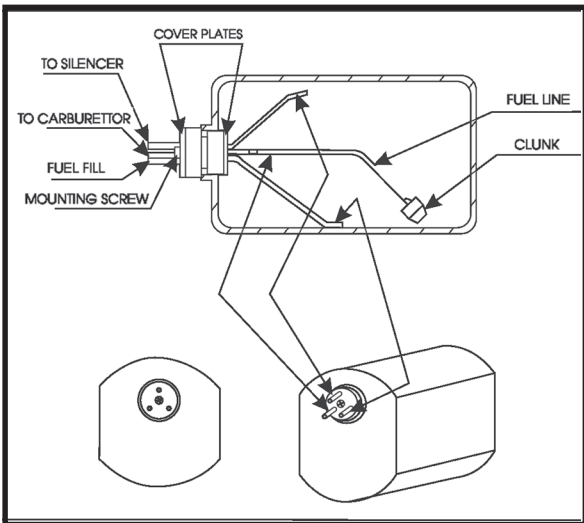

- 3) Carefully bend the second nylon tube up at a 45° angle. This tube is the vent tube.
- 4) Test fit the stopper assembly into the tank. It may be necessary to remove some of the flashing around the tank opening using a modeling knife. If flashing is present, make sure none falls into the tank.
- 5) With the stopper assembly in place, the weighted pick-up should rest away from the rear of the tank and move freely inside the tank. The top of the vent tube should rest just below the top of the tank. It should not touch the top of the tank.
- 6) When satisfied with the alignment of the stopper assembly tighten the 3 x 20mm machine screw until the rubber stopper expands and seals the tank opening. Do not overtighten the assembly as this could cause the tank to split.

**FUEL TANK INSTALLATION.**

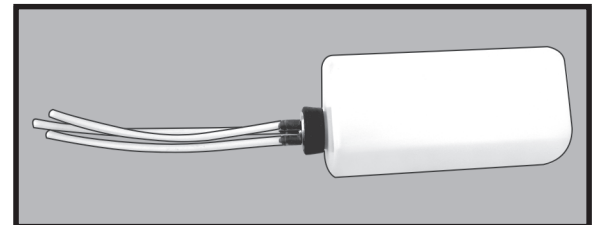

*You should mark which tube is the vent and which is the fuel pickup when you attach fuel tubing to the tubes in the stopper. Once the tank is installed inside the fuselage, it may be difficult to determine which is which.*

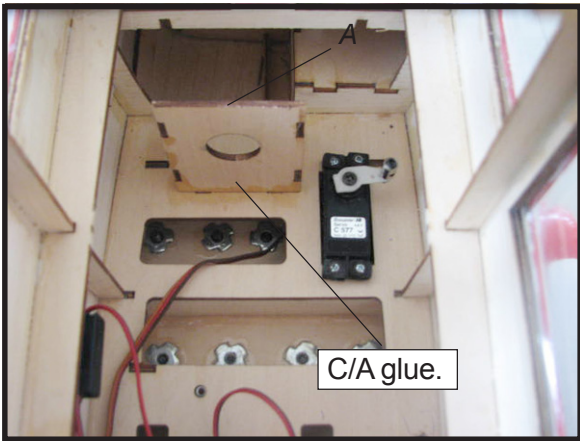

☐ 7) Slide the fuel tank into the fuselage. Guide the lines from the tank through the hole in the firewall.

☐ 8) Use plywood template to hold in place the fuel tank with C/A glue to secure the fuel tank inside the fuselage.

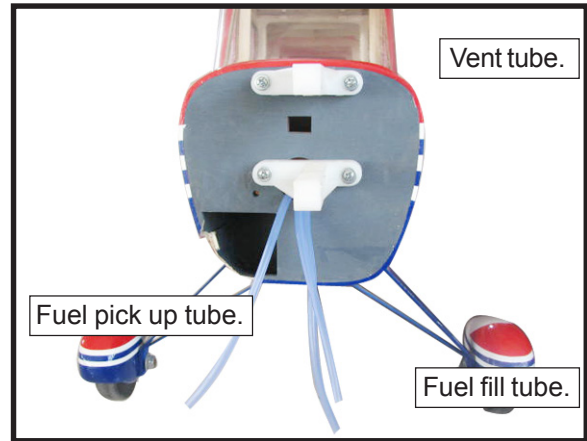
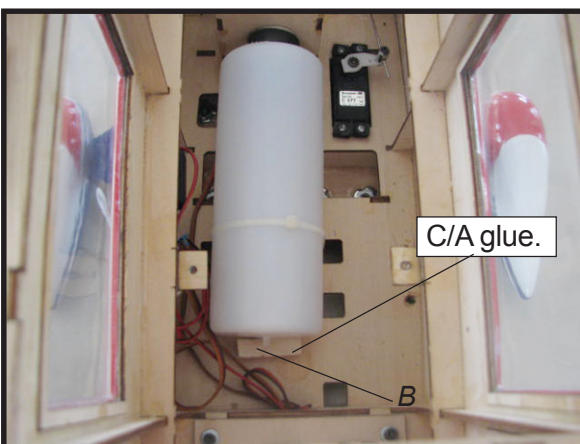
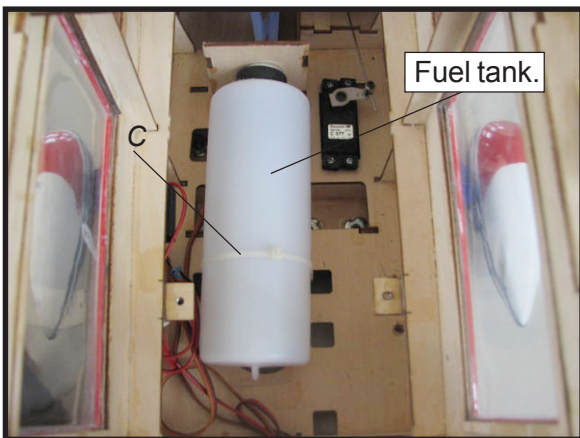

9) Connect the lines from the tank to the engine and muffler. The vent line will connect to the muffler and the line from the clunk to the carburetor.



⚠ **Blow through one of the lines to ensure the fuel lines have not become kinked inside the fuel tank compartment. Air should flow through easily.**

**INSTALLING THE FUSELAGE SERVOS.**

⚠ Because the size of servos differ, you may need to adjust the size of the precut opening in the mount. The notch in the sides of the mount allow the servo lead to pass through.

☐ 1) Install the rubber grommets and brass collets onto the throttle servo. Test fit the servo into the aileron servo mount.

☐ 2) Secure the servos with the screws provided with your radio system.

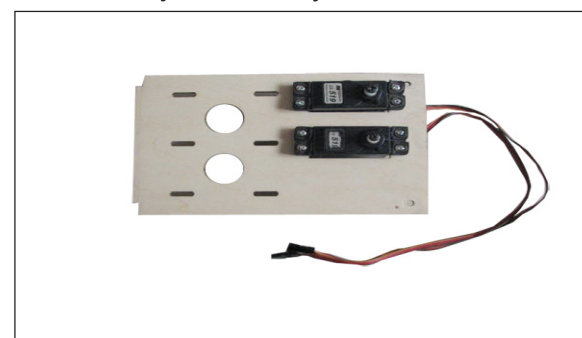

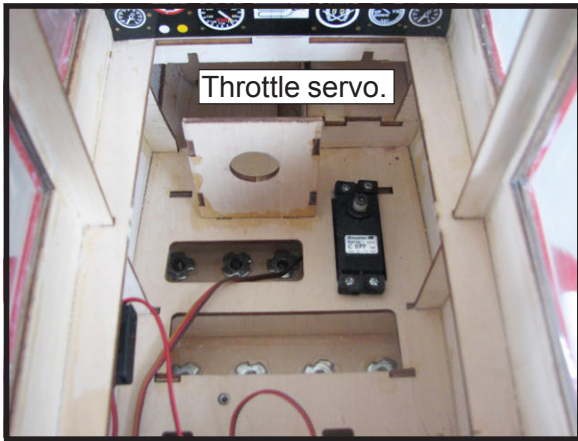

### THROTTLE SERVO ARM INSTALLATION.

Install adjustable servo connector in the servo arm as same as picture below:

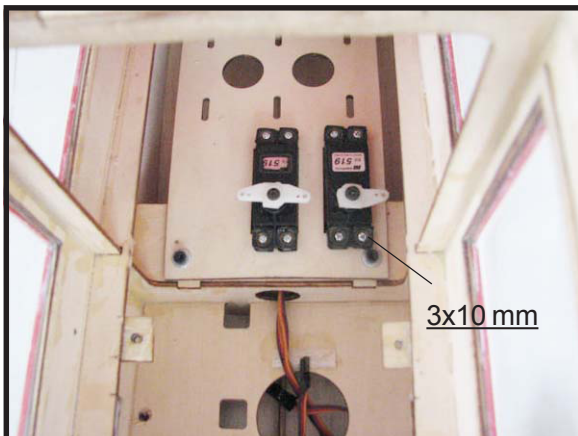
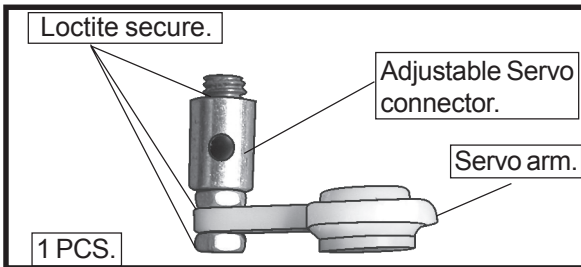

### INSTALLING THE SWITCH.

Install the switch into the precut hole in the side, in the fuselage.

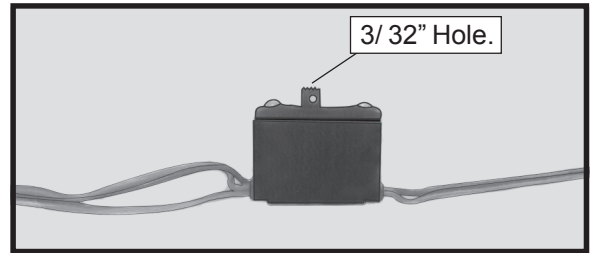

⚠️ *Recomend mounting switch inside fuselage if using floats.*



### MOUNTING THE ENGINE.

□ 1) Position the engine with the drive washer (145mm) forward of the firewall as shown.

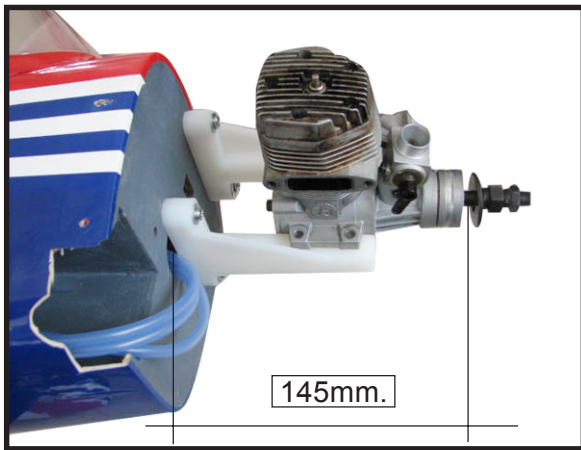

2) Use a pin drill and 4mm drill bit to drill a small indentation in the mount for the engine mounting screw.

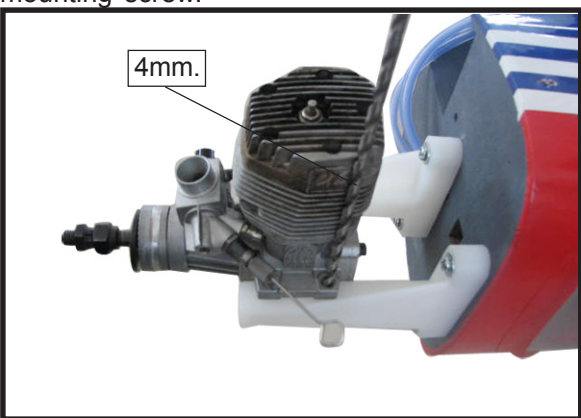

3) Use a drill to drill the four holes in the engine mount rails.

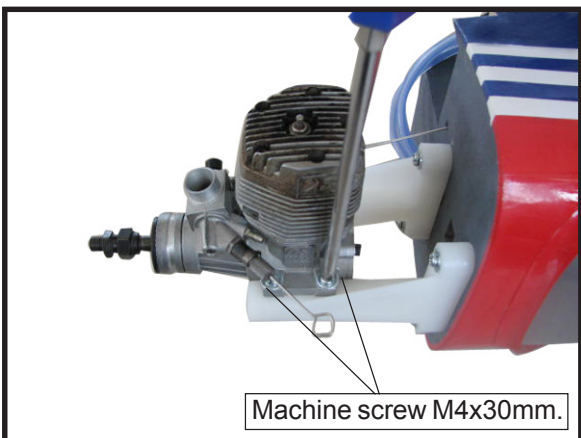
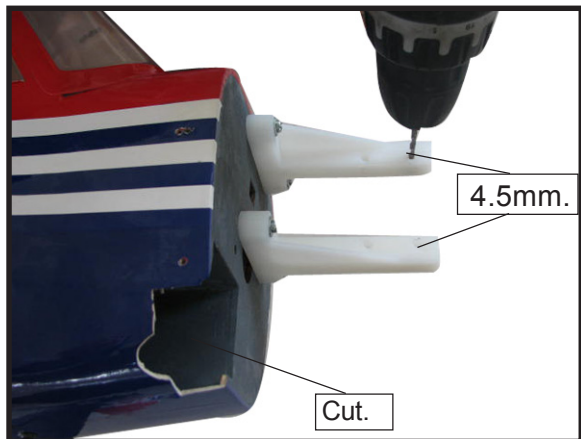

4) On the fire wall has the location for the throttle pushrod tube (pre-drill).

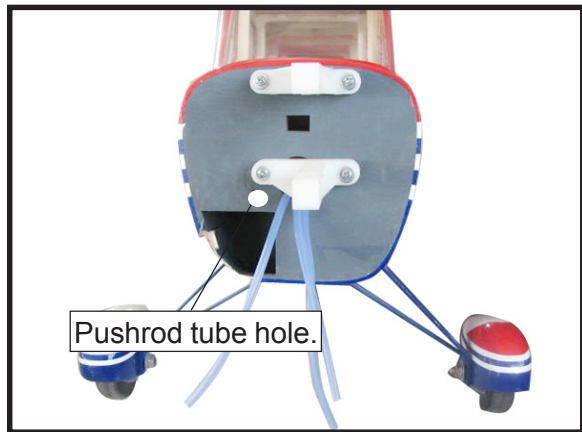

5) Slide the pushrod tube in the firewall and guide it through the fuel tank mount. Use medium C/A to glue the tube to the firewall and the fuel tank mount.

6) Connect the Z-bend in the 450mm throttle pushrod to the outer hole of the carburetor arm.

7) Slide the throttle pushrod wire into the tube. Position the engine between the mounts. Use four M4x30mm machine screws to secure the engine to the mount as shown.

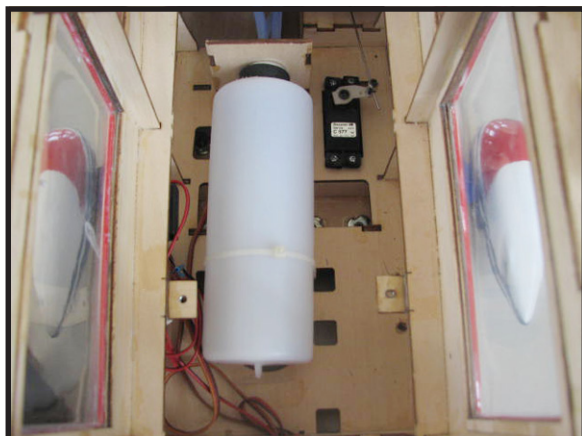
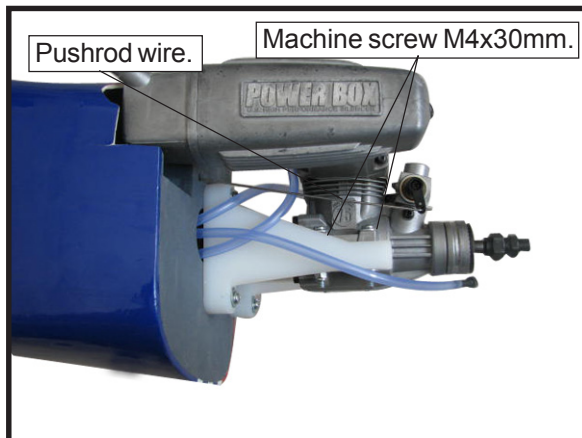

9) Move the throttle stick to the closed position and move the carburetor to closed. Use a 2.5mm hex wrench to tighten the screw that secures the throttle pushrod wire. Make sure to use threadlock on the screw so it does not vibrate loose.

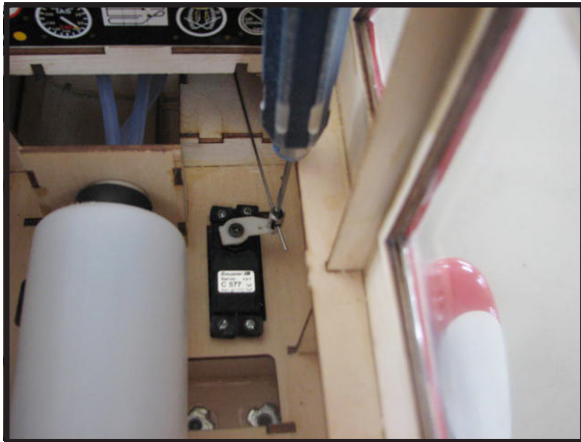

### COWLING.

□ 1) Slide the fiberglass cowl over the engine and line up the back edge of the cowl with the marks you made on the fuselage then trim and cut as shown.

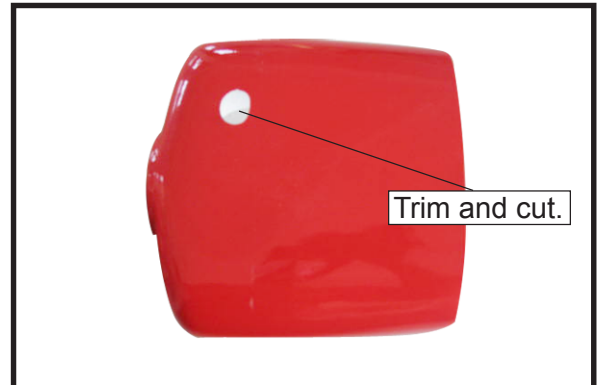
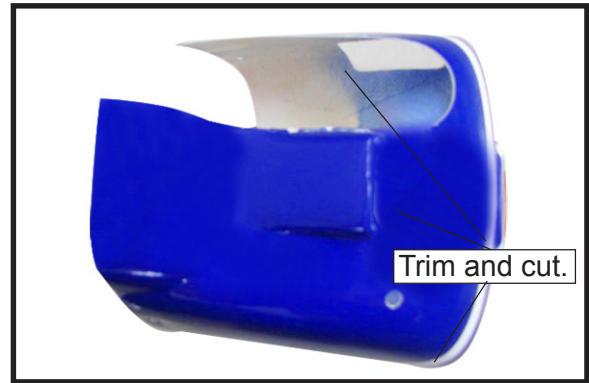
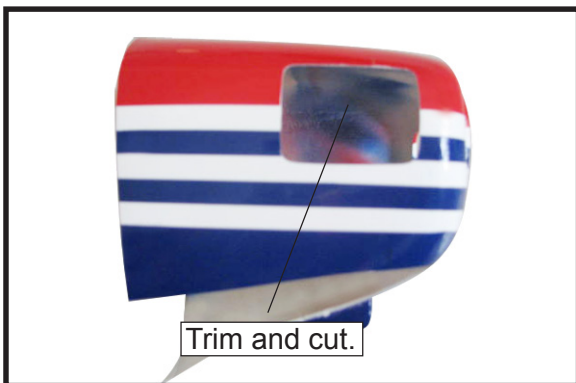

*Because of the size of the cowl, it may be necessary to use a needle valve extension for the high speed needle valve. Make this out of sufficient length 1.5mm wire and install it into the end of the needle valve. Secure the wire in place by tightening the set screw in the side of the needle valve.*

□ 2) While keeping the back edge of the cowl flush with the marks, align the front of the cowl with the crankshaft of the engine. The front of the cowl should be positioned so the crankshaft is in **nearly** the middle of the cowl opening. Use the spinner backplate as a guide. Hold the cowl firmly in place using pieces of masking tape.

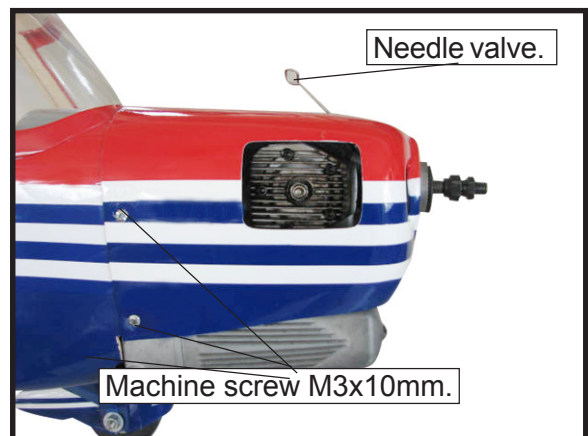



- Model size: .75-.90 size models
- Motor: 50mm 310 rev per volt
- Propeller: 14x10 ~ 15x10
- ESC: 60A
- Lipo Batteries: 8 cell 3200mA

2) Attach the electric motor box to the firewall suitable with the cross lines drawn on the electric motor box and firewall. Using epoxy and balsa stick to secure the motor box to the firewall. Please see pictures below.

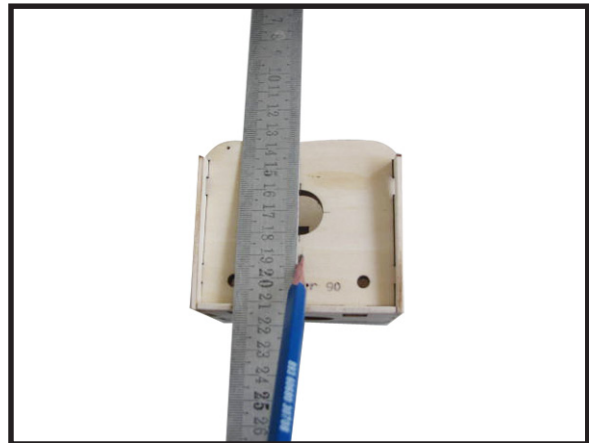

□ 3) Install the muffler and muffler extension onto the engine and make the cutout in the cowl for muffler clearance. Connect the fuel and pressure lines to the carburetor, muffler and fuel filler valve. Secure the cowl to fuselage using the M3x10mm screws.

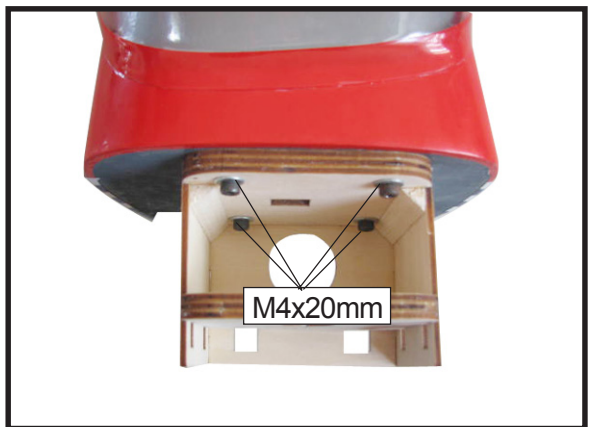

**ELECTRIC POWER CONVERSION.**

1) Locate the items necessary to install the electric power conversion included with your model.

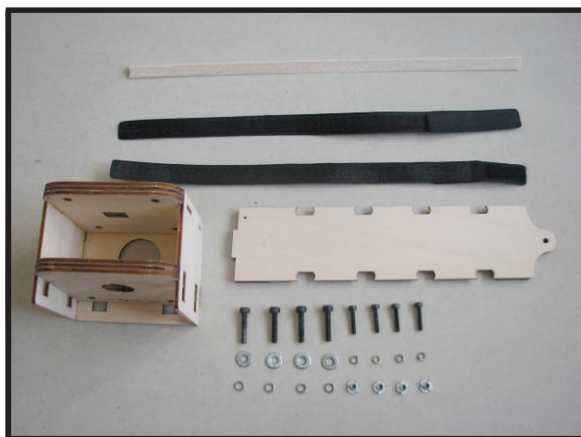

1) Recommendation EP parts as shown (not included with your model).

3) Attach the motor to the front of the electric motor box using four 4mm blind nut, four M3x15mm hex head bolts to secure the motor. Please see picture shown.



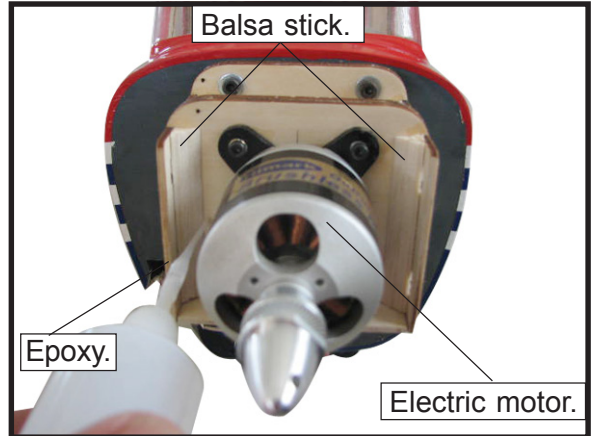
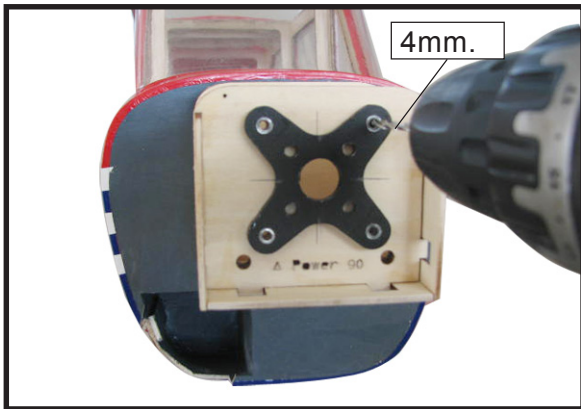
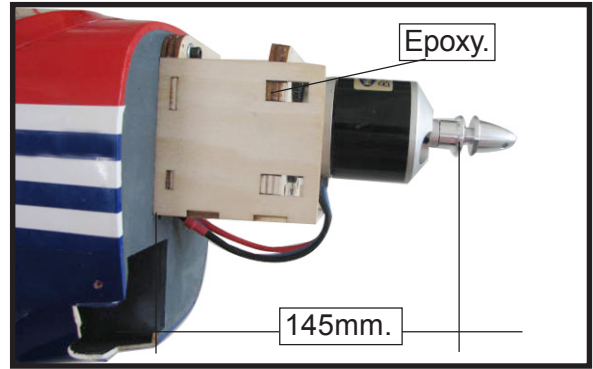
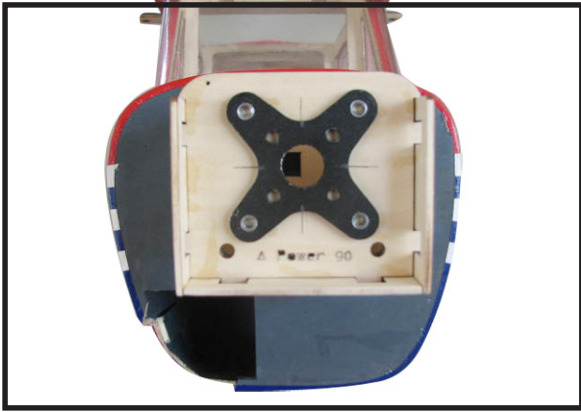

4) Locate the plywood battery tray to the fuselage. Tighten the screws using machine screws M3x15mm to secure the tray in position.

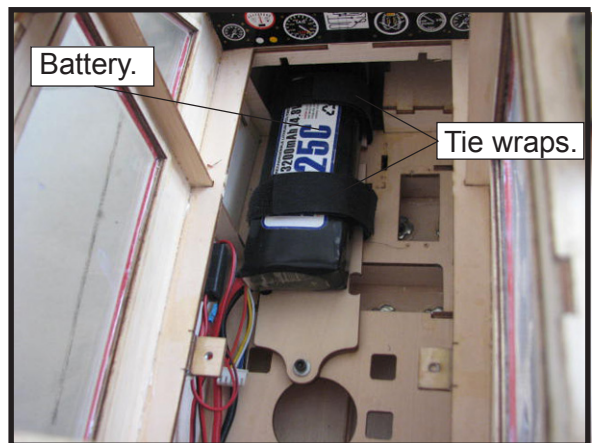
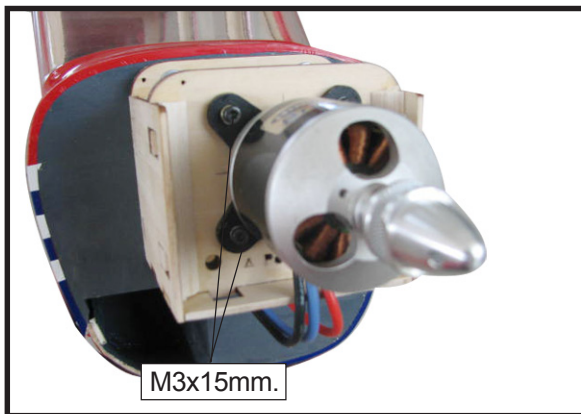
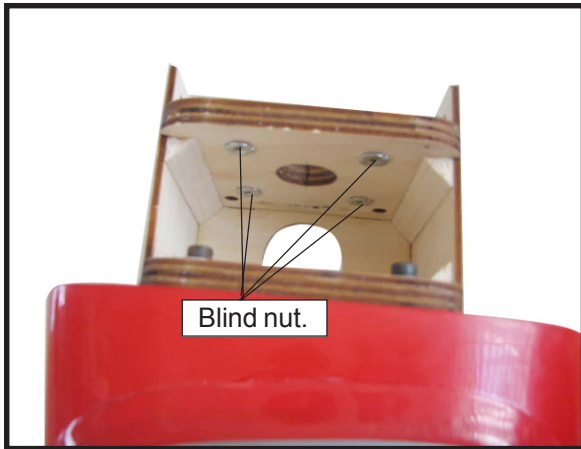

5) Attach the speed control to the side of the motor box using two-sided tape and tie wraps. Connect the appropriate leads from the speed control to the motor. Make sure the leads will not interfere with the operation of the motor.

 *Recomend Mounting Speed Control inside Fuselage If Flying off Water.*

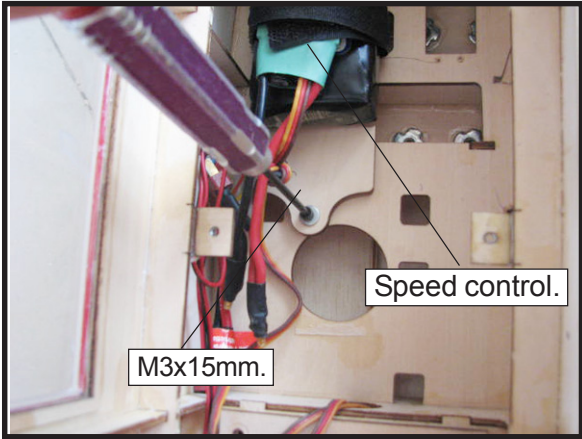

**INSTALLING THE SPINNER.**

Install the spinner backplate, propeller and spinner cone.



 *The propeller should not touch any part of the spinner cone. If it does, use a sharp modeling knife and carefully trim away the spinner cone where the propeller comes in contact with it.*



**INSTALLING THE AILERON - FLAP SERVOS.**

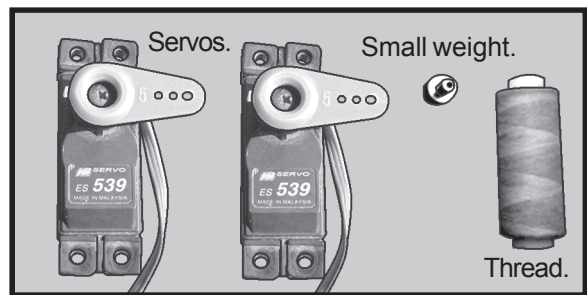
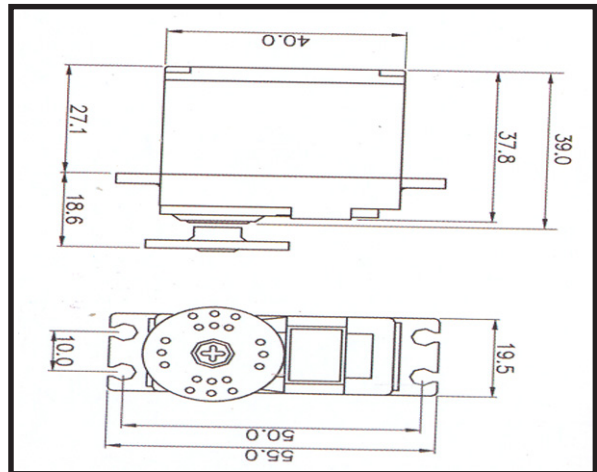

 *Because the size of servos differ, you may need to adjust the size of the precut opening in the mount. The notch in the sides of the mount allow the servo lead to pass through.*

- 1) Using a small weight (Weighted fuel pick-up works well) and string, feed the string through the wing as indicated.
- 2) Place the servo between the mounting blocks and space it from the hatch. Use a pencil to mark the mounting hole locations on the blocks.

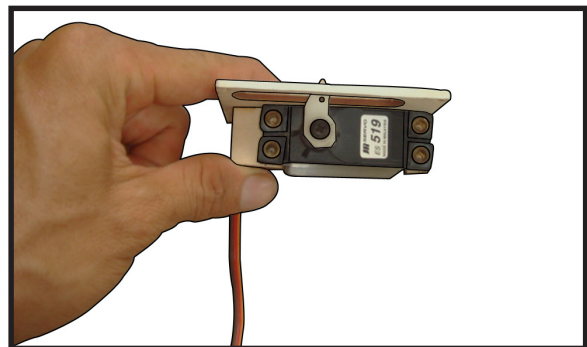

- 3) Use drill bit in a pin vise to drill the mouting holes in the blocks.



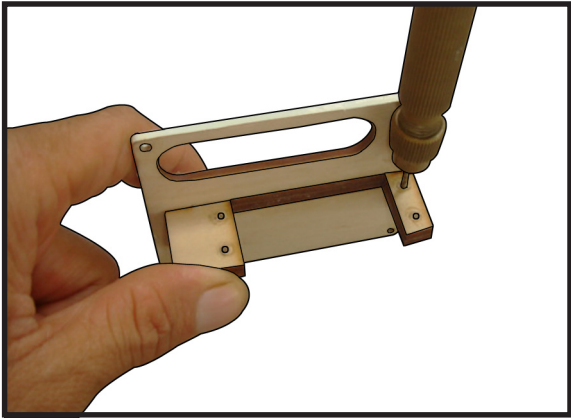

4) Apply 2-3 drops of thin C/A to each of the mounting holes. Allow the C/A to cure without using accelerator.

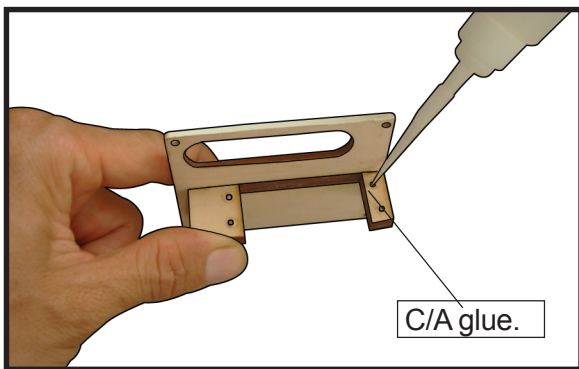

5) Use dental floss to secure the connection so they cannot become unplugged.

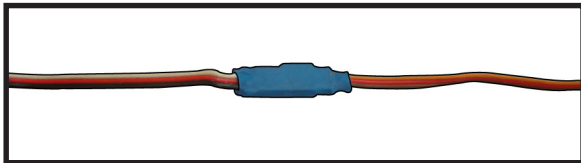

6) Secure the servo to the aileron hatch using Phillips screwdriver and the screws provided with the servo.

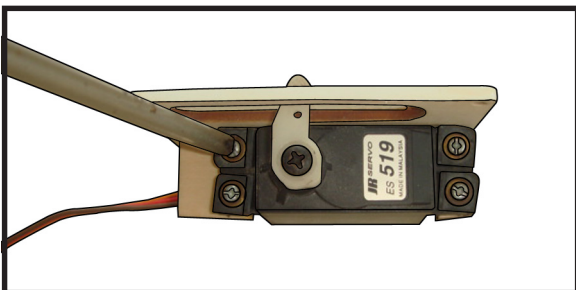

7) Apply 1-2 drops of thin C/A to each of the mounting tabs. Allow the C/A to cure without using accelerator.

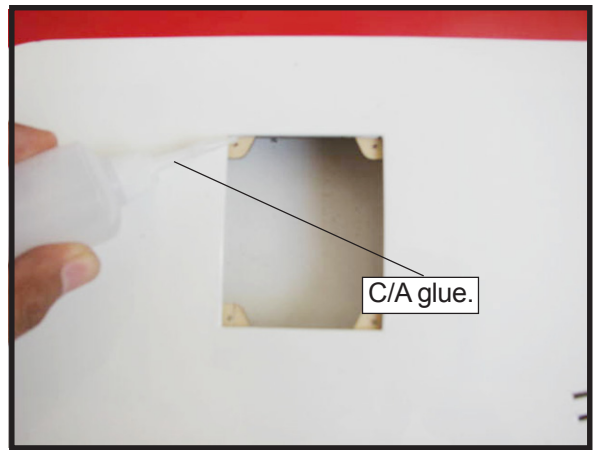

8) A string has been provided in the wing to pull the aileron lead through to the wing root. Remove the string from the wing at the servo location and use the tape to attach it to the servo extension lead. Pull the lead through the wing and remove the string.

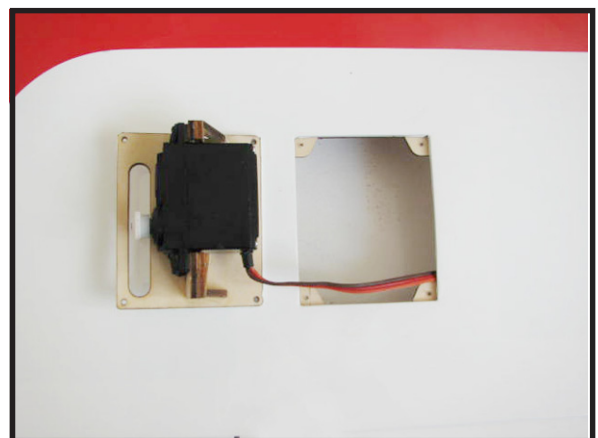
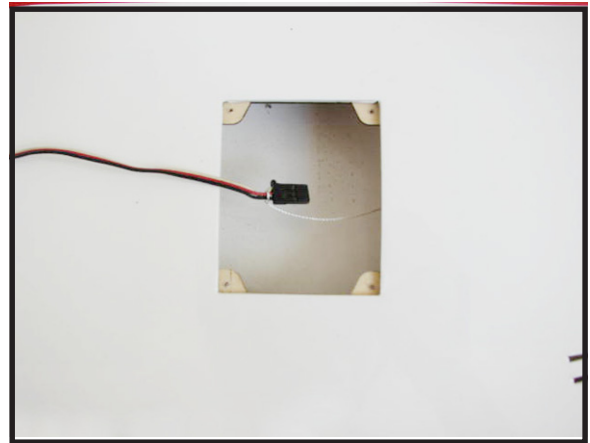

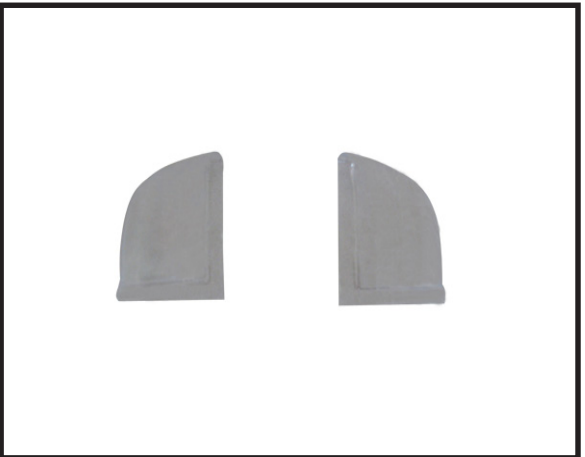
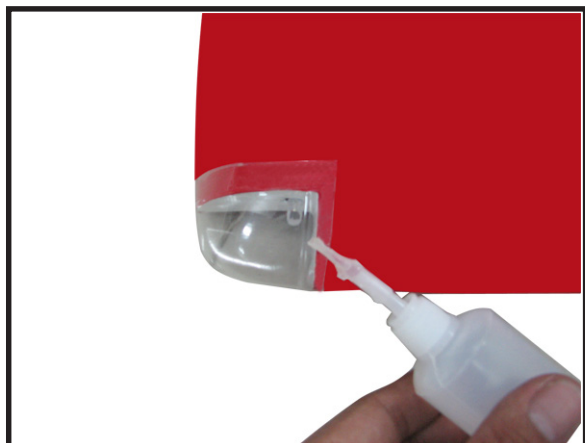
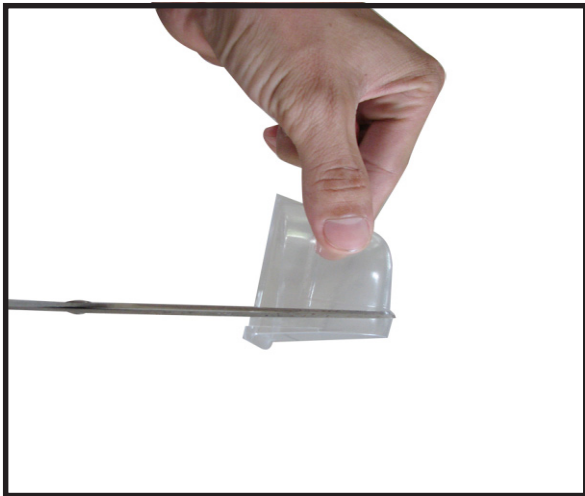
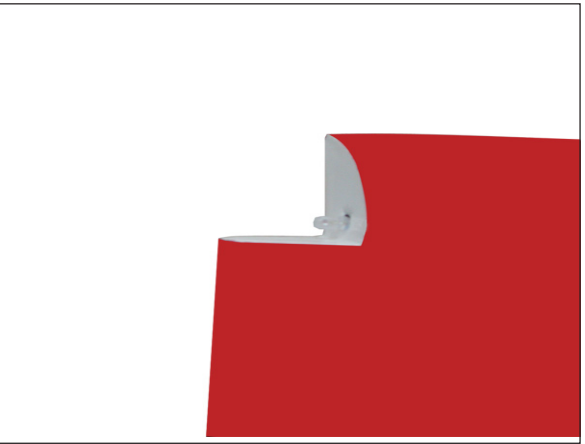
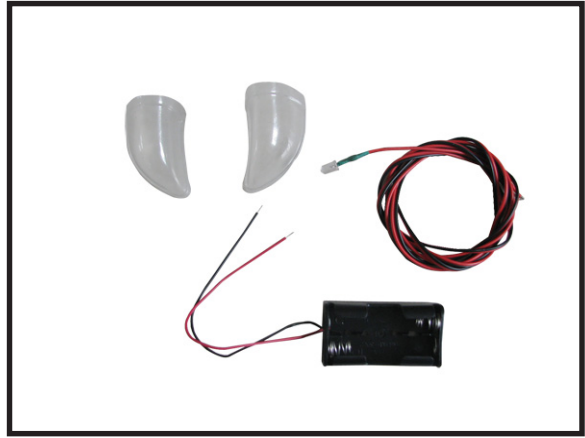
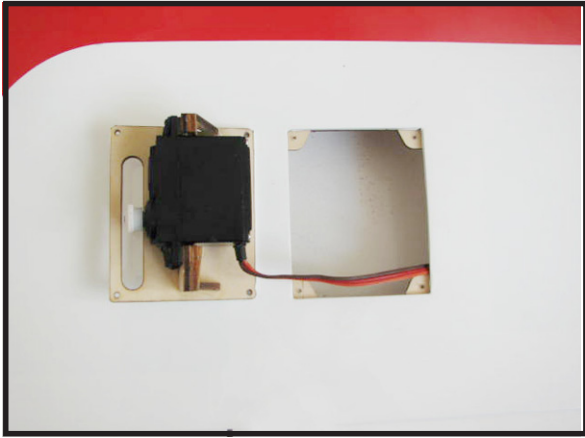

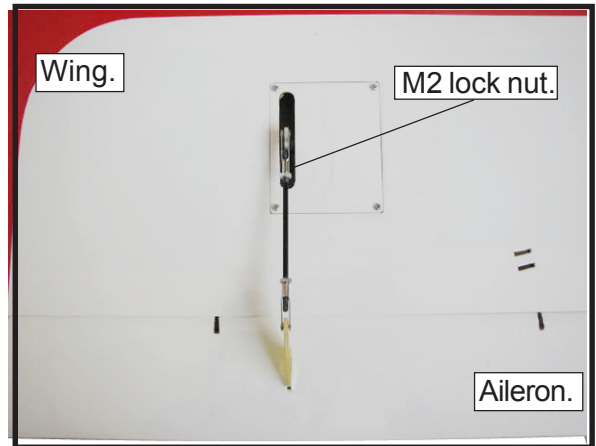
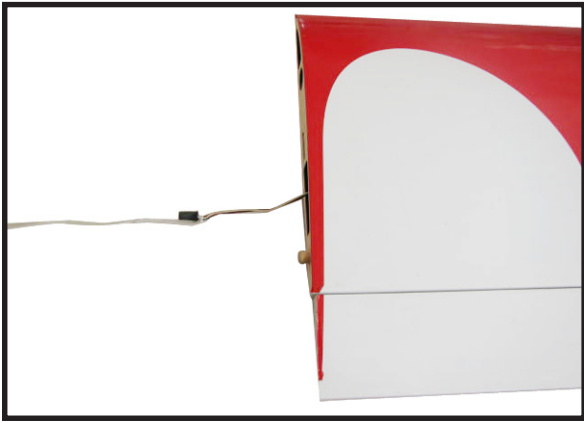

9) Set the aileron hatch in place and use a Phillips screw driver to install it with four wood screws.

**INSTALLING THE FLAP SERVO**

Repeat the procedure for the aileron servo.

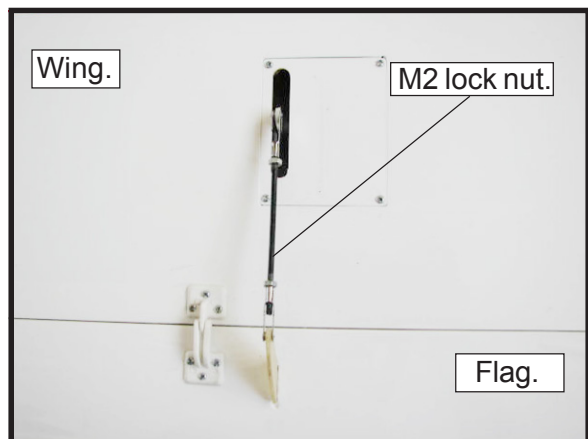
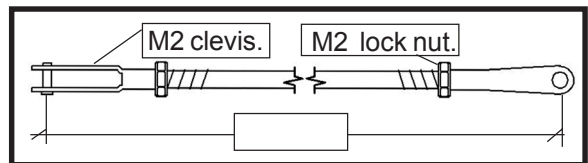
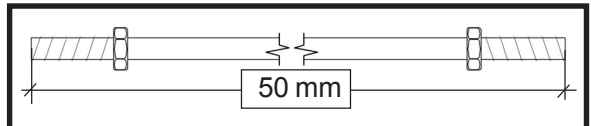
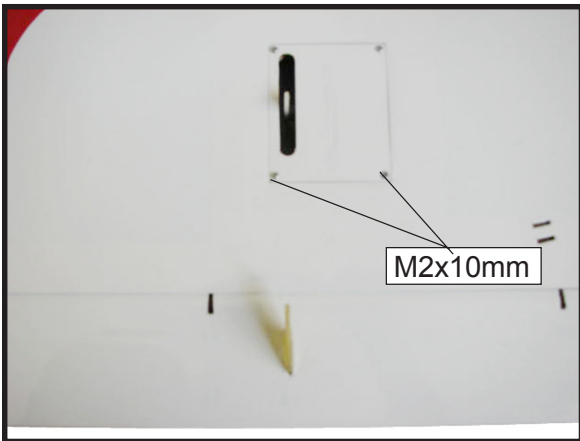

**AILERON PUSHROD HORN INSTALLATION**

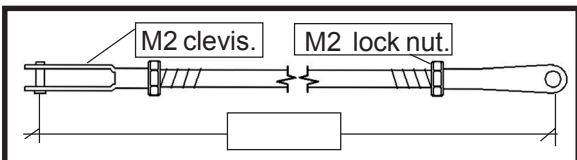
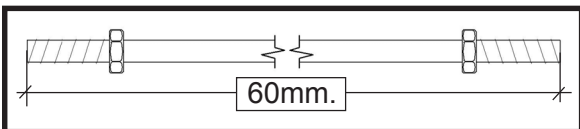

**INSTALLING THE HORIZONTAL STABILIZER.**

□ 1) Using a ruler and a pen, locate the centerline of the horizontal stabilizer, at the trailing edge, and place a mark. Use a triangle and extend this mark, from back to front, across the top of the stabilizer. Also extend this mark down the back of the trailing edge of the stabilizer.

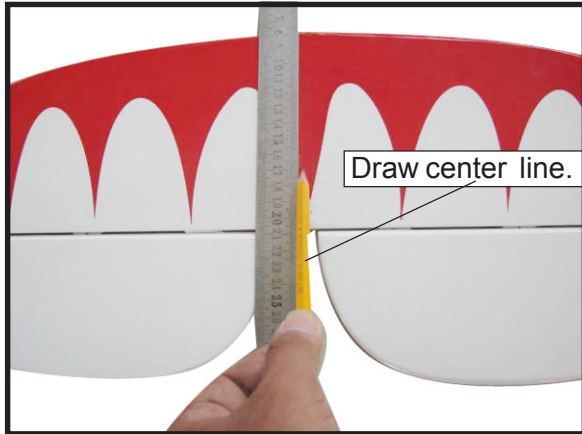

□ 2) Using a modeling knife, carefully remove the covering at mounting slot of horizontal stabilizer ( both side of fuselage).

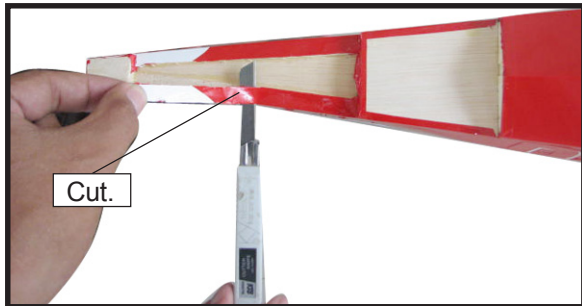

□ 3) Slide the stabilizer into place in the pre-cut slot in the rear of the fuselage. The stabilizer should be pushed firmly against the front of the slot.



□ 4) With the stabilizer held firmly in place, use a pen and draw lines onto the stabilizer where it and the fuselage sides meet. Do this on both the right and left sides and top and bottom of the stabilizer.

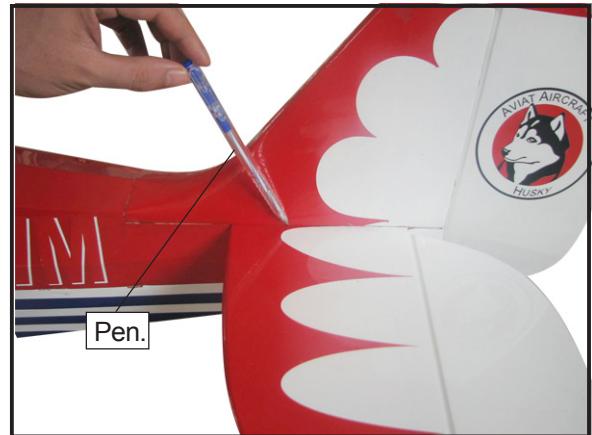

□ 5) Remove the stabilizer. Using the lines you just drew as a guide, carefully remove the covering from between them using a modeling knife.

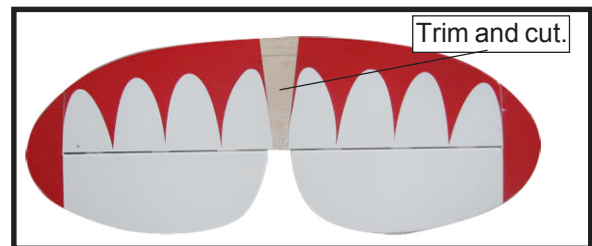

**!** When cutting through the covering to remove it, cut with only enough pressure to only cut through the covering itself. Cutting into the balsa structure may weaken it.

□ 6) Using a modeling knife, carefully remove the covering that overlaps the stabilizer mounting platform sides in the fuselage. Remove the covering from both the top and the bottom of the platform sides.

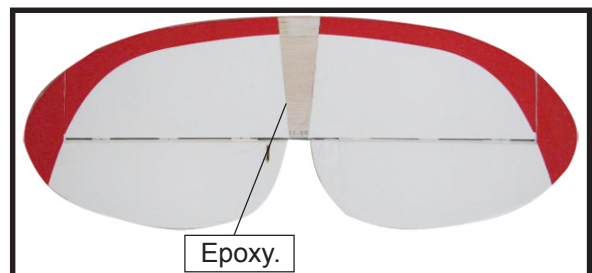

□ 7) When you are sure that everything is aligned correctly, mix up a generous amount of 30 Minute Epoxy. Apply a thin layer to the top and bottom of the stabilizer mounting area and to the stabilizer mounting platform sides in the fuselage. Slide the stabilizer in place and realign. Double check all of your measurements once more before the epoxy cures. Hold the stabilizer in place with T-pins or masking tape and remove any excess epoxy using a paper towel and rubbing alcohol.

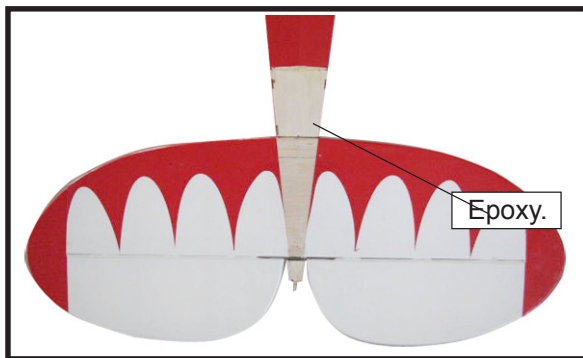
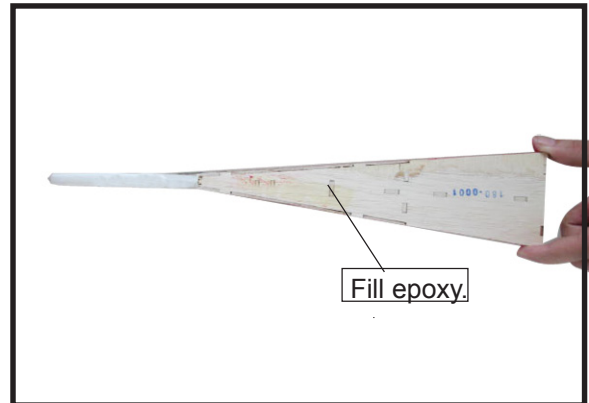
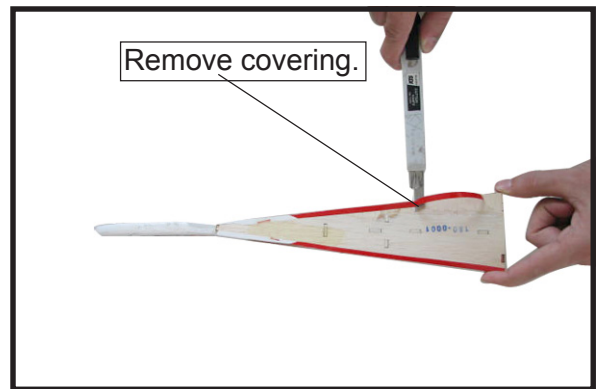
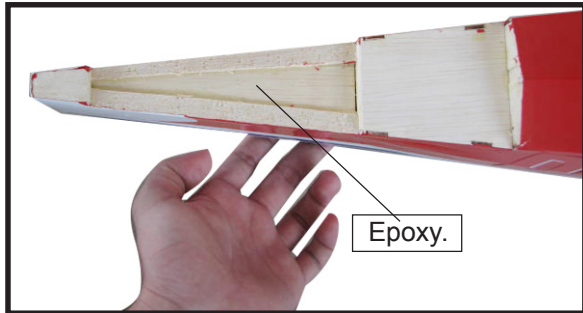

2) While holding the vertical stabilizer firmly in place, use a pen and draw a line on each side of the vertical stabilizer where it meets the top of the fuselage.

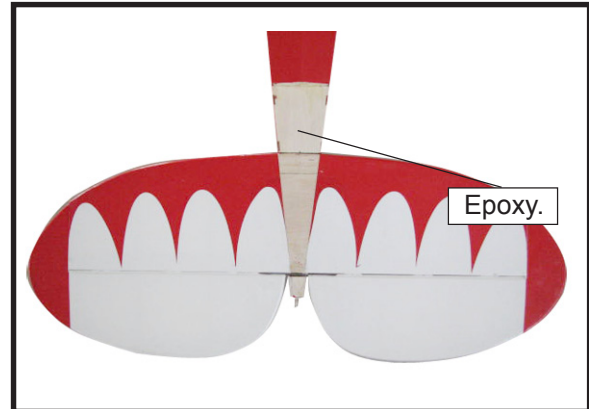

**INSTALLING VERITICAL STABILIZER.**



3) Slide the vertical stabilizer back in place. Using a triangle, check to ensure that the vertical stabilizer is aligned 90° to the horizontal stabilizer.

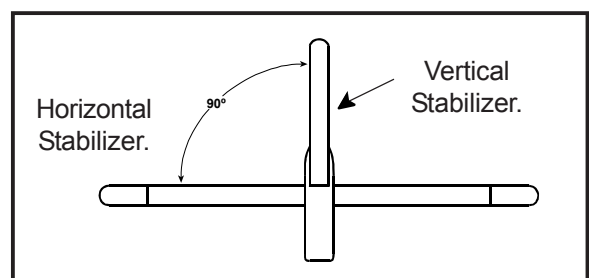

□ 1) Using a modeling knife, remove the covering from over the precut hinge slot cut into the lower rear portion of the fuselage.

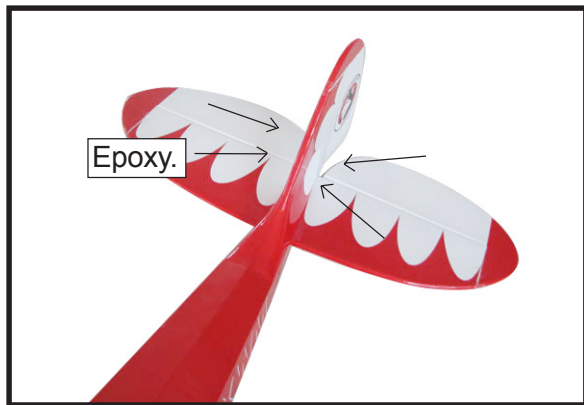
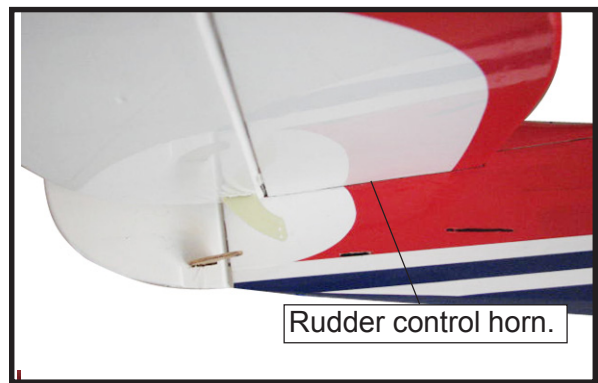
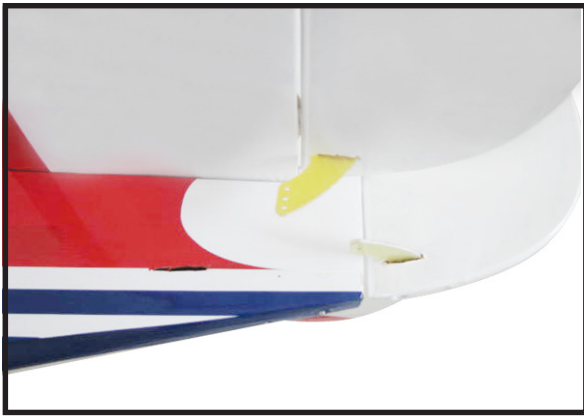

4) When you are sure that everything is aligned correctly, mix up a generous amount of Flash 30 Minute Epoxy. Apply a thin layer to the mounting slot and to bottom of the vertical stabilizer mounting area. Apply epoxy to the bottom and top edges of the filler block and to the lower hinge also. Set the stabilizer in place and realign. Double check all of your measurements once more before the epoxy cures. Hold the stabilizer in place with T-pins or masking tape and remove any excess epoxy using a paper towel and rubbing alcohol. Allow the epoxy to fully cure before proceeding.

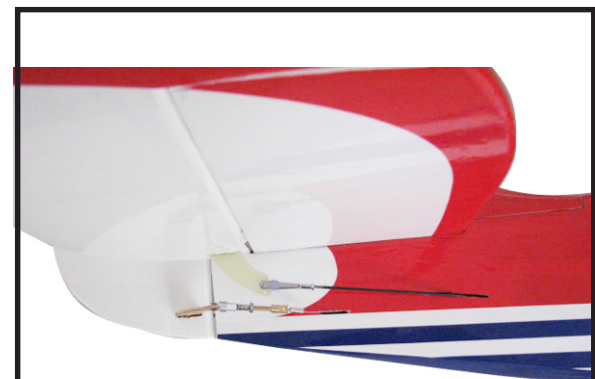
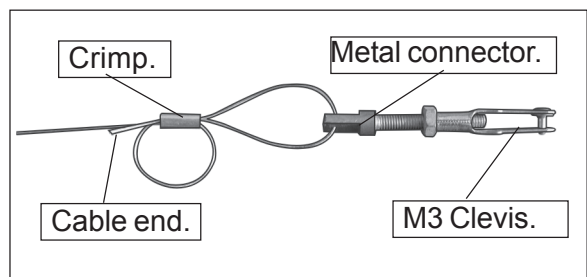
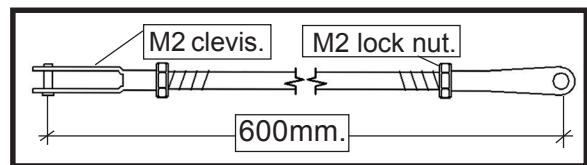

**ELEVATOR AND RUDDER PUSHROD HORN INSTALLATION.**

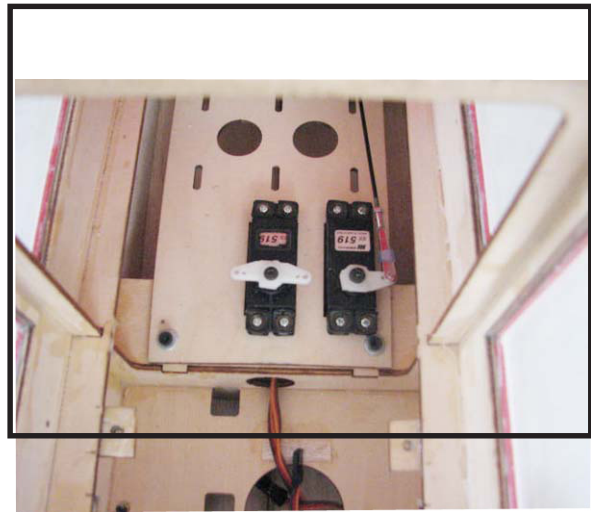

**INSTALLATION TAILWHEEL.**

1) Locate the items for this section of the manual.

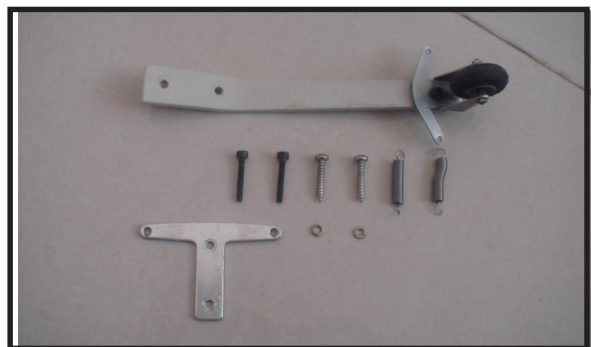

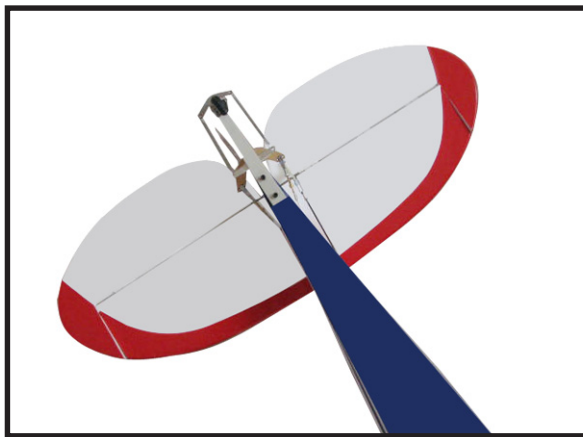
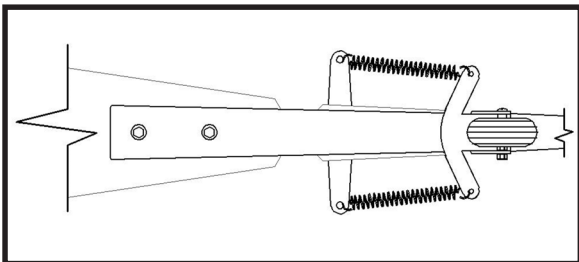
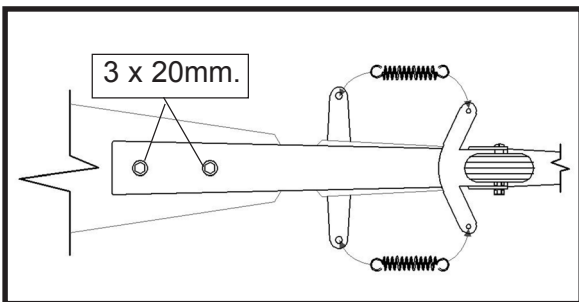
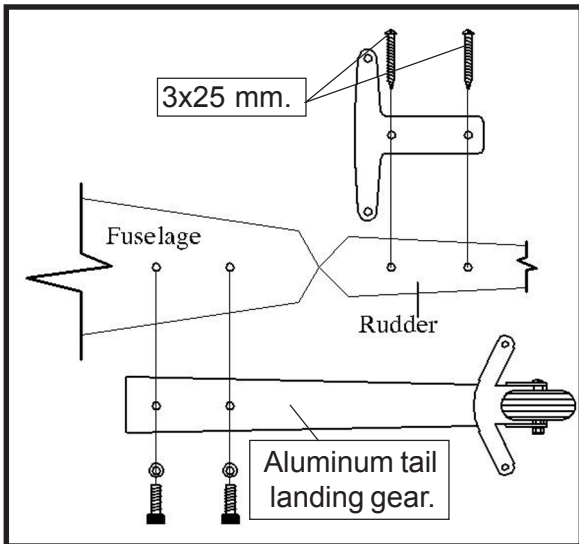

**INSTALLATION PILOT AND CANOPY.**

1) Locate items necessary to install pilot, seats



2) A scale pilot is included with this ARF. The Seagull Pilot included fitting well to the cockpit. (or you can order others scale pilot figures made by Seagull factory. They are available at Seagull distributors.)

If you are going to install a pilot figure, please use a sanding bar to sand the base of the figure so that it is flat.

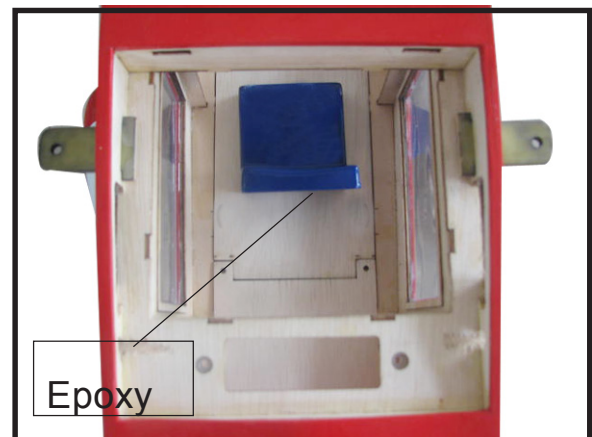
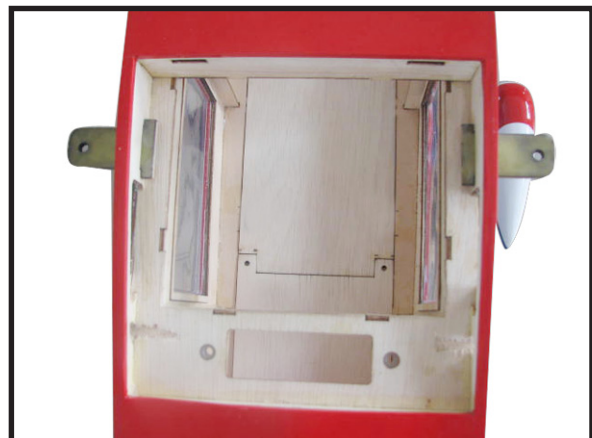





### APPLY THE DECALS.

1) If all the decals are precut and ready to stick. Please be certain the model is clean and free from oily fingerprints and dust. Position decal on the model where desired, using the photos on the box and aid in their location.

2) If all the decals are not precut, please use scissors or a sharp hobby knife to cut the decals from the sheet. Please be certain the model is clean and free from oily fingerprints and dust. Position decal on the model where desired, using the photos on the box and aid in their location.

### INSTALLING BATTERY-RECEIVER.

- 1) Plug the five servo leads and the switch lead into the receiver. Plug the battery pack lead into the switch also.
- 2) Wrap the receiver and battery pack in the protective foam rubber to protect them from vibration.
- 3) Route the antenna in the antenna tube inside the fuselage and secure it to the bottom of fuselage using a plastic tape.

 *Recomend Wrapping Receiver in Plastic Bag or Baloon if flying off water.*

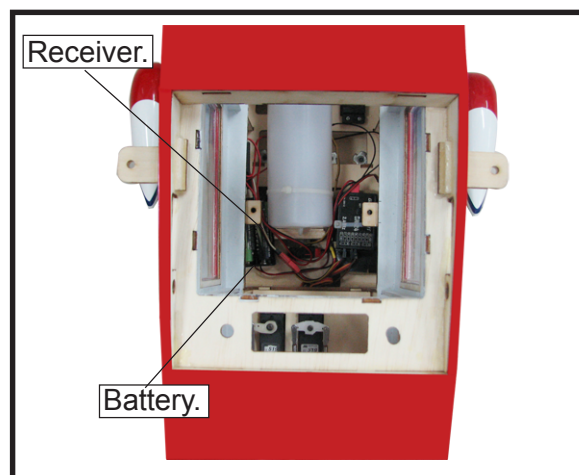

### ATTACHMENT WING- FUSELAGE.

Attach the aluminium tube into fuselage.

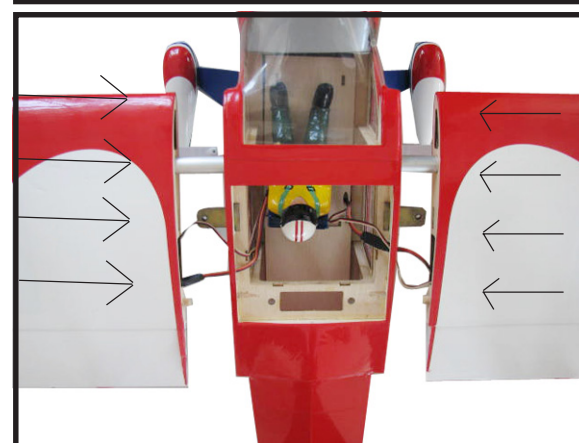
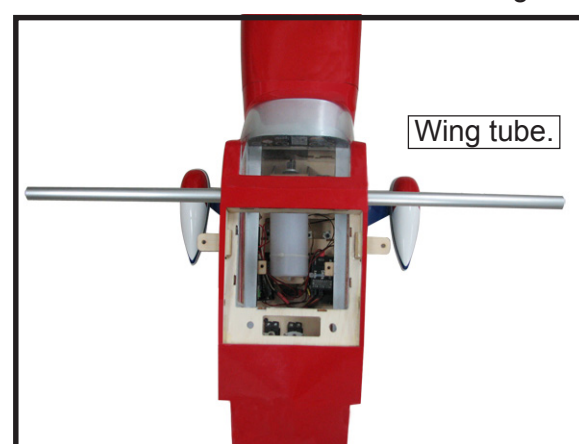

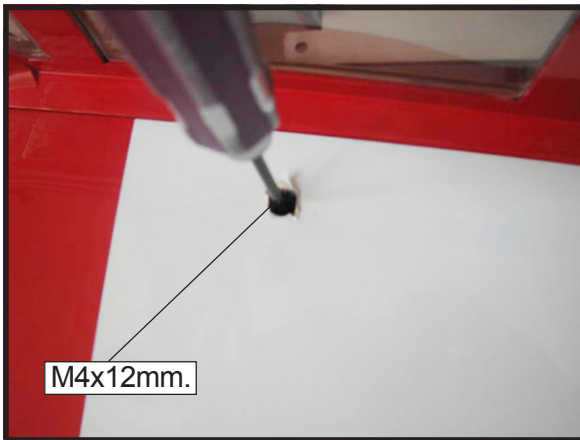
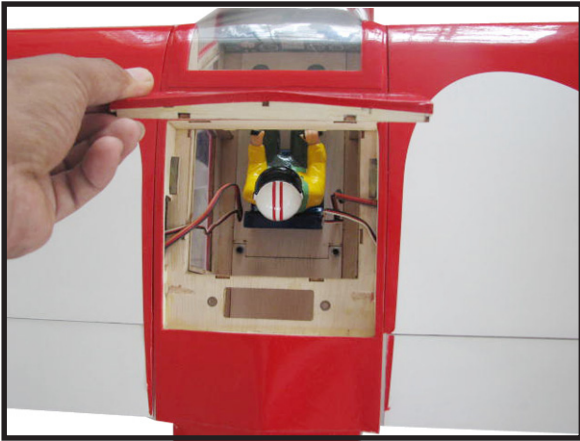

**INSTALLATION STRUT  
WING-FUSELAGE.**

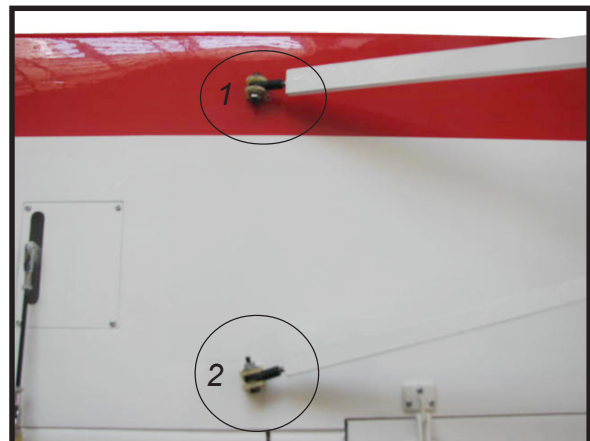
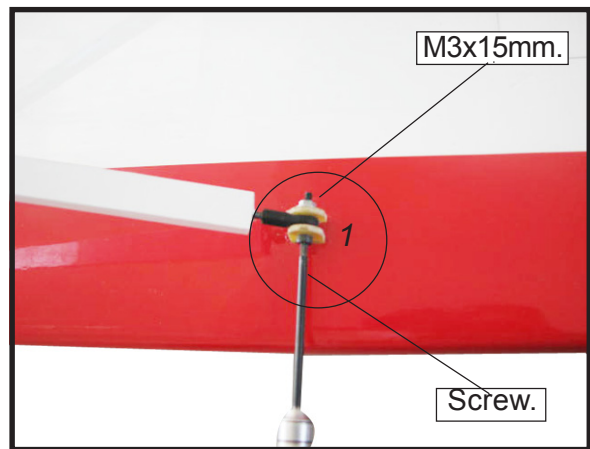
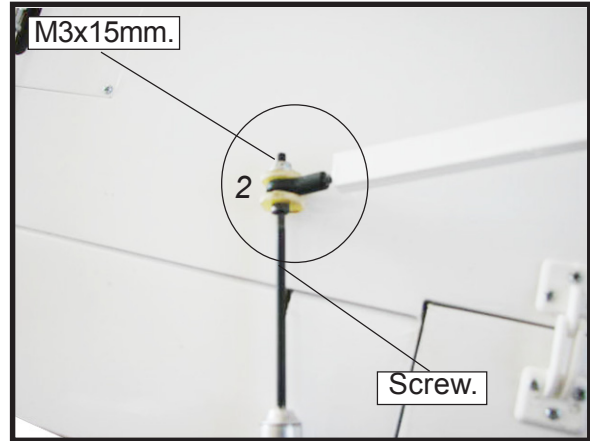
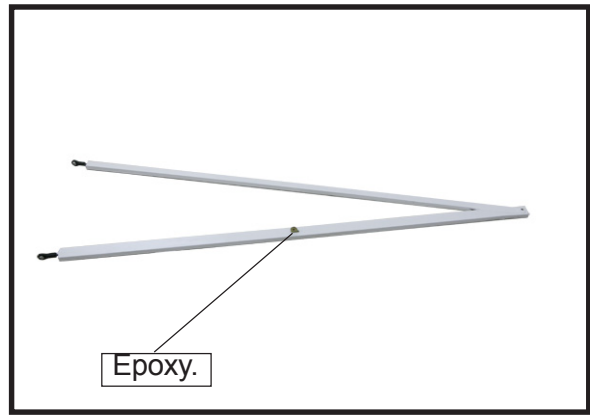
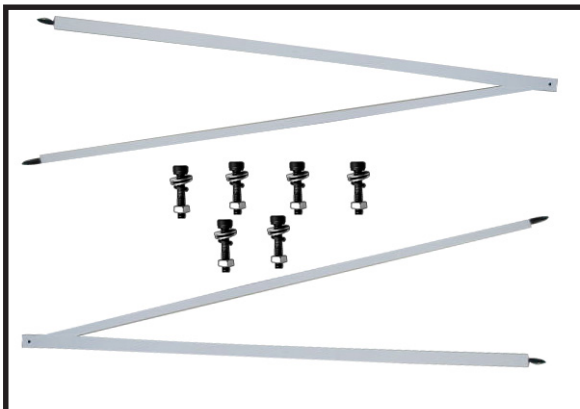

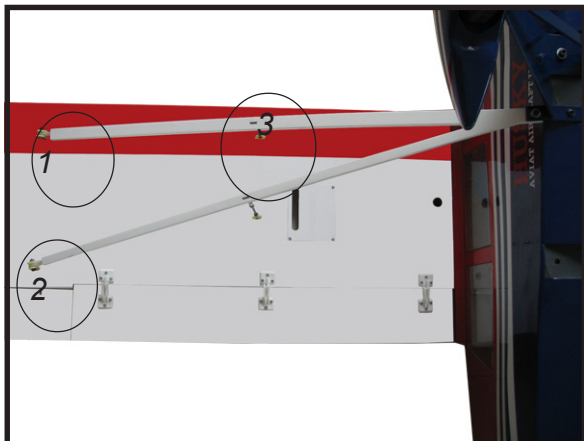
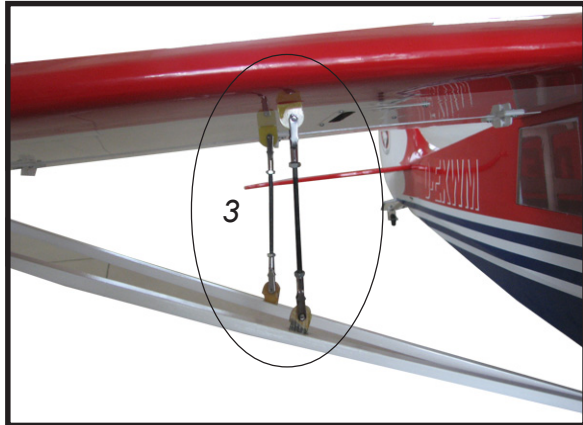
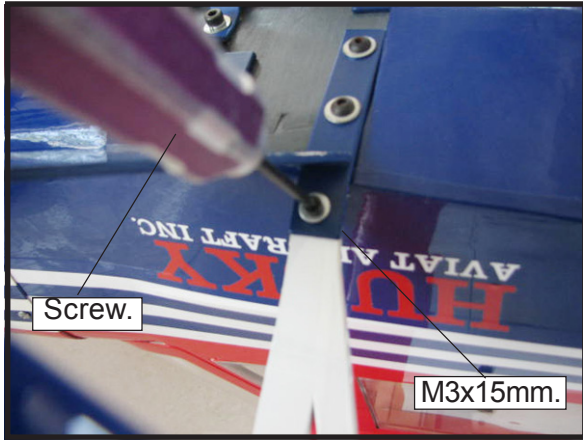

### OPTIONAL FLOAT FOR HUSKY.

Install Structs onto floats

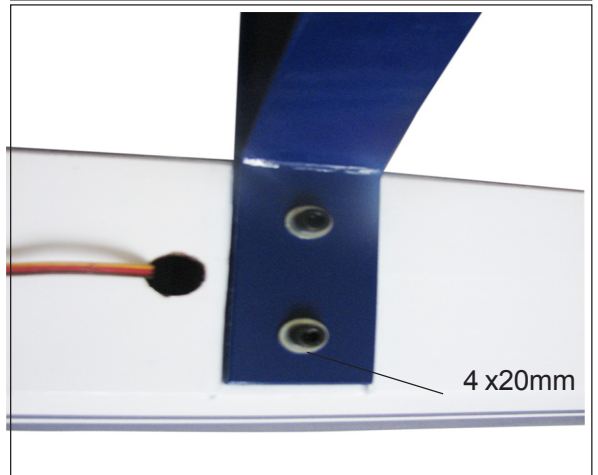
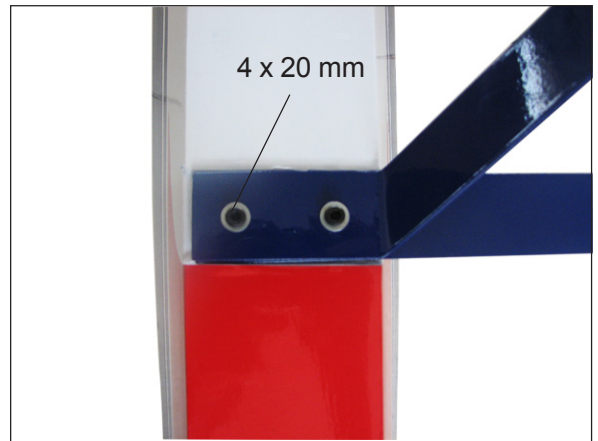
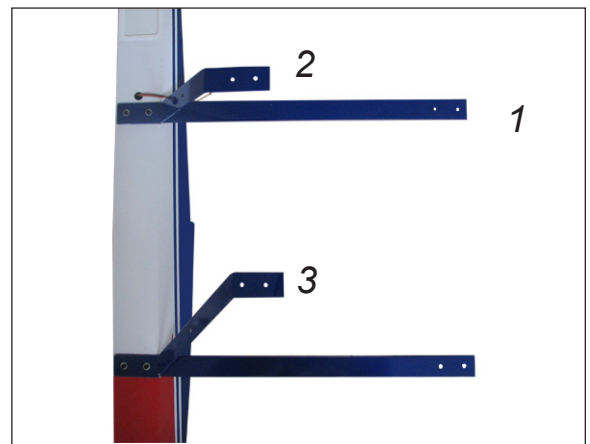
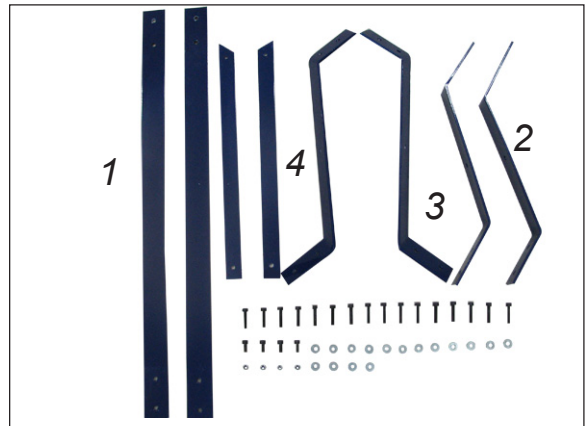

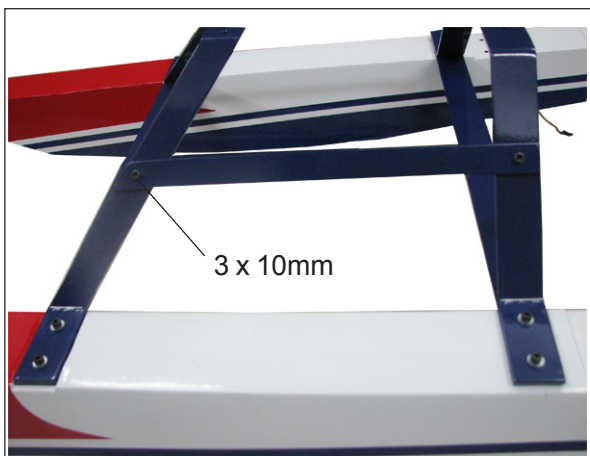
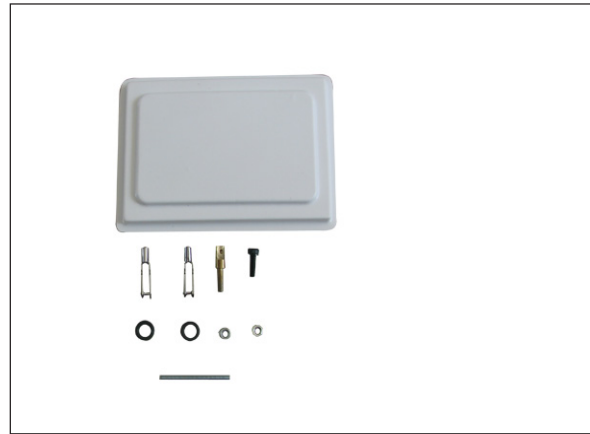
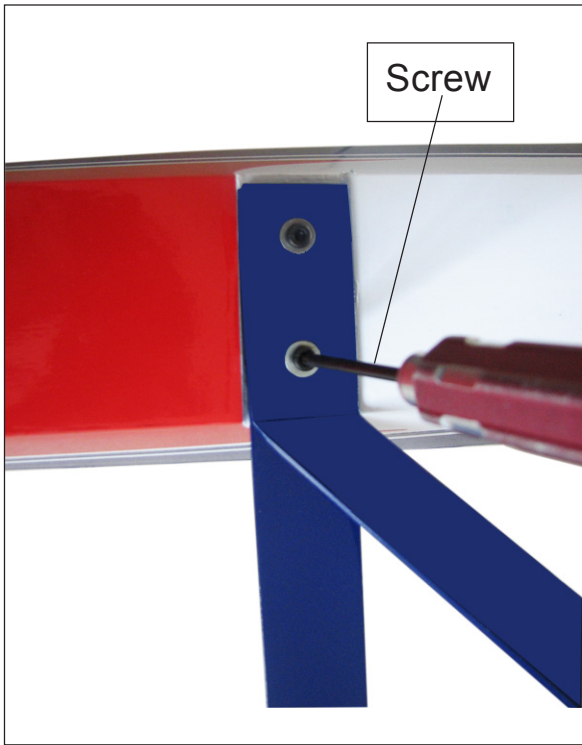

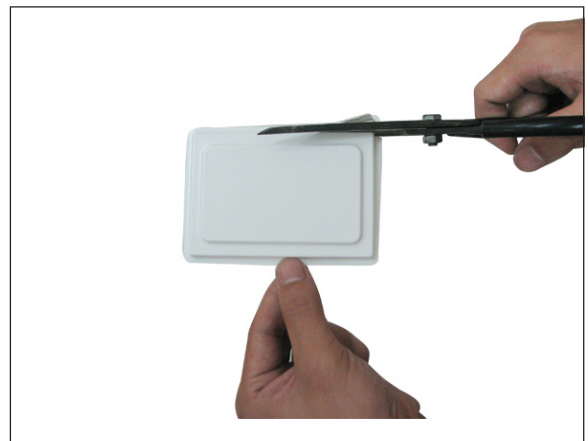
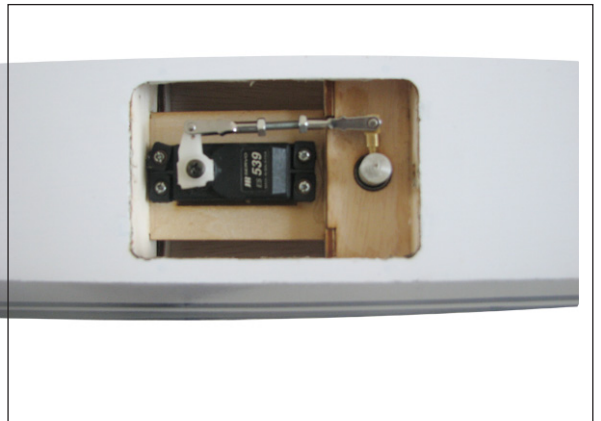
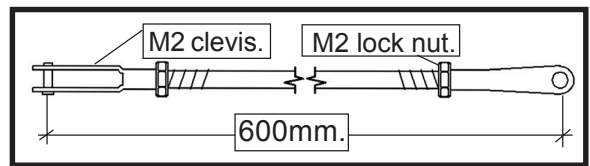
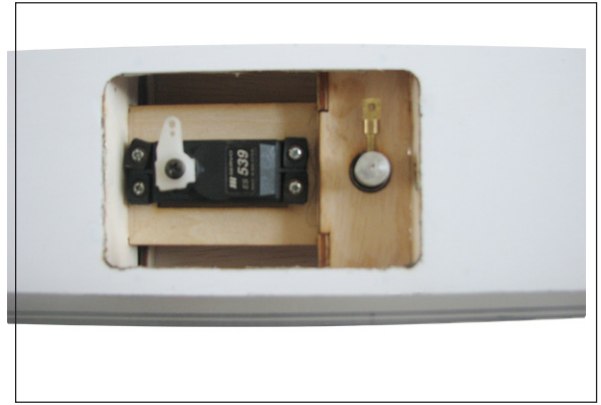
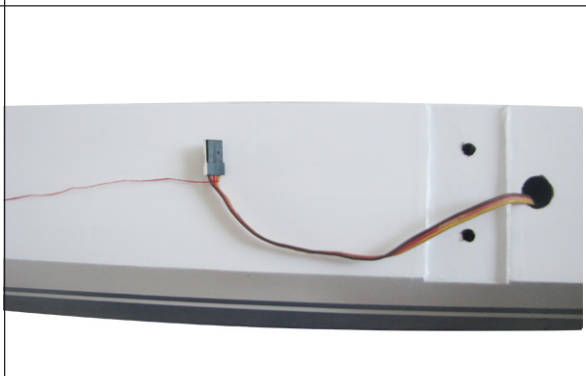
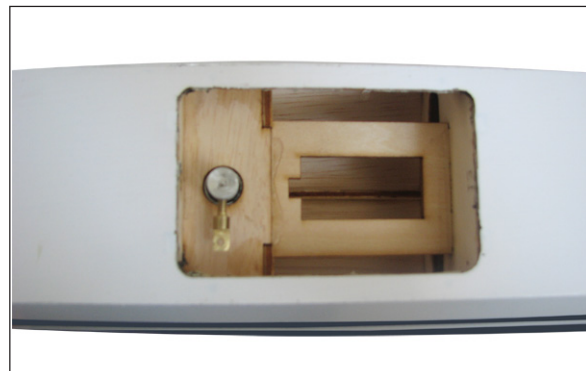

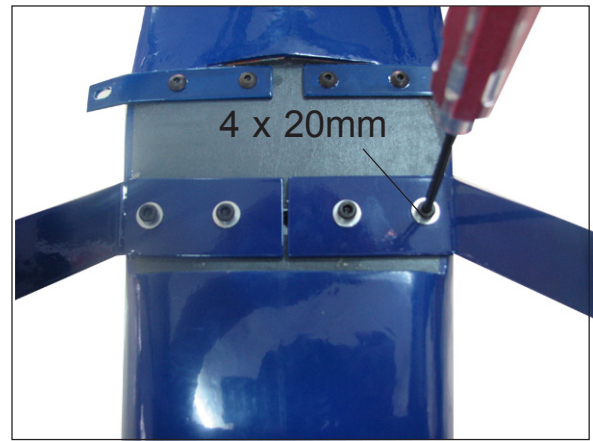
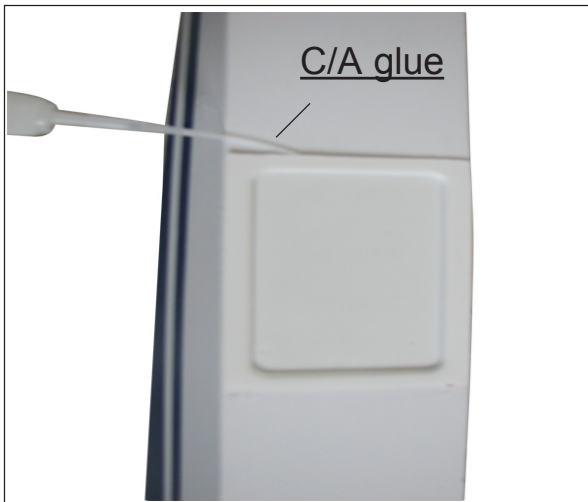

**BALANCING.**

□ 1) It is critical that your airplane be balanced correctly. Improper balance will cause your plane to lose control and crash. THE CENTER OF GRAVITY IS LOCATED **60 MM** BACK FROM THE LEADING EDGE OF THE WING AT THE WING ROOT.

□ 2) Mount the wing to the fuselage. Using a couple of pieces of masking tape, place them on the bottom side of the wing **60=mm** back from the leading edge of the wing at the wing root.

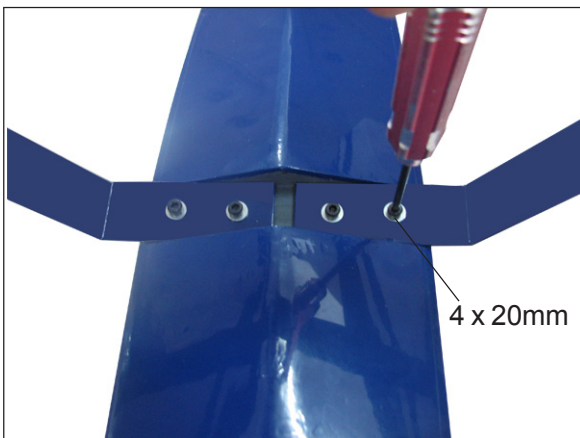

□ 3) With the model upright, place your fingers on the masking tape and carefully lift the plane.

1 4) Do not turn plane upside down. Only low wing models should be turned upsidedown for balancing. Remove this paragraph, it is not intended for use in the instructions. it is a note for you.High Wing models must be balanced upright.

Accurately mark the balance point on the botttom of the wing on both sides of the fuselage. The balance point is located **60 mm** back from the leading edge of the wing at the wing root. This is the balance point at which your model should balance for your first flights. Later, you may wish to experiment by shifting the balance up to 10mm forward or back to change the flying characteristics. Moving the balance forward may improve the smoothness and arrow- like tracking, but it may then require more speed for take off and make it more difficult to slow down for landing. Moving the balance aft makes the model more agile with a lighter and snappier "feel". In any case,please start at the location we recommend .

With the wing attached to the fuselage, all parts of the model installed ( ready to fly), and empty fuel tanks, hold the model at the marked balance point with the stabilizer level.

Lift the model. If the tail drops when you lift, the model is "tail heavy" and you must add weight\* to the nose. If the nose drops, it is "nose heavy" and you must add weight\* to the tail to balance.

\*If possible, first attempt to balance the model by changing the position of the receiver battery and receiver. If you are unable to obtain good balance by doing so, then it will be necessary to add weight to the nose or tail to achieve the proper balance point.

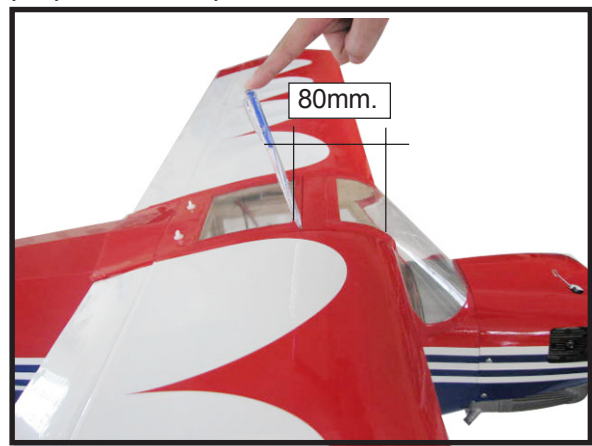

### CONTROL THROWS.

Ailerons:	12mm - 15mm up 12mm - 15mm down.
Elevator:	12mm - 15mm up. 12mm - 15mm down.
Rudder:	20mm - 30mm left. 20mm - 30mm right.

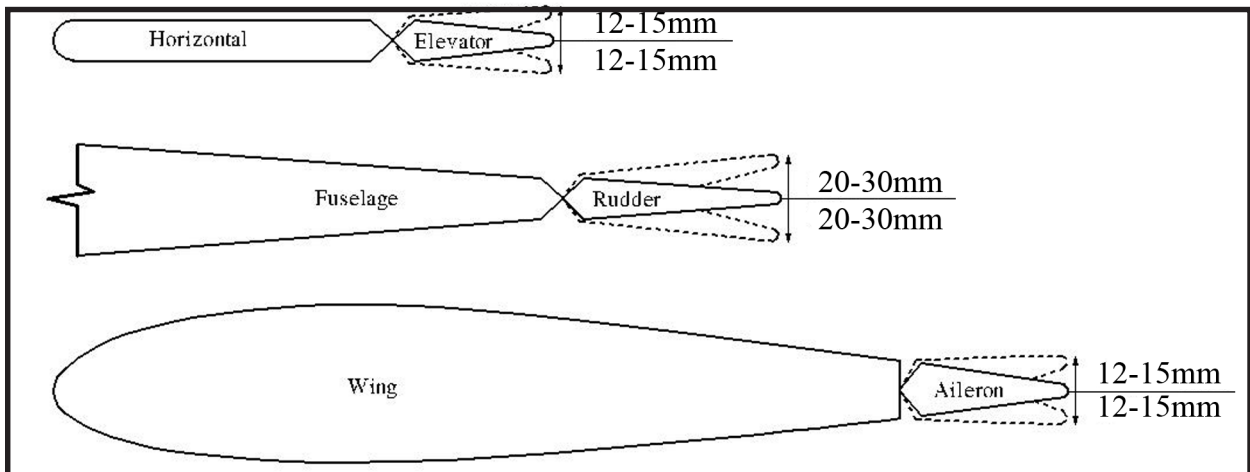

**FLIGHT PREPARATION.**

Check the operation and direction of the elevator, rudder, ailerons and throttle.

A) Plug in your radio system per the manufacturer's instructions and turn everything on.

B) Check the elevator first. Pull back on the elevator stick. The elevator halves should move up. If it they do not, flip the servo reversing switch on your transmitter to change the direction.

C) Check the rudder. Looking from behind the airplane, move the rudder stick to the right. The rudder should move to the right. If it does not, flip the servo reversing switch on your transmitter to change the direction.

D) Check the throttle. Moving the throttle stick forward should open the carburetor barrel. If it does not, flip the servo reversing switch on your transmitter to change the direction.

E) From behind the airplane, look at the aileron on the right wing half. Move the aileron stick to the right. The right aileron should move up and the other aileron should move down. If it does not, flip the servo reversing switch on your transmitter to change the direction.

**PREFLIGHT CHECK.**

1) Completely charge your transmitter and receiver batteries before your first day of flying.

2) Check every bolt and every glue joint in the **CHRISTEN HUSKY** to ensure that everything is tight and well bonded.

3) Double check the balance of the airplane. Do this with the fuel tank empty.

4) Check the control surfaces. All should move in the correct direction and not bind in any way.

5) If your radio transmitter is equipped with dual rate switches double check that they are on the low rate setting for your first few flights.

6) Check to ensure the control surfaces are moving the proper amount for both low and high rate settings.

7) Check the receiver antenna. It should be fully extended and not coiled up inside the fuselage.

8) Properly balance the propeller. An out of balance propeller will cause excessive vibration which could lead to engine and/or airframe failure.

***We wish you many safe and enjoyable flights  
with your CHRISTEN HUSKY.***