

1/10 LUXURY ELECTRIC FORMULA

XTRAY X1

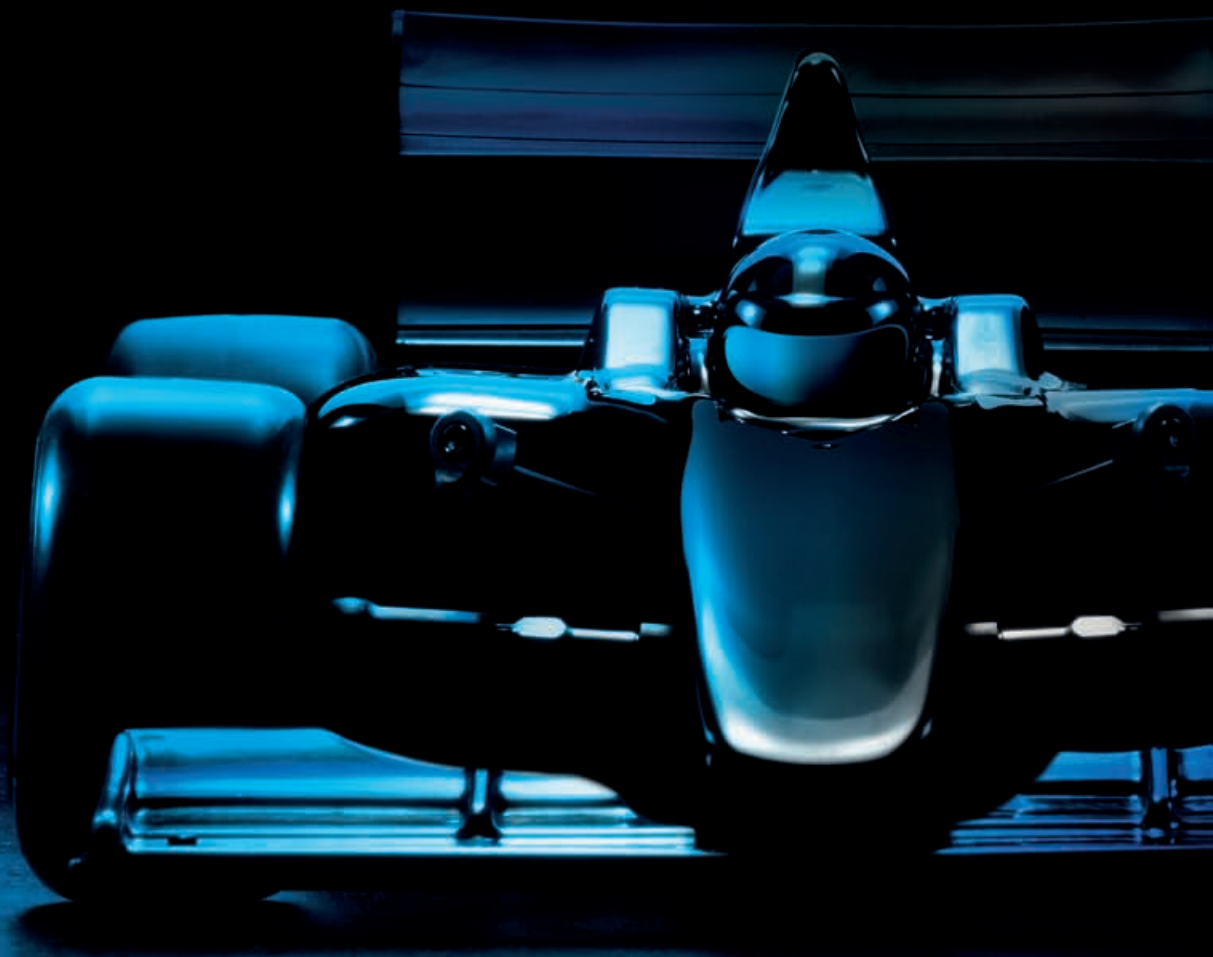

INSTRUCTION MANUAL
FOR X1'24 EDITION

BEFORE YOU START

This is a high-competition, high-quality RC car intended for persons aged 16 years and older with previous experience building and operating RC model racing cars. This is not a toy; it is a precision racing model. This model racing car is not intended for use by beginners, inexperienced customers, or by children without direct supervision of a responsible, knowledgeable adult. If you DO NOT fulfill these requirements, please return the kit in unused and unassembled form back to the shop where you have purchased it.

Before building and operating your XRAY, **YOU MUST** read through all of the operating instructions and instruction manual and fully understand them to get the maximum enjoyment and prevent unnecessary damage.

CUSTOMER SUPPORT

We have made every effort to make these instructions as easy to understand as possible. However, if you have any difficulties, problems, or questions, please DO NOT hesitate to contact the XRAY support team at info@teamxray.com. Also, please visit our Web site at www.teamxray.com to find the latest updates, set-up information, option parts, and many other goodies. We pride ourselves on taking excellent care of our customers.

You can join thousands of XRAY fans and enthusiasts in our online community at: www.teamxray.com

Read carefully and fully understand the instructions before beginning assembly.

Make sure you review this entire manual, download and use set-up book from the web, and examine all details carefully. If for some reason you decide this is not what you wanted or expected, **DO NOT continue any further**. Your hobby dealer can not accept your kit for return or exchange after it has been partially or fully assembled.

Contents of the box may differ from pictures. In line with our policy of continuous product development, the exact specifications of the kit may vary without prior notice.

XRAY Europe

K Vystavisku 6992
91101 Trenčín
Slovakia, EUROPE
Phone: 421-32-7401100
Fax: 421-32-7401109
E-mail: info@teamxray.com

XRAY USA

RC America, 2030 Century Center Blvd #15
Irving, TX 75062
USA
Phone: (214) 744-2400
Fax: (214) 744-2401
E-mail: xray@rcamerica.com

FAILURE TO FOLLOW THESE INSTRUCTIONS WILL BE CONSIDERED AS ABUSE AND/OR NEGLIGENCE.

SAFETY PRECAUTIONS

Contains:

LEAD (CAS 7439-92-1) ANTIMONY (CAS 7440-36-0)

WARNING: This product contains a chemical known to the state of California to cause cancer and birth defects or other reproductive harm.

CAUTION: CANCER HAZARD

Contains lead, a listed carcinogen. Lead is harmful if ingested. Wash thoroughly after using. DO NOT use product while eating, drinking or using tobacco products. May cause chronic effects to gastrointestinal tract, CNS, kidneys, and blood. **MAY CAUSE BIRTH DEFECTS.**

When building, using and/or operating this model always wear protective glasses and gloves.

Take appropriate safety precautions prior to operating this model. You are responsible for this model's assembly and safe operation! Please read the instruction manual before building and operating this model and follow all safety precautions. Always keep the instruction manual at hand for quick

reference, even after completing the assembly. Use only genuine and original authentic XRAY parts for maximum performance. Using any third party parts on this model will void guaranty immediately.

Improper operation may cause personal and/or property damage. XRAY and its distributors have no control over damage resulting from shipping, improper construction, or improper usage. XRAY assumes and accepts no responsibility for personal and/or property damages resulting from the use of improper building materials, equipment and operations. By purchasing any item produced by XRAY, the buyer expressly warrants that he/she is in compliance with all applicable federal, state and local laws and regulation regarding the purchase, ownership and use of the item. The buyer expressly agrees to indemnify and hold harmless XRAY for all claims resulting directly or indirectly from the purchase, ownership or use of the product. By the act of assembling or operating this product, the user accepts all resulting liability. If the buyer is not prepared to accept this liability, then he/she should return this kit in new, unassembled, and unused condition to the place of purchase.



IMPORTANT NOTES - GENERAL

- This product is not suitable for children under 16 years of age without the direct supervision of a responsible and knowledgeable adult.
- Carefully read all manufacturers warnings and cautions for any parts used in the construction and use of your model.
- Assemble this kit only in places away from the reach of very small children.
- First-time builders and users should seek advice from people who have building experience in order to assemble the model correctly and to allow the model to reach its performance potential.
- Exercise care when using tools and sharp instruments.
- Take care when building, as some parts may have sharp edges.
- Keep small parts out of reach of small children. Children must not be allowed to put any parts in their mouth, or pull vinyl bag over their head.
- Read and follow instructions supplied with paints and/or cement, if used (not included in kit).
- Immediately after using your model, DO NOT touch equipment on the model such as the motor and speed controller, because they generate high temperatures. You may seriously burn yourself seriously touching them.
- Follow the operating instructions for the radio equipment at all times.
- DO NOT put fingers or any objects inside rotating and moving parts, as this may cause damage or serious injury as your finger, hair, clothes, etc. may get caught.
- Be sure that your operating frequency is clear before turning on or running your model, and never share the same frequency with somebody else at the same time. Ensure that others are aware of the operating frequency you are using and when you are using it.
- Use a transmitter designed for ground use with RC cars. Make sure that no one else is using the same frequency as yours in your operating area. Using the same frequency at the same time, whether it is driving, flying or sailing, can cause loss of control of the RC model, resulting in a serious accident.
- Always turn on your transmitter before you turn on the receiver in the car. Always turn off the receiver before turning your transmitter off.
- Keep the wheels of the model off the ground when checking the operation of the radio equipment.
- Disconnect the battery pack before storing your model.
- When learning to operate your model, go to an area that has no obstacles that can damage your model if your model suffers a collision.
- Remove any sand, mud, dirt, grass or water before putting your model away.
- If the model behaves strangely, immediately stop the model, check and clear the problem.
- To prevent any serious personal injury and/or damage to property, be responsible when operating all remote controlled models.
- The model car is not intended for use on public places and roads or areas where its operation can conflict with or disrupt pedestrian or vehicular traffic.
- Because the model car is controlled by radio, it is subject to radio interference from many sources that are beyond your control. Since radio interference can cause momentary loss of control, always allow a safety margin in all directions around the model in order to prevent collisions.
- DO NOT use your model:
 - Near real cars, animals, or people that are unaware that an RC car is being driven.
 - In places where children and people gather
 - In residential districts and parks
 - In limited indoor spaces
 - In wet conditions
 - In the street
 - In areas where loud noises can disturb others, such as hospitals and residential areas.
 - At night or anytime your line of sight to the model may be obstructed or impaired in any way.

To prevent any serious personal injury and/or damage to property, please be responsible when operating all remote controlled models.

IMPORTANT NOTES - ELECTRICAL

- Insulate any exposed electrical wiring (using heat shrink tubing or electrical tape) to prevent dangerous short circuits. Take maximum care in wiring, connecting and insulating cables. Make sure cables are always connected securely. Check connectors for if they become loose. And if so, reconnect them securely. Never use RC models with damaged wires. A damaged wire is extremely dangerous, and can cause short-circuits resulting in fire. Please have wires repaired at your local hobby shop.
- Low battery power will result in loss of control. Loss of control can occur due to a weak battery in either the transmitter or the receiver. Weak running battery may also result in an out of control car if your car's receiver power is supplied by the running battery. Stop operation immediately if the car starts to slow down.
- When not using RC model, always disconnect and remove battery.
- DO NOT disassemble battery or cut battery cables. If the running battery short-circuits, approximately 300W of electricity can be discharged, leading to fire or burns. Never disassemble battery or cut battery cables.
- Use a recommended charger for the receiver and transmitter batteries and follow the instructions correctly. Over-charging, incorrect charging,

or using inferior chargers can cause the batteries to become dangerously hot. Recharge battery when necessary. Continual recharging may damage battery and, in the worst case, could build up heat leading to fire. If battery becomes extremely hot during recharging, please ask your local hobby shop for check and/or repair and/or replacement.

- Regularly check the charger for potential hazards such as damage to the cable, plug, casing or other defects. Ensure that any damage is rectified before using the charger again. Modifying the charger may cause short-circuit or overcharging leading to a serious accident. Therefore DO NOT modify the charger.
- Always unplug charger when recharging is finished.
- DO NOT recharge battery while battery is still warm. After use, battery retains heat. Wait until it cools down before charging.
- DO NOT allow any metal part to short circuit the receiver batteries or other electrical/electronic device on the model.
- Immediately stop running if your RC model gets wet as may cause short circuit.
- Please dispose of batteries responsibly. Never put batteries into fire.

R/C & BUILDING TIPS

- Make sure all fasteners are properly tightened. Check them periodically.
- Make sure that chassis screws DO NOT protrude from the chassis.
- For the best performance, it is very important that great care is taken to ensure the free movement of all parts.
- Clean all ball-bearings so they move very easily and freely.
- Tap or pre-thread the plastic parts when threading screws.
- Self-tapping screws cut threads into the parts when being tightened. DO NOT use excessive force when tightening the self-tapping screws because you may strip out the thread in the plastic. We recommended you stop tightening a screw when you feel some resistance.
- Ask your local hobby shop for any advice.

Please support your local hobby shop. We at XRAY Model Racing Cars support all local hobby dealers. Therefore we ask you, if at all possible, to purchase XRAY products at your hobby dealer and give them your support like we do. If you have difficulty finding XRAY products, please check out www.teamxray.com to get advice, or contact us via email at info@teamxray.com, or contact the XRAY distributor in your country.

WARRANTY

XRAY guarantees this model kit to be free from defects in both material and workmanship within 30 days of purchase. The total monetary value under warranty will in no case exceed the cost of the original kit purchased. This warranty does not cover any components damaged by use or modification or as a result of wear. Part or parts missing from this kit must be reported within 30 days of purchase. No part or parts will be sent under warranty without proof of purchase. Should you find a defective or missing part, contact the local distributor. Service and customer support will be provided through local hobby store where you have purchased the kit, therefore make sure to purchase any XRAY products at your local hobby store. This model racing car is considered to be a high-performance racing vehicle. As such this vehicle will be used in an extreme range of conditions and situations, all which may cause premature wear or failure of any component. XRAY has no control over usage of vehicles once they leave the dealer, therefore XRAY can only offer warranty against all manufacturer's defects in materials, workmanship, and assembly at point of sale and before use. No warranties are expressed or implied that cover damage caused by what is considered normal use, or cover or imply how long any model cars' components or electronic components will last before requiring replacement.

Due to the high performance level of this model car you will need to periodically maintain and replace consumable components. Any and all warranty coverage will not cover replacement of any part or component damaged by neglect, abuse, or improper or unreasonable use. This includes

but is not limited to damage from crashing, chemical and/or water damage, excessive moisture, improper or no maintenance, or user modifications which compromise the integrity of components. Warranty will not cover components that are considered consumable on RC vehicles. XRAY does not pay nor refund shipping on any component sent to XRAY or its distributors for warranty. XRAY reserves the right to make the final determination of the warranty status of any component or part.

Limitations of Liability

XRAY makes no other warranties expressed or implied. XRAY shall not be liable for any loss, injury or damages, whether direct, indirect, special, incidental, or consequential, arising from the use, misuse, or abuse of this product and/or any product or accessory required to operate this product. In no case shall XRAY's liability exceed the monetary value of this product.

Take adequate safety precautions prior to operating this model. You are responsible for this model's assembly and safe operation.

Disregard of the any of the above cautions may lead to accidents, personal injury, or property damage. XRAY MODEL RACING CARS assumes no responsibility for any injury, damage, or misuse of this product during assembly or operation, nor any addictions that may arise from the use of this product.

All rights reserved.

QUALITY CERTIFICATE

XRAY MODEL RACING CARS uses only the highest quality materials, the best compounds for molded parts and the most sophisticated manufacturing processes of TQM (Total Quality Management). We guarantee that all parts of a newly-purchased kit are manufactured with the highest regard to quality. However, due to the many factors inherent in model racecar competition, we

cannot guarantee any parts once you start racing the car. Products which have been worn out, abused, neglected or improperly operated will not be covered under warranty.

We wish you enjoyment of this high-quality and high-performance RC car and wish you best success on the track!

In line with our policy of continuous product development, the exact specifications of the kit may vary. In the unlikely event of any problems with your new kit, you should contact the model shop where you purchased it, quoting the part number.

We do reserve all rights to change any specification without prior notice. All rights reserved.

X1'24

TOOLS REQUIRED



Combination Pliers
(HUDY #189020)



Side Cutters
(HUDY #189010)



Pocket Hobby Knife (HUDY #188981)



Special Tool for Turnbuckles, Nuts (HUDY #181090)



Turnbuckle Wrench 4mm (HUDY #181040)

Allen 1.5mm (#111545 - HUDY EXCLUSIVE Limited Edition)



Allen 2.0mm (#112045 - HUDY EXCLUSIVE Limited Edition)



Allen 2.5mm (#112545 - HUDY EXCLUSIVE Limited Edition)



Allen 3.0mm (#113045 - HUDY EXCLUSIVE Limited Edition)



Socket 5.5mm (#175535 - HUDY EXCLUSIVE Limited Edition)



Socket 7.0mm (#177035 - HUDY EXCLUSIVE Limited Edition)



Reamer (#107602 - HUDY EXCLUSIVE Limited Edition)

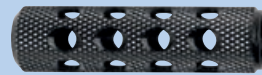

Scissors (HUDY #188990)



Professional Multi-Tool (HUDY #183011)



HUDY Blade Hobby Knife with Alu Handle (HUDY #188980)

INCLUDED

* Kit includes smaller but sufficient amount of oil and grease to build the car.

HUDY Premium Silicone Oils



600cSt
(#106360)



3.000cSt
(#106430)



30.000cSt
(#106530)



ALSO REQUIRED

Transmitter



Receiver



Speed Controller



Steering Servo



Electric Motor

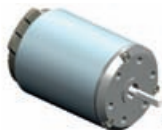

Pinion Gear with Setscrew
(#305968 - #294160)



LiPo Battery



Battery Charger



Bearing Oil
(HUDY #106230)



Wheels & Tires & Inserts
(HUDY #803072 & #803082)



Lexan™ Paint



Double-sided Tape
(HUDY #107875)



TIP



TIP

Jan Ratheisky
(Factory Driver)

The European Champion and XRAY factory team driver Jan Ratheisky shares his pro tips and tricks.

OPTIONAL



SAMPLE OF OPTIONAL PARTS

#37XXXX	TYPE1	OPTION 1
#37XXXX	TYPE1	OPTION 2
#37XXXX	TYPE1	INCLUDED
#37XXXX	TYPE1	OPTION 3

XRAY offers wide range of OPTIONAL tuning parts which are listed in a table like this. Please refer to the exploded view of each main section to verify which part is included in the kit while all other parts are available only as an optional part and must be purchased separately.

COLOR INDICATIONS

At the beginning of each section is an exploded view of the parts to be assembled. There is also a list of all the parts and part numbers that are related to the assembly of that section.

The part descriptions are color-coded to make it easier for you to identify the source of a part. Here are what the different colors mean:

372213

STYLE A - indicates parts that are included in the bag marked for the section.

371201

STYLE B - indicates parts that are included in the box.

374901

STYLE C - indicates parts that are already assembled from previous steps.

379701

STYLE D - indicates parts that are optional.

GRAPHITE PARTS PROTECTION

To protect and seal edges of graphite parts, sand edges smooth and then apply CA glue.

Make it: this for chassis edges and countersunk holes.

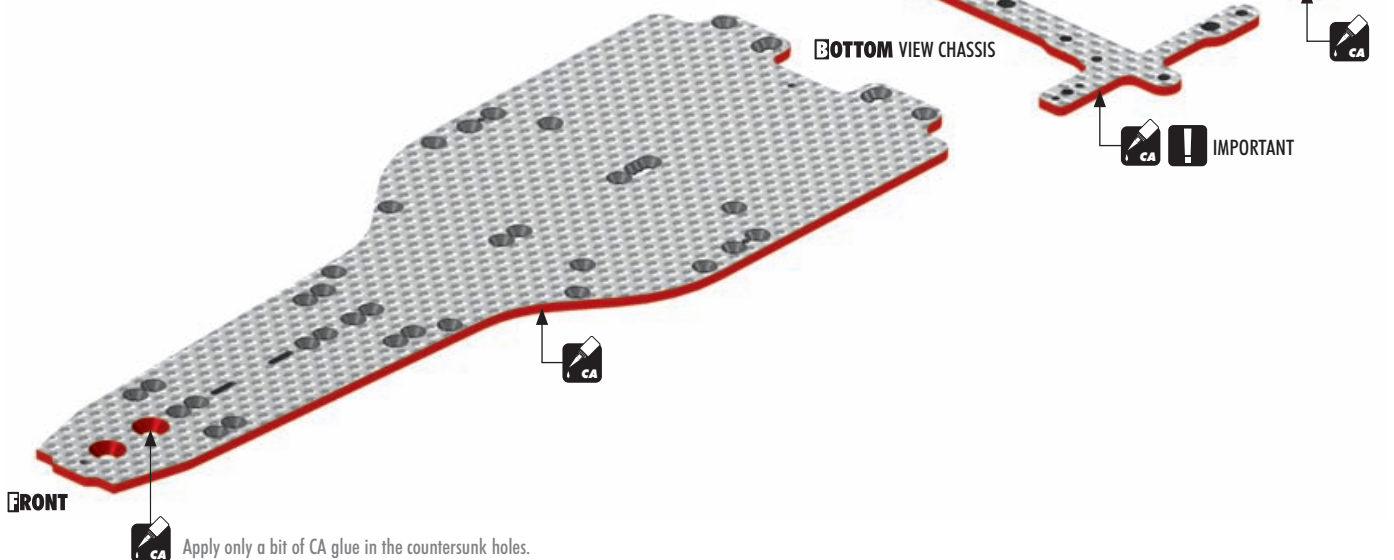
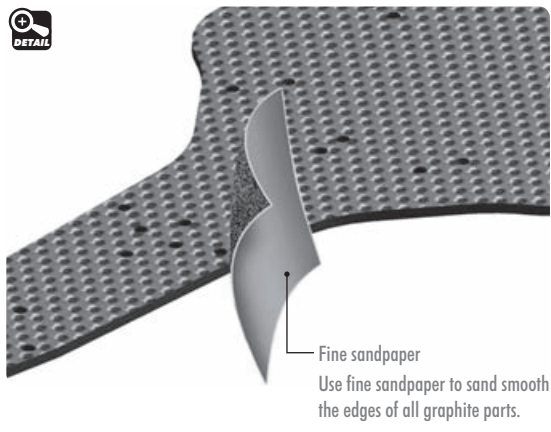

1. FRONT SUSPENSION

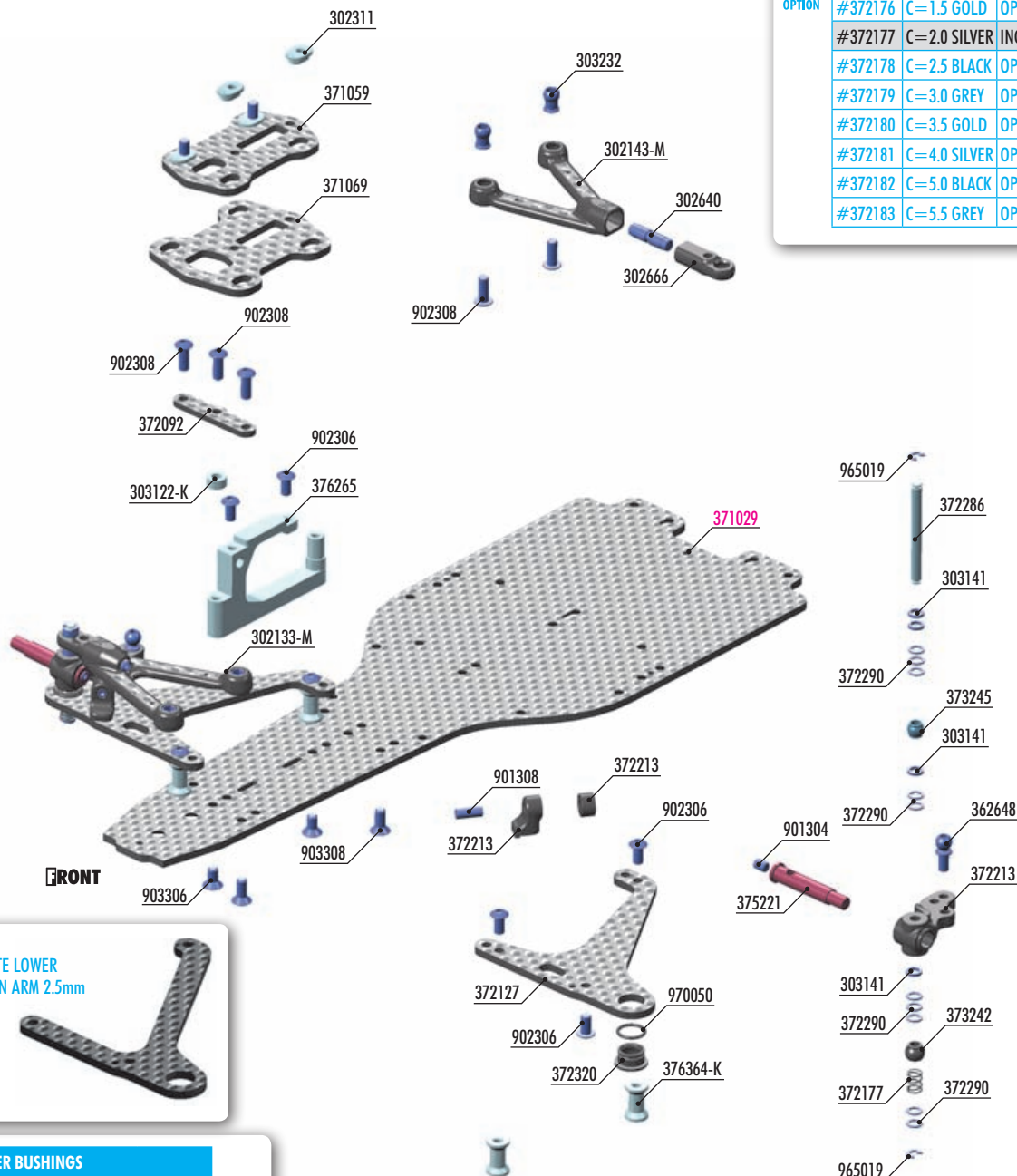

FRONT COIL SPRINGS		
#372176	C=1.5 GOLD	OPTION
#372177	C=2.0 SILVER	INCLUDED
#372178	C=2.5 BLACK	OPTION
#372179	C=3.0 GREY	OPTION
#372180	C=3.5 GOLD	OPTION
#372181	C=4.0 SILVER	OPTION
#372182	C=5.0 BLACK	OPTION
#372183	C=5.5 GREY	OPTION



#372115
X1 GRAPHITE LOWER
SUSPENSION ARM 2.5mm



ALU CASTER BUSHINGS

#302310	3.0° / 10.5°	1 Dot	OPTION
#302311	4.5° / 9.0°	2 Dots	INCLUDED
#302312	6.0° / 7.5°	3 Dots	OPTION

BAG

01

302133-M	CFE™ CARBON-FIBER FUSION UPPER ARM - MEDIUM - FR/RL	373242	COMPOSITE PIVOTBALL UNIVERSAL 6.0mm - SHORT (2)
302143-M	CFE™ CARBON-FIBER FUSION UPPER ARM - MEDIUM - FL/RR	373245	X1 UPPER ARM BALL UNIVERSAL 4.9mm - HUDY SPRING STEEL™ (2)
302311	ALU CASTER BUSHING FRONT 4° / REAR 1.5°/4.5° - 2 DOTS (4)	375221	FRONT WHEEL AXLE - HUDY SPRING STEEL™ (2)
302640	ADJUSTABLE CAMBER SCREW 14mm M4 L/R - HUDY SPRING STEEL™ (2)	376265	ALU FRONT TOP DECK MOUNT - SWISS 7075 T6
302666	COMPOSITE BALL JOINT 4.9mm F+R - OPEN (2+2)	376364-K	ALU MOUNT 10.8mm - BLACK (2)
303122-K	ALU SHIM 3x6x1.0mm (10)	901304	HEX SCREW SB M3x4 (10)
303141	ALU SHIM 3x5x1.0mm (10)	901308	HEX SCREW SB M3x8 (10)
303232	UPPER ARM BALL UNIVERSAL 4.9mm - HUDY SPRING STEEL™ (2)	902306	HEX SCREW SH M3x6 (10)
362648	BALL END 4.9mm WITH THREAD 4mm (2)	902308	HEX SCREW SH M3x8 (10)
371059	GRAPHITE ARM MOUNT PLATE - NARROW TRACK-WIDTH - 2.5mm	903306	HEX SCREW SFH M3x6 (10)
371069	GRAPHITE ARM MOUNT PLATE - WIDE TRACK-WIDTH - 2.5mm	903308	HEX SCREW SFH M3x8 (10)
372092	GRAPHITE FRONT ARM BRACE 2.2mm	965019	E-CLIP 1.9 (10)
372127	GRAPHITE LOWER SUSPENSION ARM 2.5mm	970050	O-RING 5x1 (10)
372177	FRONT COIL SPRING 3.6x6x0.5mm; C=3.5 - GOLD (2)	371029	X1/24 GRAPHITE CHASSIS 2.5mm
372213	COMPOSITE STEERING BLOCK & BACKSTOPS		
372286	KING PIN (2)		
372290	ALU SHIM 3.2x4.8x0.5 (4)		
372320	COMPOSITE ARM BUSHING (4)		

Numbers in parentheses () refer to quantities when purchased separately.

XRAY

1. FRONT SUSPENSION

10

2x 970050
0.5x1

2x LOWER ARMS



NOTE ORIENTATION

2x

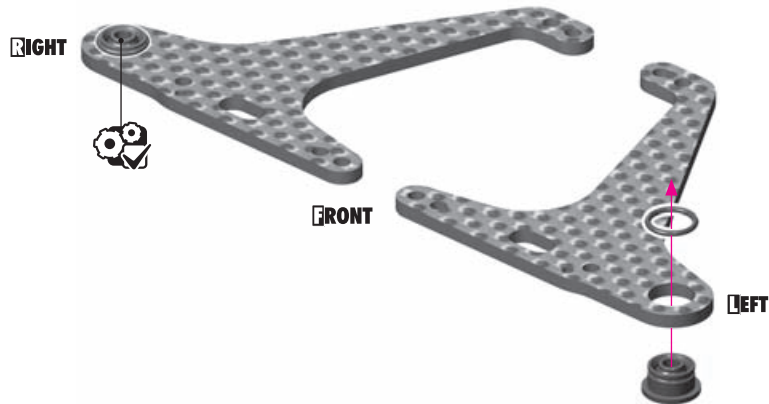

#372115
OPTION X1 GRAPHITE LOWER
SUSPENSION ARM 2.5mm

To improve steering in low-traction conditions with standard F1 front tires.



2x 901308
SB M3x8

2x

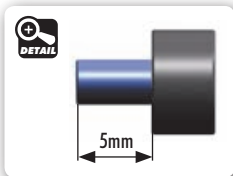
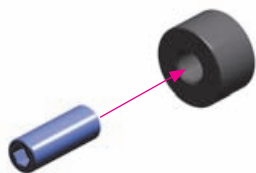

2x

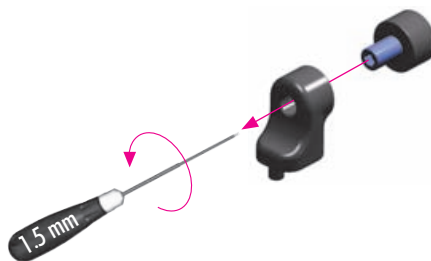

2x 902306
SH M3x6

2x LOWER ARMS

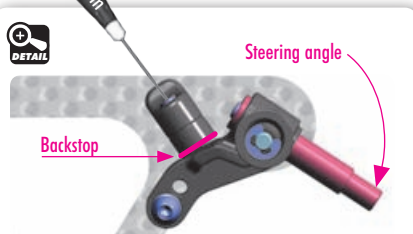
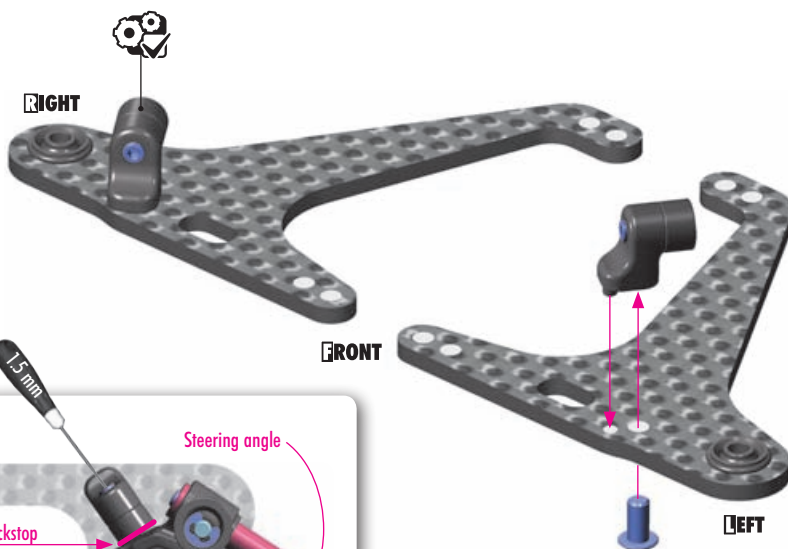

The adjustable backstops are used to limit the steering angle. Adjust the backstop with the set-screw to achieve the maximum steering angle needed. Adjust the steering angle on both L & R sides to the same amount.

TIP



Jan Ratheisky
(Factory Driver)

I recommend using 27° of steering angle for most conditions. If you use more, the car stops too much; only on very small & technical tracks does it make sense to use more.

PRO TIP to check the angle: Take a look from the top of the car on full steering. The tire angle should be parallel to the lower wishbone.

1. FRONT SUSPENSION

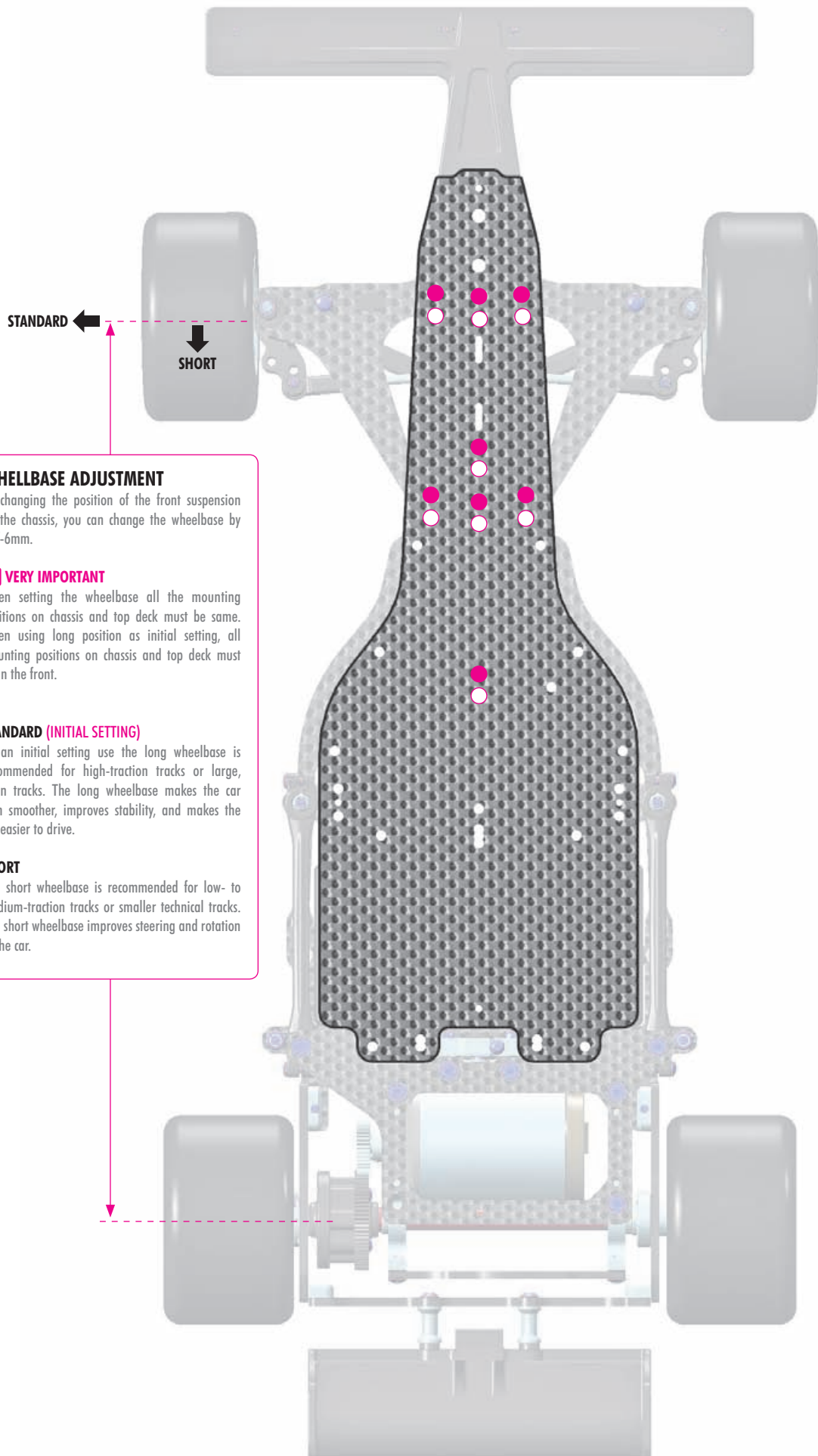

WHEELBASE ADJUSTMENT

By changing the position of the front suspension on the chassis, you can change the wheelbase by +/-6mm.

VERY IMPORTANT

When setting the wheelbase all the mounting positions on chassis and top deck must be same. When using long position as initial setting, all mounting positions on chassis and top deck must be in the front.

STANDARD (INITIAL SETTING)

As an initial setting use the long wheelbase is recommended for high-traction tracks or large, open tracks. The long wheelbase makes the car turn smoother, improves stability, and makes the car easier to drive.

SHORT

The short wheelbase is recommended for low- to medium-traction tracks or smaller technical tracks. The short wheelbase improves steering and rotation of the car.

1. FRONT SUSPENSION



4x 902306
SH M3x6

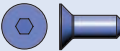

4x 903308
SFH M3x8

2x ALTERNATIVE 1

STANDARD TRACK-WIDTH (INITIAL SETTING)

Standard track-width setting is used for standard F1 front tires such HUDY, RIDE, HOT RACE.

To make sure that you use the correct setting, measure the track-width with the tires; the track-width must be maximum 190mm.

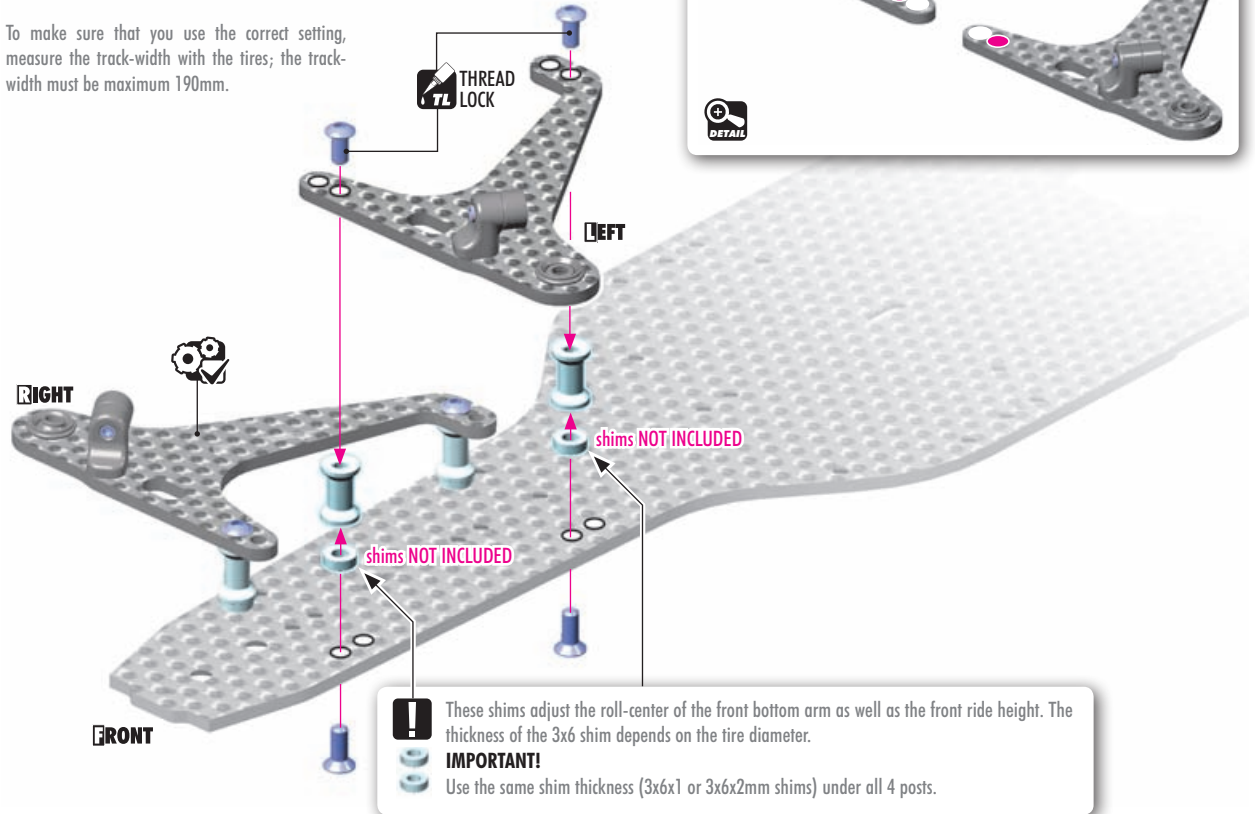

4x 902306
SH M3x6



4x 903308
SFH M3x8

2x ALTERNATIVE 2

WIDE TRACK-WIDTH

Wide track width setting used for narrow front tires such as Volante or foam tires.

To make sure that you use the correct setting, measure the track-width with the tires; the track-width must be maximum 190mm.

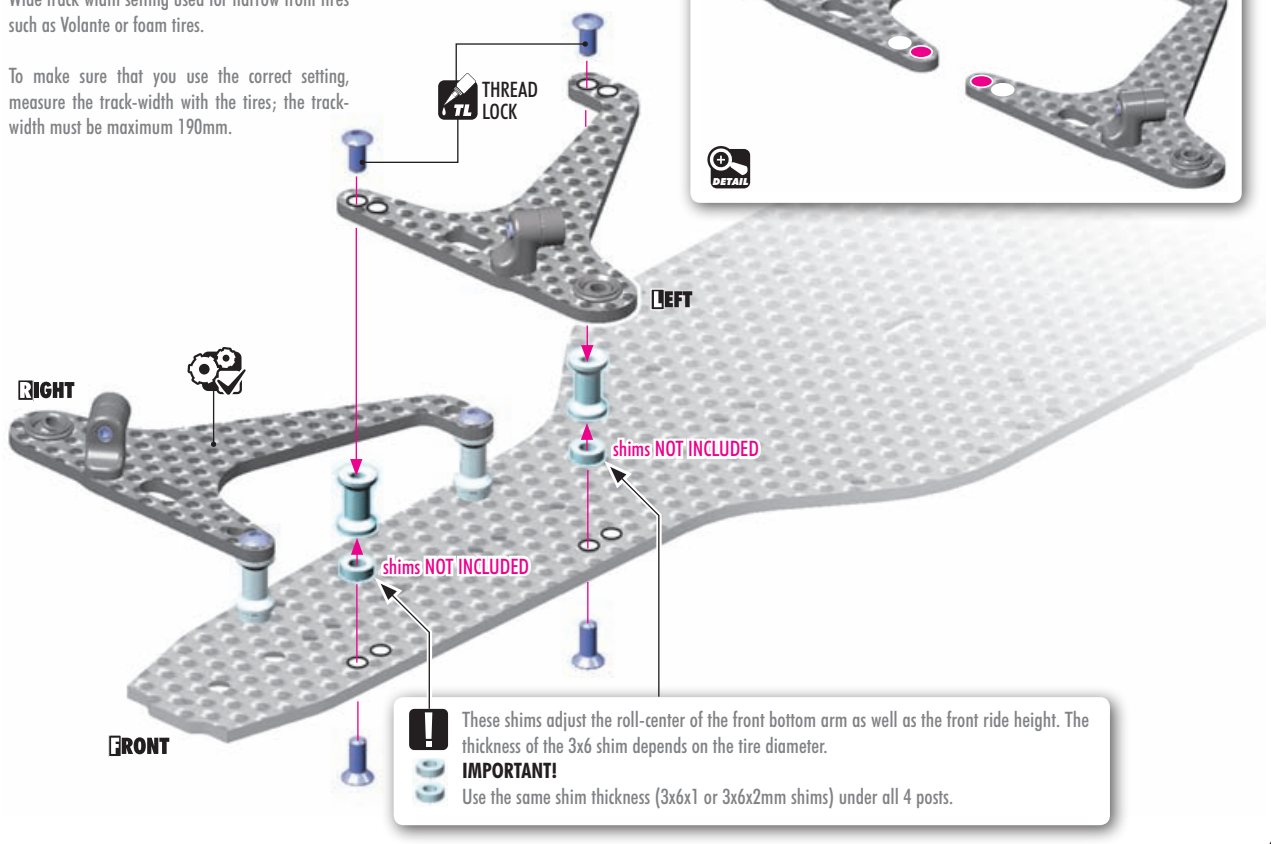

1. FRONT SUSPENSION



4x 902308
SH M3x8

NOTE ORIENTATION FOR ALL PARTS

IMPORTANT
All 4 bushings **MUST** have same orientation.

ALTERNATIVE 1 STANDARD TRACK-WIDTH (INITIAL SETTING)

Never use alu or titanium screws for the eccentric bushings.

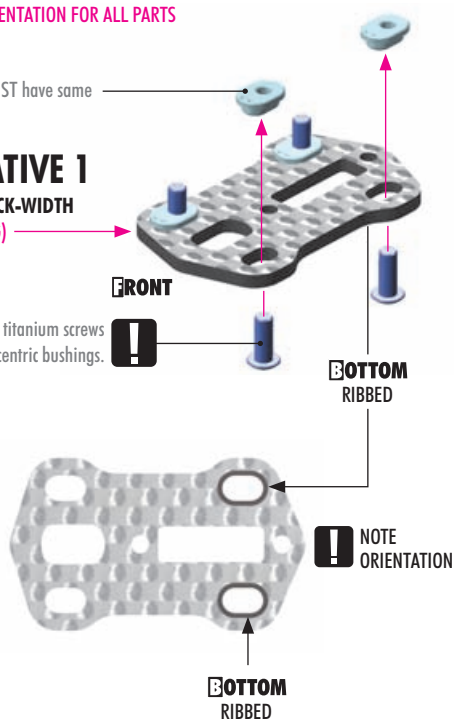

ALTERNATIVE 2 WIDE TRACK-WIDTH

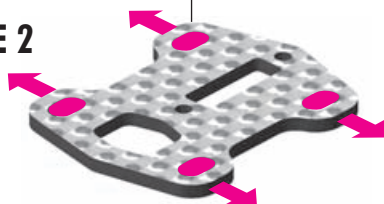

FRONT

- = 3° CASTER
- = 4.5° CASTER
- = 6° CASTER
- = 7.5° CASTER
- = 9° CASTER (INITIAL SETTING)
- = 10.5° CASTER

REAR

! All four bushings **MUST** have same orientation. These bushings adjust the front **CASTER**:

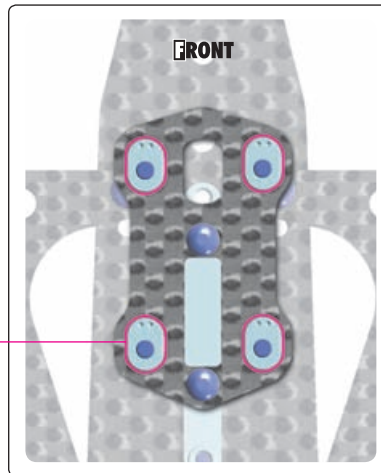

THESE ECCENTRIC BUSHINGS ADJUST THE FRONT **CASTER**.

MORE caster angle = better cornering speed, increased traction rolling. Use on large, open tracks where cornering speed is needed.

LESS caster angle = more reactive steering. Use on technical tracks where a lot of steering response is needed.

OPTION	ALU CASTER BUSHINGS		OPTION
#302310	3.0° / 10.5°	1 Dot	OPTION
#302311	4.5° / 9.0°	2 Dots	INCLUDED
#302312	6.0° / 7.5°	3 Dots	OPTION

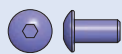

2x 902306
SH M3x6



2x 903306
SFH M3x6

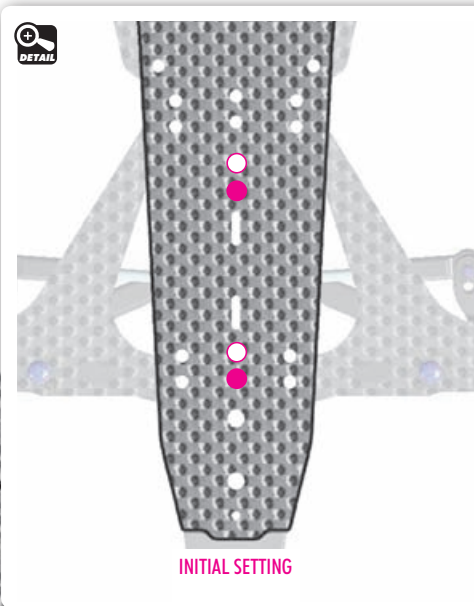
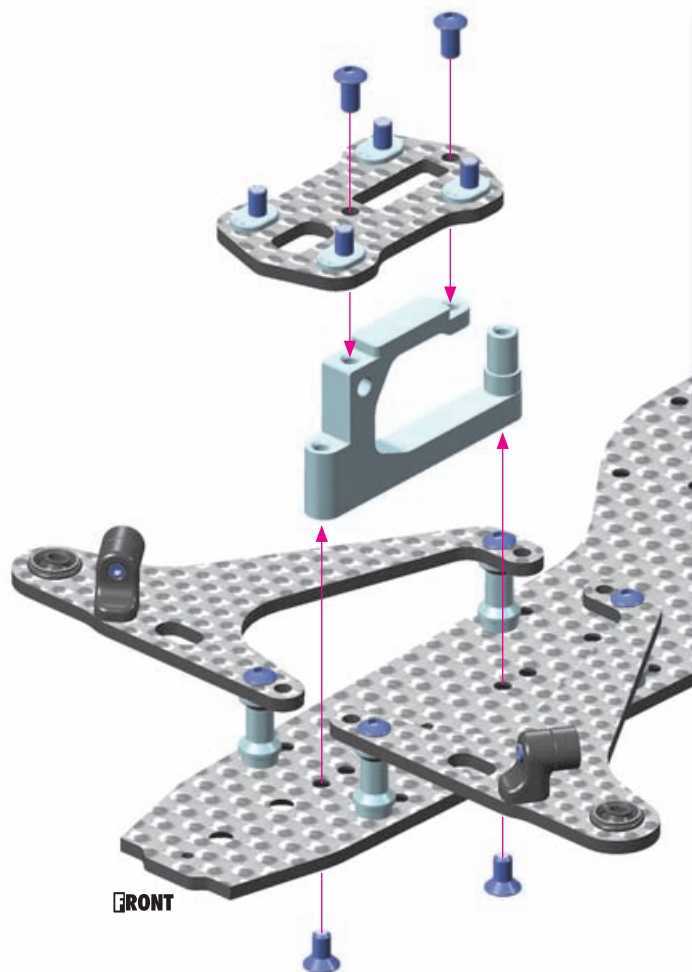

1. FRONT SUSPENSION

YOU CAN INSTALL A LOWER ARM BRACE TO INCREASE STEERING RESPONSE.

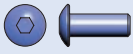

3x 902308
SH M3x8



1x 303122-K
SHIM 3x6x1

STEP 1:

To install the graphite brace remove the 3x6mm screws and graphite arm mount plate.

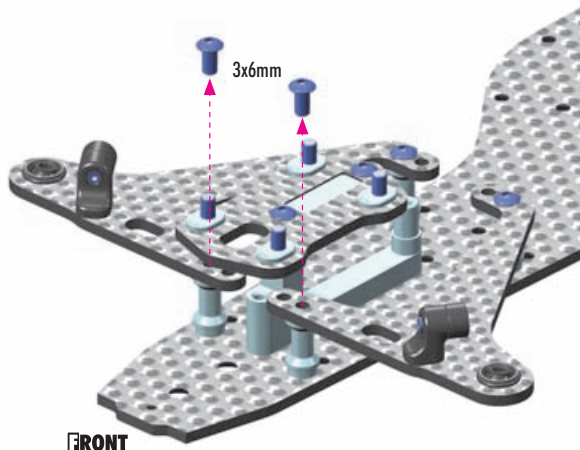

FRONT

STEP 2:

Install the graphite brace using 3x8mm screws. For stiff setting install also the 1mm shim.

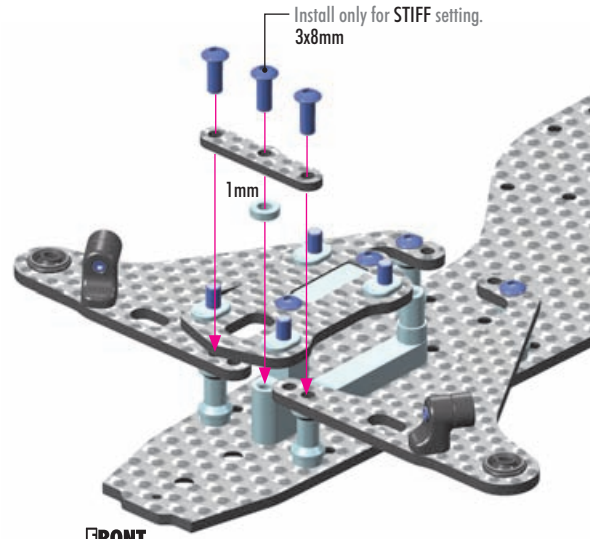

FRONT

SOFT - WITHOUT THE BRACE (INITIAL SETTING)

The car will have less initial steering. Recommended for high- and very-high-traction carpet tracks where the car needs to be easy to drive and less responsive.

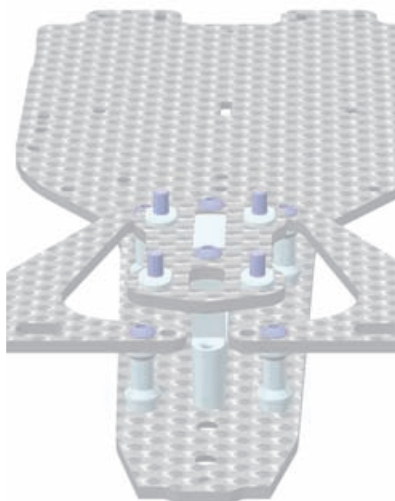

- BRACE (NOT USED)
- SHIM (NOT USED)

MEDIUM - WITH BRACE

Improves in-corner steering but still keeps the car easy to drive. Recommended for medium-high traction carpet tracks and high-traction asphalt tracks.

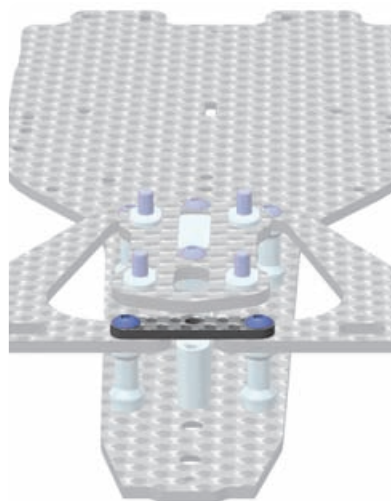

- BRACE USED
- SHIM (NOT USED)

STIFF - WITH BRACE AND CONNECTED TO ALU FRONT STAND

Provides maximum steering response. Recommended for low-medium traction carpet tracks and for all different traction conditions on asphalt tracks.

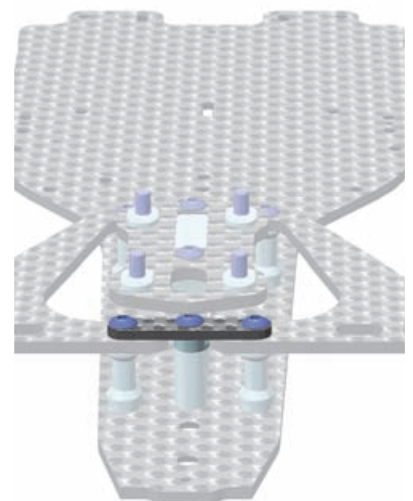

- BRACE USED
- SHIM USED

1. FRONT SUSPENSION

FRONT 2x

Push inside 1 Tighten 2

Apply Graphite Grease

31mm

2x

FRONT

RIGHT **LEFT**

BOTTOM VIEW

REAR

Check arm orientation so that each arm is in the correct location with the markings facing down when installed.

27mm for STANDARD track-width (INITIAL SETTING)
30mm for WIDE track-width

Shiny side Cut out

Ball joint should be aligned in the arm with the machined clearance facing down.

TIP Install the pivot balls with Professional Multi Tool (HUDY #183011).

When ADJUSTING CAMBER, keep the ball joint inline with the upper arm to insure free movement of the steering block.

RIGHT **LEFT**

FRONT

2x 901304 SB M3x4

2x **L-R**

BALL 4.9mm
THREAD 4mm

RIGHT **LEFT**

TIGHTEN GENTLY

There are THREE Ackermann positions on the steering block:

POSITION 3.

If using less bumpsteer shims on the steering plate and the steering linkage is touching the steering block, use 3x6x1mm composite shim (BAG 5).

3x6x1mm

05

1 - easiest to drive
2 - improved steering response
3 - improved overall steering

1. FRONT SUSPENSION



8x 303141 SHIM 3x5x1



20x 372290 SHIM 3.2x4.8x0.5



4x 965019 C 1.9

2x L=R

HUDY
RECOMMENDED
HUDY SILICONE OIL

LOW traction & bumpy track:
10K cSt (#106510 HUDY)

HIGH traction & flat track:
30K cSt (#106530 HUDY)

DAMPING

Using thicker oil on the king pin axles makes the car less responsive but easier to drive. Thicker oil increases stability but decreases cornering speed.

FREE MOVEMENT



RIGHT

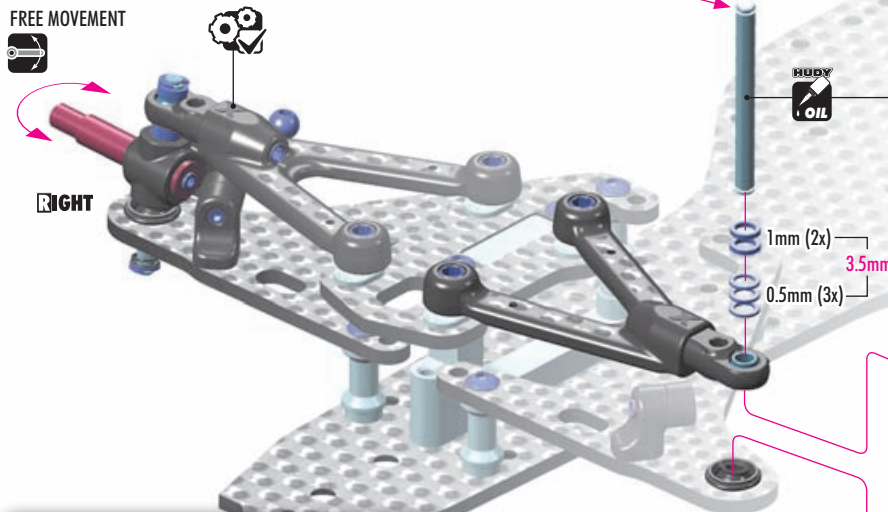

The number of the shims affects the front ride height. Determine the proper amount of shimming based on tire diameter.

LEFT



FRONT COIL SPRINGS

#372176	C=1.5 GOLD	OPTION
#372177	C=2.0 SILVER	INCLUDED
#372178	C=2.5 BLACK	OPTION
#372179	C=3.0 GREY	OPTION
#372180	C=3.5 GOLD	OPTION
#372181	C=4.0 SILVER	OPTION
#372182	C=5.0 BLACK	OPTION
#372183	C=5.5 GREY	OPTION



SOFTER SPRINGS

Makes the car easier to drive over bumps and increases steering as it makes the car roll more, especially in the middle of a corner.

HARDER SPRINGS

Makes the car more responsive and increases initial steering. Recommended for high-traction and flat tracks.

2x L=R

After assembling the steering block, do the following:

1. Loosen the set-screw slightly.
2. Use your thumb to press down on the top of the kingpin, while using your other fingers to pull up the steering block.
3. Tighten the set-screw.

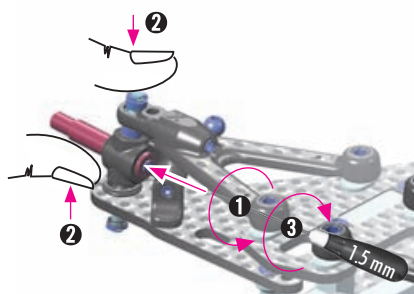

TIP

JAN RATHERSKY (factory driver)

We use different ride heights at indoor and outdoor tracks:

- **INDOOR:** Ride height is as low as the rules allow, usually 4mm.
- **OUTDOOR:** Always run at least 5mm ride height.

Rear ride height should always be 0.1-0.2mm higher than the front.

I recommend changing droop using the upper shims on the kingpin, but note that this also changes the ride height by the same amount. Adding +0.5mm shim means 0.5mm less droop because the spring gets more preload which results in a higher ride height. In that case, you should add the same amount (0.5mm) under the lower wishbone.

DROOP SETTING

INDOOR:

I recommend using a small amount of droop for carpet tracks, somewhere between 0.5-1mm to get the most on-power steering in combination with solid reactive steering.

OUTDOOR:

You should use more droop for asphalt tracks. At least 1mm up to 2mm. The more droop, the more on-power rear traction you get because of weight transfer to the rear. It also helps to get a more smooth-to-drive car at corner entry.

2. REAR SUSPENSION

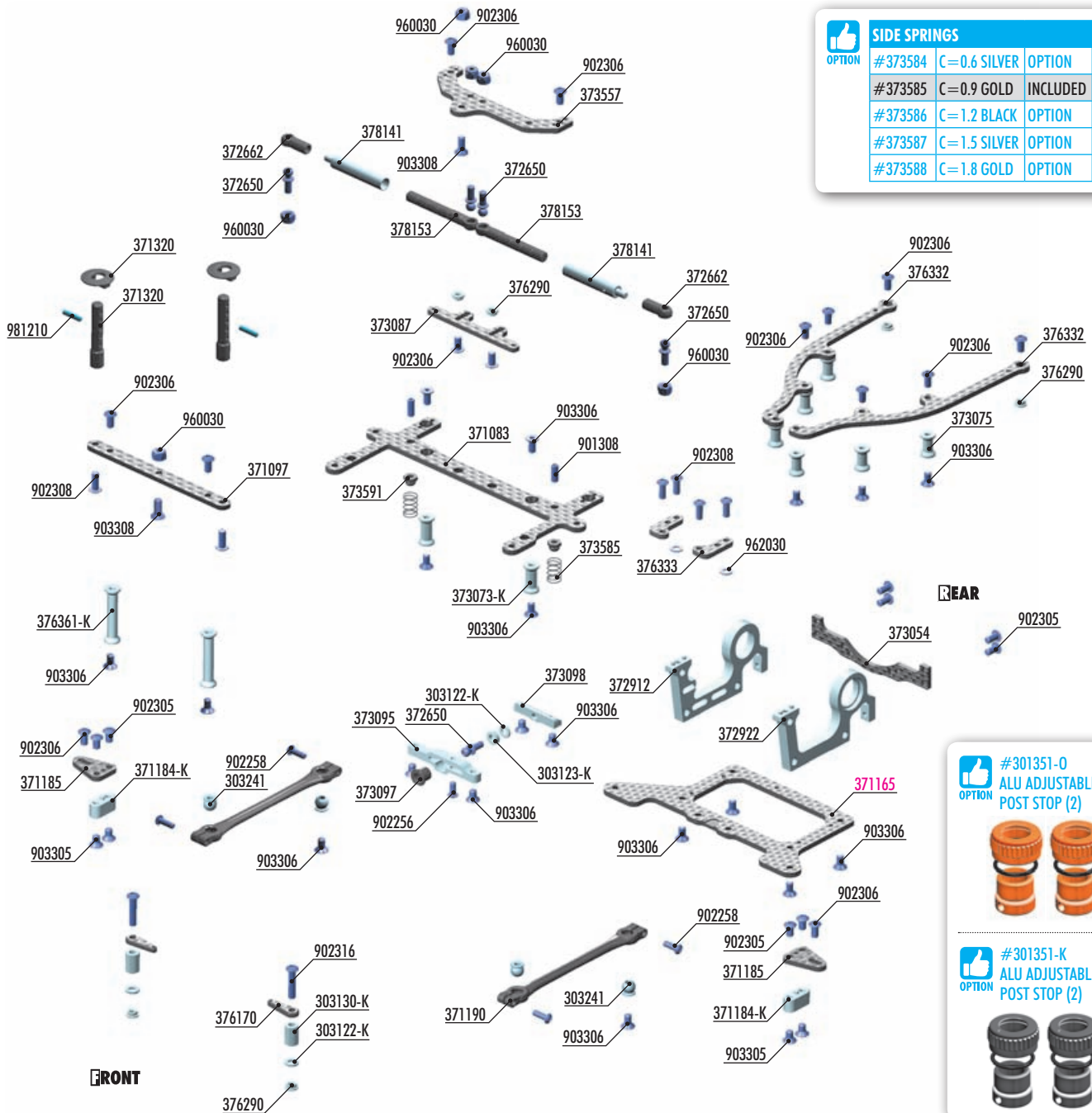

OPTION	#	C	COLOR	STATUS
	#373584	C=0.6	SILVER	OPTION
	#373585	C=0.9	GOLD	INCLUDED
	#373586	C=1.2	BLACK	OPTION
	#373587	C=1.5	SILVER	OPTION
	#373588	C=1.8	GOLD	OPTION

#301351-0
ALU ADJUSTABLE BODY POST STOP (2)

#301351-K
ALU ADJUSTABLE BODY POST STOP (2)



- 303122-K ALU SHIM 3x6x1.0mm - BLACK (10)
- 303123-K ALU SHIM 3x6x2.0mm - BLACK (10)
- 303130-K ALU SHIM 3x6x9.0mm - BLACK (10)
- 303241 PIVOT BALL UNIVERSAL 5.8mm WITH HEX (4)
- 371083 GRAPHITE REAR BRACE 2.5mm
- 371097 GRAPHITE PLATE FOR MOUNTS 2.2mm
- 371184-K ALU POD LINK GRAPHITE PLATE HOLDER - BLACK
- 371185 GRAPHITE POD LINK PLATE 2.2mm (2)
- 371190 COMPOSITE POD LINK (2)
- 371320 COMPOSITE BODY POST (2)
- 372650 BALL END 4.2mm WITH 6mm THREAD (2)
- 372662 COMPOSITE BALL-JOINT 4.2mm (4)
- 372912 ALU REAR BULKHEAD - MOTOR (RIGHT)
- 372922 ALU REAR BULKHEAD - LEFT
- 373054 GRAPHITE REAR BULKHEAD BRACE 2.5mm
- 373073-K ALU REAR BRACE MOUNT 13mm - BLACK (2)
- 373075 ALU REAR BRACE MOUNT 10.5mm - BLACK (2)
- 373087 GRAPHITE BATTERY BACKSTOP 2.2mm - V2
- 373095 ALU CHASSIS PIVOT HOLDER - SWISS 7075 T6
- 373097 COMPOSITE PIVOT BRACE BUSHING
- 373098 ALU POD PLATE PIVOT HOLDER - SWISS 7075 T6
- 373557 GRAPHITE REAR POD UPPER PLATE 2.5mm
- 373585 SIDE SPRING C=0.9 - GOLD (2)
- 373591 COMPOSITE SIDE SPRING HOLDER (2)
- 376170 GRAPHITE BATTERY CLAMP 2.2mm (2)
- 376290 LOW PROFILE ALU SELF-LOCKING NUT (2)
- 376332 SIDE BRACE - GRAPHITE 2.5mm (2)
- 376333 ARM SIDE BRACE - GRAPHITE 2.5mm (2)
- 376361-K ALU MOUNT 26.5mm - BLACK (2)
- 378141 SIDE LINKAGE TUBE (2)
- 378153 COMPOSITE LINKAGE SHAFT (2)
- 901308 HEX SCREW SB M3x8 (10)
- 902256 HEX SCREW SH M2.5x6 (10)
- 902258 HEX SCREW SH M2.5x8 (10)
- 902305 HEX SCREW SH M3x5 (10)
- 902306 HEX SCREW SH M3x6 (10)
- 902308 HEX SCREW SH M3x8 (10)
- 902316 HEX SCREW SH M3x16 (10)
- 903305 HEX SCREW SFH M3x5 (10)
- 903306 HEX SCREW SFH M3x6 (10)
- 903308 HEX SCREW SFH M3x8 (10)
- 960030 NUT M3 (10)
- 962030 WASHER S 3x6x0.3 (10)
- 981210 PIN 2x10 (10)
- 371165 GRAPHITE REAR POD LOWER PLATE 2.5mm

Numbers in parentheses () refer to quantities when purchased separately.

2. REAR SUSPENSION

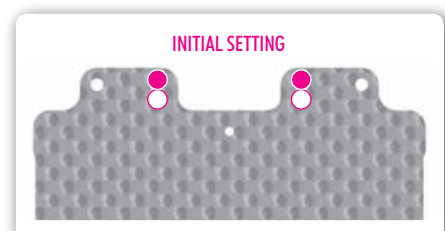
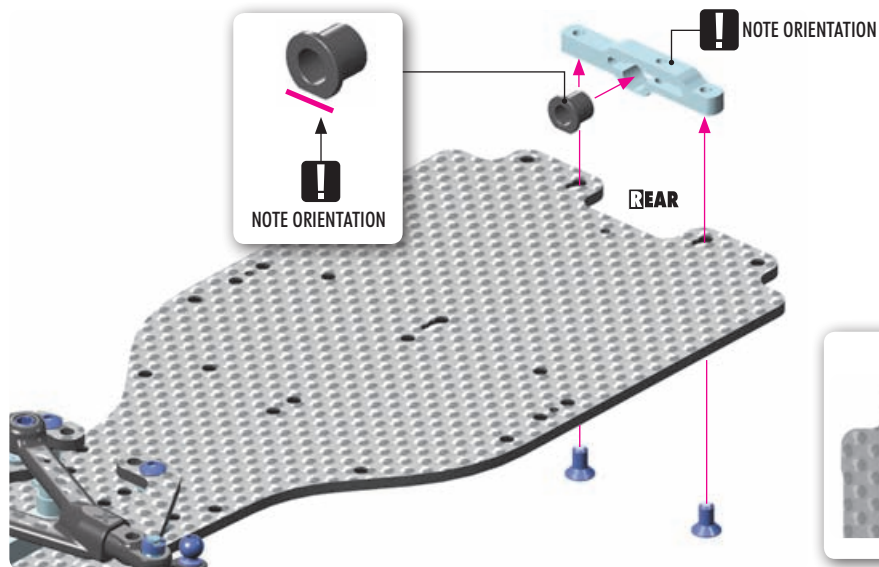
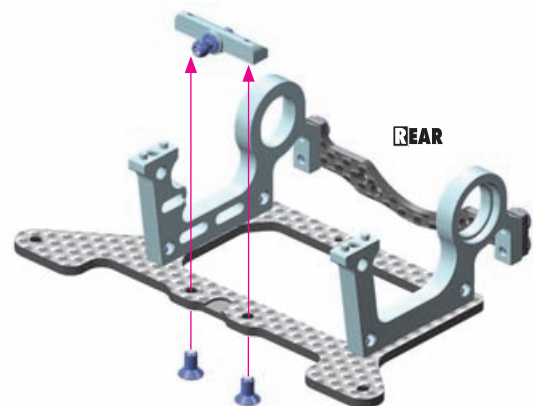
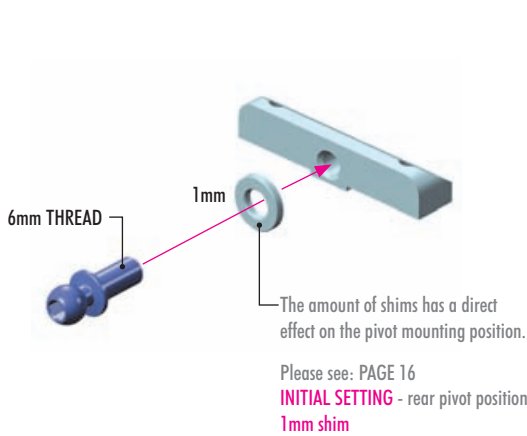
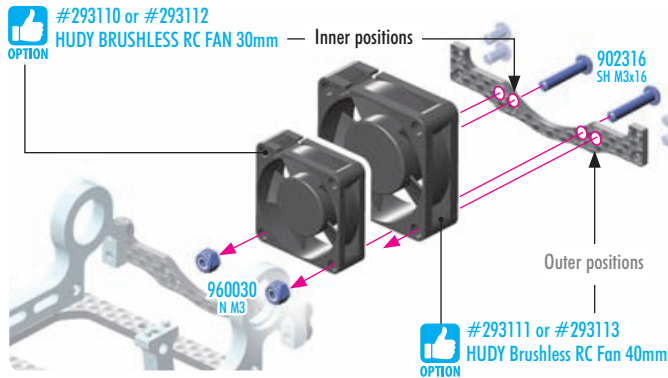
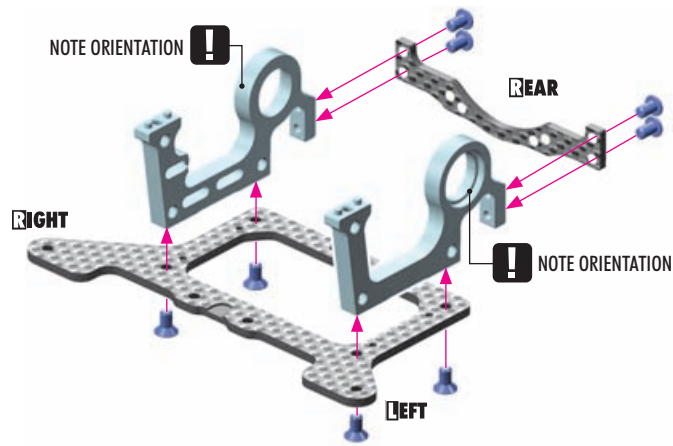

2. REAR SUSPENSION

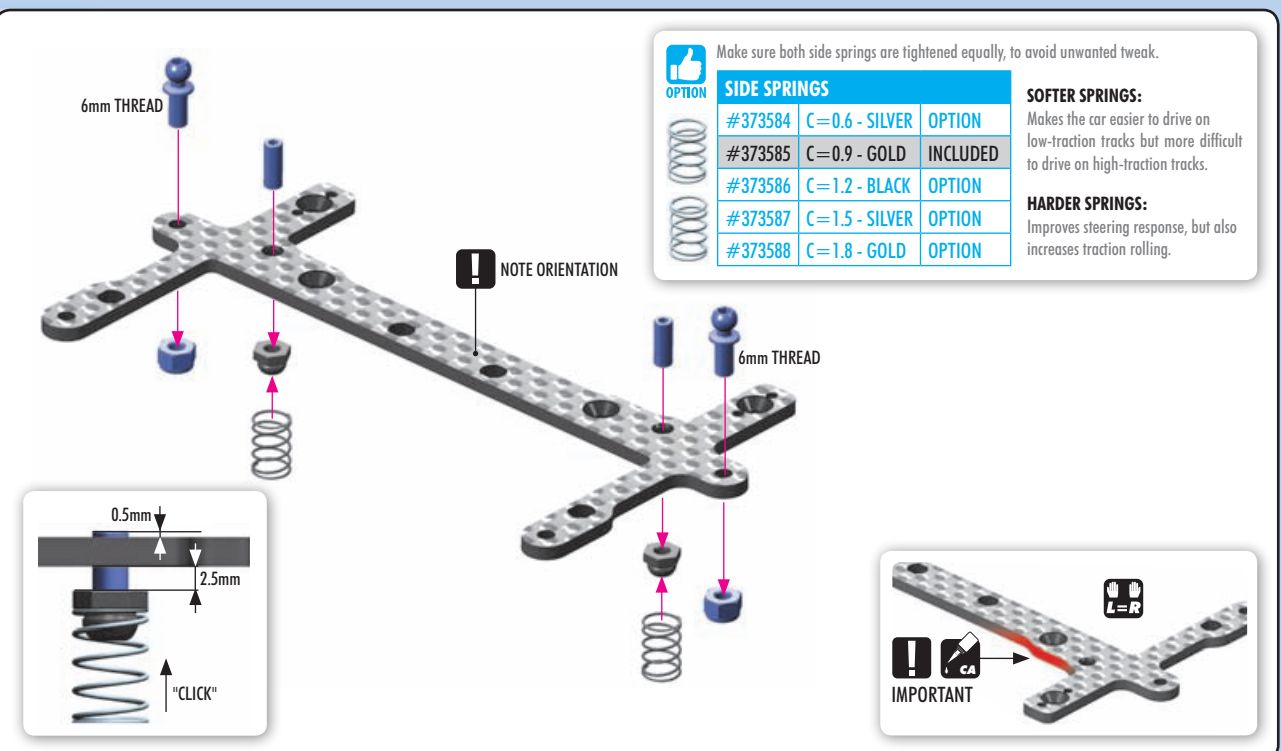
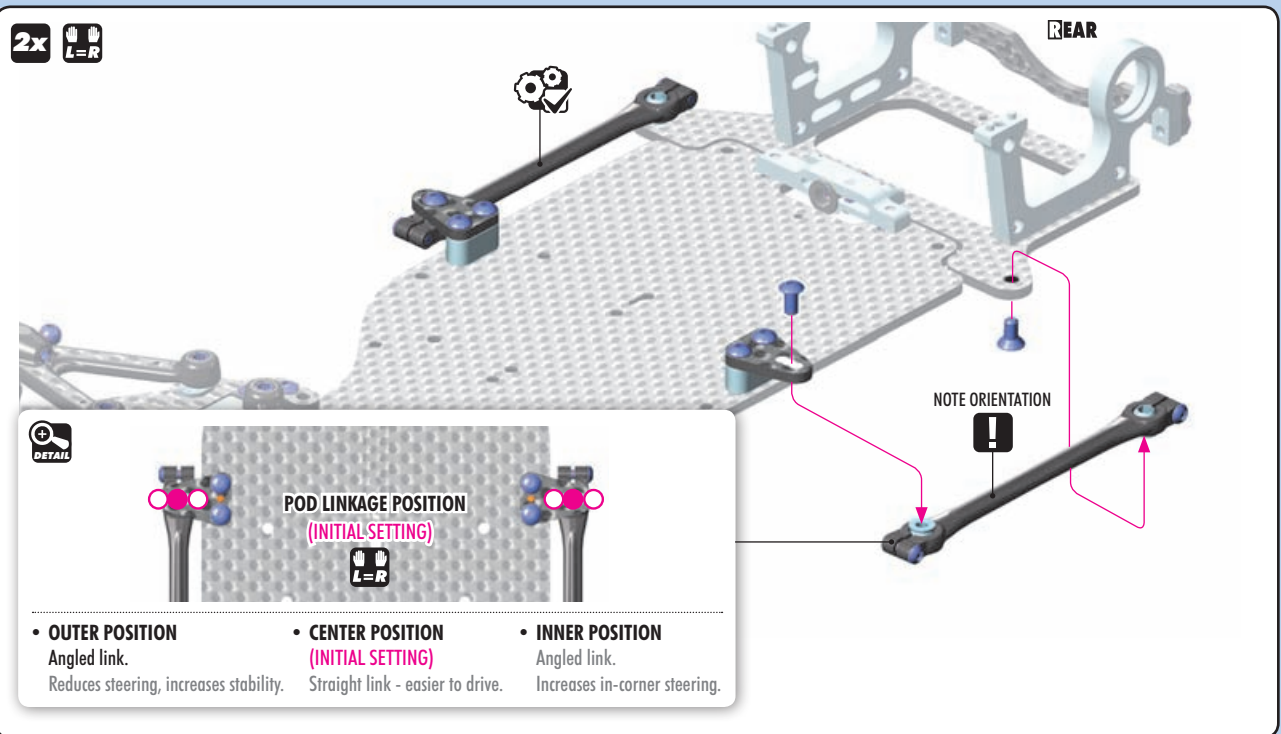
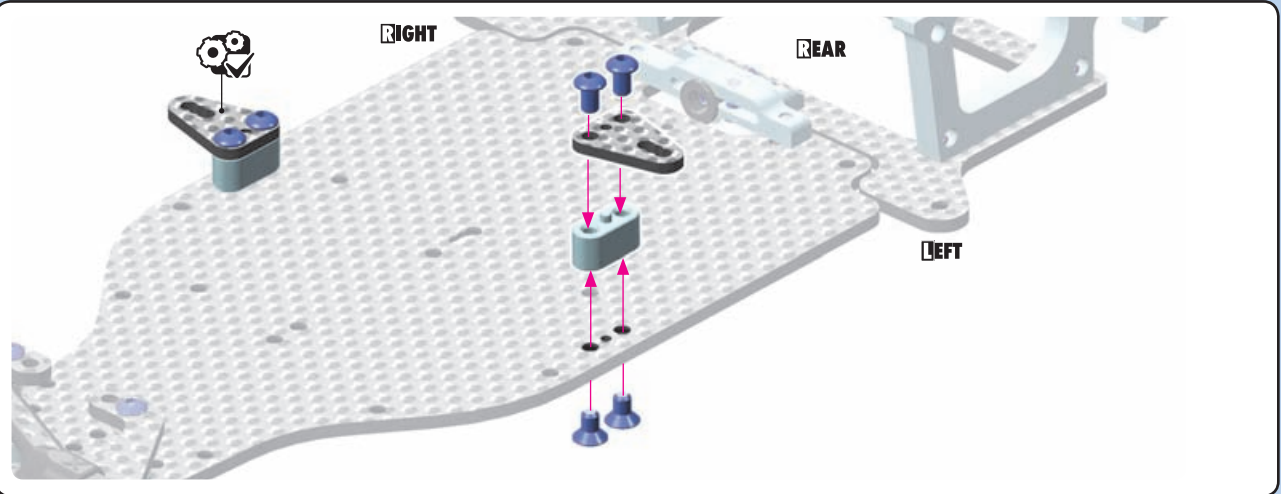

2. REAR SUSPENSION



2x 303122-K
SHIM 3x6x1



2x 303130-K
SHIM 3x6x9

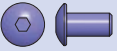

2x 902306
SH M3x6



2x 902316
SH M3x16

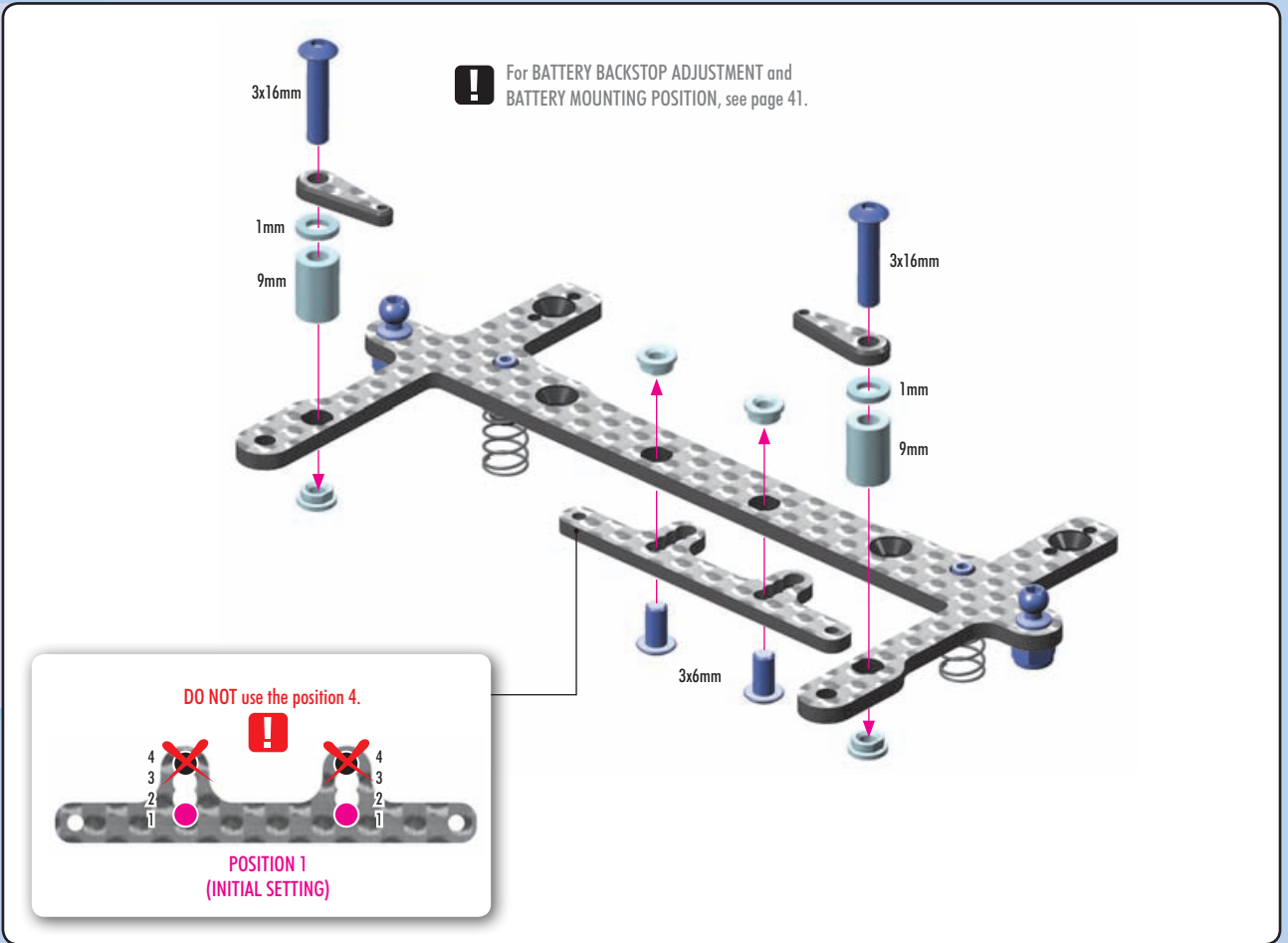

4x 903306
SFH M3x6

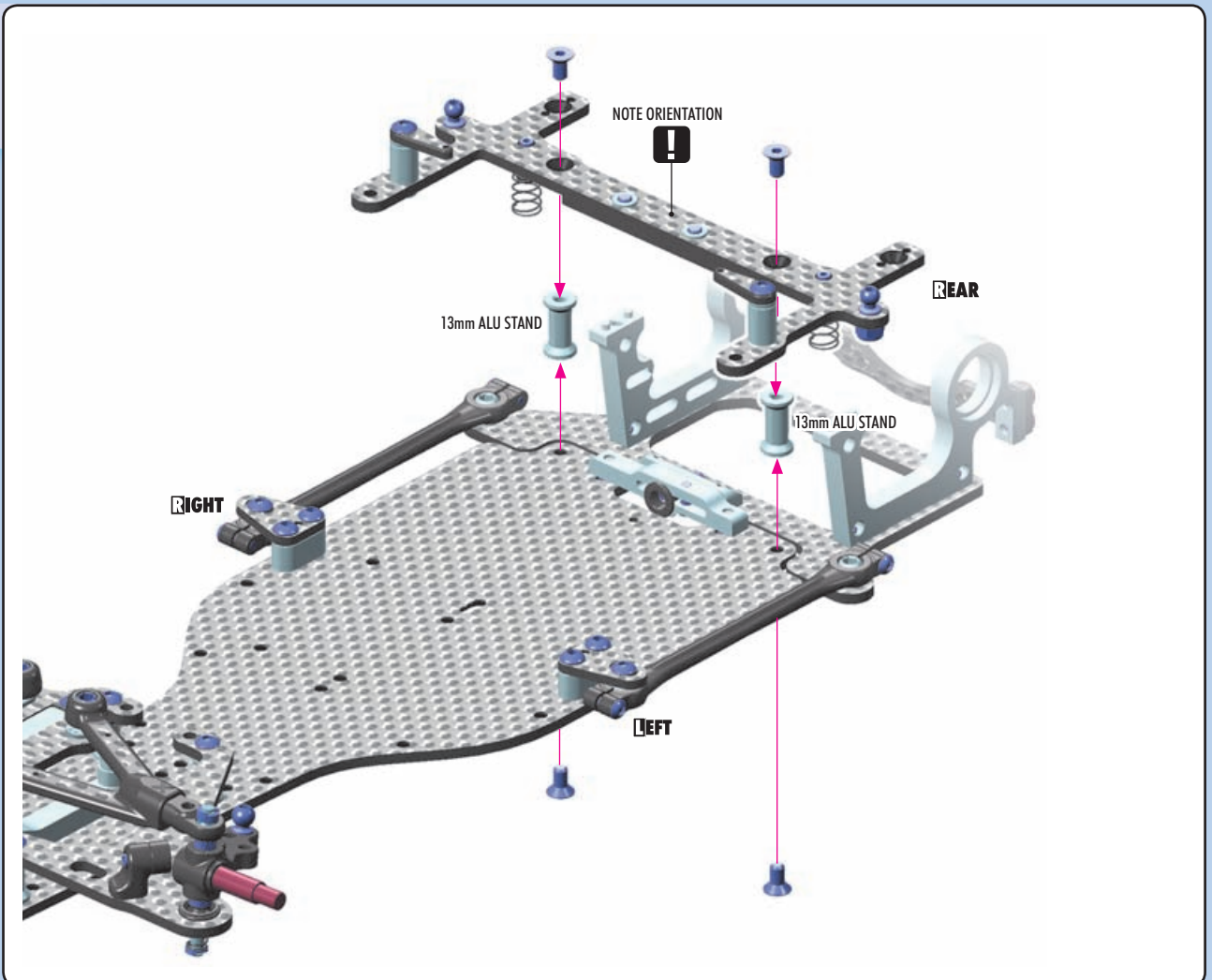

2. REAR SUSPENSION

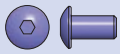

2x 902306
SH M3x6



1x 903308
SFH M3x8



3x 960030
N M3

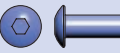
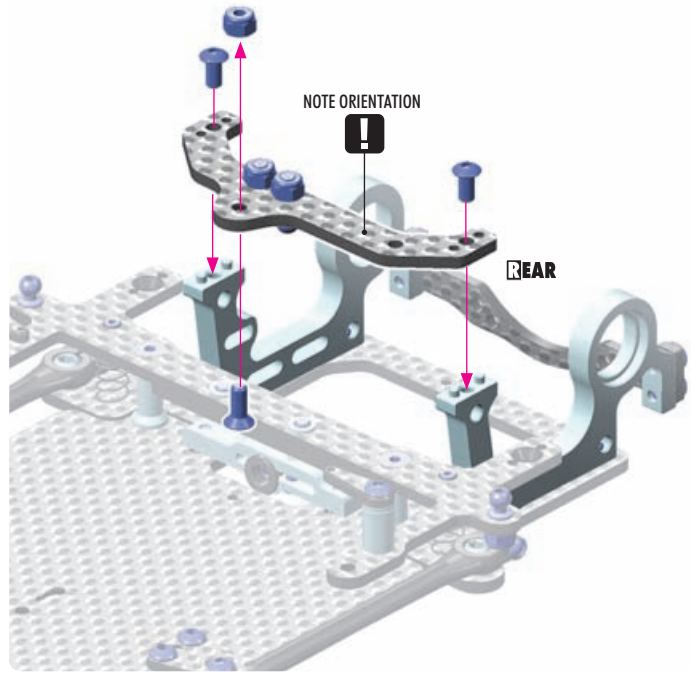
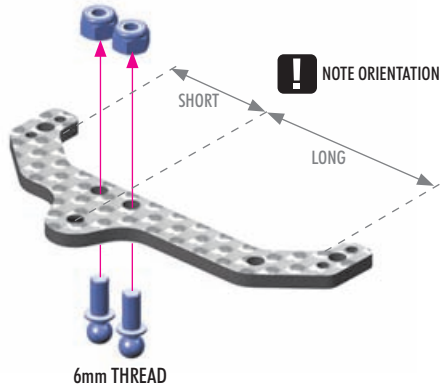

2x 902308
SH M3x8

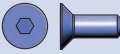

1x 903308
SFH M3x8



1x 960030
N M3

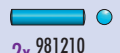

2x 981210
P 2x10

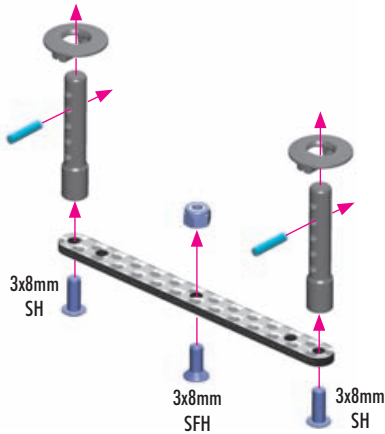

#301351-0
ALU ADJUSTABLE BODY
POST STOP (2)
OPTION

#301351-K
ALU ADJUSTABLE BODY
POST STOP (2)
OPTION



Very handy, easily externally-adjustable body post made from Swiss 7075 T6 aluminum. Allows for adjustment of body height by 3mm without needing to change the position on the body post.



2x 902306
SH M3x6



2x 903306
SFH M3x6

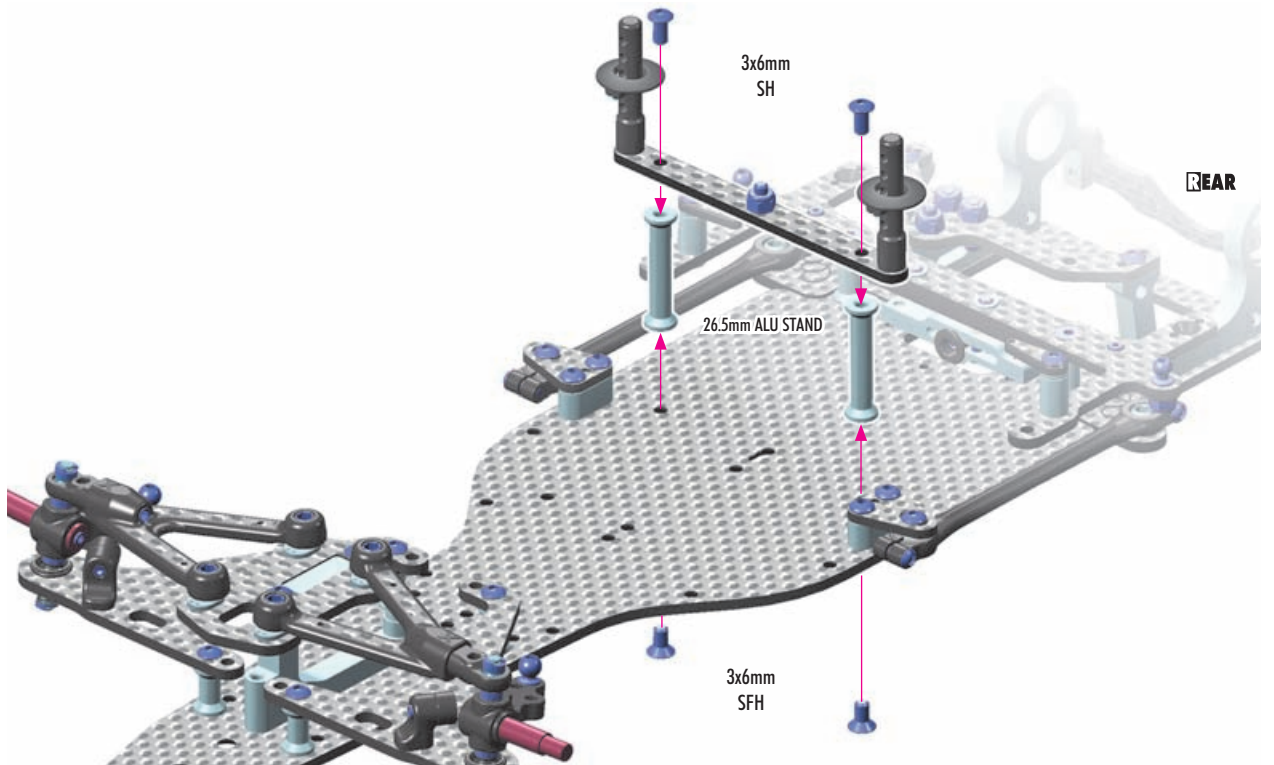

2. REAR SUSPENSION

2x

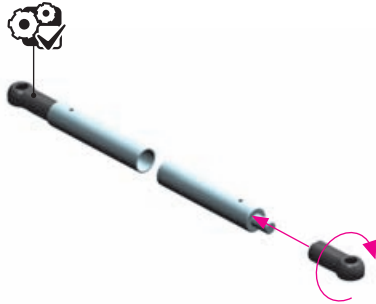

2x

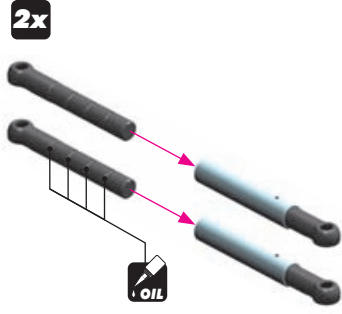

Add oil in each slot of the COMPOSITE side tubes.

NOTE:
Add oil only in the slots, not on the whole tube.
After assembling the side tubes, check for smooth operation.
It is very important to re-oil the side tubes, at least once per race day.
You may use different oil thicknesses depending on track conditions.

TIP

For HIGH grip	use SOFTER oils
For LOW grip or ASPHALT	use HARDER oils

HUDY OILS

#	Price	Status
#106510	10.000:€†	OPTION
#106492	11.000:€†	OPTION
#106512	12.000:€†	OPTION
#106515	15.000:€†	OPTION
#106520	20.000:€†	OPTION
#106530	30.000:€†	INCLUDED
#106540	40.000:€†	OPTION
#106550	50.000:€†	OPTION

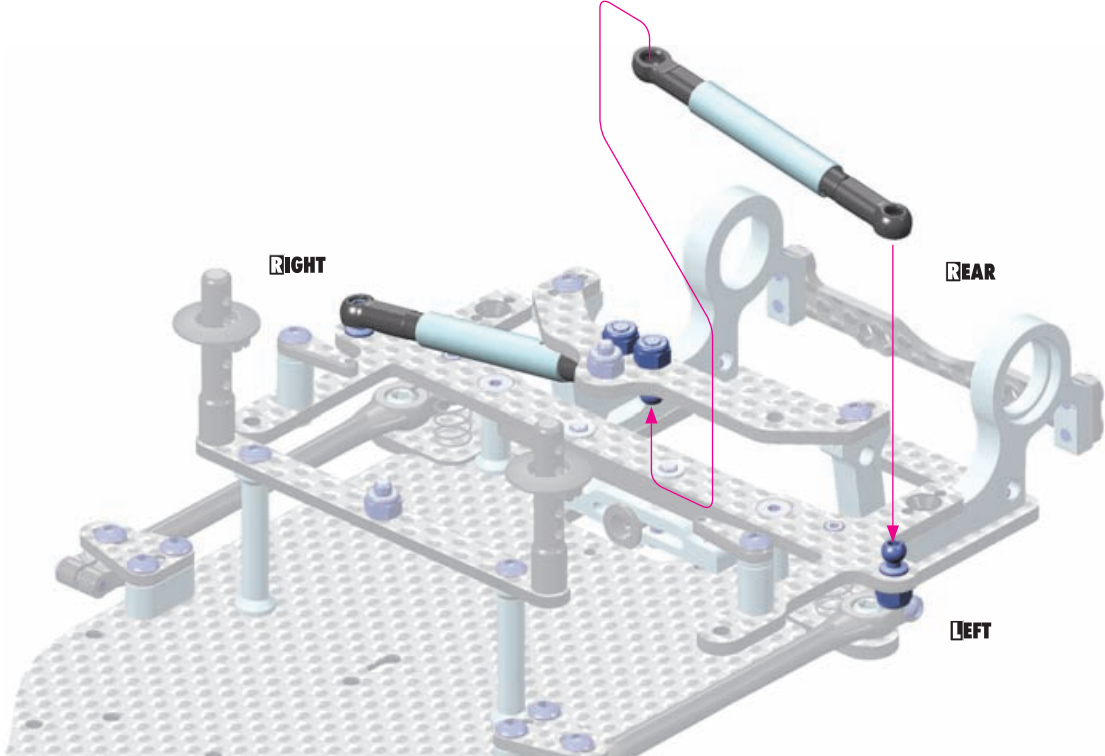

TIP SIDE TUBE ANGLE

The angle of the side tubes has a fine effect on car performance. The angle is adjusted with shims between the pivot ball and the rear brace and/or upper plate.

The **HIGHER** the angle, the stiffer it feels and the less it rolls.
The **LESS** (flatter) the angle, the softer it feels and the more it rolls.

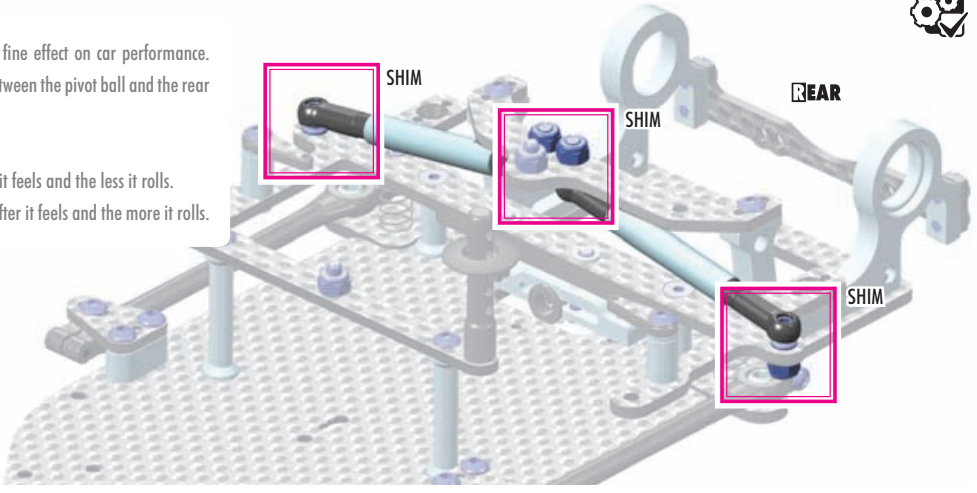

2. REAR SUSPENSION

OPTIONAL SIDE SHOCK



#378100

Optional side shock can be used to improve traction in low- and medium-traction conditions.
The optional side shock REPLACES the 2 side tubes.

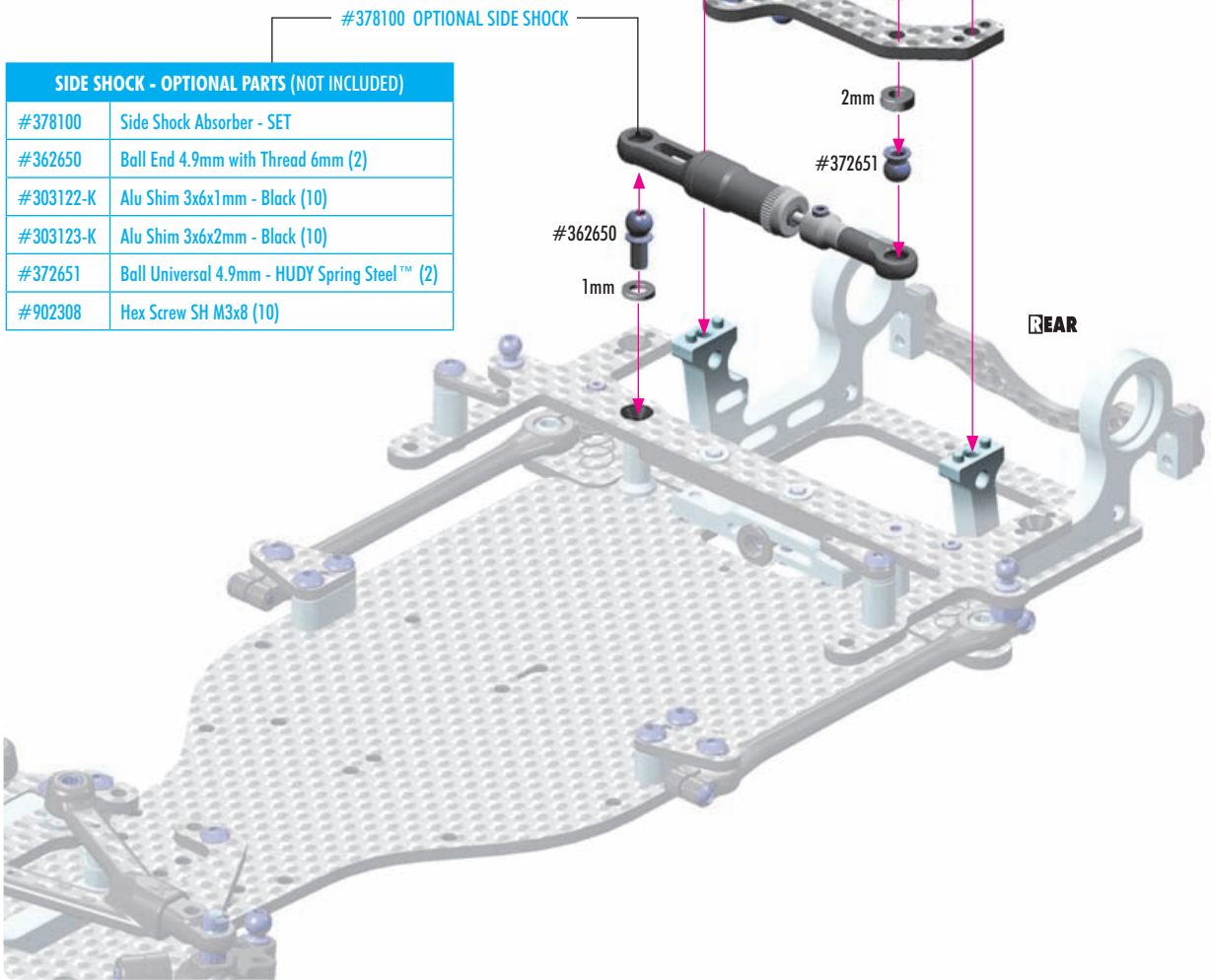

SIDE SHOCK - OPTIONAL PARTS (NOT INCLUDED)	
#378100	Side Shock Absorber - SET
#362650	Ball End 4.9mm with Thread 6mm (2)
#303122-K	Alu Shim 3x6x1mm - Black (10)
#303123-K	Alu Shim 3x6x2mm - Black (10)
#372651	Ball Universal 4.9mm - HUDY Spring Steel™ (2)
#902308	Hex Screw SH M3x8 (10)



6x 903306
SFH M3x6

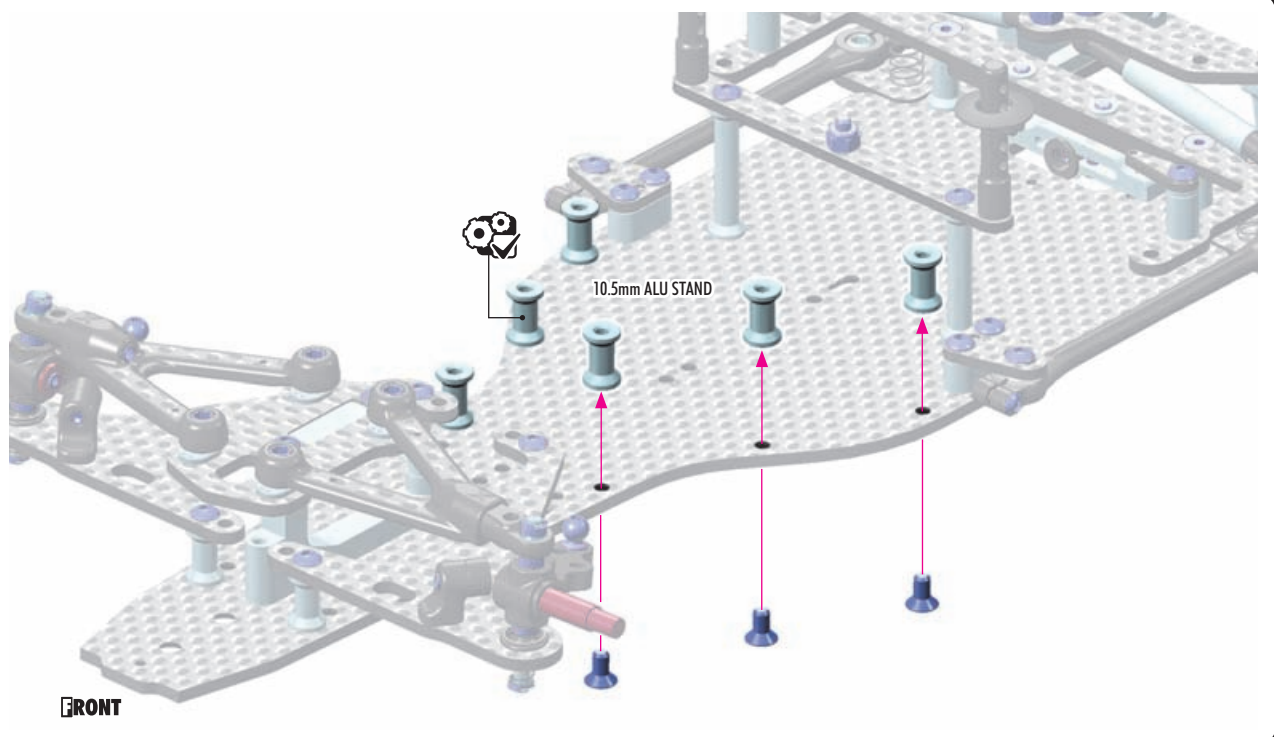

2. REAR SUSPENSION

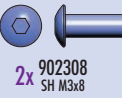

IMPORTANT

Most popular formula bodies will clear the side braces. If a body does not have adequate clearance in the front nose area, installation may require body modification or removal of the side braces.

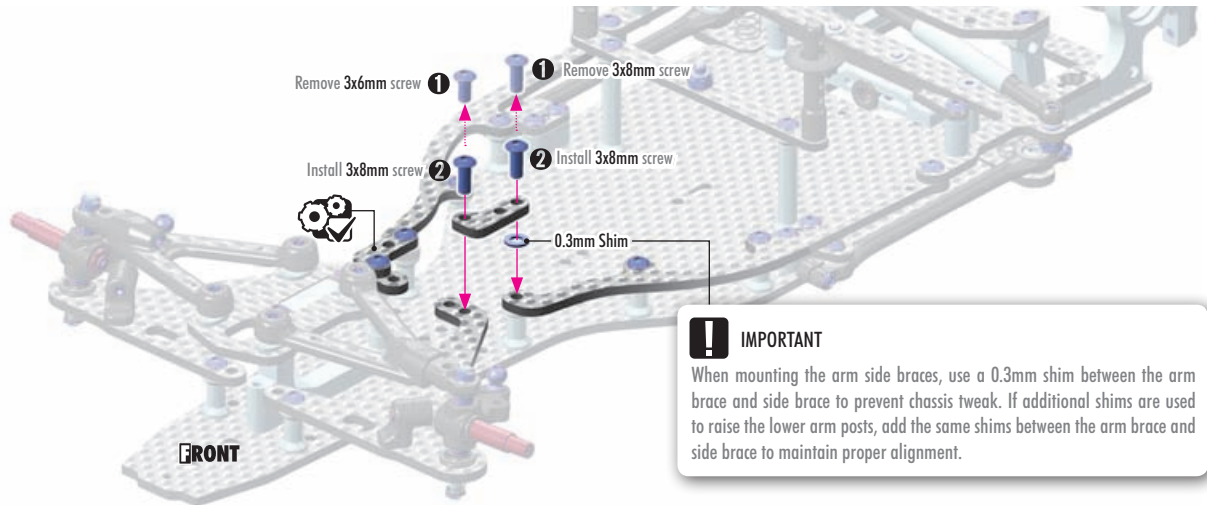
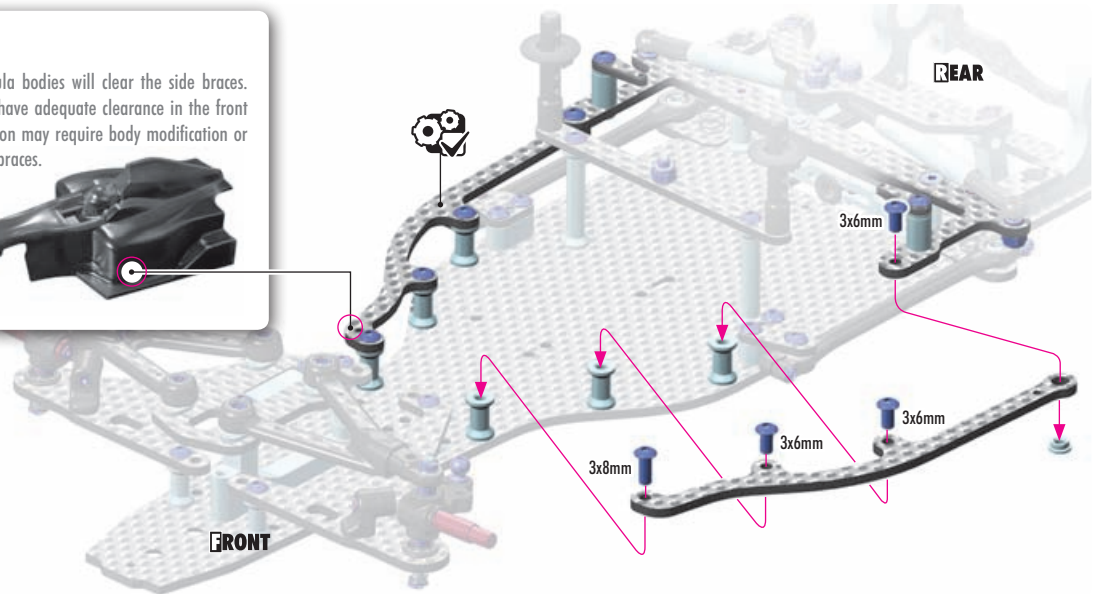

IMPORTANT

When mounting the arm side braces, use a 0.3mm shim between the arm brace and side brace to prevent chassis tweak. If additional shims are used to raise the lower arm posts, add the same shims between the arm brace and side brace to maintain proper alignment.

CHASSIS FLEX ADJUSTMENT

SOFT (NO BRACES)

Generates more mechanical grip. Recommended for low- to medium-traction carpet as well as asphalt.

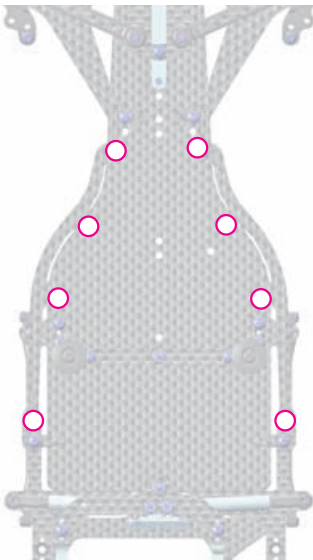

MEDIUM

Braces installed, attached at middle & rear only. This setting is a good compromise between mechanical grip and steering response. Ideal for most conditions.



STIFF

Side braces installed, attached using front, front-middle, middle, and rear screws. This setting provides additional stiffness and more stability. Recommended for high traction carpet (ex: US black carpet). Reduces chassis roll but also reduces overall grip. Recommended for foam tire racing.



EXTRA STIFF

Side braces installed, attached using front, front-middle, middle, and rear screws. Front arm braces are installed between lower arms and side braces. This setting provides maximum chassis stiffness and stability. Recommended for foam tire racing.

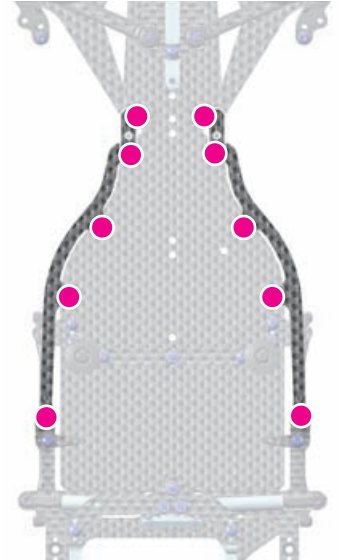

3. GEAR DIFFERENTIAL

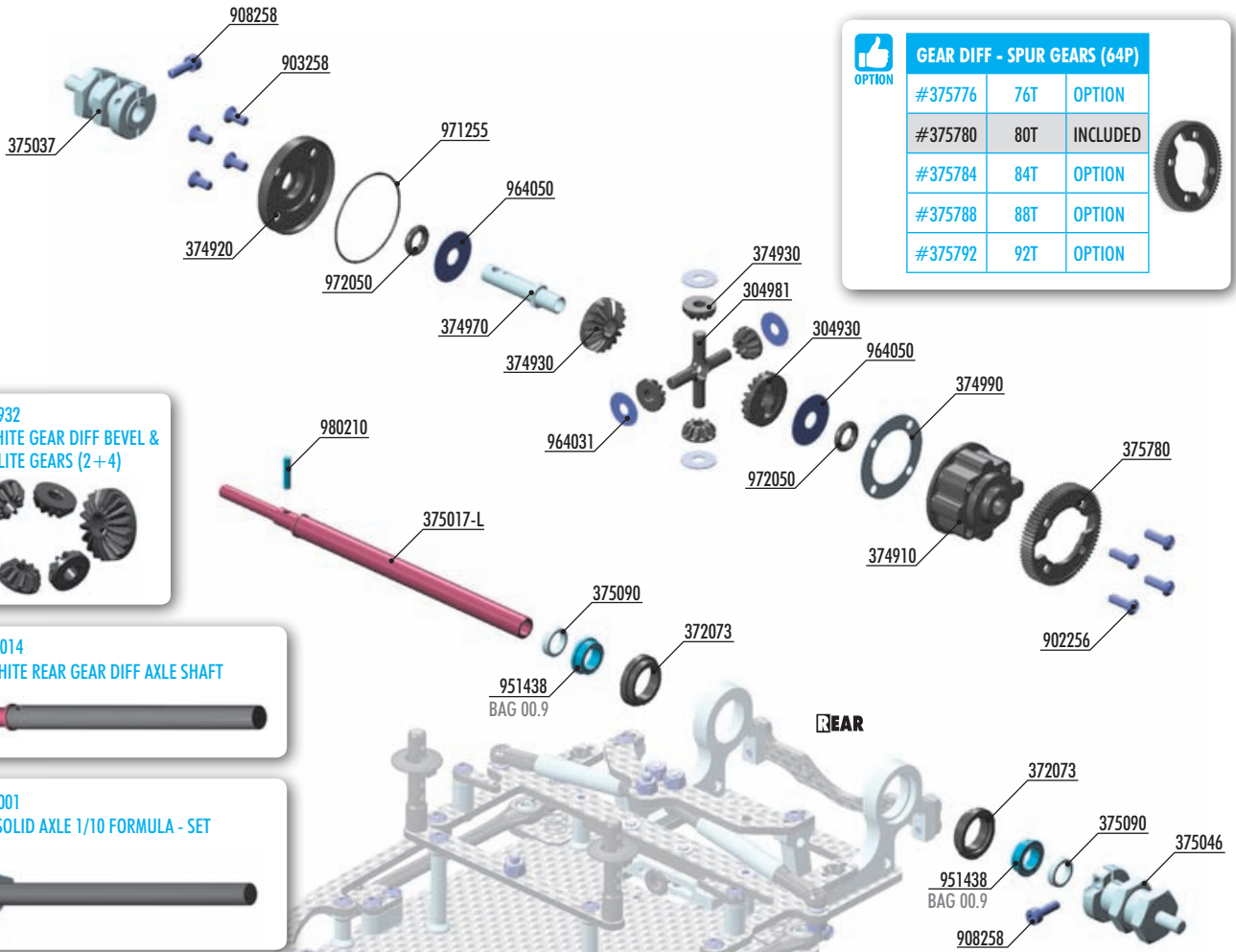

OPTION

GEAR DIFF - SPUR GEARS (64P)		
#375776	76T	OPTION
#375780	80T	INCLUDED
#375784	84T	OPTION
#375788	88T	OPTION
#375792	92T	OPTION

OPTION

#304932
GRAPHITE GEAR DIFF BEVEL & SATELLITE GEARS (2+4)

OPTION

#375014
GRAPHITE REAR GEAR DIFF AXLE SHAFT

OPTION

#375001
XRAY SOLID AXLE 1/10 FORMULA - SET

OPTION

BALL DIFFERENTIAL

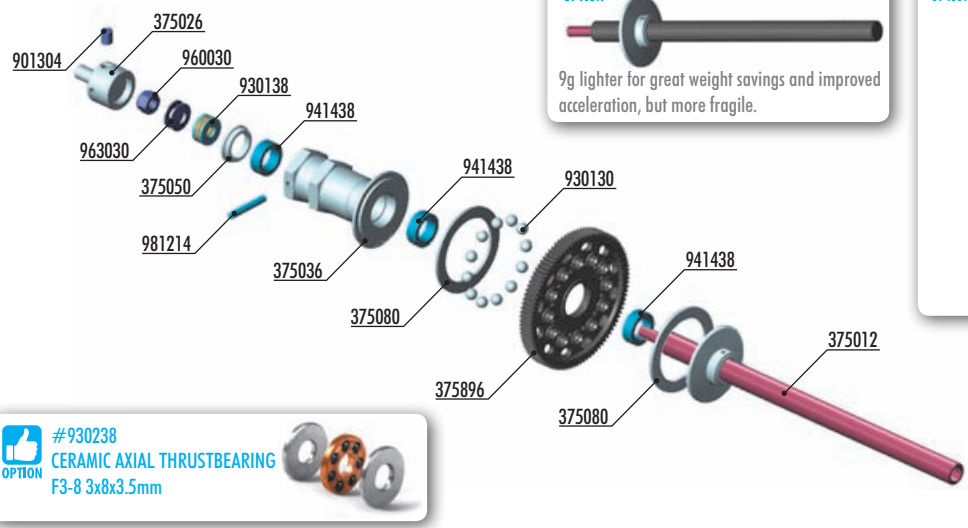

OPTION

#375010
GRAPHITE REAR AXLE SHAFT

9g lighter for great weight savings and improved acceleration, but more fragile.

OPTION

BALL DIFF - SPUR GEARS		
#375872	72T / 64P	OPTION
#375875	75T / 64P	OPTION
#375876	76T / 64P	OPTION
#375878	78T / 64P	OPTION
#375880	80T / 64P	OPTION
#375884	84T / 64P	OPTION
#375888	88T / 64P	OPTION
#375892	92T / 64P	OPTION
#375896	96T / 64P	OPTION

OPTION

#930230
CERAMIC BALL 3.175mm (12)

OPTION

#930238
CERAMIC AXIAL THRUSTBEARING
F3-8 3x8x3.5mm



- | | | | |
|----------|---|--------|--|
| 304930 | COMPOSITE GEAR DIFF BEVEL & SATELLITE GEARS (2+4) | 375090 | SET OF ALU SHIMS 6.37x8.4mm (0.5mm, 1.0mm, 2.0mm) |
| 304981 | COMPOSITE GEAR DIFF CROSS PIN WITH HOLE | 375780 | COMPOSITE GEAR DIFF SPUR GEAR - 80T / 64P |
| 372073 | COMPOSITE ECCENTRIC RIDE HEIGHT ADJUSTER SET (2) | 902256 | HEX SCREW SH M2.5x6 (10) |
| 374901 | XRAY GEAR DIFFERENTIAL 1/10 FORMULA - SET | 903258 | HEX SCREW SFH M2.5x8 (10) |
| 374910 | COMPOSITE GEAR DIFFERENTIAL CASE - GRAPHITE | 908258 | HEX SCREW SOCKET HEAD CAP M2.5x8 (10) |
| 374920 | COMPOSITE GEAR DIFFERENTIAL COVER - GRAPHITE | 964031 | WASHER S 3.5x10x0.2 (10) |
| 374930 | COMPOSITE GEAR DIFF BEVEL & SATELLITE GEARS (2+4) | 964050 | WASHER S 5x15x0.3 (10) |
| 374970 | ALU GEAR DIFF SHAFT - SWISS 7075 T6 | 951438 | BALL-BEARING 1/4" x 3/8" x 1/8" FLANGED - STEEL SEALED - OIL (2) |
| 374990 | DIFF GASKET (4) | 971255 | SILICONE O-RING 25.5x0.7 (10) |
| 375017-L | X1/X10 REAR GEAR DIFF AXLE SHAFT - LIGHTWEIGHT | 972050 | SILICONE O-RING 5x2 (10) |
| 375037 | ALU GEAR DIFF REAR WHEEL HUB - SWISS 7075 T6 | 980210 | PIN 2x9.8 (10) |
| 375046 | ALU REAR WHEEL HUB - LEFT | | |

3. GEAR DIFFERENTIAL



All ball-bearings are packaged in a separate **BAG 00.9**

Flanged bearing
BEARING OIL (HUDY #106230)
REAR
Flanged bearing
BEARING OIL (HUDY #106230)

These eccentric bushings adjust the **RIDE HEIGHT** of the rear pod. Make sure to use the **SAME** eccentric bushings on **BOTH** sides.

INITIAL SETTING

-1.25 -1.0 -0.75 -0.5 -0.25 0 0.25 0.5 0.75 1.0 1.25



Use tweezers to insert pin.

NOTE Use this satellite gear (from #304930) here.

#304932 GRAPHITE GEAR DIFF BEVEL & SATELLITE GEARS (2+4) OPTION

Use this satellite gear from kit (#374930).

NOTE The cross pins should fit into the differential case smoothly. If not, use a hobby knife to carefully remove any excess material and recheck.



NOTE The cross pins should fit into the differential case smoothly. If not, use a hobby knife to carefully remove any excess material and recheck.

3. GEAR DIFFERENTIAL

Silicone oil
Fill just above the cross-pins.

Fill differential up to the top of the diff cross-pins. DO NOT fill the diff to the top of the housing.

TIP
HUDY Premium Silicone Oil - TRACTION TRACK

LOW		MEDIUM-HIGH		SUPER-HIGH	
500 cSt	#106350	750 cSt	#106375	4000 cSt	#106440
525 cSt	#106352	800 cSt	#106380	5000 cSt	#106450
550 cSt	#106355	900 cSt	#106390	6000 cSt	#106460
575 cSt	#106357	1000 cSt	#106410	7000 cSt	#106470
600 cSt	#106360	2000 cSt	#106420	8000 cSt	#106480
625 cSt	#106362	3000 cSt	#106430	10000 cSt	#106510
650 cSt	#106365				
675 cSt	#106367				
700 cSt	#106370				

NOTE: Softer oil increases steering and traction, harder oil increases stability and cornering speed of the car.

1x 964050
5.5x15x0.3

1x 972050
0.5x2

NOTE ORIENTATION

NOTE
Use this satellite gear (from #374930) here.

CUTAWAY VIEW

1x 971255
0.25x0.7

!
After disassembling the gear diff the large O-ring may have an increased size and may be more difficult to re-install. We recommend either inserting the old O-ring carefully in the diff cover, or replacing the old O-ring with a new O-ring if the old one cannot be made to fit properly.

4x 903258
SFH M2.5x8

!
Tighten the screws equally but DO NOT tighten them completely.

Finish tightening in this order.

3. GEAR DIFFERENTIAL

1x 908258
SCH M2.5x8

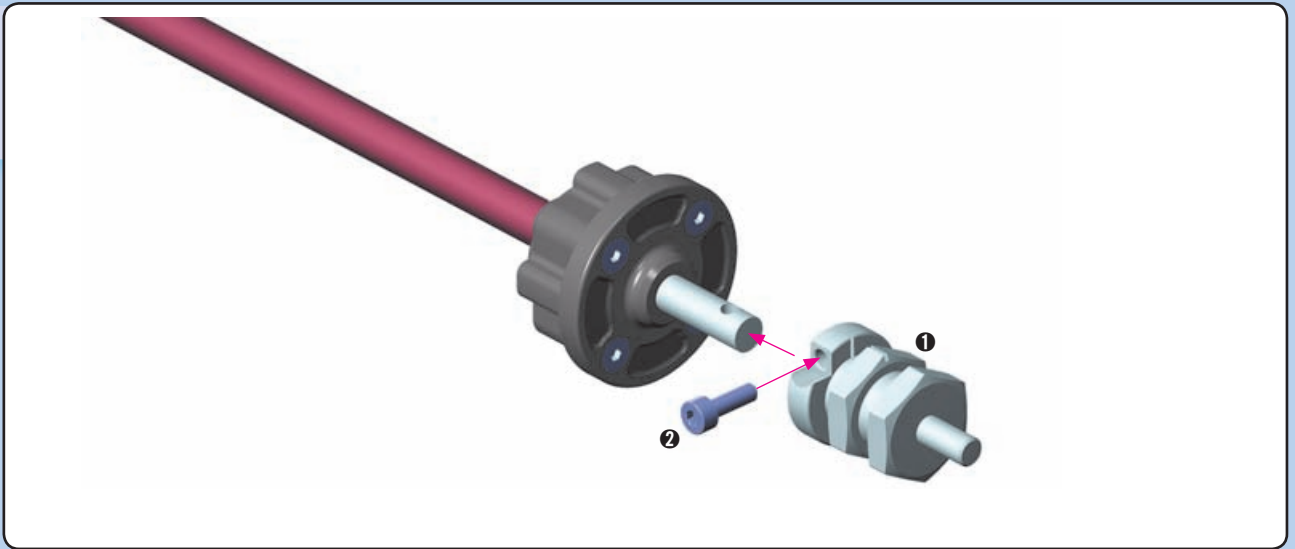

4x 902256
SH M2.5x6

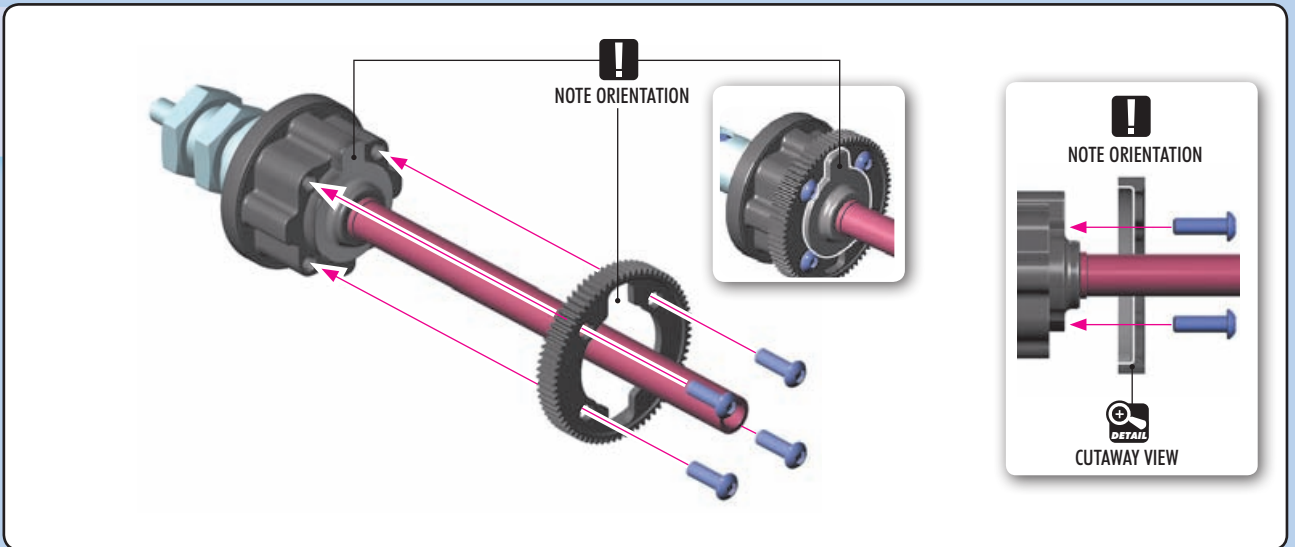

2x 375090
6.4x8.4x2.0

1x 908258
SCH M2.5x8

Optional
2x 375090
6.4x8.4x1.0

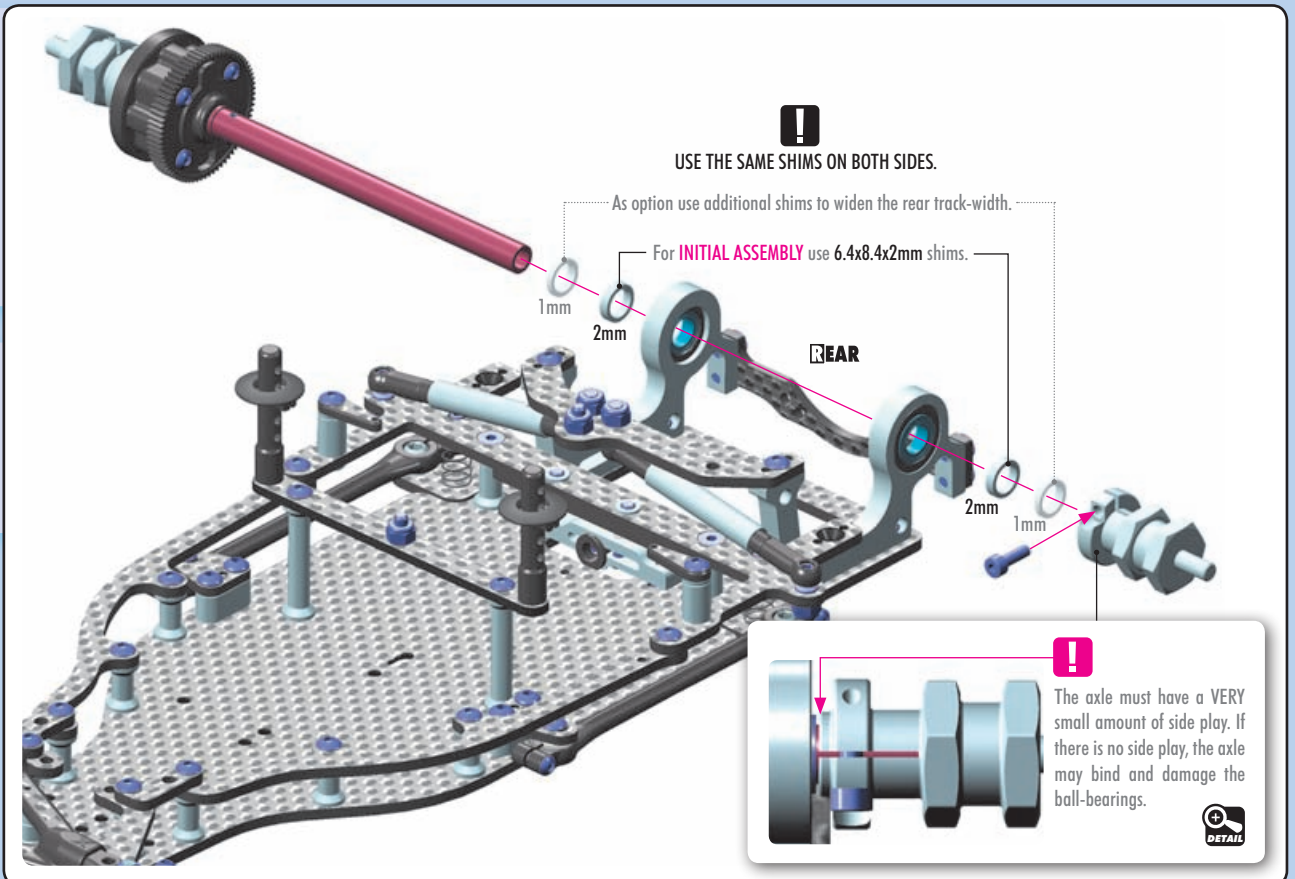

4. CENTER SHOCK



#104002
HUDY AIR VAC – VACUUM PUMP - ON-ROAD



XRAY SPRINGS

#308263	C = 2.3-2.6 (2)	INCLUDED
#308264	C = 2.5-2.8 (2)	OPTION
#308274	C = 2.3 (2)	OPTION
#308275	C = 2.5 (2)	OPTION
#308286	C = 2.6 (2)	OPTION
#308276	C = 2.7 (2)	OPTION
#308277	C = 2.9 (2)	OPTION
#308290	C = 3.0 (2)	OPTION

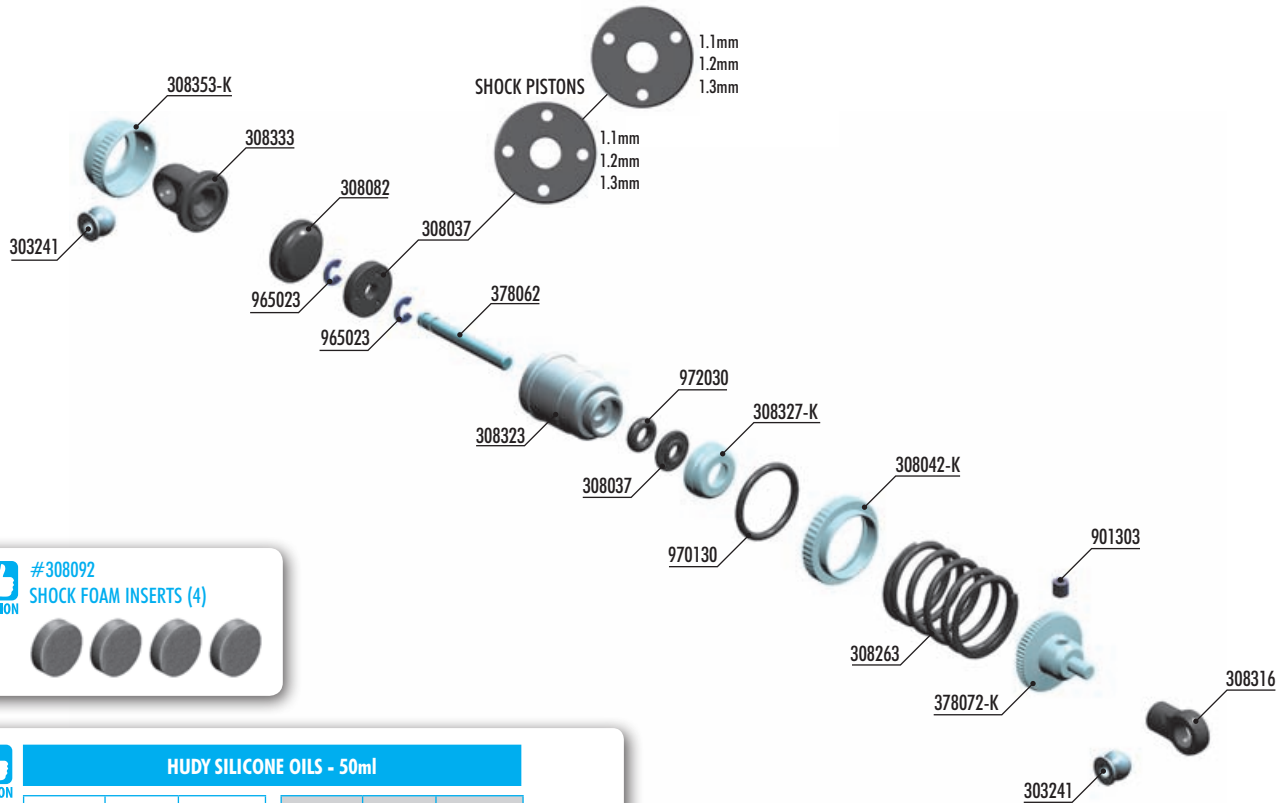

#308092
SHOCK FOAM INSERTS (4)



HUDY SILICONE OILS - 50ml

#	Viscosity	Status	#	Viscosity	Status
#106330	300cSt	OPTION	#106360	600cSt	INCLUDED
#106335	350cSt	OPTION	#106362	625cSt	OPTION
#106337	375cSt	OPTION	#106365	650cSt	OPTION
#106340	400cSt	OPTION	#106367	675cSt	OPTION
#106342	425cSt	OPTION	#106370	700cSt	OPTION
#106345	450cSt	OPTION	#106375	750cSt	OPTION
#106347	475cSt	OPTION	#106380	800cSt	OPTION
#106350	500cSt	OPTION	#106390	900cSt	OPTION
#106352	525cSt	OPTION	#106410	1000cSt	OPTION
#106355	550cSt	OPTION	#106420	2000cSt	OPTION
#106357	575cSt	OPTION			



#308039
ALU PROGRESSIVE SHOCK SYSTEM - SET (2)

Progressive shock system for improved traction and steering characteristics. Shock insert has 3 triangle cuts and is used with piston WITHOUT holes. The hardness of the shock is influenced not by the holes in the piston, but rather by the insert.



BAG

04

- 303241 BALL UNIVERSAL 5.8mm HEX (4)
- 308037 COMPOSITE PISTONS 4-HOLE 1.0-1.2mm, 3-HOLE 1.0-1.2mm
- 308042-K ALU SHOCK ADJUSTABLE NUT - BLACK (2)
- 308082 SHOCK ABSORBER MEMBRANE (4)
- 308316 SHOCK BALL JOINT - OPEN (4)
- 308323 ALU XRAY SHOCK BODY (2)
- 308327-K ALU CAP FOR XRAY SHOCK BODY - BLACK
- 308333 COMPOSITE SHOCK PARTS FOR ALU SHOCKS
- 308353-K ALU SHOCK CAP-NUT WITH VENT HOLE - BLACK (2)
- 308263 XRAY 4S SPRING-SET PROGRESSIVE C=2.3-2.6 (2)
- 378062 SHOCK SHAFT

- 378072-K ALU SHOCK SPRING COLLAR - BLACK
- 901303 HEX SCREW SB M3x3 (10)
- 965023 E-CLIP 2.3 (10)
- 970130 O-RING 13 x 1.5 (10)
- 972030 SILICONE O-RING 3 x 2 (10)

Numbers in parentheses () refer to quantities when purchased separately.

4. CENTER SHOCK

2x 965023
C.2.3

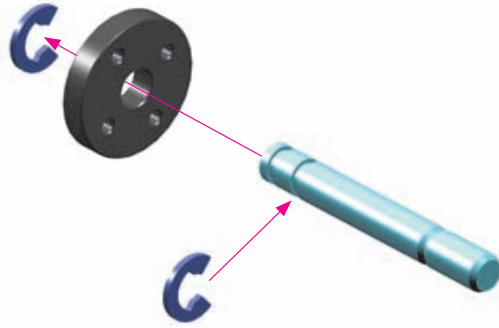

SHOCK PISTON ADJUSTMENT

3 HOLES



4 HOLES

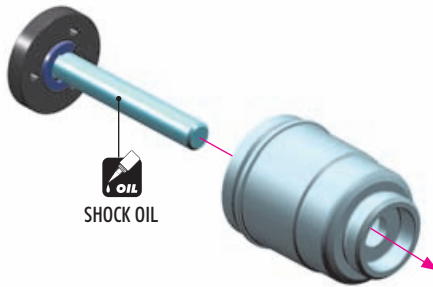

1x 972030
0.3x2

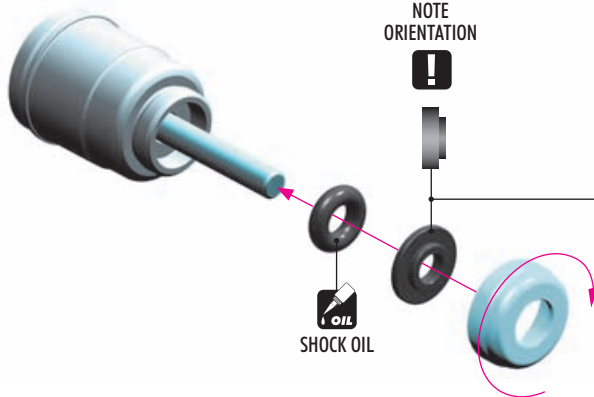

DETAIL

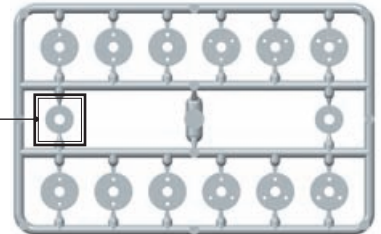

1x 970130
0.13x1.5

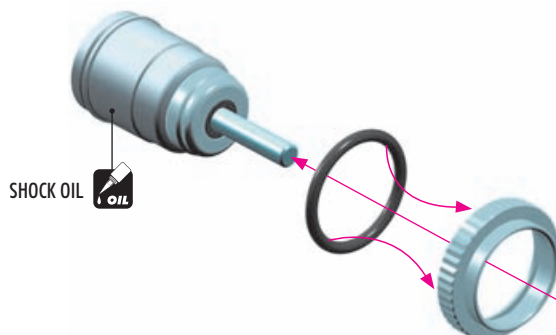

DETAIL

CUTAWAY VIEW



! Be careful not to cross-thread the collar on the shock body.

4. CENTER SHOCK

SHOCK FILLING

SOFTER OIL

Recommended for bumpy and low-traction tracks, generates more traction.

HARDER OIL

Recommend for flat and high-traction tracks, improves steering response.

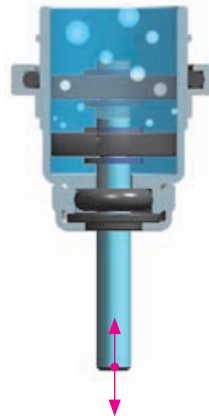

- 1 Fully extend the piston rod so the piston is at the bottom of the shock body.
- 2 Hold the shock upright and slightly overfill the shock body with shock oil.
- 3 Let the oil settle and allow air bubbles to rise to the top. Slowly move the piston up and down to allow oil into all cavities within the shock body.
- 4 Extend the piston rod most of the way out of the shock body. Let the shock rest for 5 minutes to allow the air bubbles to escape.
- 5 Add shock oil as necessary.

#104002
HUDY AIR VAC – VACUUM PUMP



TIP

To make sure that all the air is removed from the shock oil, we recommend using the HUDY Air Vac.



HUDY SILICONE OILS - 50ml

#106330	300cSt	OPTION
#106335	350cSt	OPTION
#106337	375cSt	OPTION
#106340	400cSt	OPTION
#106342	425cSt	OPTION
#106345	450cSt	OPTION
#106347	475cSt	OPTION
#106350	500cSt	OPTION
#106352	525cSt	OPTION
#106355	550cSt	OPTION
#106357	575cSt	OPTION
#106360	600cSt	INCLUDED
#106362	625cSt	OPTION
#106365	650cSt	OPTION
#106367	675cSt	OPTION
#106370	700cSt	OPTION
#106375	750cSt	OPTION
#106380	800cSt	OPTION
#106390	900cSt	OPTION
#106410	1000cSt	OPTION
#106420	2000cSt	OPTION

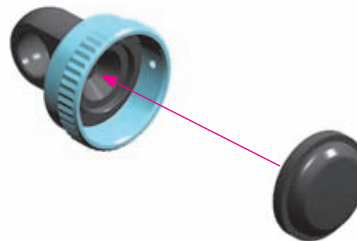

CUTAWAY VIEW



After you insert the membrane, ensure that it is fully seated inside the alu cap.

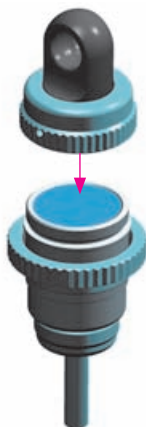

- 1 When installing the shock cap assembly on the shock body, some oil will leak out... this is normal.
- 2 Tighten the cap and clean off any excess oil.
- 3 After the shock is assembled, the shock rod will push itself out of the shock body fairly quickly.
- 4 Follow the next procedure to adjust the rebound.

4. CENTER SHOCK

REBOUND ADJUSTMENT

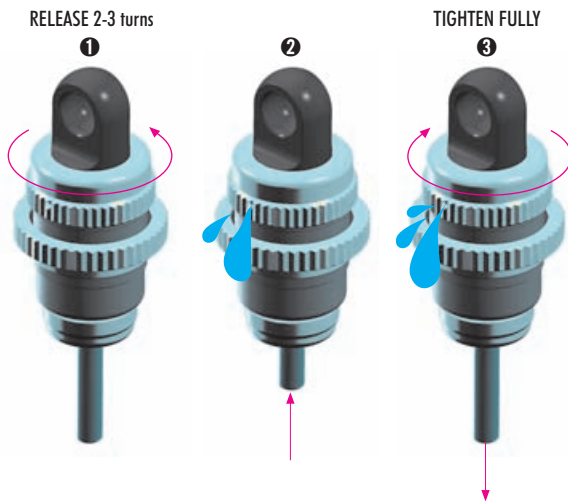

AFTER THE SHOCK IS ASSEMBLED YOU HAVE TO SET THE SHOCK REBOUND:

- 1 Release the shock cap by 2-3 turns.
- 2 Push the shock shaft fully up. For the first time the extra oil will release through the hole in the alu cap-nut.
- 3 Tighten the shock cap. When tightening the shock cap, extra oil will again release through the hole in the alu cap - nut. When tightening, the shock shaft will push out from the shock body.

REBOUND CHECK

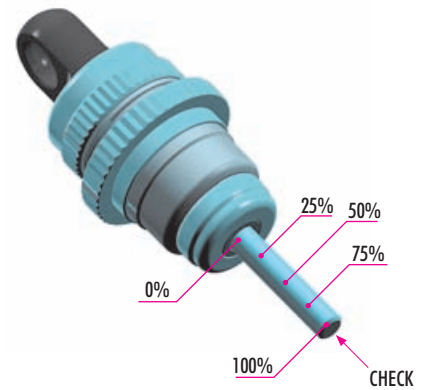

REBOUND CHECK:

It is very important to push the shock shaft into the shock body slowly otherwise air can come into the shock body which would create bubbles.

- 100% rebound - DO NOT do step 2 and 3
- 75% rebound - repeat steps 1 to 3 until the shock shaft will push out 75% of its length
- 50% rebound - repeat steps 1 to 3 until the shock shaft will push out 50% of its length
- 25% rebound - repeat steps 1 to 3 until the shock shaft will push out 25% of its length
- 0% rebound - repeat steps 1 to 3 until the shock shaft will push out 0% of its length

If the shock shaft does not rebound enough, you will have to refill the shock with shock oil, and then repeat the bleeding and rebound adjustment procedure.

1x 901303
SB M3x3

! An innovative new feature is to change the center shock length (and front mounting position). By using longer or shorter shock, the damping and steering can be changed.

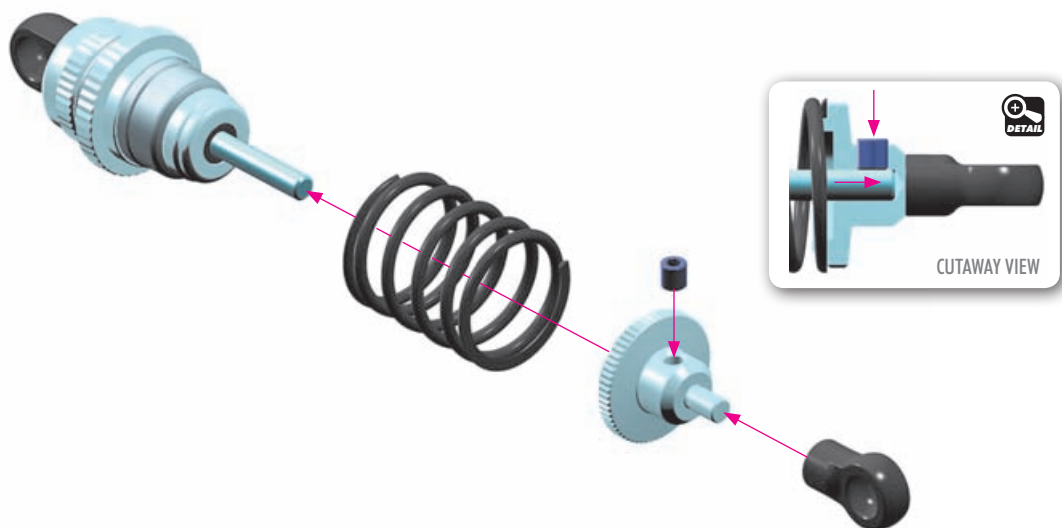

4. CENTER SHOCK

NOTE ORIENTATION
(Shiny finish side) 

TIP Install the balls with
Professional Multi-Tool (HUDY #183011)



 NOTE ORIENTATION
(Shiny finish side)

NOTE ORIENTATION 

REAR

DOWNSTOP ADJUSTMENT

The length of the shock absorber affects the amount of rear downstop.
To adjust, thread the ball-joint on or off the bottom spring cap.

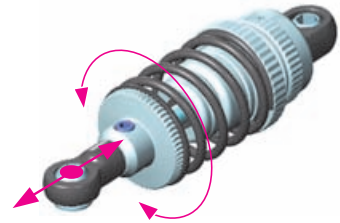

TIP Jan Ratheisky (Factory Driver)

Set the ride height for your track and measure it at the link connection of the side pod. Lift the car on the rear part of the center shock. When you unload the shock fully, you can measure the height at the same spot again. The difference to the ride height is the droop amount. The set-up of the rear downstop is very important to find a good balance between traction and rotation. On both indoor and outdoor tracks, I recommend starting with 1mm droop. Less droop gives you more rear traction. Recommended for low-traction conditions. More droop frees up the rear and makes it looser, but results in more steering. You should not use more than 2.5mm rear droop at maximum.

 **DETAIL**

65mm

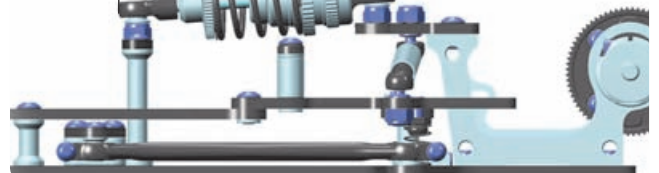

5. FINAL ASSEMBLY

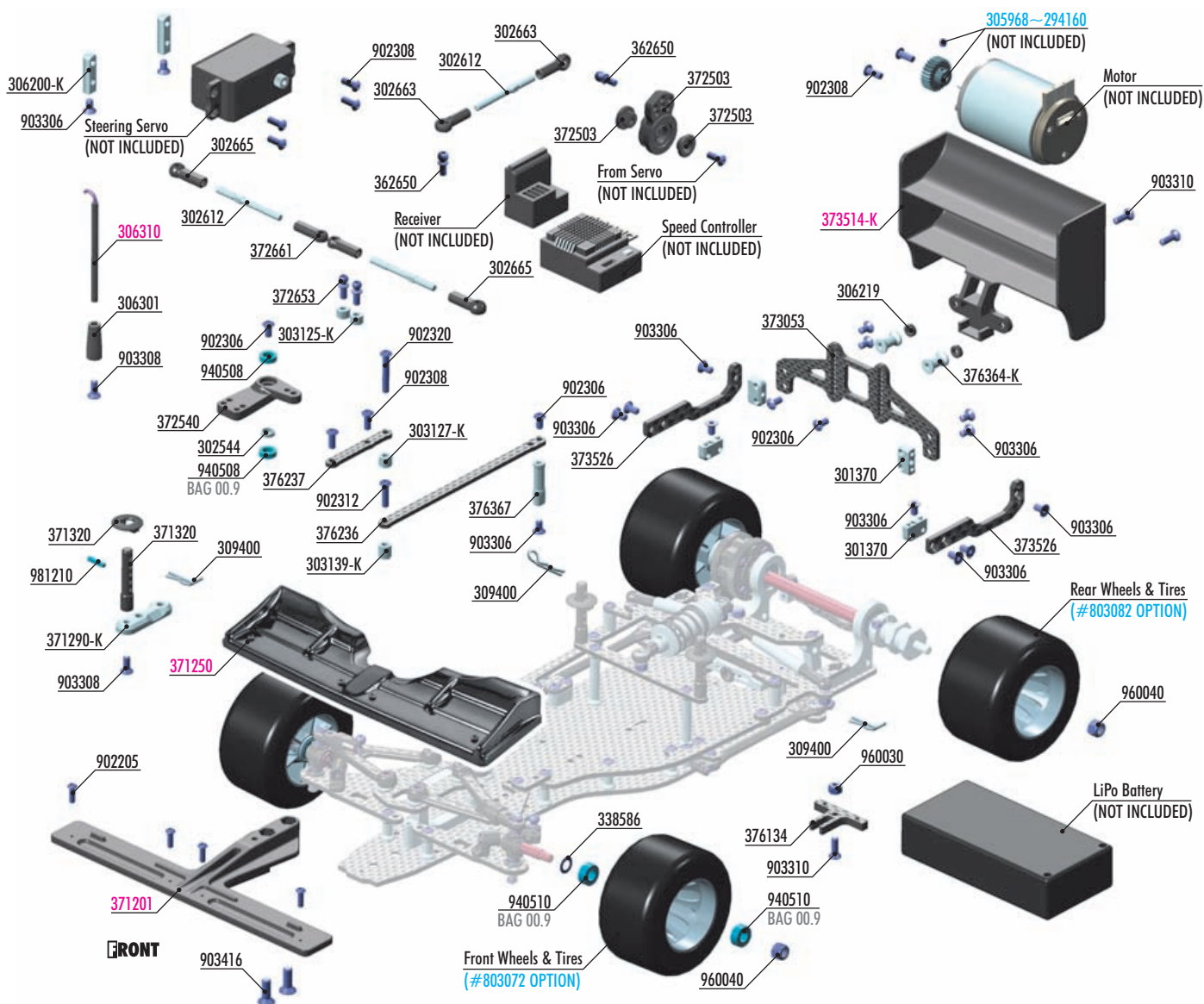

- # 305968~294160 PINION GEAR HARDCOATED 18~60T/64P
- #372541-K ALU ADJUSTABLE SERVO SAVER SET - BLACK
- #371202 X1 COMPOSITE ADJUSTABLE FRONT AERO WING - ETS APPROVED
- #371203-K X1 COMPOSITE ADJUSTABLE FRONT WING - BLACK - ETS APPROVED
- #371203 X1 COMPOSITE ADJUSTABLE FRONT WING - WHITE - ETS APPROVED
- #371204-K X1 COMPOSITE ADJUSTABLE FRONT WING - BLACK - FLAT DESIGN
- #371204 X1 COMPOSITE ADJUSTABLE FRONT WING - WHITE - FLAT DESIGN

- #373513-K
- #373514
- #379701
- #379702
- #803072
- #803082

- X1 COMPOSITE ADJUSTABLE REAR WING - BLACK - ETS APPROVED
- X1 COMPOSITE REAR WING - LIGHTWEIGHT & WIDE - WHITE
- XRAY X1 1/10 FORMULA BODY
- XRAY X1 1/10 FORMULA BODY - WORLD CHAMPION EDITION
- HUDDY 1/10 FORMULA RUBBER TIRE - FRONT (2)
- HUDDY 1/10 FORMULA RUBBER TIRE - REAR (2)



- | | | | |
|----------|---|----------|---|
| 301370 | ALU PLATE FOR REAR GRAPHITE BODY POST HOLDER | 376237 | GRAPHITE TOP DECK 2.2mm - SHORT |
| 302544 | ALU SHIM FOR RADIAL PLAY ADJUSTMENT OF STEERING ARM (2) | 376364-K | ALU MOUNT 10.8mm - BLACK (2) |
| 302612 | ALU ADJ. TURNBUCKLE M3 L/R 39mm - SWISS 7075 T6 (2) | 376367 | ALU MOUNT 22.5mm - BLACK |
| 302663 | COMPOSITE BALL JOINT 4.9mm - OPEN - V2 (8) | 338586 | SHIM 5x7x0.5 (10) |
| 302665 | COMPOSITE BALL JOINT 4.9mm - CLOSED WITH HOLE (4) | 902205 | HEX SCREW SH M2x5 (10) |
| 303125-K | ALU SHIM 3x6x3.0mm (10) | 902306 | HEX SCREW SH M3x6 (10) |
| 303127-K | ALU SHIM 3x6x4.0mm (10) | 902308 | HEX SCREW SH M3x8 (10) |
| 303139-K | ALU SHIM 3x6x7.0mm (10) | 902312 | HEX SCREW SH M3x12 (10) |
| 306200-K | ALU SERVO MOUNT - BLACK (2) | 902320 | HEX SCREW SH M3x20 (10) |
| 306219 | COMPOSITE SET OF SERVO SHIMS (4) | 903306 | HEX SCREW SFH M3x6 (10) |
| 306301 | ANTENNA MOUNT - THIN | 903308 | HEX SCREW SFH M3x8 (10) |
| 309400 | BODY CLIP (8) | 903310 | HEX SCREW SFH M3x10 (10) |
| 362650 | BALL END 4.9mm WITH THREAD 6mm (2) | 903416 | HEX SCREW SFH M4x16 (10) |
| 371290-K | ALU BODY POST PLATE - BLACK | 940508 | BALL-BEARING 5x8x2.5 RUBBER SEALED - OIL (2) |
| 371320 | COMPOSITE BODY POST (2) | 940510 | BALL-BEARING 5x10x4 RUBBER SEALED - OIL (2) |
| 372503 | COMPOSITE SERVO SAVER - X-STIFF - SET - V2 | 960030 | NUT M3 (10) |
| 372540 | COMPOSITE STEERING ARM | 960040 | NUT M4 (10) |
| 372653 | BALL END 4.2MM WITH 8mm THREAD (2) | 981210 | PIN 2x10 (10) |
| 372661 | COMPOSITE STEERING BALL JOINT OPEN 4.2 MM (4) | 306310 | ANTENNA (2) |
| 373053 | GRAPHITE REAR WING MOUNT 2.5mm | 371201 | X1 COMPOSITE FRONT BUMPER |
| 373526 | GRAPHITE REAR WING HOLDER PLATE 2.5mm (L+R) | 371250 | X1 LEXAN FRONT SPOILER (2) |
| 376134 | GRAPHITE BATTERY BACKSTOP - MIDDLE | 373514-K | X1 COMPOSITE REAR WING - LIGHTWEIGHT & WIDE - BLACK |
| 376236 | GRAPHITE TOP DECK 2.2mm - LONG | | |

Numbers in parentheses () refer to quantities when purchased separately.

5. FINAL ASSEMBLY

2x STEERING LINKS

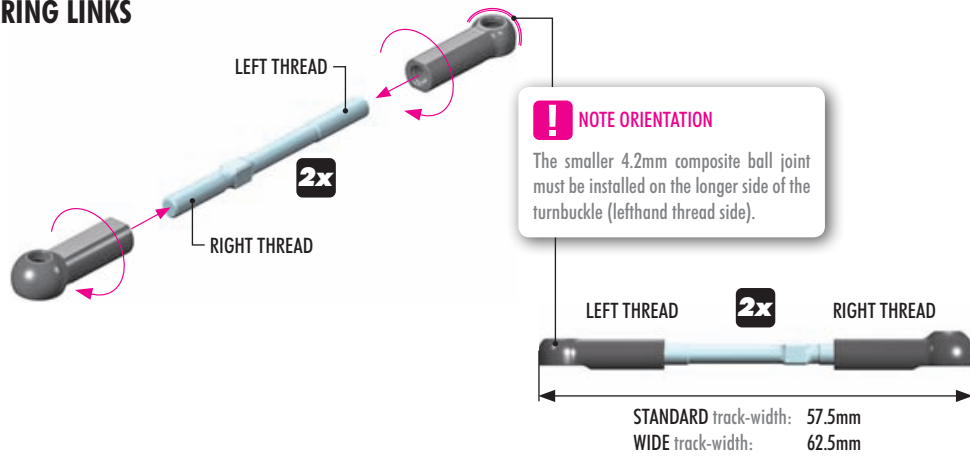

2x 303125-K SHIM 3x6x3

These shims adjust the bumpsteer.

When thicker shims are used here, in-corner steering increases, but the car becomes more difficult to drive.

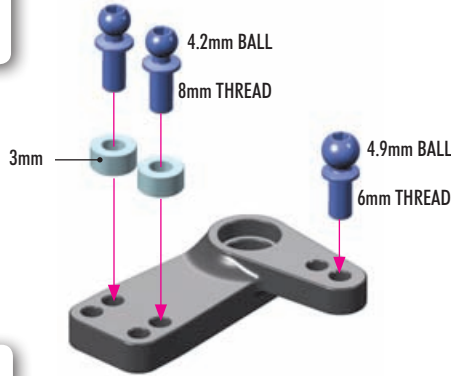

#372541-K ALU ADJUSTABLE SERVO SAVER SET OPTION



The steering arm has two positions for servo linkage mounting.

Always use this position ← INITIAL SETTING



There are two Ackermann positions on the steering arm.

INNER position: More Ackermann, makes the car easier to drive, improves cornering speed (INITIAL SETTING).

OUTER position: Less Ackermann, makes the car more responsive, improves in-corner steering.

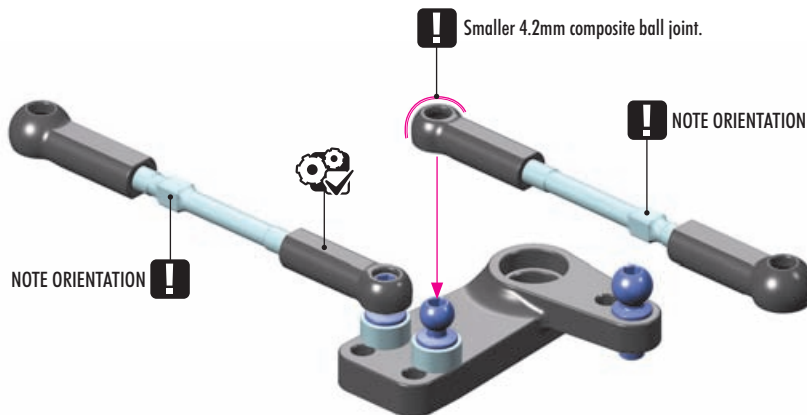

5. FINAL ASSEMBLY



4x 902308
SH M3x8

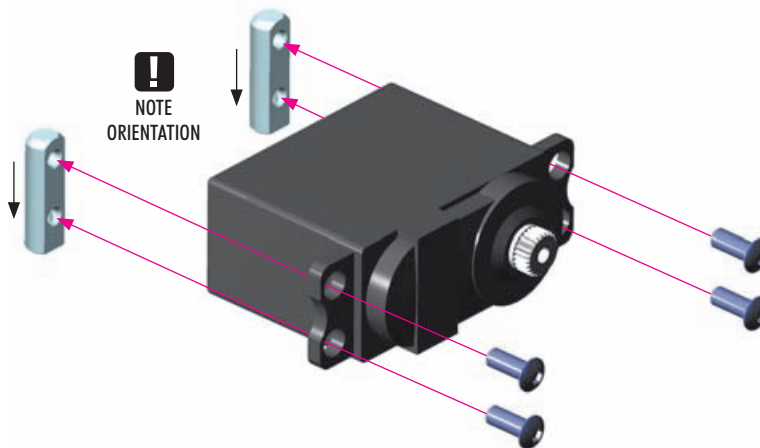

SERVO SAVER

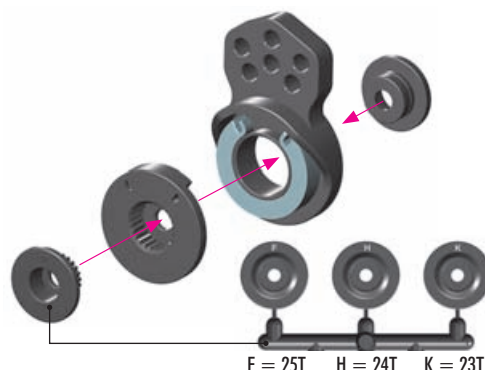
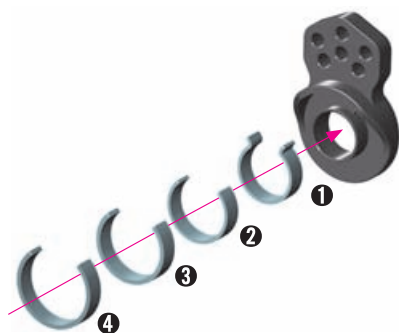

F = 25T H = 24T K = 23T
! Use the adapter that matches the steering servo.

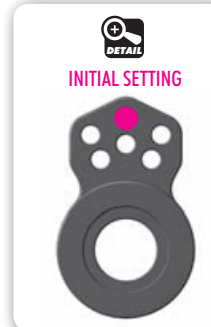
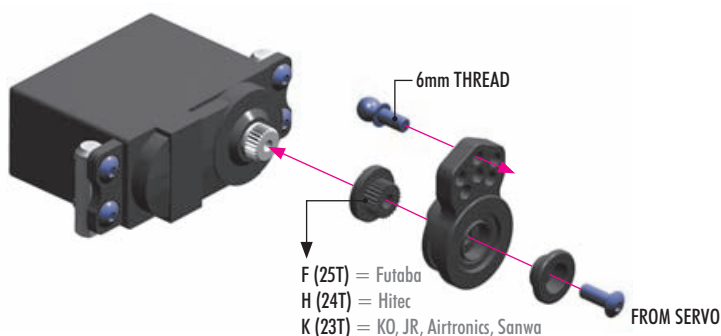

For more in-corner steering and better steering response, aluminum servo horns may be used.

OPTION	ALU SERVO HORNS - OFFSET
#293491	KO, Sanwa - 23T
#293492	Hitec - 24T
#293493	Futaba - 25T
OPTION	CLAMP ALU SERVO HORNS - OFFSET
#293401	KO, Sanwa - 23T
#293402	Hitec - 24T
#293403	Futaba - 25T

OPTION	HUDY ALU SERVO HORNS
#293497	KO, Sanwa - 23T
#293498	Hitec - 24T
#293499	Futaba - 25T
OPTION	HUDY CLAMP ALU SERVO HORNS
#293404	KO, Sanwa - 23T
#293405	Hitec - 24T
#293406	Futaba - 25T

OPTION	HUDY ALU SERVO HORNS
#293501	KO, Sanwa - 23T
#293502	Hitec - 24T
#293503	Futaba - 25T
OPTION	HUDY CLAMP ALU SERVO HORNS
#293407	KO, Sanwa - 23T
#293408	Hitec - 24T
#293409	Futaba - 25T

! **IMPORTANT!**
When an aluminum horn is used, the steering servo saver is not used. This increases the risk of breaking the servo in serious crashes.

5. FINAL ASSEMBLY



3x 903306
SFH M3x6

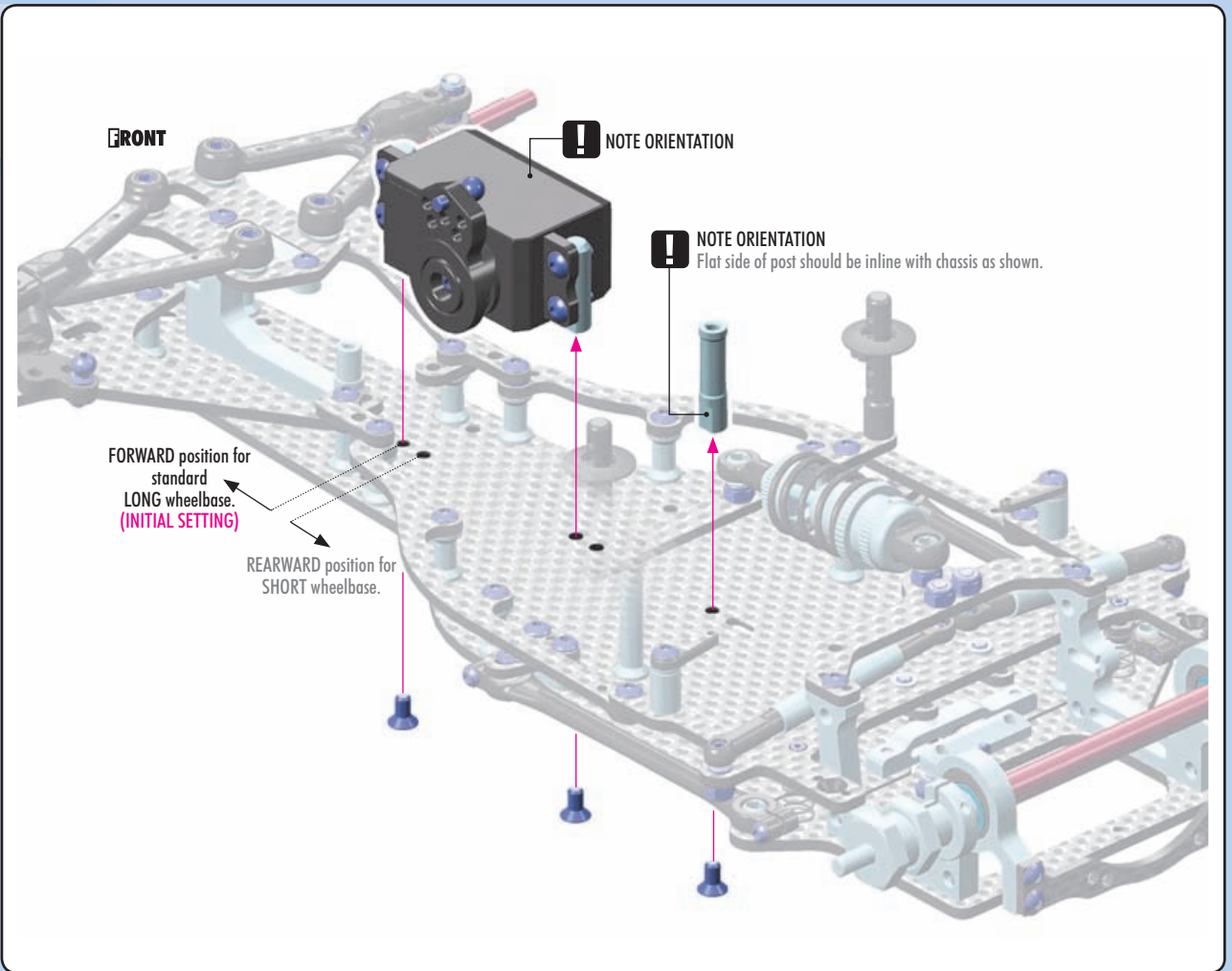

2x 940508
BB 5x8x2.5

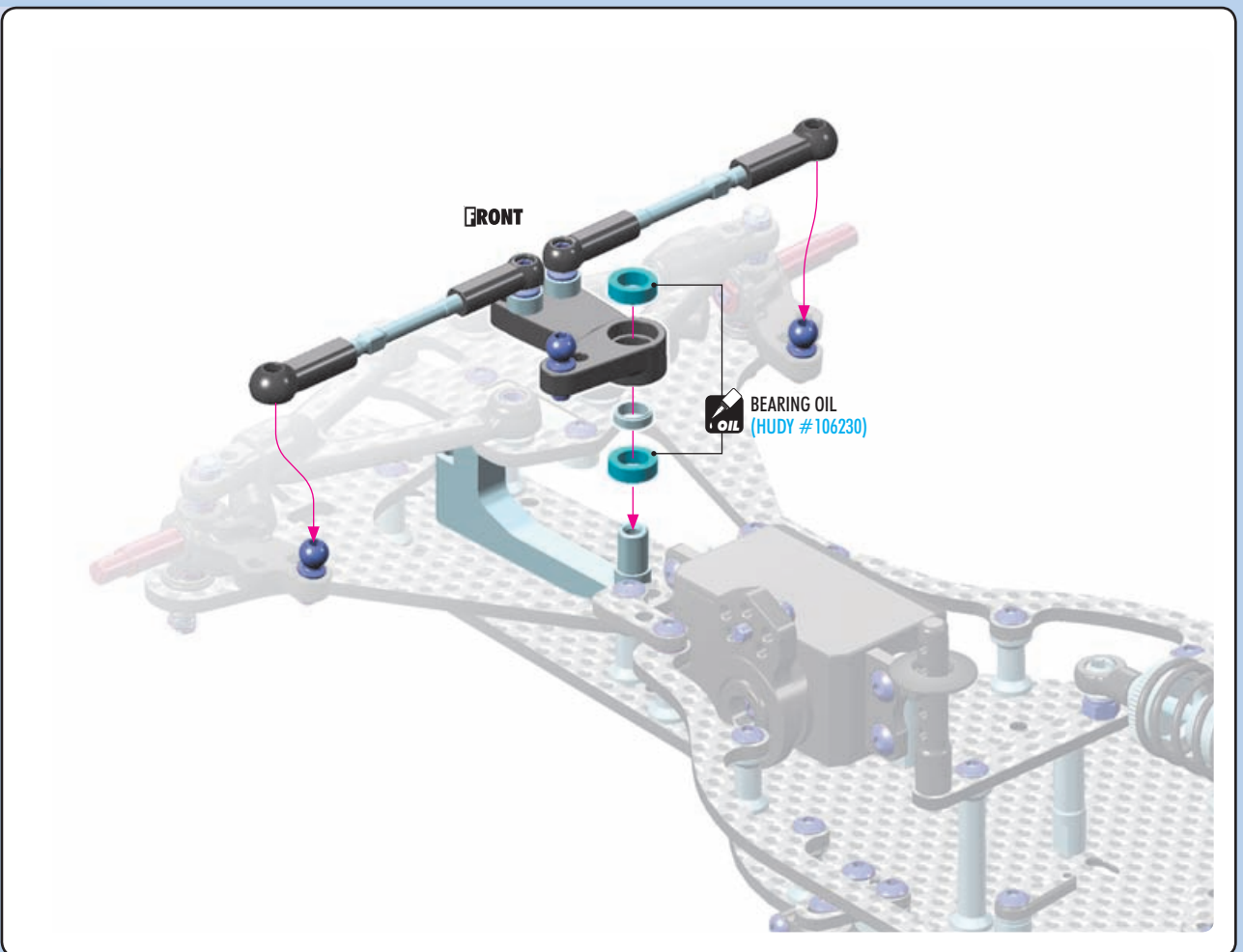

5. FINAL ASSEMBLY

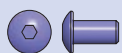

1x 902306
SH M3x6

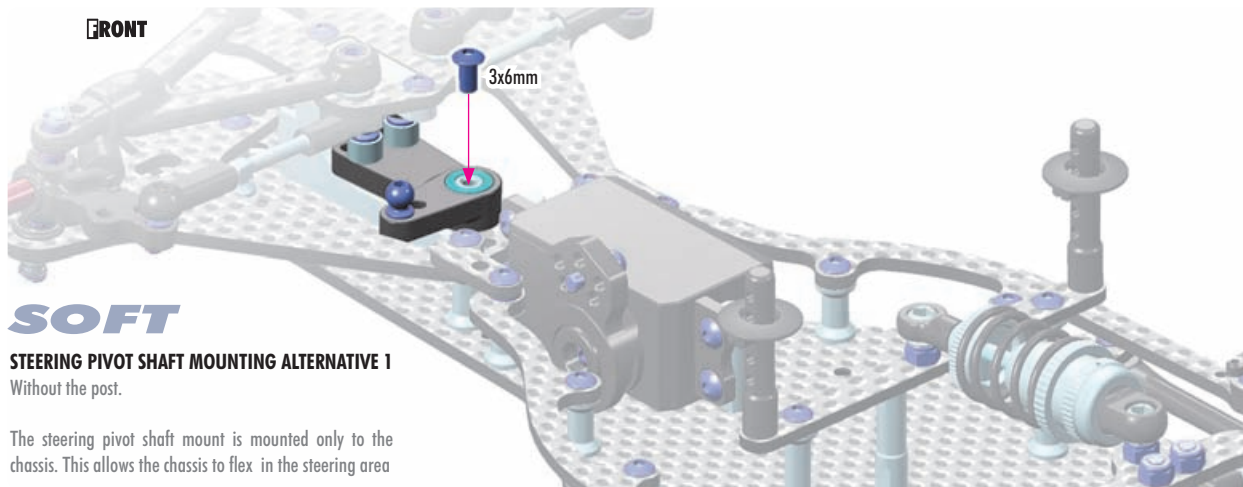

SOFT

STEERING PIVOT SHAFT MOUNTING ALTERNATIVE 1

Without the post.

The steering pivot shaft mount is mounted only to the chassis. This allows the chassis to flex in the steering area



1x 303139-K
SHIM 3x6x7

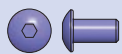

1x 902306
SH M3x6



1x 902312
SH M3x12

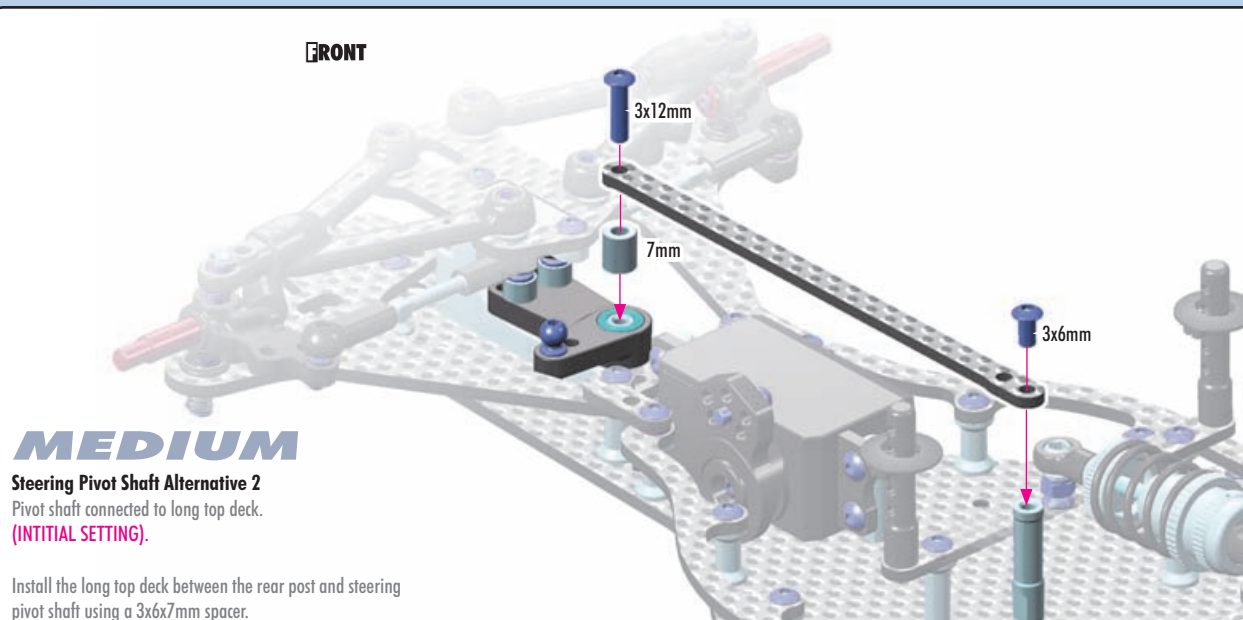

MEDIUM

Steering Pivot Shaft Alternative 2

Pivot shaft connected to long top deck.

(INITIAL SETTING).

Install the long top deck between the rear post and steering pivot shaft using a 3x6x7mm spacer.



1x 303127-K
SHIM 3x6x4



1x 303139-K
SHIM 3x6x7

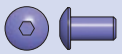

1x 902306
SH M3x6

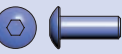

2x 902308
SH M3x8



1x 902320
SH M3x20

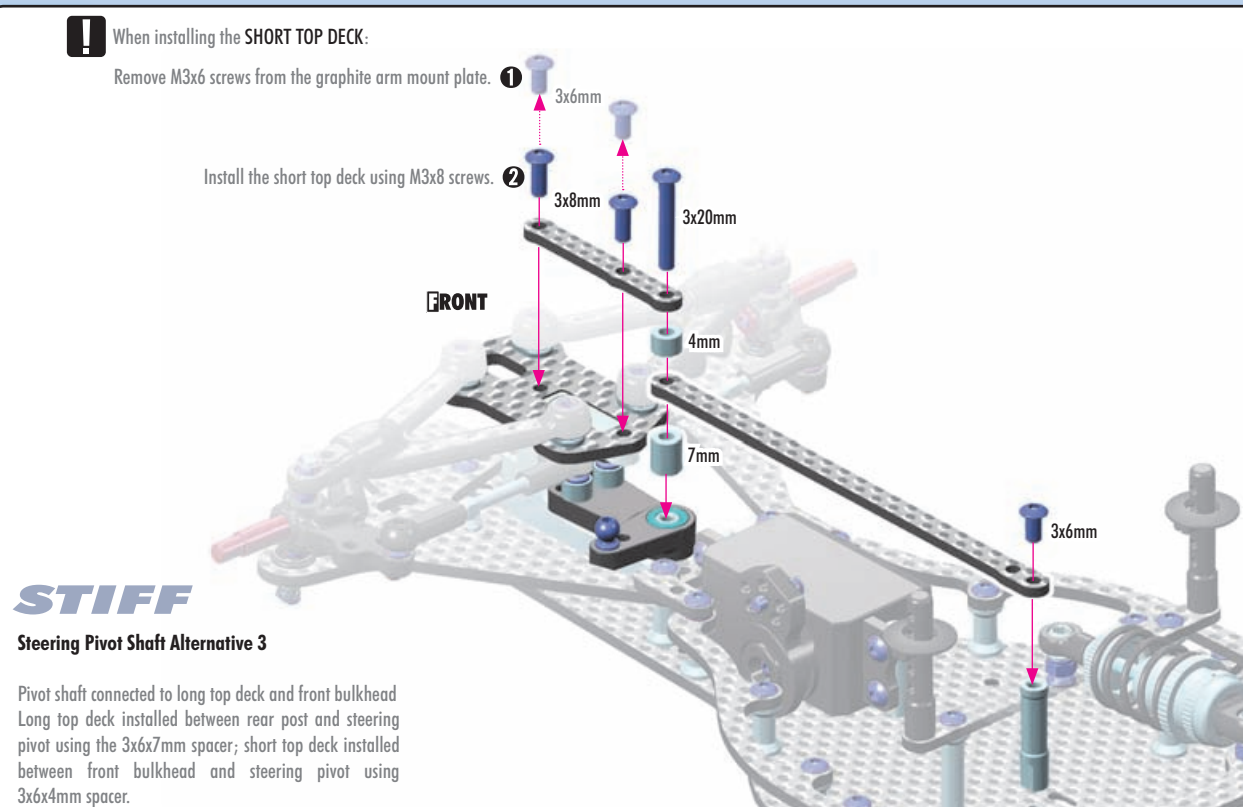

STIFF

Steering Pivot Shaft Alternative 3

Pivot shaft connected to long top deck and front bulkhead
Long top deck installed between rear post and steering pivot using the 3x6x7mm spacer; short top deck installed between front bulkhead and steering pivot using 3x6x4mm spacer.

5. FINAL ASSEMBLY



6x 903306
SFH M3x6

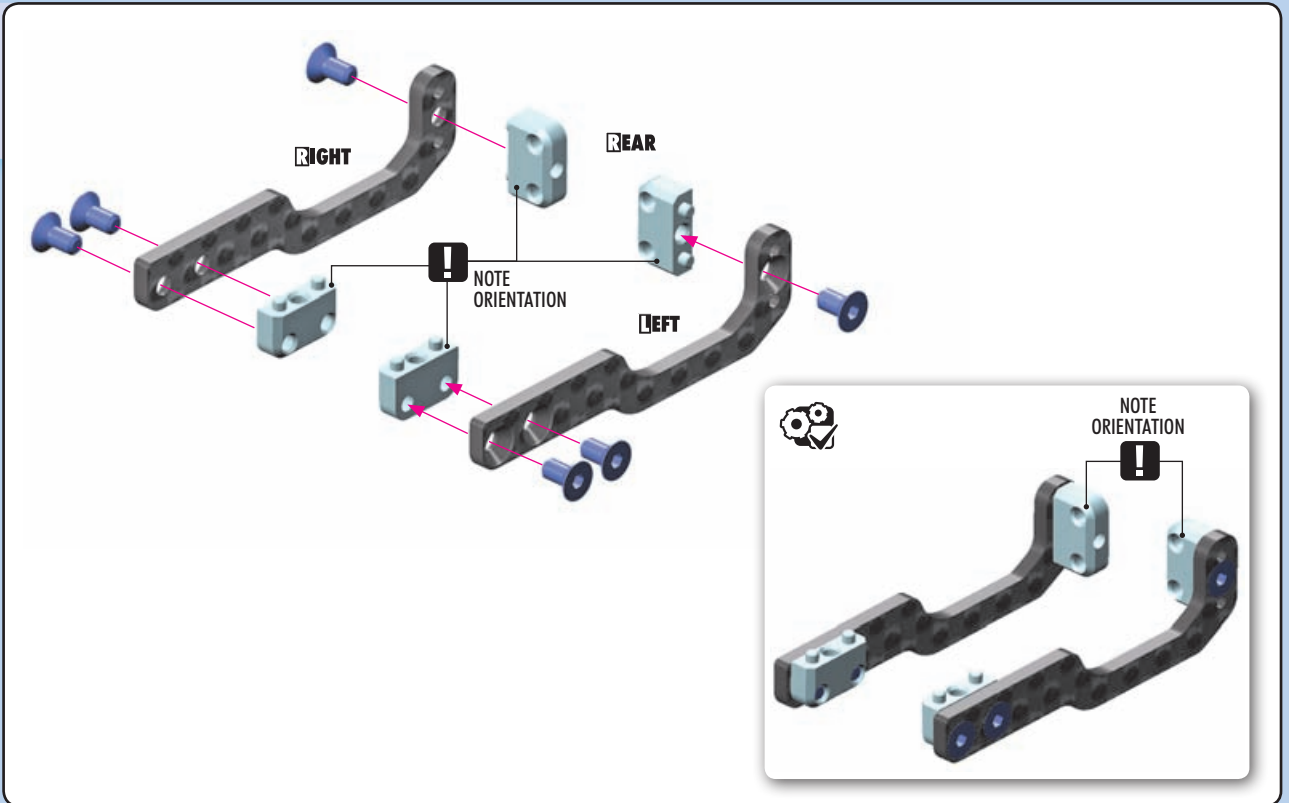

SERVO LINK

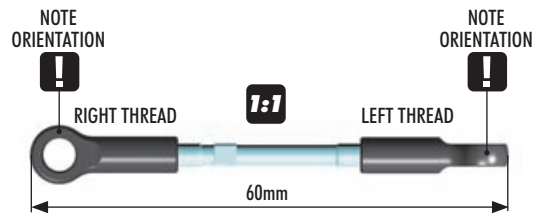
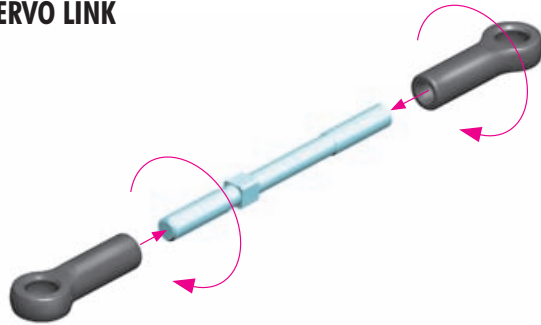

The length of the link depends on the wheelbase setting. The 63mm length is recommended for standard wheelbase setting.
(INITIAL SETTING)

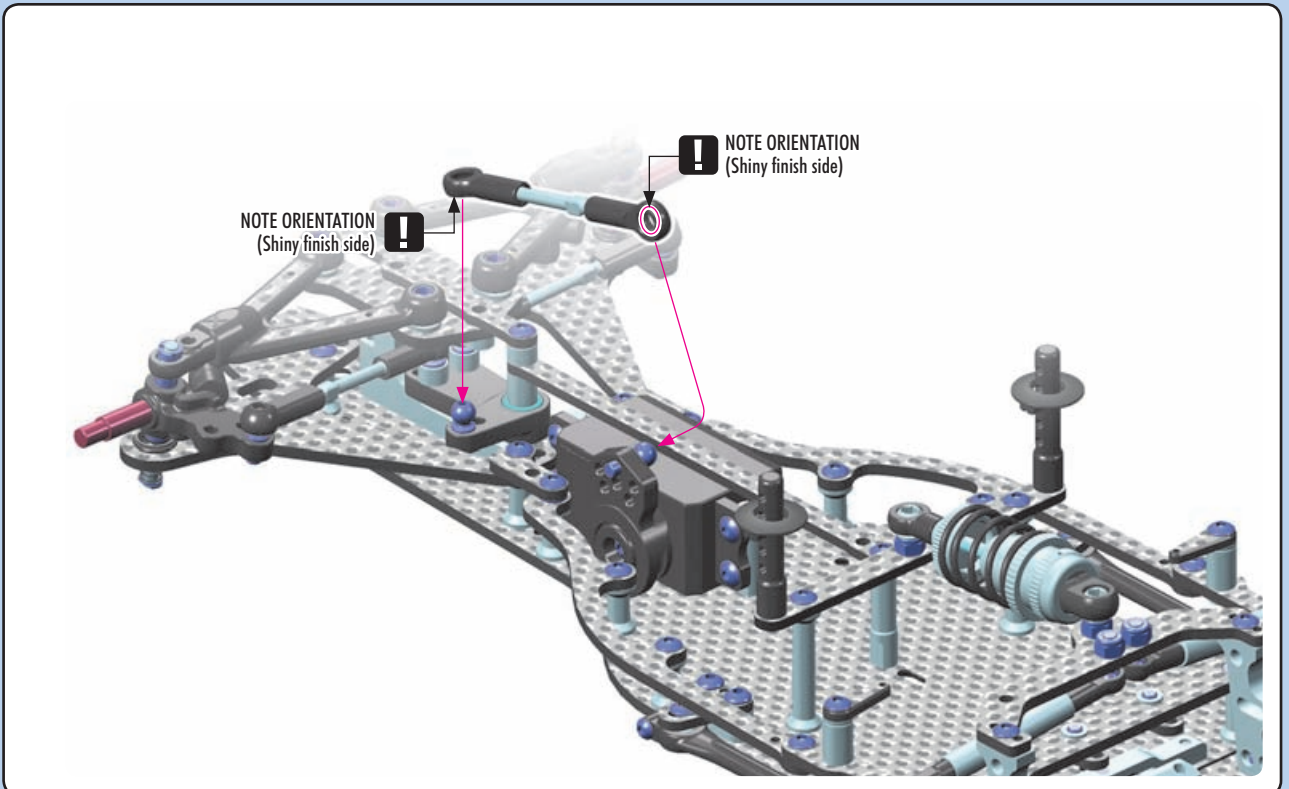

5. FINAL ASSEMBLY



2x 902306
SH M3x6



4x 903306
SFH M3x6

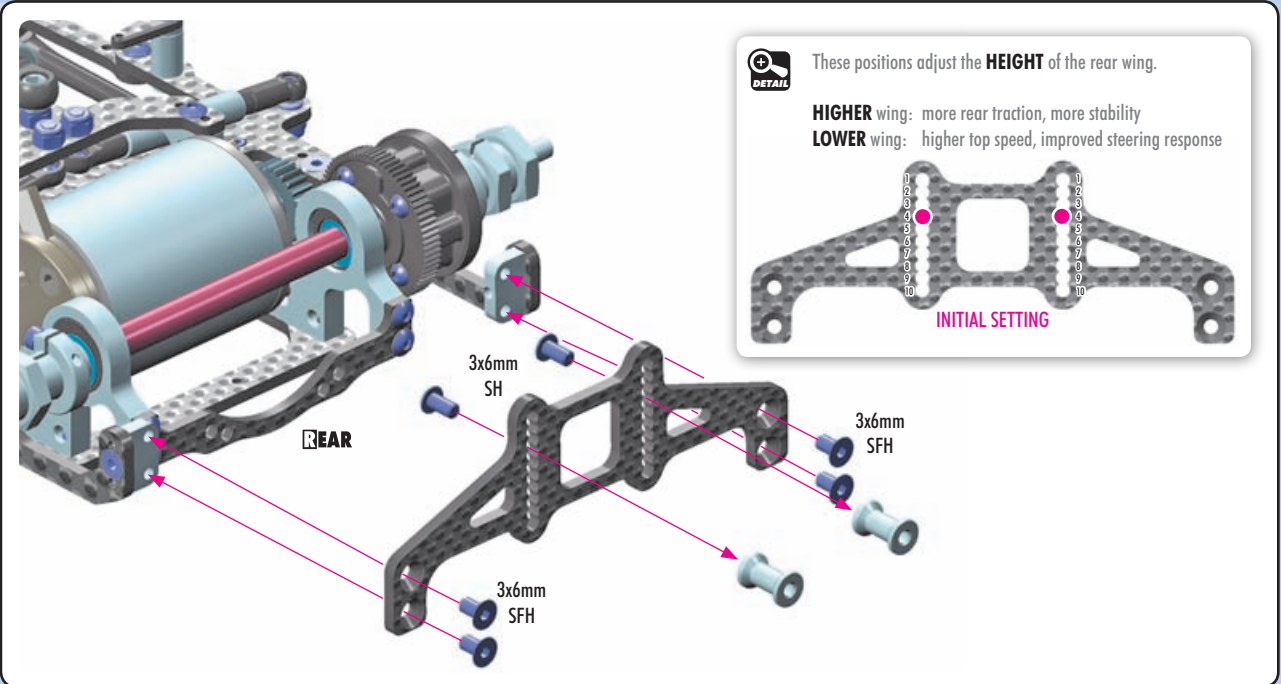

2x 903306
SFH M3x6

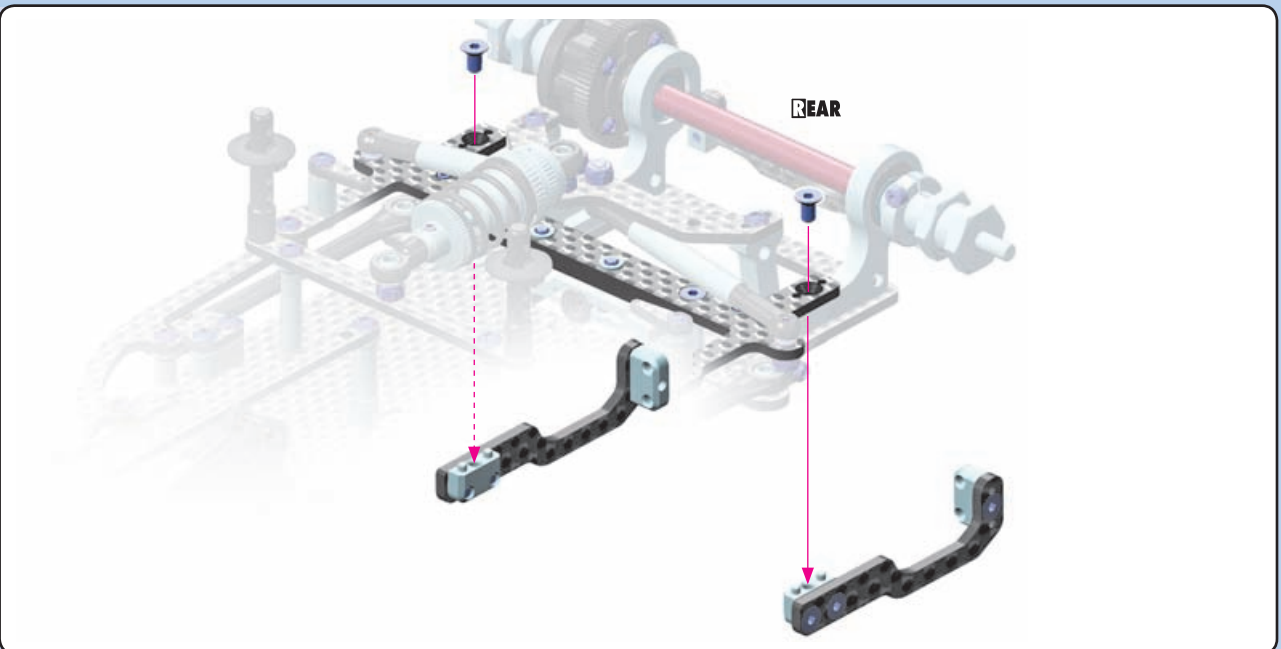

2x 306219
SHIM 3x6x2



2x 903310
SFH M3x10

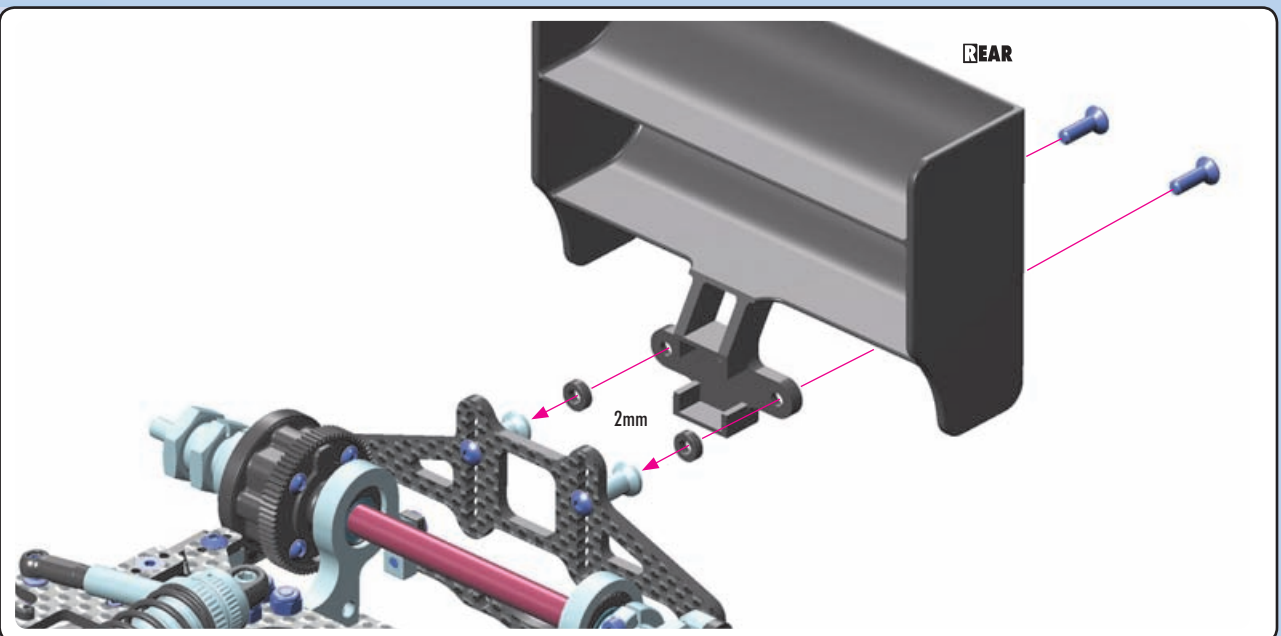

5. FINAL ASSEMBLY



#373513-K
OPTION X1 COMPOSITE ADJUSTABLE REAR WING - BLACK - ETS APPROVED

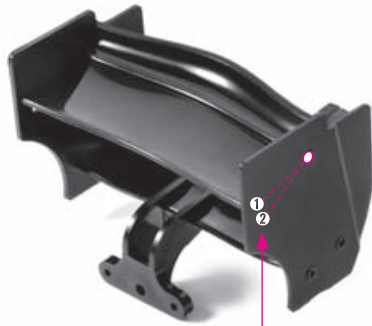

WING POSITION

1 LOW DOWNFORCE:

Low downforce setting is recommended on tracks where top speed is more important over rear stability on-power/in high speed corners.

2 HIGH DOWNFORCE:

High downforce setting recommended for most tracks.

#373514
OPTION X1 COMPOSITE REAR WING - LIGHTWEIGHT & WIDE - WHITE



ALU PINION GEARS HARDCOATED - 64P

#305968	18T	OPTION	#294137	37T	OPTION
#305969	19T	OPTION	#294138	38T	OPTION
#305970	20T	OPTION	#294139	39T	OPTION
#305971	21T	OPTION	#294140	40T	OPTION
#305972	22T	OPTION	#294141	41T	OPTION
#305973	23T	OPTION	#294142	42T	OPTION
#305974	24T	OPTION	#294143	43T	OPTION
#305975	25T	OPTION	#294144	44T	OPTION
#294126	26T	OPTION	#294145	45T	OPTION
#294127	27T	OPTION	#294146	46T	OPTION
#294128	28T	OPTION	#294147	47T	OPTION
#294129	29T	OPTION	#294148	48T	OPTION
#294130	30T	OPTION	#294149	49T	OPTION
#294131	31T	OPTION	#294150	50T	OPTION
#294132	32T	OPTION	#294152	52T	OPTION
#294133	33T	OPTION	#294154	54T	OPTION
#305984	34T	OPTION	#294156	56T	OPTION
#305985	35T	OPTION	#294158	58T	OPTION
#294136	36T	OPTION	#294160	60T	OPTION

#901302 (SB M3x2.5)
OPTION (NOT INCLUDED)

Pinion
 (NOT INCLUDED)

Motor
 (NOT INCLUDED)

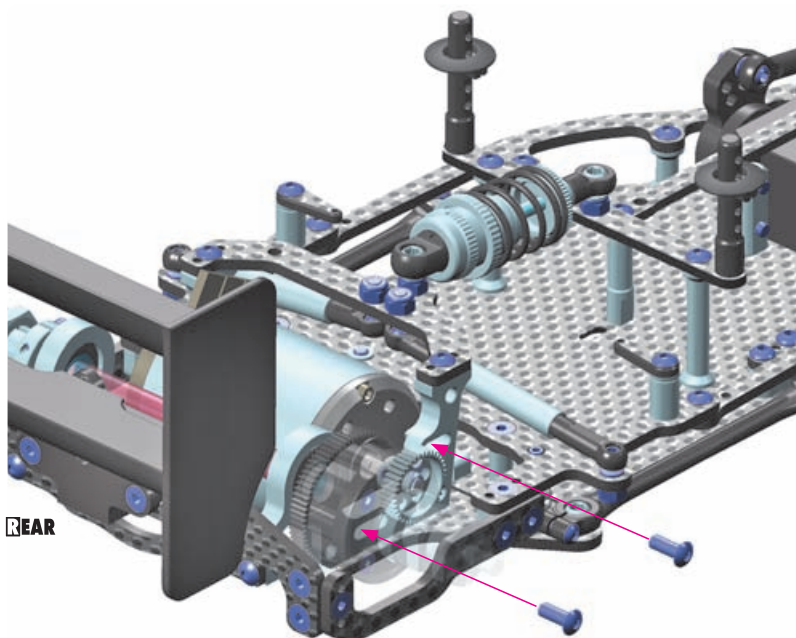
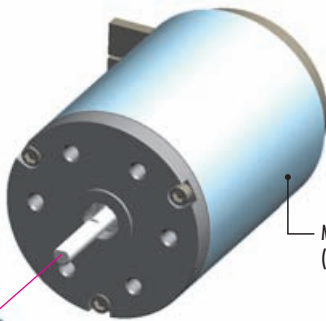

REAR

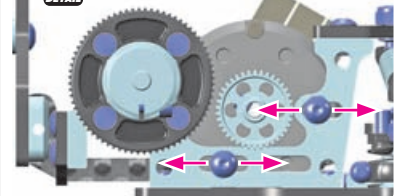

Adjust the gear mesh so there is appropriate space between the spur gear and pinion teeth. There should be a very small amount of freeplay.

5. FINAL ASSEMBLY



1x 903308 SFH M3x8

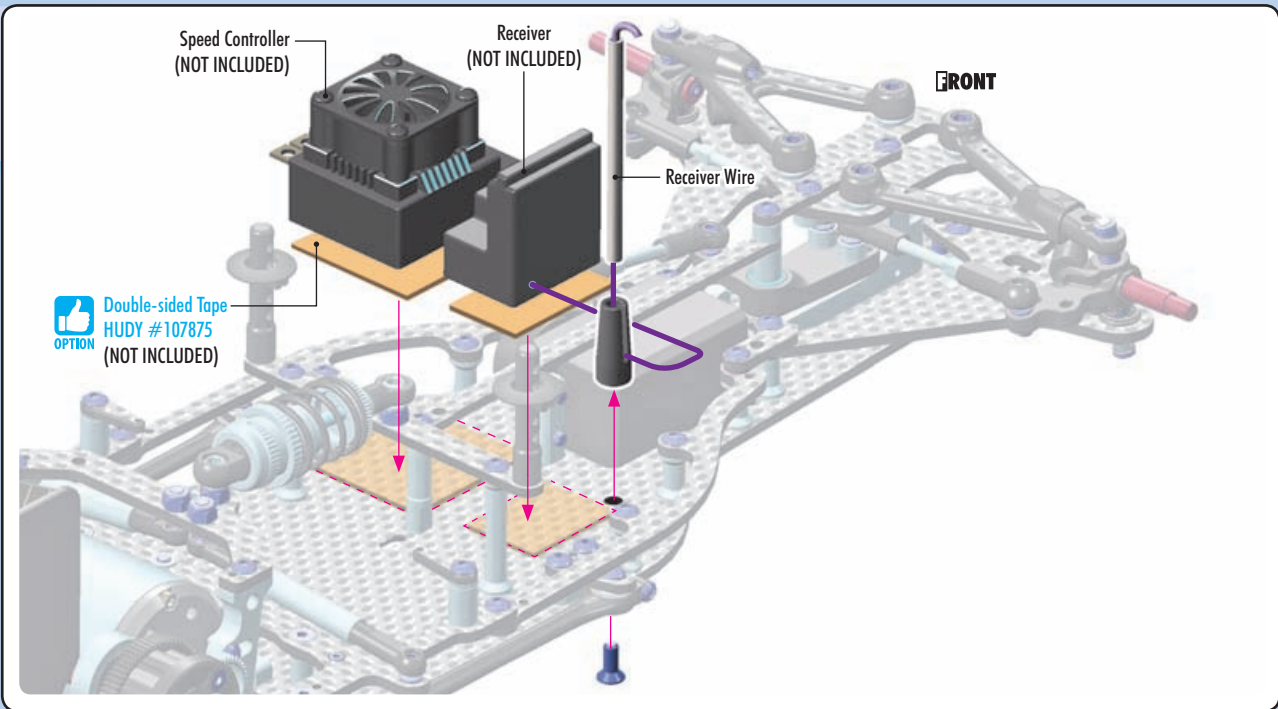

1x 903310 SFH M3x10



1x 960030 N M3

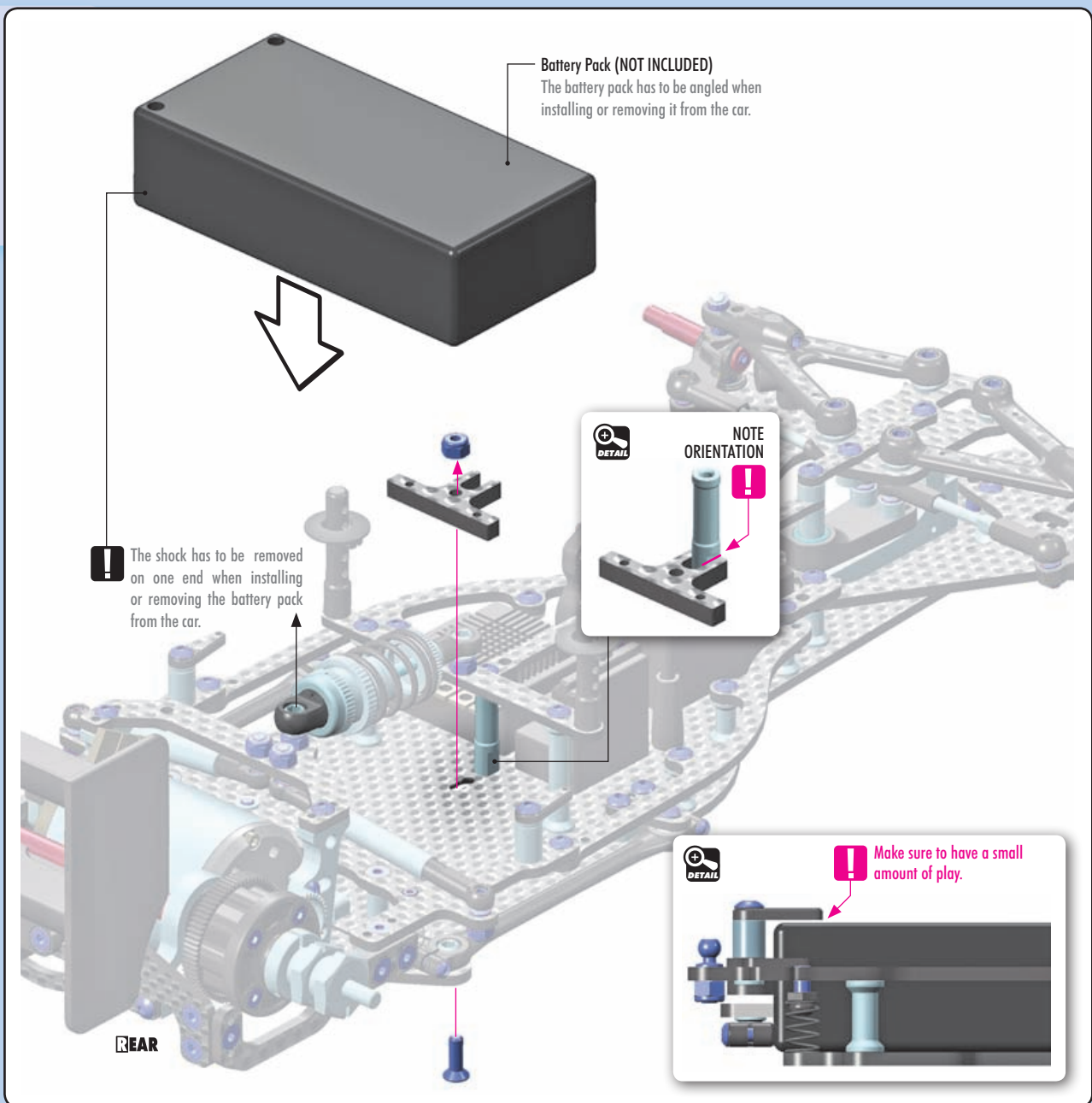

5. FINAL ASSEMBLY

BATTERY MOUNTING POSITIONS

The X1 has 3 battery mounting positions.

The **MORE FORWARD** the battery is, the car will be easier to drive but it will be less responsive.

The **MORE REARWARD** the battery is, the car will be more aggressive and have more steering.

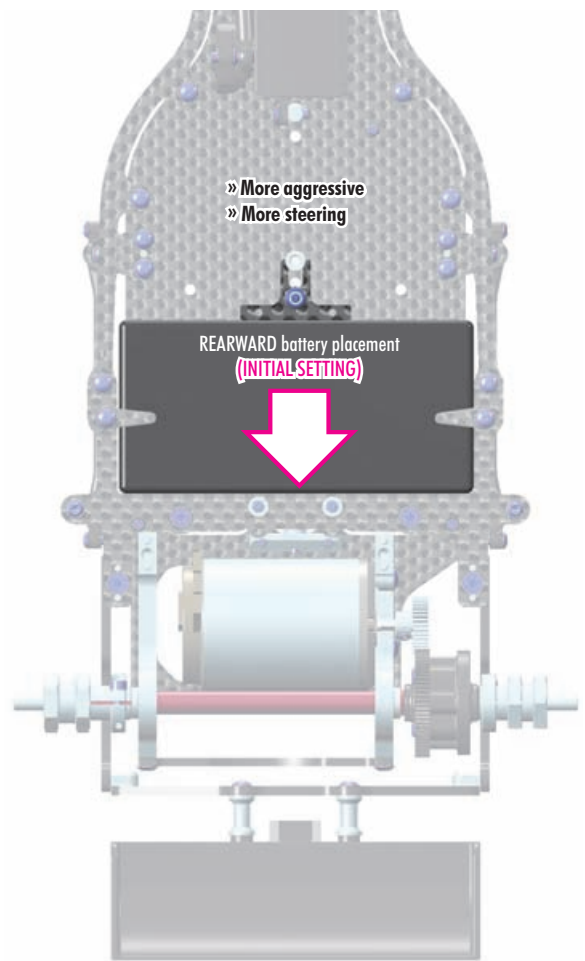
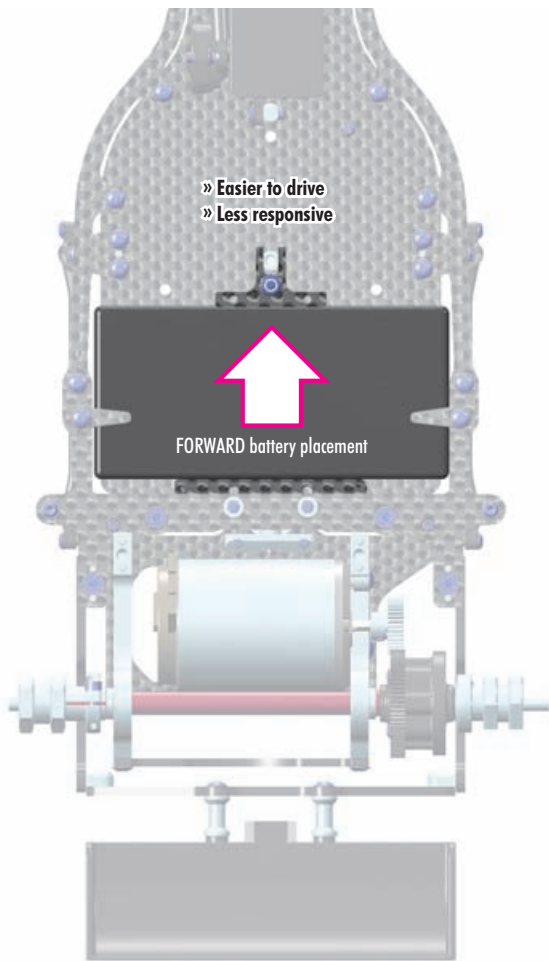

1x 903308
SFH M3x8



1x 981210
P 2x10

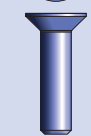

2x 903416
SFH M4x16

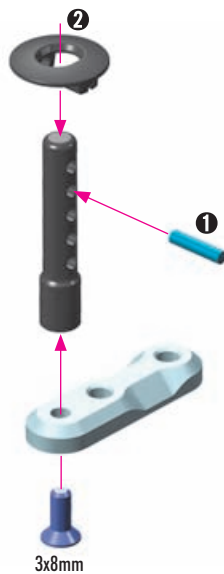

3x8mm

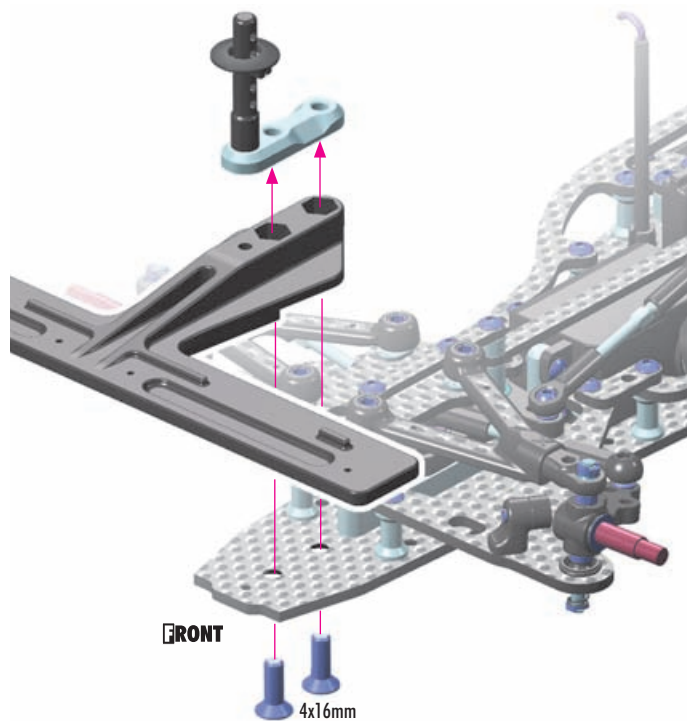

FRONT

4x16mm

5. FINAL ASSEMBLY

- Before cutting and making holes on the body, put the unpainted body on the chassis to confirm the mounting position and location for holes and cutouts. Before cutting and making holes on the front wing, put the unpainted wing on the front bumper to confirm the mounting position and location for holes and cutouts.
- Before painting, wash the inside of the body with mild detergent, and then rinse and dry thoroughly.
- Mask the helmet shield if you wish.

- Apply paint masks as appropriate.
- Paint the body using paints formulated for polycarbonate bodies.
- When the paint is dry, remove the masking.
- Carefully cut out the body using appropriate scissors or cutting tools.
- When you have finished cutting, peel off the external protective films.

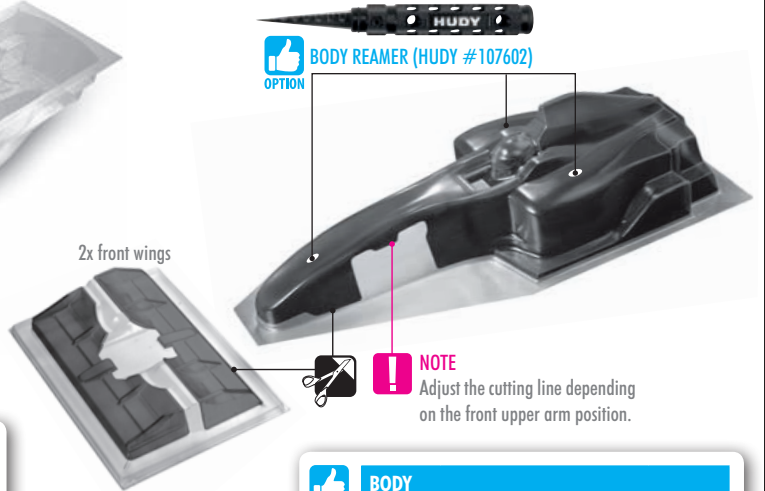
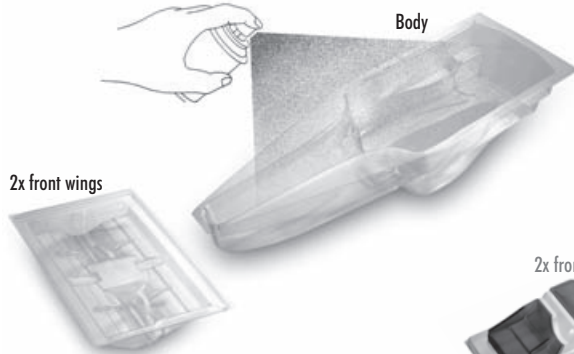

IMPORTANT

Most popular formula bodies will clear the chassis side braces. If a body does not have adequate clearance in the front nose area, installation may require body modification or removal of the side braces.

OPTION	BODY		OPTION
	#379701	XRAY	OPTION
	#379702	WORLD CHAMPION EDITION	OPTION

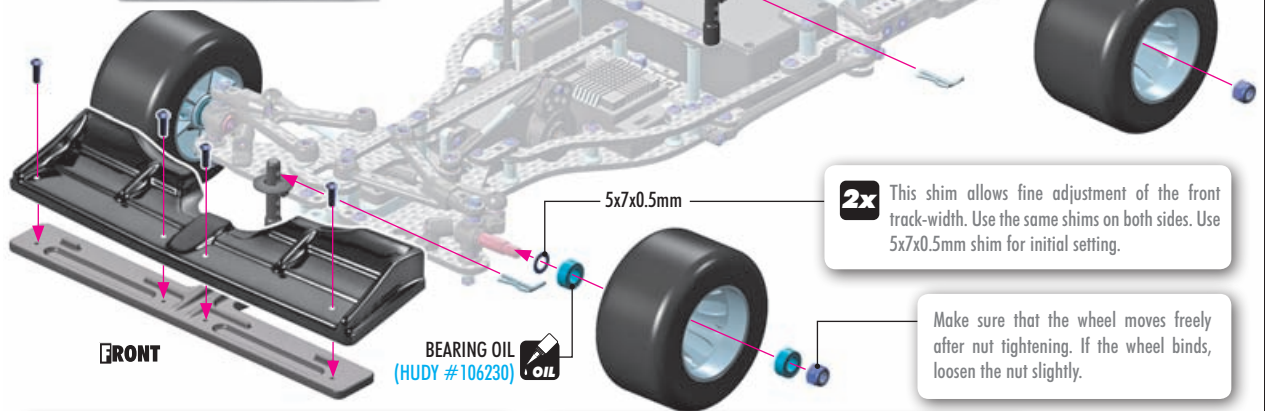
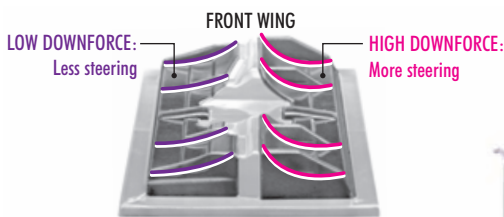
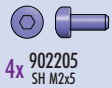

OPTION	#803072	HUDY 1/10 FORMULA RUBBER TIRE - FRONT (2)
	#803082	HUDY 1/10 FORMULA RUBBER TIRE - REAR (2)

OPTION	TRACK-WIDTH ADJUSTMENT SHIMS		
	#338584	5x7x0.2mm	OPTION
	#338585	5x7x0.3mm	OPTION
	#338586	5x7x0.5mm	INCLUDED



www.teamxray.com

XRAY EUROPE

XRAY, K VÝSTAVISKU 6992, 91101 TRENCIN, SLOVAKIA, EUROPE
PHONE: +421-32-740 11 00, FAX: +421-32-740 11 09, info@teamxray.com

XRAY USA

RC AMERICA, 2030 Century Center Blvd #15, Irving, TX 75062, USA
PHONE: 214-744-2400, FAX: 214-744-2401, xray@rcamerica.com



/TeamXray



/TeamXray



/TeamXray



/TeamXrayRC



/XrayRacing



/XrayRacing