

TRX4[®]

Front Assembly

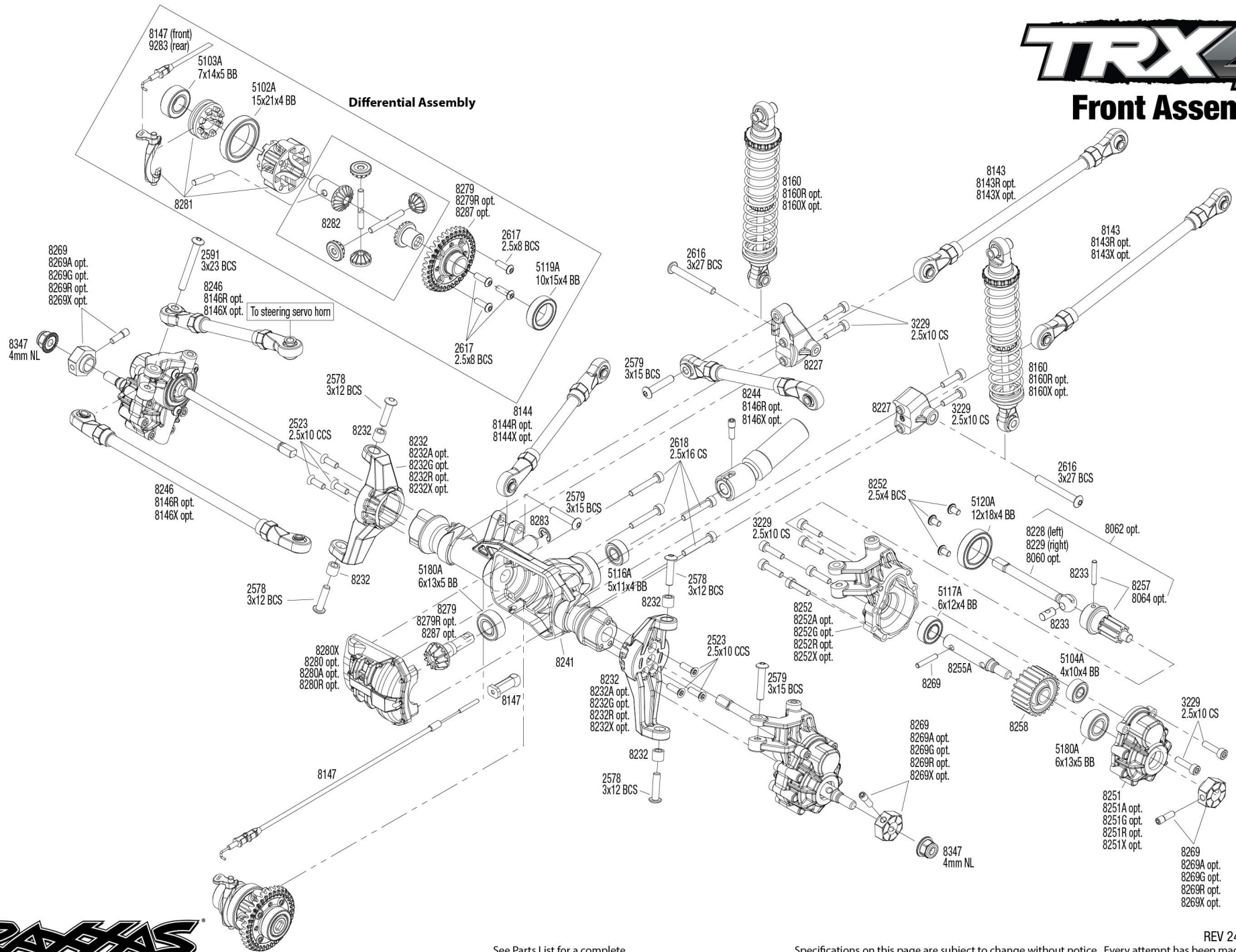

See Parts List for a complete listing of optional accessories.

Specifications on this page are subject to change without notice. Every attempt has been made to ensure the accuracy of this drawing; however, Traxxas cannot be held responsible for typographical or other errors.

REV 240408-R04

Link Dimensions

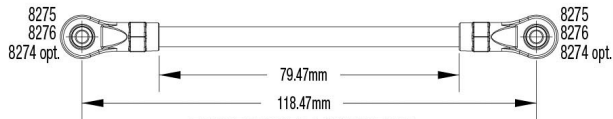

FRONT LOWER LINK (QTY. 2)

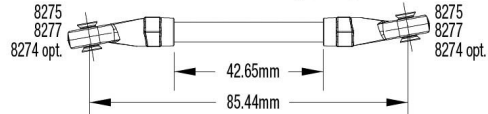

FRONT UPPER LINK (QTY. 1)

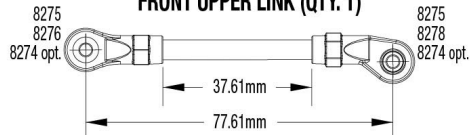

PANHARD BAR (QTY. 1)

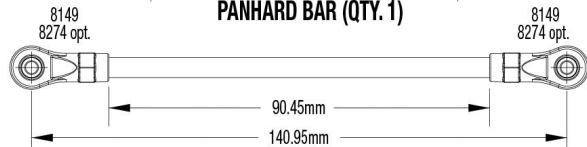

REAR LOWER LINK (QTY. 2)

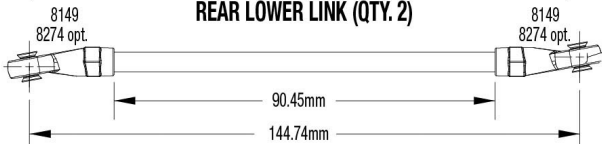

REAR UPPER LINK (QTY. 2)

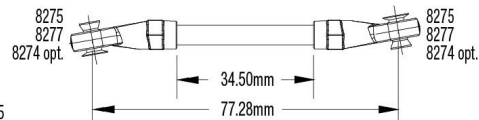

STEERING LINK (QTY. 1)

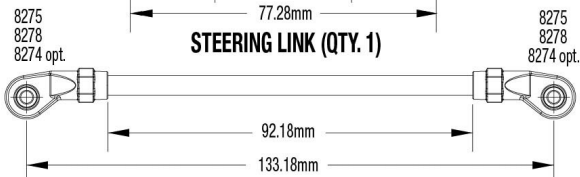

DRAG LINK (QTY. 1)

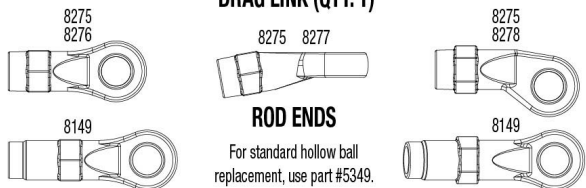

Modular Assembly

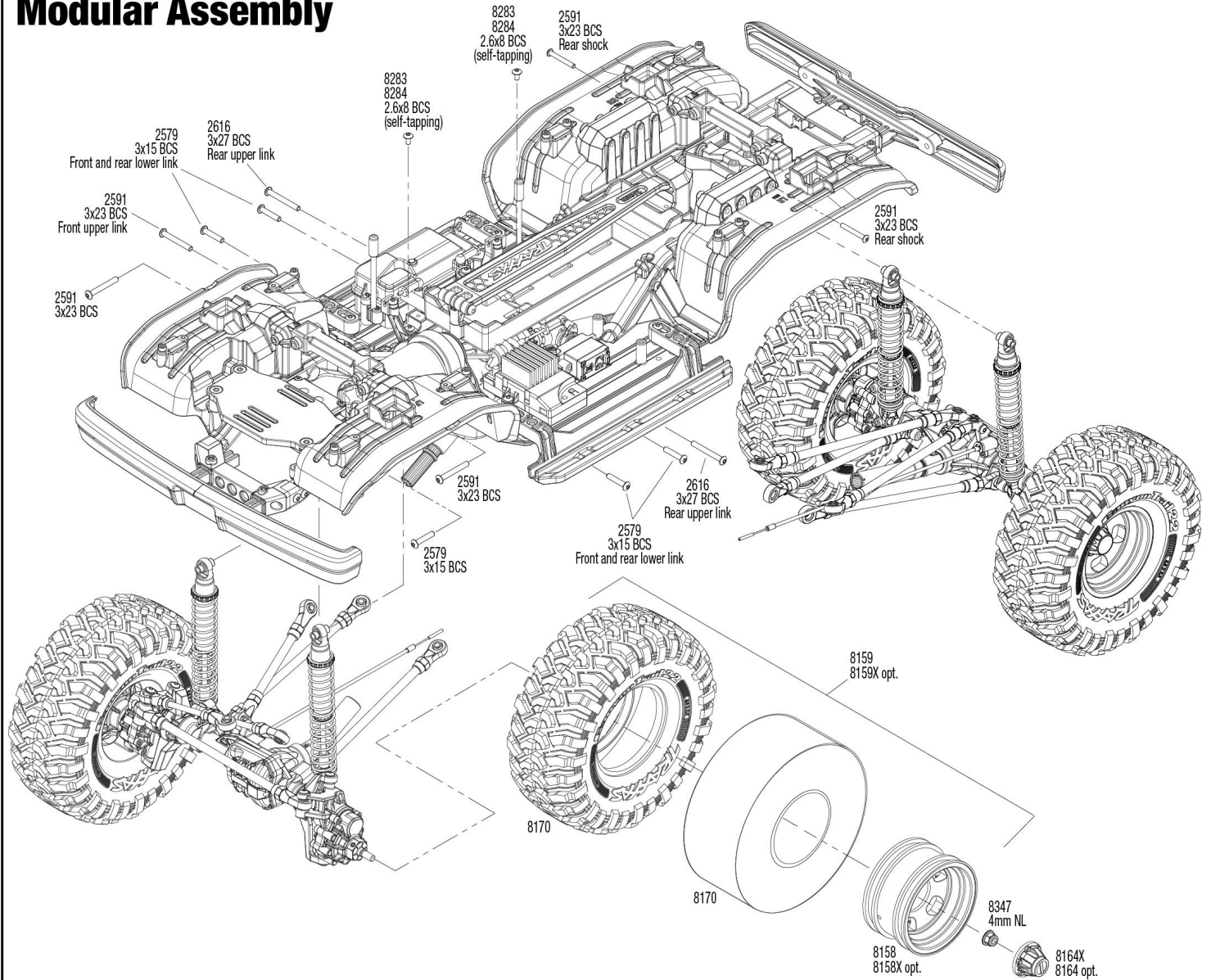

See Parts List for a complete listing of optional accessories.

Specifications on this page are subject to change without notice. Every attempt has been made to ensure the accuracy of this drawing; however, Traxxas cannot be held responsible for typographical or other errors.

Shock Assembly

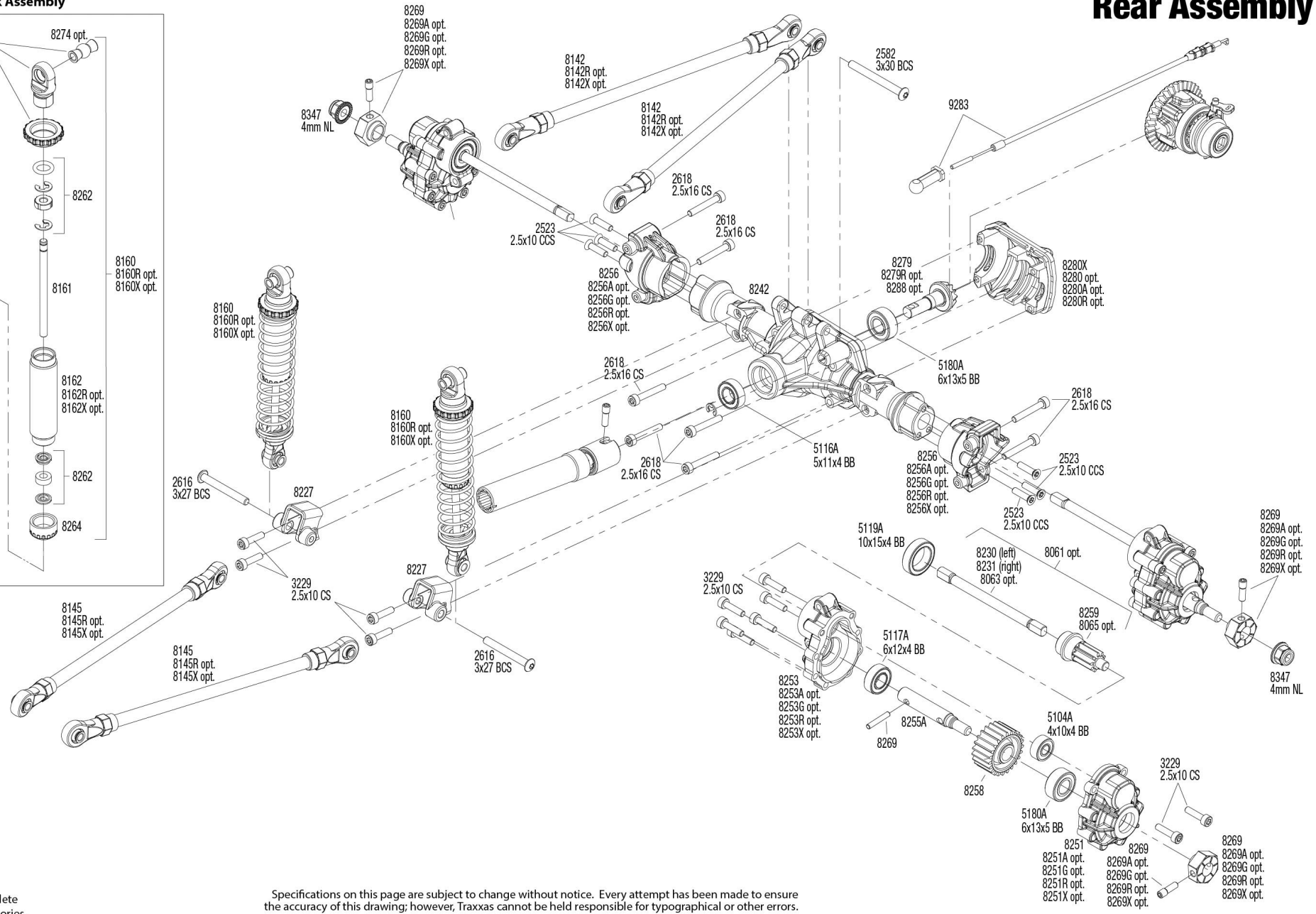
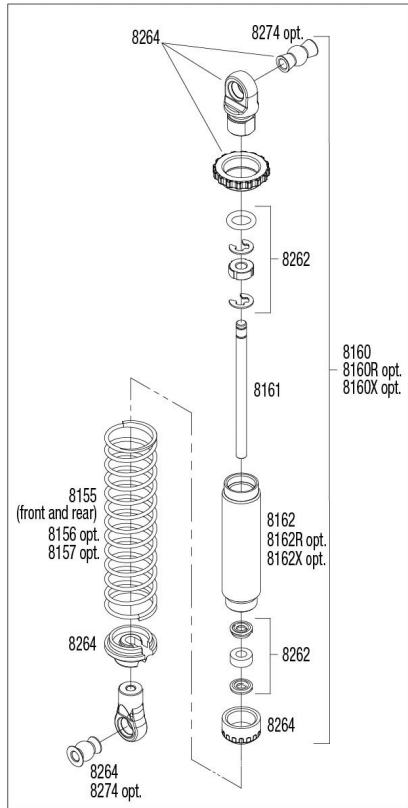



Driveshaft Length Indicators

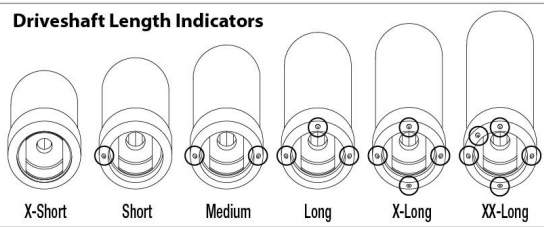

Transmission Assembly

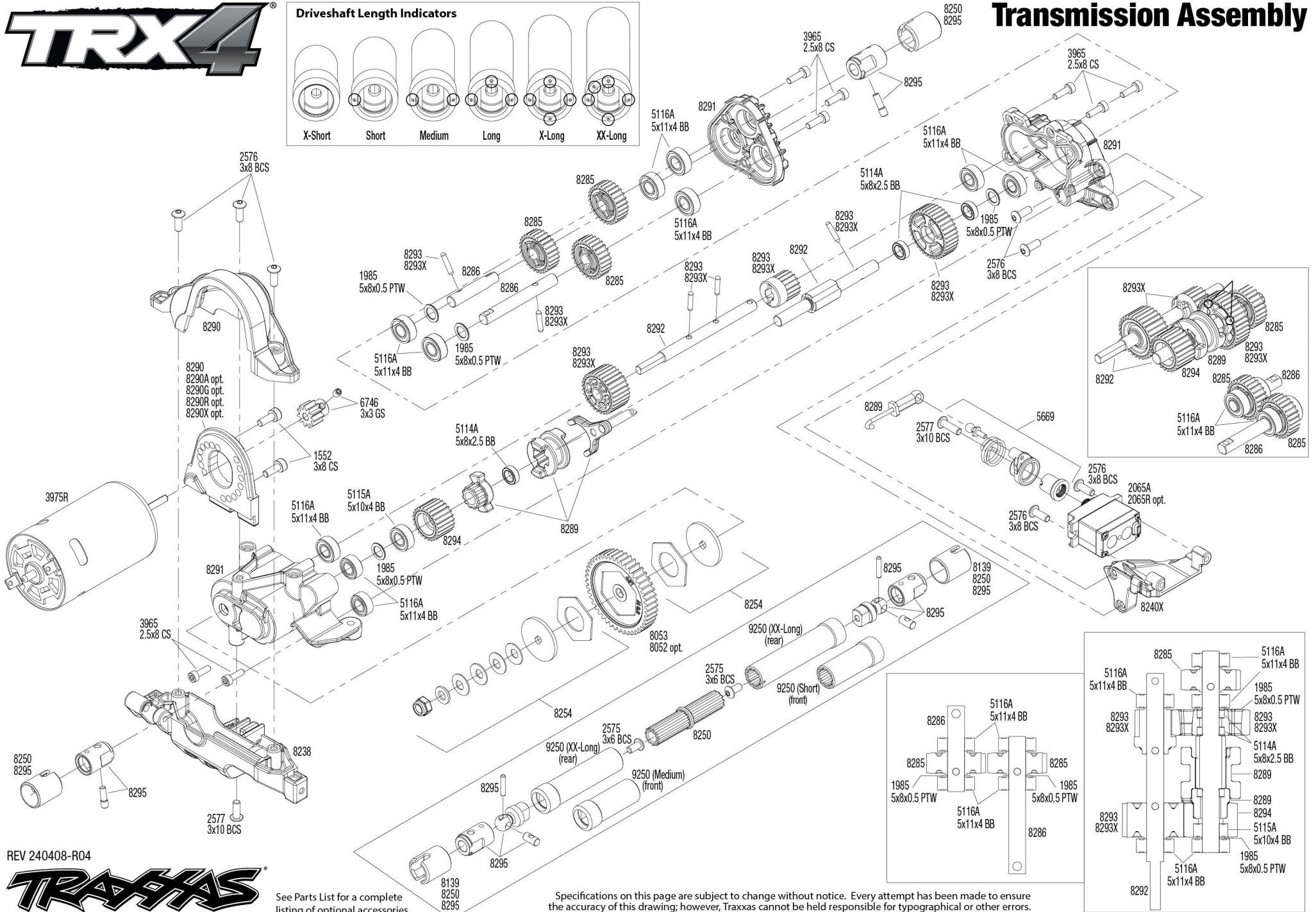

REV 240408-R04



See Parts List for a complete listing of optional accessories.

Specifications on this page are subject to change without notice. Every attempt has been made to ensure the accuracy of this drawing; however, Traxxas cannot be held responsible for typographical or other errors.