

Cessna 170

Cessna

DESIGNED BY:

Giuseppe Tompazini



SUPER PNP
Instruction Manual

PREMIER
aircraft™

TABLE OF CONTENTS

Introduction	1	Aura 8 AFCS.....	12
Box Contents.....	1	Receiver Installation/Servo Connections	12, 13
Specifications	2	Transmitter Control Direction Test	14
Completion Items	2	AFCS Sensor Direction Test	15
Battery Charging Guidelines	2	Battery Installation	16
Special Language Definitions	3	Center of Gravity	16
Important Information Regarding Warranty.....	3	Flying Your Cessna 170	17
Safety Warnings and Precautions	3	Learning Use Flaps	18
Low Voltage Cutoff.....	3	Advanced "3D" Cessna/Aura Setup	18
Rudder Installation	4	Airframe Repairs	19
Tailwheel Installation	4	Replacing Servos.....	19
Main Landing Gear Installation	5	Servicing the Power System	20
Propeller and Spinner Installation	6	Aircraft Troubleshooting Guide	21, 22
Horizontal Stabilizer Installation	7	Replacement Parts List	23
Main Wing Installation.....	8, 9	Optional Parts List	23
Night Cessna LED Connections	10	Limited Warranty	24
Transmitter Setup.....	11	AMA Safety Code.....	25

INTRODUCTION

The Cessna 170 and the Aura 8: the perfect combination!

The Cessna 170 is the evolution and accumulation of many years of experience in the aerodynamic and electronic stabilization world. A perfectly tuned airframe design, combined with today's most advanced control system gives an unmatched flying experience.

Pilots will feel smooth, precise aircraft control without any interference to pilot inputs. The aircraft will fly as if it were much larger, turbulent air will be less noticeable, rotations will stop more precisely and landing will be easier to execute. Flex Innovations has tuned and matched both to their best potential, however, the Aura 8 programming capability allows total freedom to the pilot to adjust (including setting flight modes that can turn it off). USB firmware update capability allows you to enjoy and benefit from the latest features and advancements.

For the latest updates, features, addendums and more, before assembly, please visit:

<http://wiki.flexinnovations.com/wiki/Cessna170>

- Low wing loading offers superb stability at slow speed.
- Custom-tuned Aura 8 gyro stabilization system provides the ultimate in stability and control
- Powerful 60-sized motor provides the punch for demanding tasks
- High-precision digital servos with full metal gears
- Light weight EPO foam is stiff and tough
- Hollow carbon and plywood-reinforced wing is stiff and lightweight
- Custom-designed control horns to maximize control geometry and performance
- Bush wheels to handle rough terrain and enhance the scale appearance

BOX CONTENTS



SPECIFICATIONS

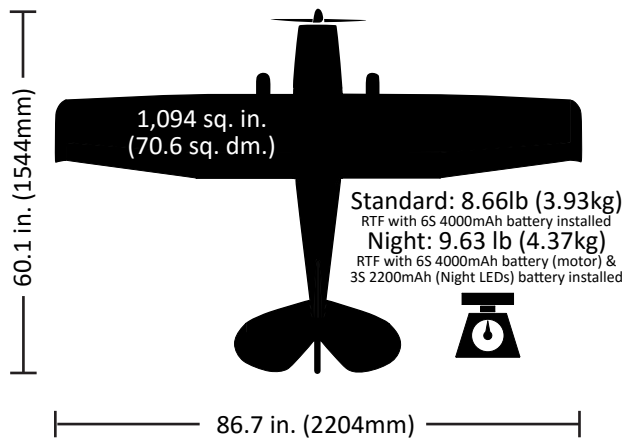

BATTERY CHARGING GUIDELINES

The assembly of the Cessna 170 can be accomplished in less than one hour. Prior to assembling the airplane, it is advisable to charge your battery so that you are ready to begin setup upon completion of the assembly of your model.

We recommend the use of an advanced LiPo balancing charger, such as our Potenza C80 Multi Chemistry Touch Screen AC/DC balancing charger for your batteries to get the maximum performance and lifespan.

Our airplanes are designed around our Potenza LiPo batteries, and we recommend the Potenza 4S 5000mAh 40C LiPo, the 5S 5000mAh 40C LiPo, and the 6S 4000mAh 40C LiPo in the Cessna 170 based on our extensive testing and development. These batteries feature an EC5 connector, so no soldering is required for use in your Cessna.

All are available at www.flexinnovations.com or at your local retailer.

WARNING

FOLLOW ALL INSTRUCTIONS PROVIDED BY YOUR BATTERY AND CHARGER MANUFACTURER. FAILURE TO COMPLY CAN RESULT IN FIRE.

COMPLETION ITEMS

INSTALLED!		Potenza 60L 540 Kv Brushless Outrunner Motor (FPZM1060L)
INSTALLED!		HobbyWing SkyWalker 80A ESC with 5V/8A External BEC (FTVHWBQ8012EB)
INSTALLED!		Potenza DS33 and DS19 Digital Servos (FPZDS33 & FPZDS19)
INSTALLED!		Aura 8 Advanced Flight Control System (FPZAURA08ZZC17)
INCLUDED!		16 x 6 Electric SR Propeller (FPMP1606E)
NEEDED TO COMPLETE		Hot Aerobatics: 3300-5000mAh 6S 22.2V 40C+ LiPo (FPZB40006S40), (FPZB50006S40) Sport Aerobatics: 3300-5000mAh 5S 18.5V 30C+ LiPo (FPZB40005S40) Sport/Scale: 3300-5000mAh 4S 14.8V 30C+ LiPo (FPZB50004S40)
NEEDED TO COMPLETE		6-Channel Computer Transmitter
NEEDED TO COMPLETE	 <i>Receiver</i>	DSM2/DSMX Remote Receivers (x2)/ SRXL/S.Bus Futaba/Graupner HOTT JR XBus/Jeti UDI 6+ Channel RX (any brand)

OPTIONAL ACCESSORIES

FPM317014	Cessna 170: Float Set & Struts w/ LED Light
FPM317015	Cessna 170: Fixed Slat Set
FPM317016	Cessna 170: Snow Ski Set
FPM317018	Cessna 170: Key Chain Camera Mount
FPZB40006S40	Potenza 6S 4000mAh 40C Li-Po Battery
FPZB50006S40	Potenza 6S 5000mAh 40C Li-Po Battery
FPZB50006S60	Potenza 6S 5000mAh 60C Li-Po Battery
FPZB50005S40	Potenza 5S 5000mAh 40C Li-Po Battery
FPZB50004S40	Potenza 4S 5000mAh 40C Li-Po Battery
FPZC80	C80 Multi-Chemistry Touch Screen AC/DC Charger
FTVHWBQ2006	Hobbywing ESC Programming Card
FPZA1010	Potenza Multi-Function Digital Battery Analyzer



SPECIAL LANGUAGE DEFINITIONS

The following terms are used throughout the product literature to indicate various levels of potential harm when operating this product:

- NOTICE:** Procedures, which if not properly followed, create a possibility of physical property damage AND a little or no possibility of injury.
- CAUTION:** Procedures, which if not properly followed, create the probability of physical property damage AND a possibility of serious injury.
- WARNING:** Procedures, which if not properly followed, create the probability of property damage, collateral damage, and serious injury OR create a high probability of serious injury.



WARNING

AGES 14+

This product is not intended for use by children under 14 years without direct adult supervision.

ATTENTION

Read the ENTIRE instruction manual to become familiar with the features of the product before operating. Failure to assemble or operate the product correctly can result in damage to the product, personal property, and cause serious or fatal injury.

All instructions, warranties and other collateral documents are subject to change at the sole discretion of Flex Innovations, Inc. For up-to-date product literature, please visit our website at www.flexinnovations.com and click on the Cessna 170 and Aura 8 product pages.

IMPORTANT INFORMATION REGARDING WARRANTY

Please read our Warranty and Liability Limitations section before building this product. If you as the Purchaser or user are not prepared to accept the liability associated with the use of this Product, you are advised to return this product immediately in new and unused condition to the place of purchase.

SAFETY WARNINGS AND PRECAUTIONS

Protect yourself and others by following these basic safety guidelines.

1. This manual contains instructions for safety, operation and maintenance. It is essential to read and follow all the instructions and warnings in the manual, prior to assembly, setup or use, in order to operate correctly and avoid damage or serious injury.
2. This model is not a toy, rather it is a sophisticated hobby product and must be operated with caution and common sense. This product requires some basic mechanical ability. Failure to operate this product in a safe and responsible manner could result in injury or damage to the product or other property.
3. This model must be assembled according to these instructions. Do not alter or modify the model outside of these instructions provided by Flex Innovations, Inc. as doing so may render it unsafe and/or unflyable. It is your responsibility to ensure the airworthiness of the model.
4. Inspect and check operation of the model and all its components before every flight.
5. If you are not an experienced pilot or have not flown a high-performance model before, it is recommended that you seek assistance from an experienced pilot in your R/C club for your first flights. If you're not a member of a club, the Academy of Model Aeronautics (AMA) has information about clubs in your area whose membership includes experienced pilots.
6. Keep the propeller area clear from such items as loose clothing, jewelry, long hair, or tools as they can become entangled. Keep your hands and body parts away from the propeller as injury can occur.
7. Never fly in visible moisture, or submerge the airplane or any of its electronic components in water. Permanent damage to electronic components may occur, or corrosion of components may lead to intermittent failures.

LOW VOLTAGE CUTOFF

LiPo batteries have a nominal (rated) voltage of 3.7V per cell, and fully charged, reach 4.2V per cell. Batteries are designed to be discharged below the nominal voltage, however, if they are discharged below 3.0V per cell, damage will occur and the pack will lose capacity. For best long term battery life, set a timer and land after a time that leaves approximately 15% of the battery's capacity remaining.

Low voltage cutoff is a feature that is built into the Hobby Wing SkyWalker 80A ESC that is designed to protect the connected battery from being discharged too far and causing permanent damage to the cells. Circuitry within the ESC will automatically detect when the input voltage from the battery pack reaches below 3.15V per cell (average) and will remove power to the motor, but still deliver power to the servos so that a safe landing may be made. If the motor begins to lose power rapidly during flight, the LVC has sensed that the total voltage of the pack has dropped below 3.15V per cell average, and the airplane should be landed immediately.

RUDDER INSTALLATION

Required Tools and Fasteners: Medium CA
2mm Hex Driver

3 - M3x10 Hex Head Self-Tapping Screw

1. The rudder comes pre-hinged to a small section of vertical fin. Test fit the rudder and fin section onto the fuselage. Remove it from the fuselage once fit is confirmed.
2. Lay the fuselage on its side, and using medium CA (foam-safe is not required), apply an adequate amount to the fuselage. Press the rudder and vertical fin section into the fuselage, being sure to wipe away any excess CA.
3. Secure the lower plastic support in place by threading an M3x10 hex head self-tapping screw through the bottom of the plastic part in the fuselage. Do not fully tighten, as you can cause the rudder to bind. A small amount of play is needed here.
4. Allow time for the CA to dry, and once dry, check for proper rudder movement. Be sure the rudder moves freely with little to no binding.
5. Press the tailwheel wire into the plate on the bottom of the rudder. Lay the tailwheel plate over the wire, and secure it in place with two M3x10 hex head self-tapping screws.

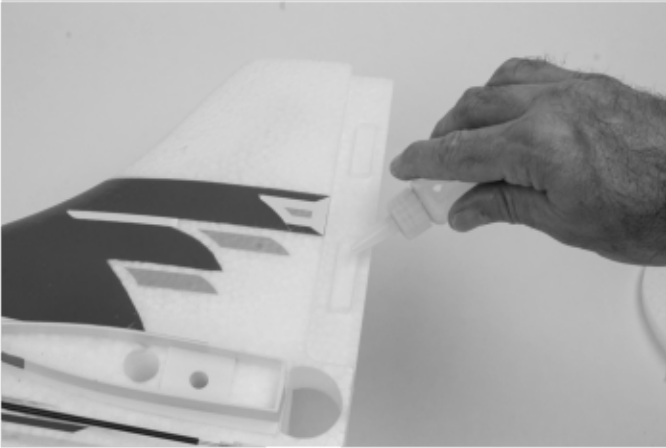

5. Connect the rudder clevis to the innermost hole in the control horn. Slide the clear tubing over the clevis to secure it in place. After assembly is complete, and your receiver is bound and transmitter properly set up, center the rudder by turning the clevis in or out as needed. Use the rudder counter balance and fixed portion of the vertical fin for reference. **Do NOT use trim or sub-trim.**

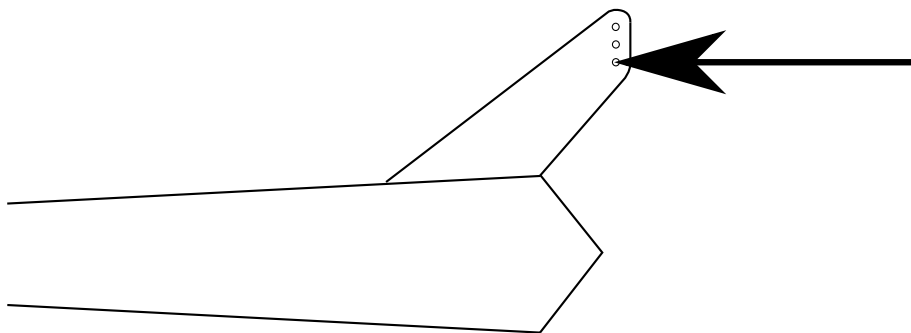

MAIN LANDING GEAR INSTALLATION

Required Tools and Fasteners: 2mm Hex Driver
1.5mm Hex Driver

4 - M3x10 Hex Head Self-Tapping Screws
2 - M5 Lock Collars, with Set Screws
2 - M5 Spacer

1. Slide an M5 spacer over the landing gear wire.
2. Slide a main wheel over the landing gear wire, followed by a lock collar. Add a drop of blue thread lock to the set screw, and secure it in place. Repeat for the other wheel.

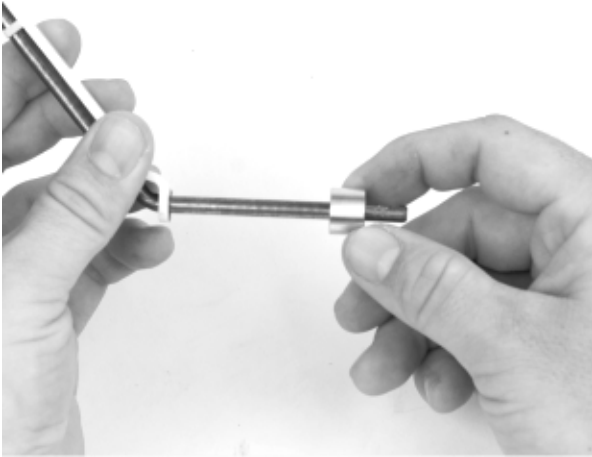

1. Push the landing gear wire into the bottom of the fuselage. Orientation of the wire landing gear does not matter, however, the plastic wire covers are directional. You should have more material AFT of the landing gear wire. Insert the plastic landing gear keeper after the landing gear, noting orientation. The plastic part will sit flush in one orientation, but in the wrong direction, may not sit flush.
2. Secure the plastic landing gear plate into the fuselage using 4 M3x10 self-tapping hex head screws. Do not overtighten.



PROP ADAPTER, PROPELLER AND SPINNER INSTALLATION

Required Tools and Fasteners:

2.5mm Hex Driver	3 - M3x9 Hex Head Machine Screws
#1 Phillips Screwdriver	1 - M3x30 Phillips Head Machine Screw
Adjustable Wrench	1 - Prop Washer
Blue Thread Lock	1 - Propeller Nut

Note: It is important to check the rear motor shaft collar and set screw for thread lock before first flights. If no thread lock is found, remove the set screw, add blue thread lock, and re-secure. It is always a good idea to check all hardware connections every few flights to ensure they stay tight.

Note: Do not complete transmitter, receiver and/or Aura setup with the propeller installed.

1. Locate the bolt-on prop adapter for the motor. Apply blue thread lock to each of the three M3x9 hex head machine screws, and secure the prop adapter to the motor. Make sure that the propeller adapter seats fully against the motor face, and is concentric with the motor shaft.
2. Install the spinner backplate onto the motor shaft. Ensure that it is fully seated.
3. Install the propeller with the convex surface facing forward. The propeller size numbers are printed on the front face of the prop and should orient forward.
4. Slide the prop washer on the shaft with the widest face aft, and tighten the prop nut.
5. Install the spinner cone, and tighten the M3x30 Phillips Head screw using a #1 Phillips screwdriver. Do not apply blue thread lock and do not over tighten.

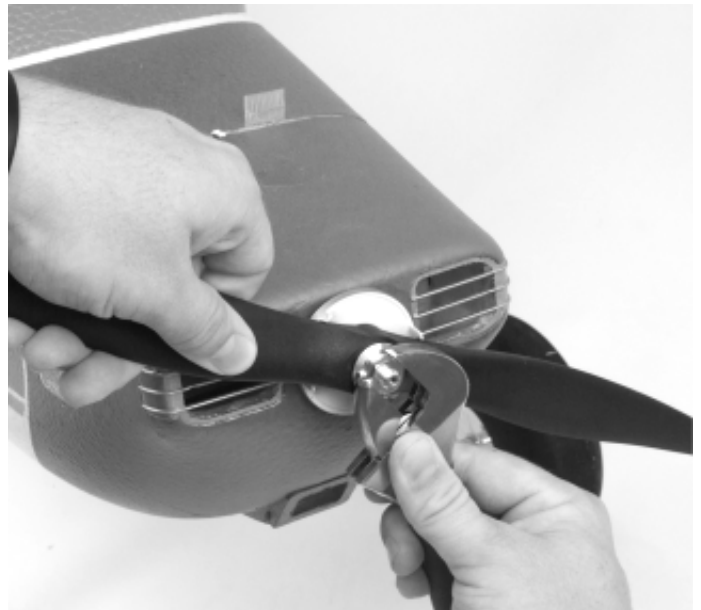

HORIZONTAL STABILIZER INSTALLATION

Required Tools and Fasteners: Clear Tape (4 Strips)

1. Insert the horizontal stabilizer tube into one of the horizontal stabilizer halves.
2. Slide the tube through the hole in the fuselage, being sure to orient the control horn towards the bottom of the airplane. Do not force it into place.
3. Slide the other stabilizer half onto the tube, being sure to index the elevator joiner tabs into one another. Do not force it into place.
4. Apply 4 pieces of clear tape to the joint between the stabilizer and the plastic mounts. Be sure to apply tape to both the top and bottom sides of the stabilizer.
5. Attach the clevis to the elevator control horn in the innermost hole. Slide the clear tubing over the clevis to secure it in place.

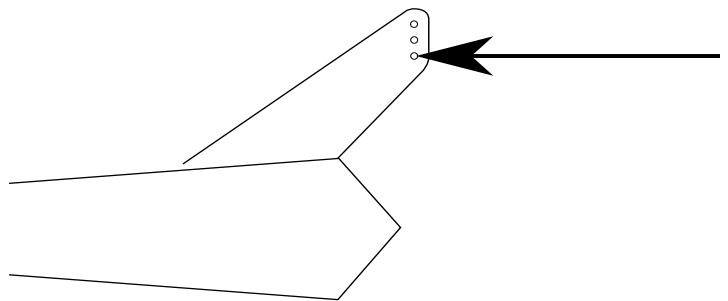
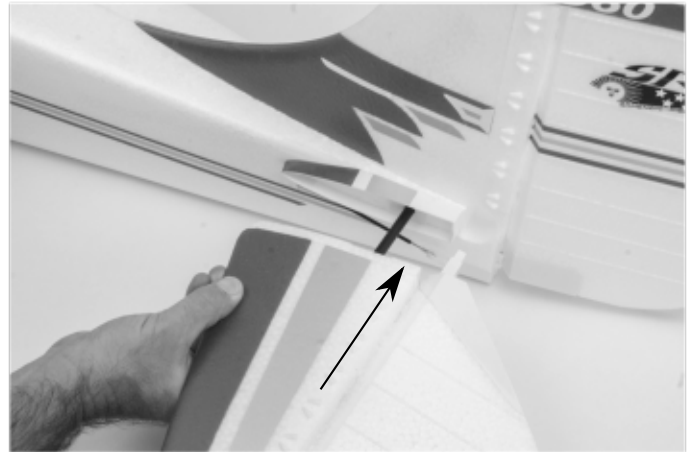
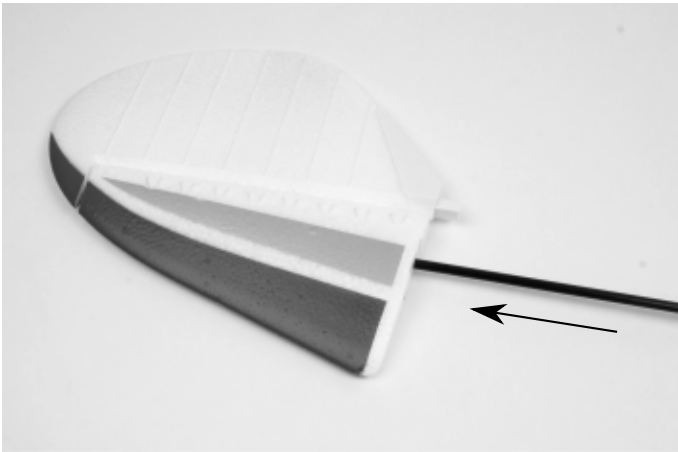

MAIN WING INSTALLATION

Required Tools and Fasteners: 2.5mm Hex Driver

4 - M3x25 Hex Head Machine Screws

4 - 6mm Strut Retaining Pins

4 - Strut Retaining Pin Keepers

1. Insert the main wing tube into one of the main wing halves.
2. Slide the tube through the hole in the fuselage. Make any necessary servo or light connections (reference Night LED Connections page if you have purchased the Night Cessna). Note that the aileron and flap extensions are marked accordingly. Slide the wing fully into the plastic mounts, while taking special care to prevent any wires from being pinched when installing the panel.
3. Slide the other wing half onto the tube, and make any connections as completed in the previous step. Fully seat the wing into the plastic mounts in the fuselage. Do not force it into place.
4. Secure each wing panel to the fuselage using 2 M3x25 hex head machine screws. Don't over tighten.



MAIN WING INSTALLATION (CONTINUED)

- Note which wing strut goes to each wing panel, and which end goes to the wing and to the fuselage. The struts are labeled R and L at one end of the strut. Also note that there are two different strut retaining pins; one that is shorter (A) and one that is longer with a "D" shaped head (B). Pin A goes to the fuselage side, and Pin B goes to the wing side of the strut.
- Insert a strut retaining pin through the end of the strut AND the mount in the wing. Slide a retaining pin keeper through the hole in the retaining pin to secure it in place.
- Repeat step 6, but for the plastic mount in the bottom of the fuselage. The strut goes ABOVE the mount in the fuselage. Note that for faster field assembly, it is recommended to leave the strut attached to the wing panel, and only remove it from the fuselage. The strut will lay flat on the wing for storage.
- Confirm the linkage locations in the servo arm and control horn for both flaps and ailerons, referencing the images below. Adjust as necessary. Note that the flap servo will NOT be centered when the flap is in the up position. This is proper, and intentional in

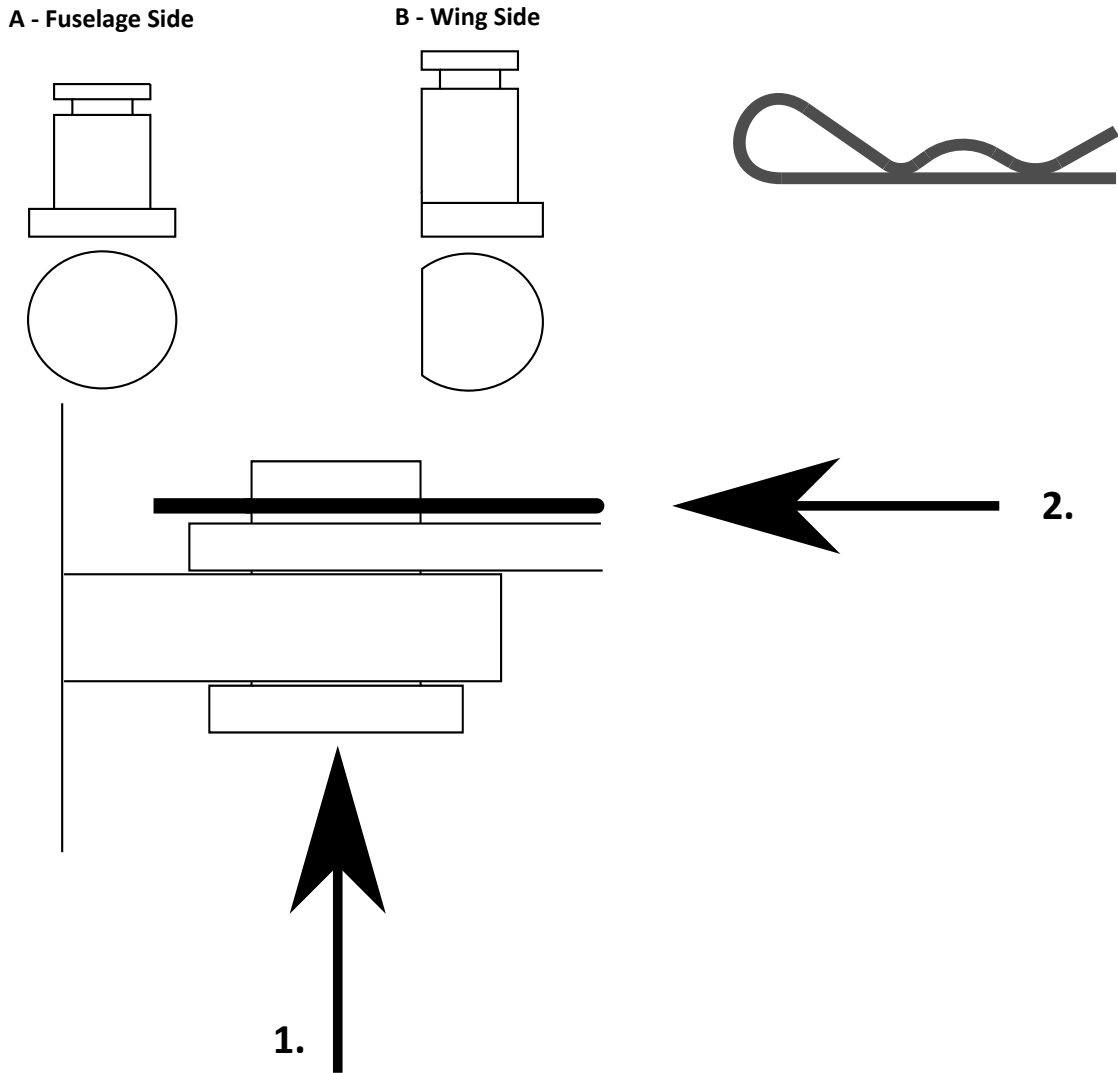

MAIN WING CONTROL LINKAGE SETUP
 Note: Aileron Differential has been tuned with Aura

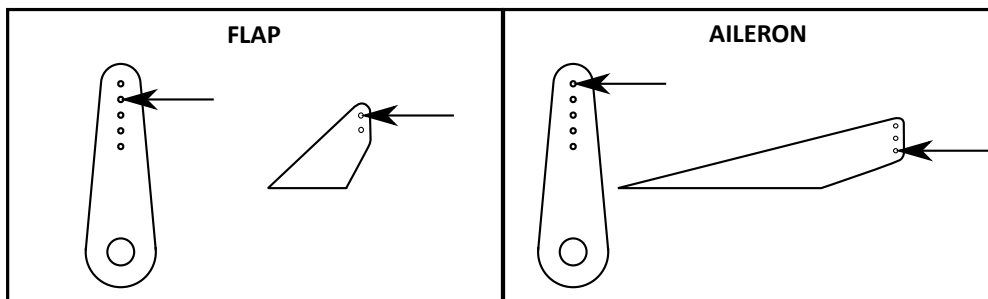

NIGHT CESSNA LED CONNECTIONS

If you have purchased the Night version of the Cessna, this page will cover all LED light connections. If you did not purchase the night version, skip ahead to the next page.

In order to power the internal Night LED lights (not wing tip or landing lights) you will need to use a separate 3S Lithium-Polymer battery. We recommend the Potenza 3S 2200mAh 40C Li-Po (FPZB22003S40). Average current draw for the lighting system is 2.2A/h.

1. There are two connections for each wing panel, one at the leading edge, and one at the trailing edge of the wing. Connect the one at the trailing edge to the installed JST extension. Route the connector at the leading edge through the hole in the fuselage and plug into the LED controller directly.
2. If using the floats with lights, connect each JST for the float set to the LED controller in the fuselage. Route the leads through the cooling hole in the bottom of the fuselage. Secure the wire to the flat strut and fuselage using water proof tape.
3. The fuselage LED strip is pre-connected to the LED controller for you. Should it become disconnected, connect it to one of the four JST connectors on the LED controller.
4. Connect the balance tab (JST-XH) of any 3-Cell (12V DC) Li-Po battery (greater than 1300mAh, and 20C) to the balance tab adapter on the LED controller. When connected, the lights are automatically powered. Turn to the LED lights off, disconnect the battery from the LED controller.
5. The LED controller defaults to a non-flashing mode. It has different flashing modes, and different flashing speeds available. Simply select the speed or mode by pressing the button(s) on the LED controller until a desired setting is reached.

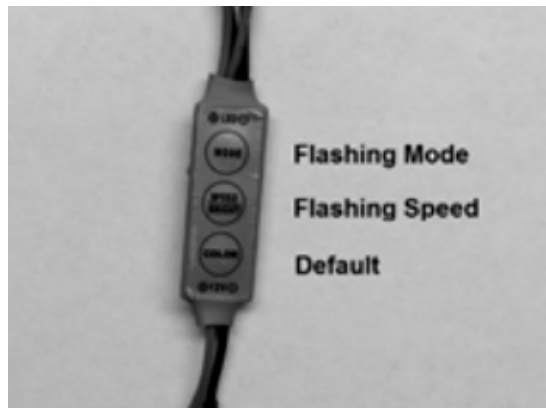
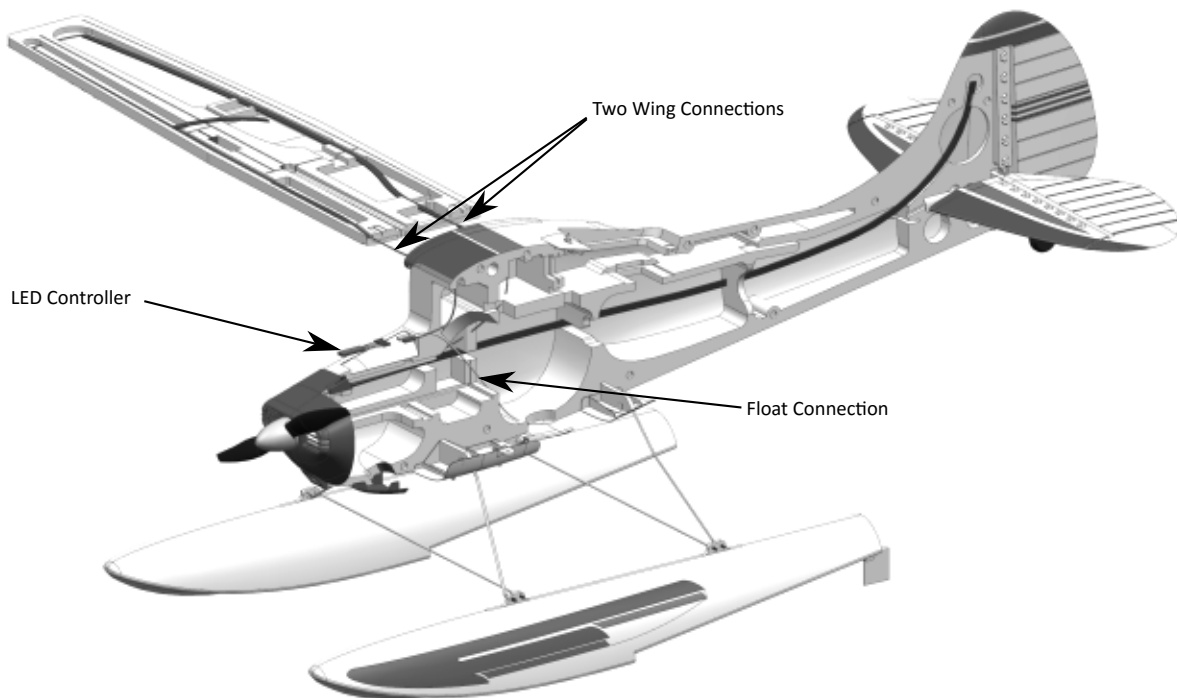

! WARNING

DO NOT ATTEMPT RADIO SETUP WITH PROPELLER INSTALLED. INADVERTENT POWER UP COULD CAUSE PERSONAL INJURY.

TRANSMITTER SETUP

Begin by starting with a freshly reset and new model memory in your transmitter. Make **ONLY** the changes shown in the Transmitter Setup Guide.

The Aura 8 on the Cessna 170 defaults to 3 flight modes that are switched via CH5/Gear in your transmitter. You may need to reassign CH5/Gear to a 3-position switch. Consult your radio manual for directions on channel assignment.

Description of Pre-Loaded Aura Flight Modes (FM)

FM 1: Flight Control system is off. Rates are set for general flight (same as FM 2). Exponential is tuned for comfortable flight. **Rudder to aileron and rudder to elevator mix active.**

FM 2: Flight Control system is on. Gains are moderate and tuned for comfortable feel/best performance. Rates are set for general sport flying, and expo is tuned for comfortable flight. **Rudder to aileron and rudder to elevator mix active.**

FM 3: Flight Control system is on. Gains are moderate and tuned for comfortable feel/best performance. Rates are set for aggressive flying, and expo is tuned for comfortable flight. **Rudder to aileron and rudder to elevator mix active.**

Note: Rudder stick movement will also move ailerons and elevator. This functionality is NORMAL.

Each of the modes has been tuned by our team to offer a solid start. Because tastes in control feel are unique, if changes in rates and expo are needed, adjustments should be made through the Aura 8. Changes in gain value can only be made via Master Gain, or through the Aura Config Tool (Windows Application).

For large (greater than 5%) changes in expo, or dual rates, it is highly recommended to reset all expos and rates to default in the transmitter, and tune through the Aura Config Tool.

The Aura Config Tool can be used on any Windows-based PC or Tablet, and can be downloaded at the following address:

www.flexinnovations.com/articles.asp?ID=257

TRANSMITTER SETUP GUIDE

End Points*	Aileron/Elevator/Rudder	125%
	Throttle	100%
Sub Trim	Verified at zero, sub-trim not allowed	
Trim Levers	Verified at zero	
CH. 5 (Gear)	Assigned to a 3-position switch	
CH. 6 (AUX1)	Assigned to a 3-position switch OR Flap System If using flap system, assign 100%, 0%, -100%	
Reversing	Ail/Ele/Rudder set to Normal Thro/Flap depends on transmitter manufacturer	
Timer	Set to 4:00 for initial flights	

*Note: JR Mode B Users set Throttle, Aileron, Elevator, Rudder and Gear Travels to 88%

AURA FLIGHT MODE REFERENCE

Note: These are for reference only. DO NOT put these values into your transmitter.

		Mode 1	Mode 2	Mode 3
Aura 8 Rate Setup	Aileron	70%	70%	100%
	Elevator	45%	45%	100%
	Rudder	100%	100%	100%
		Mode 1	Mode 2	Mode 3
Aura 8 Expo Setup	Aileron	30%	10%	15%
	Elevator	30%	15%	40%
	Rudder	40%	35%	35%

CONNECTING BATTERY/ARMING ESC

Observe the following procedures to safely power up your model after it has been bound. **Ensure propeller is removed unless sequence is followed to power up before flight.**

1. Lower the throttle stick and trim to their lowest setting and turn on the transmitter. Wait for your transmitter to indicate the RF signal is being broadcast before proceeding.

If a battery is connected to the ESC with the throttle fully open on the active transmitter, the ESC will enter into programming mode. If this occurs, simply disconnect the battery, lower the throttle, and reconnect the battery.

2. Ensure the rudder, elevator and aileron sticks are centered.
3. With the airplane on a solid surface, connect the battery to the ESC and wait. The ESC will emit a series of audible tones during its initialization process.
4. The ESC will emit a short, final tone sequence indicating that the ESC is now armed, and that the motor will spin in response to throttle stick movement.

! WARNING

When making adjustments to linkages, transmitter settings, or the Aura 8 flight control system, REMOVE THE PROPELLER to guard against accidental spool up.

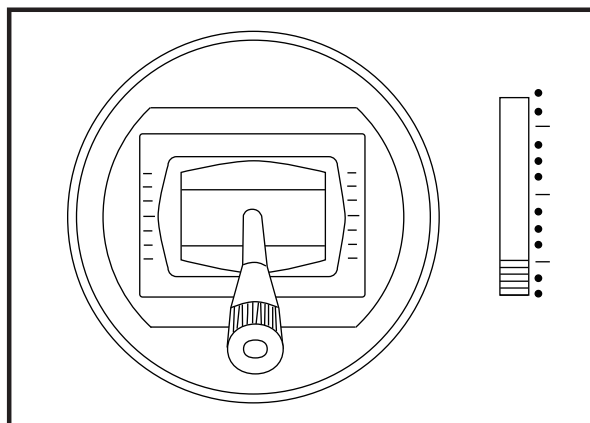

! CAUTION

Always connect the battery when the throttle and throttle trim are in the cut-off position.

! WARNING

Hold aircraft securely when connecting the flight battery before flight. Always ensure that the propeller is clear of any and all objects, as they may become entangled.

AURA 8 AFCS

The Aura 8 advanced flight control system installed in your Cessna 170 is a giant leap forward in aircraft flight control system technology. Compatible with virtually every receiver on the market today via PWM connections, the Aura features special configuration for DSM systems via remote receiver connection, and serial data connection for Futaba S.Bus, Spektrum SRXL, Graupner HOTT (Sum D of 8), JR XBus (Mode B), and Jeti UDI12 (standard) systems.

The Aura 8 advanced flight control system in your Cessna 170 has been pre-tuned for ease of use, eliminating many hours of setting gains. For the latest Aura features, programs, transmitter downloads, and instructions, please visit www.flexinnovations.com/aura

The Aura is programmable through any Windows based computer, and every axis has independent gain adjustment and by each flight mode. All dual rate, expo, travel, and assignable mode programs are adjusted inside the Aura through the PC application. An assignable master gain that is OFF by default can be enabled by the Aura application. If desired, assign it to CH 8/AUX 3 on a proportional dial or slider.

By default, CH5/Gear is used to select the 3 flight modes by 3 position transmitter switch.

- Works conveniently with all major radio systems
- Accepts signals from DSM Satellite(s), Spektrum SRXL, Futaba S.Bus, Graupner Hott (Sum D of 8), JR XBus (Mode B), Jeti UDI12 (standard), PPM Stream, or any brand of receiver via male to male servo connections*
- Expertly tuned and ready to use
- USB port allows loading model configurations, user programming, and firmware updates (cable included)
- Flexible and extensive programming through PC
- 3 flight modes in Aura allow precise or aggressive settings, or gyro off to be selected in flight
- 3-axis gyro utilized in Cessna 170 programming
- Powerful 32-bit processor and 6 axis sensor for future updates and re-use

*Visit <http://wiki.flexinnovations.com/wiki/Aura> for the latest Aura-related product information.

RECEIVER INSTALLATION/SERVO CONNECTIONS

Aura will Auto-Detect modern data-linked receivers. The advantage of using a modern data-linked receiver is the ability to have 4 additional gyro-enabled outputs to servos (total of 8 outputs), as well as wiring simplicity versus traditional PWM connection types. To connect a modern data-linked receiver, follow the steps on this page, then skip ahead to page 14.

For traditional PWM receivers (male to male servo leads for each channel), refer to the connection diagram on page 13.

Supported Modern Data-Linked Receivers

Aura will Auto-Detect these modern data-linked receivers:

Spektrum Remote Receivers (2 required for the Cessna)
Spektrum SRXL
Futaba S.Bus
JR XBus, Mode B
Graupner HOTT, Sum D of 8*
Jeti UDI12* (Standard)

You can also use a PPM (8ch, Negative, Approximately 22ms Frame) connection in Port B, but it will not auto-detect, and will need to be set in the Aura Config Tool (Windows Application)

Connecting Your Receiver to Aura

Spektrum Remote Receivers

1. Connect (2) Spektrum Remote Receivers to Mini Port 'A' and Mini Port 'B' at the top of the Aura case.
2. To bind a DSMX Spektrum Remote Receiver connection, insert a bind plug into Aura Port S8.

To bind a DSM2 Spektrum Remote Receiver connection, insert a bind plug into Aura port S1 AND S8.

Power up the model, and the remote receivers should begin to flash, indicating they are ready to bind. Bind from here as recommended in your transmitter manufacturer's instructions.

3. Once bound (indicated by each remote receiver showing a solid orange LED), Aura will begin the Auto-Detect process, searching for a valid control signal, indicated by sweeping LEDs on the Aura. Once found, you will see solid orange (power and calibrated sensor) and solid green (valid receiver data) LEDs, indicating the Aura is in its flight-ready state.
4. Mount your receivers using double sided foam tape, or hook and loop tape. Consult your receiver manual for proper mounting orientations.

All Other Data-Linked Receivers

1. For JR DMSS, Graupner Hott and Jeti, consult your radio documentation and program the transmitter/receiver to output the correct digital data format as listed above. (Spektrum and Futaba typically always output the digital data stream.
2. Bind your transmitter and receiver per your manufacturer's instructions.
3. Connect the included male to male extension to the receiver's data port (ex: S.Bus) and connect to servo port 'B' on the face of the Aura. Refer to your radio manufacturer's instructions for specific information on appropriate serial port connections and system settings.
4. With the transmitter powered, power up the aircraft. Aura will search (sweeping LEDs) and lock onto the signal. You will then see solid orange (power and calibrated sensor) plus solid green (valid radio source), and have control of the model.
5. Mount your receiver using double sided foam tape or hook and loop tape. Consult your receiver manual for proper mounting and antenna placement.

Note: When using S.Bus, Aura reverses the throttle direction. It is therefore NOT necessary for Futaba S.Bus users to reverse the throttle IF the throttle/ESC is left plugged into the Aura.

DEFAULT AURA CONNECTIONS

S1	Throttle (ESC/BEC)
S2	Left Aileron
S3	Right Aileron
S4	Elevator
S5	Rudder
S6	Left Flap
S7	Right Flap
S8	Float Rudder

Aura
Polarity + -

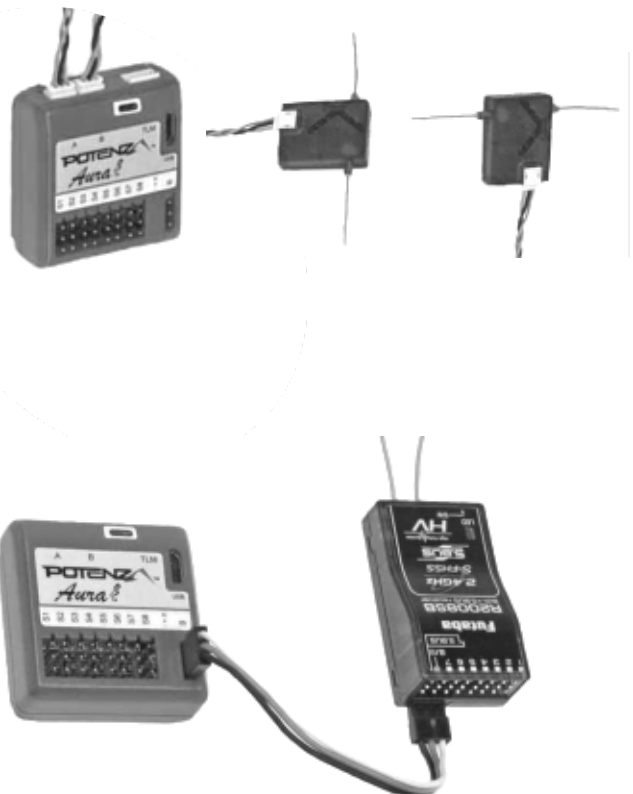

RECEIVER INSTALLATION/SERVO CONNECTIONS (CONTINUED)

PWM Connections

If you are using a digital receiver connection, and have completed the steps on page 12, skip ahead to the next page.

PWM is an acronym that stands for Pulse Width Modulation. PWM is how traditional receivers send a signal to the servo to command the servo move to a particular position. In short, PWM in regards to the Cessna requires the use of male to male servo extensions to connect each channel from your receiver, to each port in the Aura. Due to the flaps and the flight modes in the Aura, a minimum of a 6-channel receiver and transmitter is required to maximize the functionality of the Cessna 170. A 7+ channel receiver and transmitter is recommended.

Depending on your particular radio and PWM setup, some additional items to purchase are required:

- FPZAU01 Aura 3 piece male to male servo cable/S.Bus
- FPZA1011 *In-Line Servo Reverser (one for flaps)
- FPZA1012 *2-inch Y-Harness (one for flaps, two if using floats)

1. Bind your receiver to your transmitter by following the instructions included with your radio and/or receiver. Verify it is bound by connecting a spare servo to your receiver, and that it responds to transmitter inputs.
2. With the transmitter and receiver powered OFF, connect your receiver to the Aura using the diagram below. Note the throttle AND both flaps are plugged directly into the receiver. **Important: all four (4) PWM male-to-male leads must be properly connected for the Aura to activate servo outputs!**
3. With the propeller removed and ALL connections made between the Aura and the receiver (and in the proper polarity), power on your transmitter, and power on the airplane with the flight battery, and keep the airplane stationary. After a few seconds, the LEDs on the Aura will sweep back and forth as the Aura searches for a valid control signal. Once found, you will see a solid orange (Aura running) and solid green (Aura is receiving a valid signal from the receiver) LED. **After the source is found, apply transmitter right rudder to assist Aura in determining your radio type**, then you will have control of the model.

⚠ NOTICE

VERIFY PROPER POLARITY OF ALL CABLE CONNECTIONS PRIOR TO ADDING POWER TO THE SYSTEM

⚠ IMPORTANT

All four PWM male-to-male connections must be connected AND connected in the proper polarity for the Aura to activate servo outputs. (Aileron-S1, Elevator-S2, Rudder-S3, Gear/Ch.5-S4)

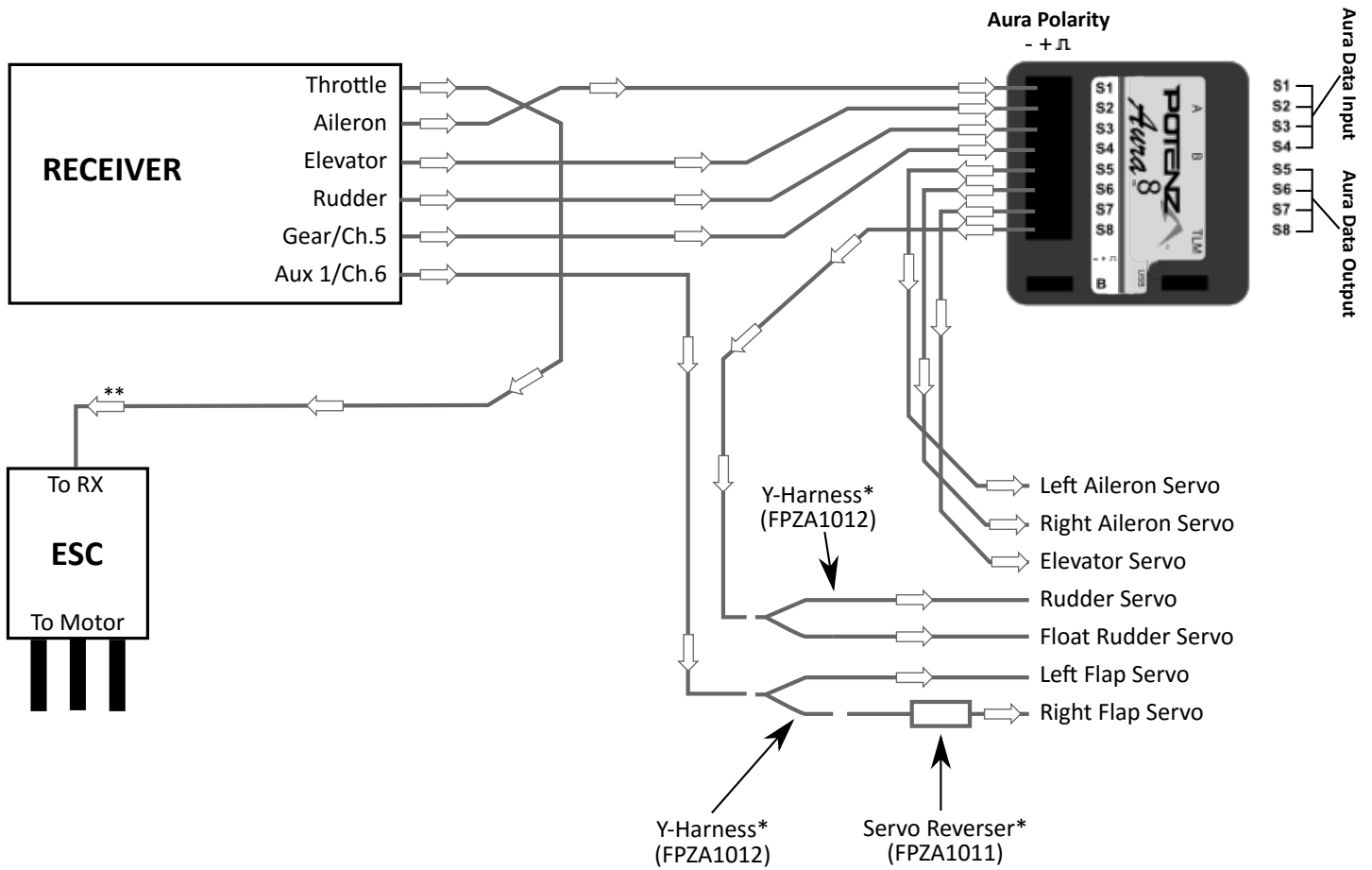

*Note: Y-Harness and Servo Reverser not required if using a 7+ channel receiver/transmitter with dual flap servo and independent reversing capability
 **Note: Arrows indicate signal (data) flow. They do not necessarily indicate voltage (+) flow.

TRANSMITTER CONTROL DIRECTION TEST

Refer to the chart below to determine the proper control surface directions. **If controls are reversed, DO NOT REVERSE CONTROLS IN TRANSMITTER OR IN THE AURA CONFIG TOOL. Email us at support@flexinnovations.com for corrective action. Note that BOTH the Transmitter Control Direction Test AND the Flight Controller Sensor Direction Test MUST BOTH BE PASSED! IF ONE DOES NOT PASS, DO NOT FLY!**

Note: There is pre-configured rudder to aileron and rudder to elevator mixing programmed into the Aura. If you see elevator or ailerons move with rudder stick input, this function is intentional and completely **NORMAL**.

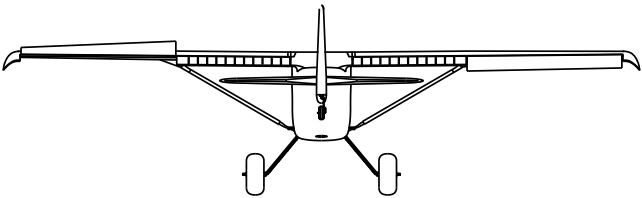
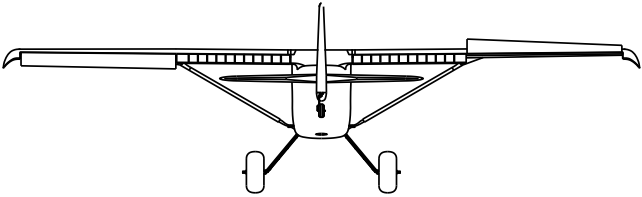
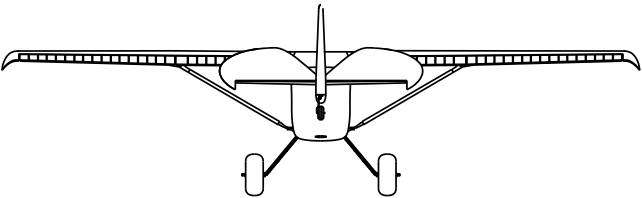
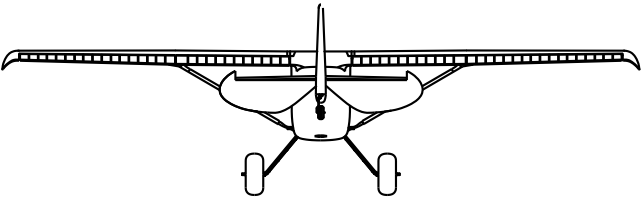
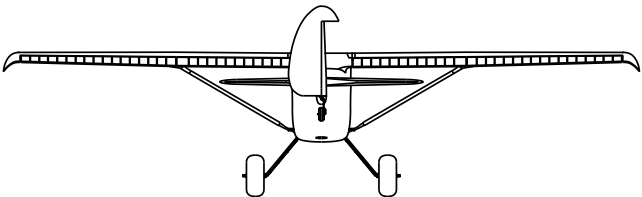
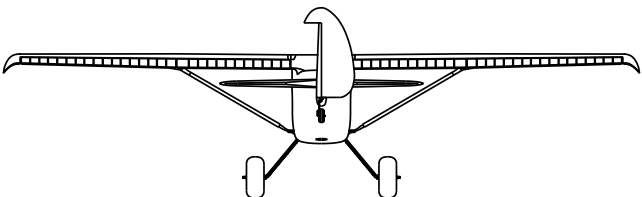
		Stick Movement	Proper Control Surface Deflection
AILERON	Stick Left		
	Stick Right		
ELEVATOR	Stick Aft		
	Stick Forward		
RUDDER	Stick Left		
	Stick Right		

FLIGHT CONTROLLER SENSOR DIRECTION TEST

Perform a test of the gyro system to verify the corrections made for a given movement are correct. If any of the tests do not result in the correct reaction from the airplane's gyro system, do not fly the airplane, and contact us via email at support@flexinnovations.com

The flight control system activates with RF broadcast. Perform these tests in Flight Mode 3 (highest gain) for better visibility and then in Flight Mode 2, and any other modes that have gyro gains assigned. (By default, Mode 1 has no gain assigned). Control surface deflections are exaggerated in the drawings below for clarity. Note that the control surfaces will only deflect while the model is rotating.

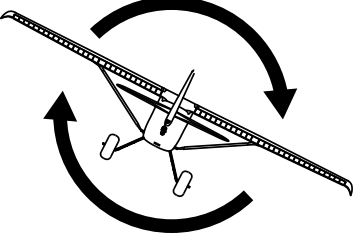
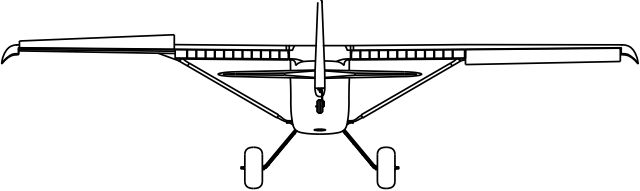
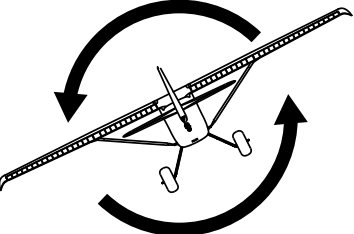
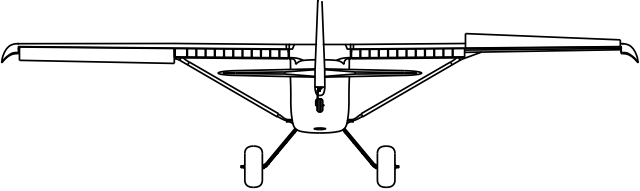
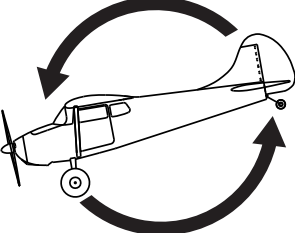
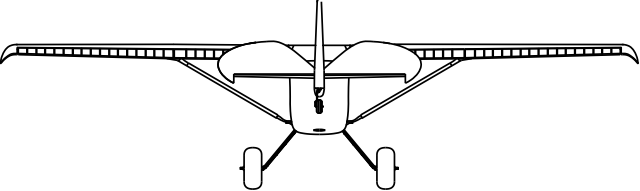
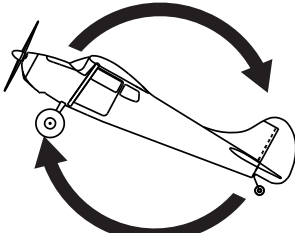
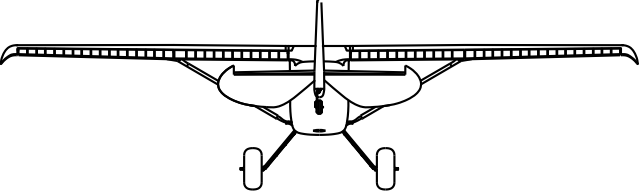
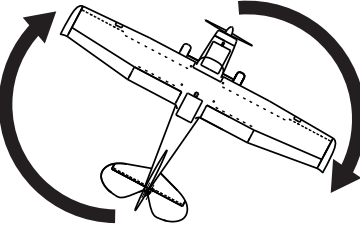
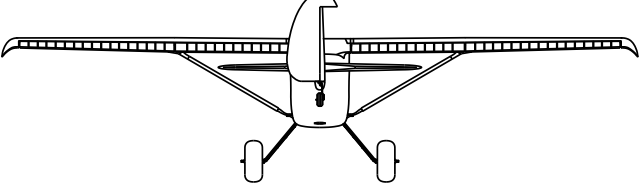
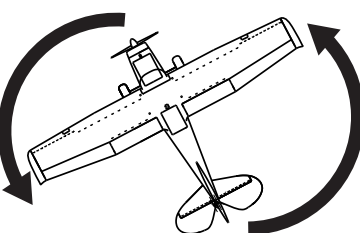
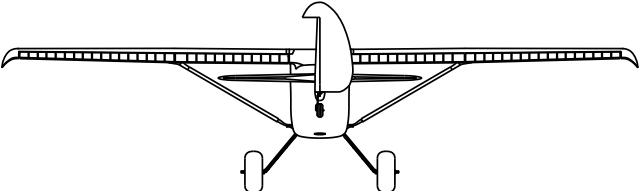
	Aircraft Movement	Proper Control Surface Deflection
AILERON		
		
ELEVATOR		
		
RUDDER		
		

BATTERY INSTALLATION

1. It is recommended to install adhesive-backed hook and loop tape strips to the battery and battery tray to help prevent the battery from coming loose in flight.
2. Pull the spring-loaded battery latch tab towards the nose of the airplane to release the battery hatch. Be sure to continue holding the latch. Using the tape on the front of the hatch, lift the hatch up, and towards the nose to remove it from the fuselage. Release the latch once the hatch is off of the fuselage.

4. Press the battery to the center of the battery tray and secure with the provided hook and loop straps. Depending on your battery selection, location may vary. Consult the center of gravity section at the bottom of this page in order to set the battery location for the proper center of gravity.
5. Reinstall the hatch in reverse order, and confirm that the latch has positively engaged.



⚠ CAUTION

Always keep limbs clear from the propeller when the battery is connected. After the ESC arms, the propeller will rotate when the throttle is moved. Unlike an internal combustion engine, electric motors apply more voltage to counteract resistance, therefore any object that is entangled in the propeller will be severely damaged before the motor will stop.

⚠ WARNING

When making adjustments to linkages, transmitter settings, or the Aura 8 flight control system, remove the propeller to guard against accidental spool up.

CENTER OF GRAVITY

The location of the center of gravity (CG) for the Cessna 170 is 90mm (3-1/2-inches) AFT of the leading edge of the wing at the wing root, plus or minus 7mm (1/4-inch). This measurement was determined from many test flights by designer and many time world aerobatic champion, Quique Somenzini. Lift the airplane from the underside of the wing to check the CG. Be sure to keep the model level while measuring CG (model should be in its flying position, where the bottom of the airfoil is level).

Setting the center of gravity is one of the most important steps for success, particularly with a new airplane. The Cessna is a versatile airplane, with many different battery options, large throws, and a high thrust to weight ratio. These factors make it a very enjoyable aircraft to fly, but if the center of gravity is not within an acceptable range, it will make the airplane difficult, if not impossible, to control.

⚠ NOTICE

The CG measurement should be made with the completed airframe, with all components (batteries, servos, receiver, linkages, screws, bolts, hardware, etc.) installed. Failure to do so will result in inaccurate measurement.

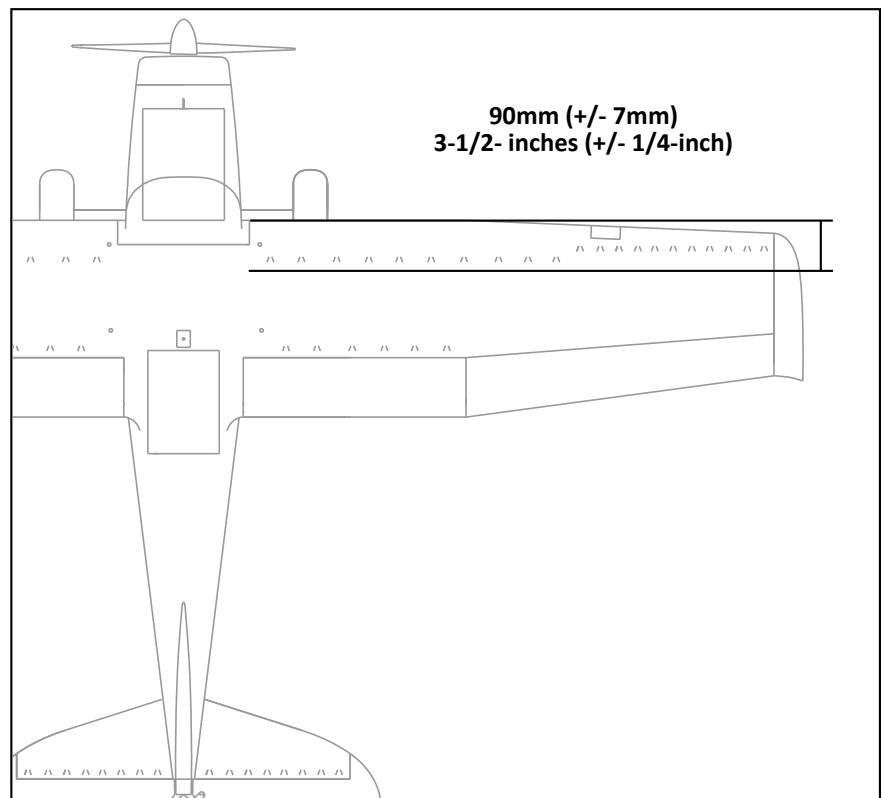

FLYING YOUR CESSNA 170

Selecting a Flying Site

Selecting a flying site is critical to a successful flight. Airplanes require a lot more room than other R/C products, therefore, a neighborhood or parking lot is not recommended. A local AMA field is the best location for flying your Cessna 170. If no AMA field is available in your area, a large open field with short grass and generous overfly area is the best candidate. Know your overfly area. Ensure that there are no houses, playgrounds, people or other buildings that may be damaged if the airplane were to crash.



Takeoff

Taxi or place the aircraft on the runway centerline, with the nose pointed into the wind. Select Flight Mode 2, with the flaps in the up position for the first flight. Set throttle trim so that the motor spins at it's lowest RPM without stopping. Smoothly advance the throttle to full while maintaining directional control with the rudder and slight back pressure on the elevator. The airplane should lift off smoothly before the throttle is fully open. Fly in Flight Mode 2 until the aircraft is fully trimmed (see special trimming instructions), and you are comfortable with it's handling, then explore the other modes as desired.

Flying

Altitude is your friend on the first flight. Briskly climb to a safe altitude and trim the airplane. The airplane should fly straight and level at 2/3 power (depending on battery pack voltage selection), with no input from the sticks. Try some basic maneuvers, and slowly progress into the airplane's flight envelope as you become more comfortable with the airplane's flight qualities and perfect your setup. **Note: if at any time, such as after gain adjustments, you experience unexpected control system inputs or oscillations, switch to Mode 1, and land and troubleshoot the issue. (Mode 1 turns the sensor inputs off with default programming)**

Landing

Be mindful of your flight time and allow adequate battery reserve for a couple of landing attempts, if necessary, on the first few flights. For the first few landings, land with the flaps in the up position. Select Flight Mode 2 and slow the airplane and align with the runway, into the wind. The airplane should descend smoothly in this configuration with proper airspeed. Once you are close to the ground, gradually close the throttle fully and begin to smoothly apply up elevator as required to arrest descent and the airplane should gently touch down with a short roll out.

USE CAUTION WHEN FLYING YOUR CESSNA 170 IN FLIGHT MODE 3 AT HIGH AIRSPEEDS. DOING SO CAN INDUCE CONTROL SURFACE OSCILLATIONS AND MAY CAUSE A CRASH.

Trimming

The first several flights on your Cessna 170 should be dedicated to trimming and setup. Fly the airplane at 2/3 power in **Flight Mode 2** and trim for level flight. Land, adjust linkages and return the trim to zero, and fly again. Repeat until the airplane flies hands off, straight and level. Transmitter trim or sub-trim will cause trim shifts when different flight modes are selected. To eliminate this trim shift, you can mechanically trim the model, or you can complete and Aura "Quick Trim".

Aura Quick Trim

The Aura 8 features a Quick Trim Mode that eliminates the need for mechanical linkage adjustments during test flights. Aura will learn the trim values from your transmitter, and apply them to the control surfaces at power up when enabling quick trim mode.

NOTE: Quick Trim can also be used BEFORE flying to make small changes to center the control surfaces before flight.

1. Fly the airplane in Flight Mode 2. Trim the aircraft with the transmitter and land. **DO NOT CHANGE FLIGHT MODES.**
2. Power off the Aura. Insert a bind plug into **Aura Port S3** (you will need to remove the servo lead that is currently in S3). Check the transmitter is on and repower the Aura.
3. Wait 5 seconds for the Aura to completely initialize. Confirm Quick Trim mode is active by checking the Blue LED is slowly flashing.
4. Remove the bind plug from Aura Port S3, and re-install the servo that was previously removed into S3. Removing the bind plug stores the current trims in the Aura. The Blue LED will flash quickly after control surface trim values are store. While the trim values are stored in Aura, they are not applied to the control surface(s) until the Aura is repowered.
5. Remove power from the Aura and center all control surface trims on the transmitter.
6. Repower the Aura. The control surfaces should be unchanged even though the trim has been centered on the Transmitter. Switch between other Flight Modes to ensure you do not see any changes in trim.

NOTE: QUICK TRIM MAY BE REPEATED AS NEEDED FOR FINE TUNING, OR IF CHANGES TO THE AIRCRAFT ARE MADE.

NOTE: ENSURE AILERON/ELEVATOR/RUDDER SUB-TRIMS ARE ZERO BEFORE FLYING FOR QUICK TRIM PROCESS

NOTE: QUICK TRIM IS NOT AVAILABLE TO PWM CONNECTION USERS. IF USING A PWM CONNECTION TYPE, YOU WILL NEED TO MECHANICALLY TRIM THE MODEL

LEARNING TO USE FLAPS WITH THE CESSNA 170

The Cessna 170 was designed from the ground up to be the most versatile and fun-flying aircraft possible. Pilot workload has been greatly reduced thanks to its finely tuned aerodynamic design, and the pre-set configuration of the Aura 8 Advanced Flight Control System. Pilots of all skill levels will quickly find the Cessna 170 is a forgiving airplane, in many different attitudes and flight regimes.

Sharpening Your Skills & Understanding How Flaps Work

Obviously, before attempting to fly with flaps, you should be proficient at flying an airplane, and be comfortable flying the Cessna 170 in various attitudes.

As a short aerodynamics explanation, flaps essentially change the airfoil or cross-section shape of the wing, and have two primary goals or functions depending on the model. One, to add lift (by changing the airfoil shape) and two, to increase drag. A high-lift airfoil is typically flat bottom, or undercambered (bottom wing profile curves in similar direction to the top profile). By adding flap deflection, the wing transforms into a partially undercambered airfoil, generating more lift, and more drag as a by-product. Due to this addition of lift, variances in airspeed can cause pitch changes in the aircraft when the flaps are deployed. Typically with a high wing model like the Cessna 170, the addition of flap input will cause a pitching-up moment, as the model is not "trimmed" for that amount of lift at that particular speed. To combat this, many experienced pilots will use "flight mode trims" that change elevator trim with flap position, or a flap to elevator mix, so that this pitching up moment is automatically compensated for. Note that it is virtually impossible to eliminate this pitching moment at all airspeeds, but can be compensated for in the most common airspeeds the pilot will use the flaps. Quique's flap to elevator mixing recommendations are in the chart to the right for your reference.

It is important to understand that this pitching moment when the flaps are deployed is **normal**. It is also normal for this pitching moment to vary, depending on airspeed.

ADVANCED "3D" CESSNA SETUP

The Cessna comes with additional flap pushrods that are longer than the stock (installed) pushrods. This allows the flaps to travel in both the up and down position, much like ailerons. With this capability, you can mix the flaps with the ailerons and have much greater aileron authority in slow speed "high-alpha" flight, and also mix in "crow" or speed brake functionality as well. Also, the flaps are in the roll axis gyro loop, which allows them to correct along with the ailerons for changes in roll. This adds extra stability at slow speeds, including landing, and 3D flight.

Should you choose to install these pushrods, you will need to re-program the Aura 8. A new Aura Config file pre-programmed for this advanced setup is located on the Aura Wiki page. To install, download the Aura 8 Config Tool, and download the Advanced Cessna Setup. Follow the directions on the wiki page to program the Aura 8 with this config file. Both the config file, and Aura Config Tool can be found here:

<http://wiki.flexinnovations.com/wiki/Cessna170>

It is important to note that this advanced setup is not compatible with PWM Aura connection types. If you still want similar capability with a PWM setup, mixing in your transmitter is required. Consult your transmitter manufacturer or manufacturer's manual for further assistance.

Reference the information below for a basic understanding of each Flight Mode with the Advanced Cessna setup.

Flight Mode 1 - Crow

Low dual rate aileron, high dual rate elevator/rudder
Low gyro sensitivity for aileron, high gyro sensitivity for elevator/rudder
Rudder to aileron mix and rudder to elevator mix is OFF
Crow" with ailerons up, and flaps down. Mixed to throttle so that crow is removed as throttle is advanced.
Throttle to elevator mix to compensate for crow effects
Flaps are in the roll axis gyro loop
Aileron differential set with Aura

Flight Mode 2 - Sport Aerobatics

Low dual rates on all surfaces
Low gyro sensitivity on all surfaces
Standard flap function
Rudder to aileron mix and rudder to elevator mix is ON
Flaps are NOT in the roll axis gyro loop
Aileron differential set with Aura

Flight Mode 3 - 3D Aerobatics

3D dual rates on all surfaces
High gyro sensitivity
Flaps mixed to work with ailerons in roll
Rudder to aileron and rudder to elevator mix is ON
Flaps are in the roll axis gyro loop
Aileron differential set with Aura

Flap Deflection	Mix %
1-9/16-inches (40mm) Flap Deflection	15% Down Elevator
2-3/4-inches (70mm) Flap Deflection	24% Down Elevator

First Flights with Flaps

For first flights, it is recommended to have two flap positions, a half flap setting, and a full flap setting. It is also helpful to have the flap speed slowed to about 1.5 seconds. As with learning anything new, altitude is your friend. Start at a safe altitude, several mistakes high, and begin to slow the model down. It is best if you move the throttle to the off or idle position, and let the airplane stabilize in a slight descent. Once the model has stabilized at a slow airspeed and slow decent, move the flap switch to the half flap position. Note that the model may pitch up slightly, but quickly will stabilize into a shallow descent again. Once the aircraft has stabilized in the half flap position, move the flap switch to the full position, noting that the model may pitch up once again. Full flap, depending on airspeed, may require a small amount of down elevator pressure to keep it from pitching up. Note that the higher the airspeed, the more the model will pitch up when flaps are applied. It is always best to deploy the flaps at slower airspeeds until you are comfortable with how the model acts when the flaps are deployed.

As you become more comfortable with the flaps, you'll soon realize how much they aid in short-field takeoffs and landings!

My Cessna Rolls When I Deploy Flaps!

This is typically caused by flap travels that are not traveling the same amount. This can be fixed by adjusting flap linkage length, and/or servo arm position on the spline of the servo. Consult our Cessna wiki page for more detailed information:

<http://wiki.flexinnovations.com/wiki/Cessna170>

AIRFRAME REPAIRS

The Cessna 170 is molded from durable EPO foam and is repairable with most adhesives. Similar to building and repairing wood or composite airplanes, the correct glue for a given application is critical to the repair holding and not breaking again. For major repairs, such as a broken fuselage, epoxy is preferred because it allows time to correct any misalignment. For smaller repairs, such as a cracked control surface or small chunk of material missing from the airframe, regular CA is very effective. The use of odorless (foam safe) CA is not recommended on EPO foam aircraft because it is weaker than regular CA and takes a longer period of time to cure and the bond tends to be weaker.

NOTE: Avoid the use of CA accelerant in repairs. It can damage paint and will weaken the bond of the glue. If CA accelerant is used, be mindful of the locations of CA to prevent premature bonding of parts, or bonding a hand or clamp to the airframe.

If a part is damaged too badly to be repaired, please refer to the back of the manual for a complete listing of spare airframe parts.

NOTICE: If a crash is imminent, fully reduce the throttle to prevent further damage to the power system and reduce energy to lessen impact damage. Never allow the propeller to contact the ground under power, even idle.

BE ADVISED THAT CRASH DAMAGE IS NOT COVERED UNDER ANY PRODUCT WARRANTY.

Avoid keeping the airplane in direct sunlight or in hot vehicles when not flying. Excessive heat can damage the airplane's structure and UV damage can permanently discolor decals.

REPLACING SERVOS

Required Tools and Fasteners: #1 Phillips Screwdriver

1. Unplug the servo from the receiver or any extension.
2. Unscrew the servo arm from the servo and remove the servo arm.
3. Unscrew the two mounting screws located at each end of the servo and remove. Note that the aileron servos are connected to the navigation lights with a Y-harness. The wires are also taped to the inner wing skin, and may require a firm pull to remove.

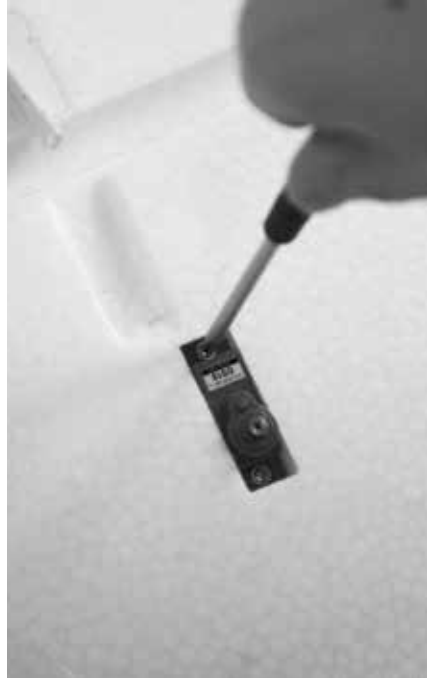

Tip: Plug a spare extension lead into the servo when removing to make it easier to install the lead of the servo when replaced.

SERVICING THE POWER SYSTEM

Required Tools and Fasteners: #1 Phillips Screwdriver, Adjustable Wrench

1. Remove the propeller and spinner assembly from the motor. Follow the assembly instructions on page 6 in reverse.
2. Remove the cowling by unscrewing the M3x10 phillips self-tapping screws from the firewall. You will need a long enough screwdriver to reach through the grill of the cowling.
3. Gently remove the cowling from the fuselage, being sure not to lose the two M3x10 screws.
4. Remove the (4) bolts holding the motor to the firewall using a #1 Phillips screwdriver. Disconnect the motor from the ESC.
5. To remove the ESC, simply unplug its lead from the receiver or Aura and the output leads from the motor.

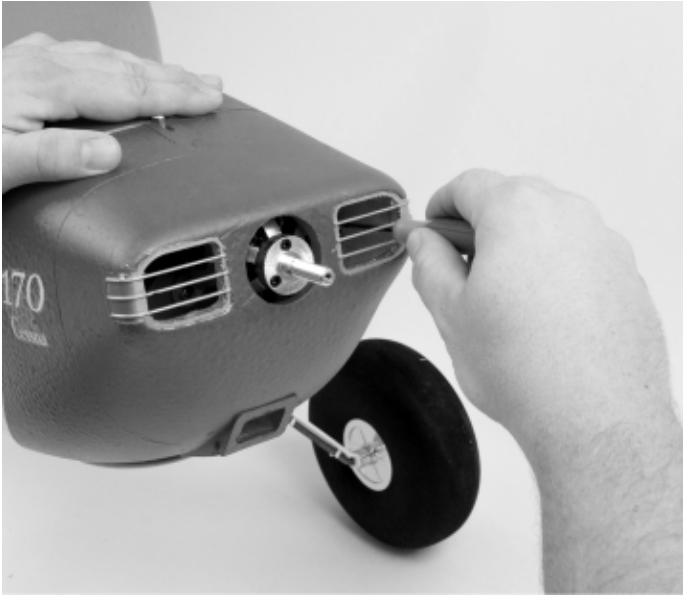

AIRCRAFT TROUBLESHOOTING GUIDE

Should you encounter any abnormal situations with your Cessna 170, refer to the matrix below to determine probable cause and a recommended solution for the action.

If the required solution does not rectify the problem, please contact product support for further assistance.



NOTICE

Unless specifically required, ALWAYS troubleshoot the airplane with the propeller removed.

DISCREPANCY	PROBABLE CAUSE	RECOMMENDED SOLUTION
Motor nonresponsive (ESC initialization tones audible)	Throttle not at idle and/or throttle trim too high	Lower throttle stick and trim completely. If problem persists, ensure that the sub-trim and travel adjust are properly set in the radio's programming.
	Throttle channel is reversed	Reverse throttle channel in radio programming
Motor nonresponsive (No ESC initialization tones audible)	Motor disconnected from ESC	Ensure plugs are fully seated. Check battery and/or plugs for damage and replace any damaged components found. DO NOT ATTEMPT TO REPAIR
Motor turns in the wrong direction	The three motor wires are connected incorrectly to the ESC	Swap any TWO motor wires.
Reduced flight time or aircraft under powered	Flight battery not fully charged	Ensure battery is fully charged prior to installing in aircraft.
	Propeller installed backwards	Install propeller so that the convex side faces forward (tractor configuration)
	Flight battery damaged	Remove battery from service completely and replace with a different battery
	Ambient temperature is too cold	Ensure battery packs are adequately warm (70F/21C) before flight
	Battery capacity too small for intended use.	Replace battery with one of proper capacity and discharge capacity (C rating)
	ESC reaching preset LVC (low-voltage cutoff)	Recharge flight battery or reduce flight time
	Battery is too weak or damaged	Check battery's physical condition, check battery voltages after charge
Excessive propeller noise and/or vibration	Battery's discharge rating may be too small	Replace battery with one with higher 'C' rating
	Damaged spinner and/or propeller, collet, or motor	Replace damaged components - DO NOT ATTEMPT REPAIR
	Propeller is not balanced	Balance or replace the propeller
	Prop nut is loose	Tighten prop nut with appropriate-sized wrench
Control surfaces nonresponsive	Spinner is not fully in place or tightened	Loosen the spinner bolt, adjust as required, retighten spinner bolt
	Propeller nut or propeller adapter threads not cut straight	Replace propeller nut or propeller shaft - DO NOT ATTEMPT REPAIR
	Airframe or control linkage system damaged	Examine airframe for damage, repair as required, inspect control linkage system (servo, pushrod, control horn) for damaged components and replace as required
	Wire damaged or connector loose	Examine wires and connections, replace as necessary
	Transmitter bound incorrectly, incorrect active model memory, incorrect Aura data input configuration, incorrect Aura transmitter settings	Consult radio manual for proper binding and model selection instructions
	Battery voltage too low	Use volt meter to check battery; recharge or replace as necessary
	Battery disconnected from ESC	Check that the EC5 plugs are fully seated
BEC (battery eliminator circuit) damaged	Replace ESC - DO NOT ATTEMPT REPAIR	
Damaged Servo	Replace Servo - DO NOT ATTEMPT REPAIR	
Failed control direction test	Incorrect Aura 8 or Transmitter setting - DO NOT FLY!	Reference transmitter and receiver sections of this manual. If no solution found, contact customer support at support@flexinnovations.com
Controls Reversed	Aura 8 or transmitter settings incorrect	Refer to control surface direction chart and transmitter setup; adjust appropriate settings as required. Check Cessna and Aura wiki web pages for additional information. Contact support
Control surface oscillation	Exceeding maximum airspeed for configuration	Reduce airspeed
	Gains too high for aircraft/flight configuration	Refer to Aura 8 manual to decrease desired control surface gain
	Propeller/spinner not balanced	Balance or replace propeller and/or spinner
	Motor vibration	Inspect motor mounting bolts and re-tighten as necessary
	Loose Aura 8 mounting	Re-align and secure the Aura 8 to the aircraft
	Control linkage slop	Examine control system and repair or replace work components
	Improper transmitter setup	Refer to Aura 8 manual to correctly configure transmitter
	Damaged propeller or spinner	Replace damaged component - DO NOT ATTEMPT REPAIR
Improperly Set Master Gain	Ensure Master Gain channel is set for proper gain value	
Trim changes between flight modes	Trims are not properly zeroed	Readjust control linkage and re-center trims in radio
	Sub-trim is not properly zeroed	Remove sub-trim; adjust the servo arm or clevis to achieve proper geometry
	Transmitter is not properly calibrated (Ail, Ele, Rud are not zero/center with sticks centered; reference transmitter monitor)	Calibrate transmitter (reference your manufacturer's instructions, or send to manufacturer to have calibrated)

AIRCRAFT TROUBLESHOOTING GUIDE (CONTINUED)



NOTICE

Unless specifically required, ALWAYS troubleshoot the airplane with the propeller removed.

DISCREPANCY	PROBABLE CAUSE	RECOMMENDED SOLUTION
PWM Connection type and cannot get Orange+Green Aura LED and Control of Model	Any of four PWM servo cables not connected	Connect all four male to male servo cables between your receiver and Aura
	PWM Servo cables connected to incorrect ports	Re-connect cables to proper ports. Reference chart on page 11
	Polarity of PWM Servo cables not correct	Remove servo cables and connect with proper polarity (reference page 11)
	Receiver not bound and/or outputting PWM servo pulses	Bind your receiver per your manufacturer's instructions, and use a servo ensure it is outputting PWM signal from all four channels required
Airplane Rolls when flaps are in the down position	Left and right flap travels are not equal	Adjust servo arm location on spline and/or flap pushrod length to match throws. Reference Cessna 170 wiki page for more information: http://www.wiki.flexinnovations.com/Cessna170

REPLACEMENT PARTS

FPM3170	Cessna 170 Super PNP
FPM3180	Cessna 170 Super PNP Night
FPM317001	Cessna 170: Fuselage
FPM318001	Cessna 170: Fuselage with LED
FPM317002	Cessna 170: Wing Set
FPM318002	Cessna 170: Wing Set with LED
FPM317003	Cessna 170: Tail Set
FPM317004	Cessna 170: Hatch Set/Cowling
FPM317005	Cessna 170: Landing Gear Set
FPM317006	Cessna 170: Main Wheel Set
FPM317007	Cessna 170: Tube Joiner Set
FPM317008	Cessna 170: Wing Strut Set
FPM317009	Cessna 170: Pushrod Set
FPM317010	Cessna 170: Hardware Set
FPM317011	Cessna 170: Red/Silver Decal Set
FPM317012	Cessna 170: Spinner
FPMP1606E	SR Propeller 16x6E
FPZDS33	Potenza DS33 MG Digital Mini Servo
FPZDS19	Potenza DS19 MG Digital Sub-Micro Servo
FPZDS19F	Potenza DS19 MG Digital Sub-Micro Servo Float
FPZM1060L	Potenza 60 Light 540Kv Brushless Motor
FTVHWBQ8012EB	Hobby Wing 80A Skywalker ESC w/External 5V-8A SBEC
FPZM1060L2	Potenza 60L Motor X-Mount w/Screws
FPZM1060L1	Potenza 60L Motor Bolt-On Adapter
FPZM1060L3	Potenza 60L Motor Shaft w/Collar
FPZAURA08ZZC17	Potenza Aura 8 for Cessna 170
FPZA1014	Potenza LED Controller Cessna 170



OPTIONAL ACCESSORIES

FPM317014	Cessna 170: Float Set & Struts w/ LED Light
FPM317015	Cessna 170: Leading Edge Fixed Slat Set
FPM317016	Cessna 170: Snow Ski Set
FPM317017	Cessna 170: Glider Tow Pushrod
FPM317018	Cessna 170: Key Chain Camera Mount
FPZA1011	Potenza Single Line Servo Reverser
FPZA1012	Potenza 2 in. Servo Y Harness
FPZB40006S40	Potenza 6S 4000mAh 40C Li-Po Battery
FPZB50006S40	Potenza 6S 5000mAh 40C Li-Po Battery
FPZB50006S60	Potenza 6S 5000mAh 60C Li-Po Battery
FPZB50005S40	Potenza 5S 5000mAh 40C Li-Po Battery
FPZB50004S40	Potenza 4S 5000mAh 40C Li-Po Battery
FPZC80	C80 Multi-Chemistry Touch Screen AC/DC Charger
FTVHWBQ2006	Hobbywing ESC Programming Card
FPZA1010	Multi-Function Digital Battery Analyzer
FPZA1013	Potenza LED Controller QQ Extra 300



For the latest information regarding replacement parts, and all optional accessories, please visit the Cessna 170 product page at:

www.flexinnovations.com

LIMITED WARRANTY

Warranty Coverage

Flex Innovations, Inc. and its authorized resellers ("Flex") warrant to the original purchaser that the product purchased (the "Product") it will be free from defects in materials and workmanship at the date of purchase.

Outside of Coverage

This warranty is not transferable and does not cover:

- (a) Products with more than 45 days after purchased date.
- (b) Damage due to acts of God, accident, misuse, abuse, negligence, commercial use, or due to improper use, installation, operation or maintenance
- (c) Modification of or to any part of the Product.
- (d) Product not compliant with applicable technical regulations.
- (e) Shipping damage
- (f) Cosmetic damage

OTHER THAN THE EXPRESS WARRANTY ABOVE, FLEX MAKES NO OTHER WARRANTY OR REPRESENTATION, AND HERBY DISCLAIMS ANY AND ALL IMPLIED WARRANTIES, INCLUDING, WITHOUT LIMITATION, THE IMPLIED WARRANTIES OF NONINFRINGEMENT, MERCHANTABILITY AND FITNESS FOR A PARTICULAR PURPOSE. THE PURCHASER ACKNOWLEDGES THAT THEY ALONE HAVE DETERMINED THAT THE PRODUCT WILL SUITABLY MEET THE REQUIREMENTS OF THE PURCHASER'S INTENDED USE.

Purchaser's Solution

Flex's sole obligation and purchaser's sole and exclusive remedy shall be that Flex will, at its option, either (i) service, or (ii) replace, any Product determined by Flex to be defective. Flex reserves the right to inspect any and all Product(s) involved in a warranty claim. Service or replacement decisions are at the sole discretion of Flex. Proof of purchase is required for all warranty claims. **SERVICE OR REPLACEMENT AS PROVIDED UNDER THIS WARRANTY IS THE PURCHASER'S SOLE AND EXCLUSIVE REMEDY.**

Limitation of Liability

FLEX SHALL NOT BE LIABLE FOR SPECIAL, INDIRECT, INCIDENTAL OR CONSEQUENTIAL DAMAGES, LOSS OF PROFITS OR PRODUCTION OR COMMERCIAL LOSS IN ANY WAY, REGARDLESS OF WHETHER SUCH CLAIM IS BASED IN CONTRACT, WARRANTY, TORT, NEGLIGENCE, STRICT LIABILITY OR ANY OTHER THEORY OF LIABILITY, EVEN IF FLEX HAS BEEN ADVISED OF THE POSSIBILITY OF SUCH DAMAGES.

Further, in no event shall the liability of Flex exceed the individual price of the Product on which liability is asserted. As Flex has no control over use, setup, assembly, modification or misuse, no liability shall be assumed nor accepted for any resulting damage or injury. By the act of use, setup or assembly, the user accepts all resulting liability. If you as the purchaser or user are not prepared to accept the liability associated with the use of the Product, purchaser is advised to return the Product immediately in new and unused condition to the place of purchase.

Law

these terms are governed by Florida law (without regard to conflict of law principals). This warranty gives you specific legal rights, and you may also have other rights which vary from state to state. **FLEX RESERVES THE RIGHT TO MODIFY THIS WARRANTY AT ANY TIME WITHOUT PRIOR NOTICE.**

Questions & Assistance

Visit www.flexinnovations.com/articles.asp?ID=269 to find customer support in your region.

Inspection or Services

If this Product needs to be inspected or serviced and is compliant in the region you live and use the Product in, please contact your regional Flex authorized reseller. Pack the Product securely using a shipping carton. Please note that original boxes needs to be included, but are not designed to withstand the regors of shipping without additional protection. Ship via a carrier that provides tracking and insurance for lost or damaged parcels, as Flex is not responsible for merchandise until it arrives and is accepted at our facility.

Warranty Requirements

For Warranty consideration, you must include your original sales receipt verifying the proof of purchase date. Provided warranty conditions have been met, your Product will be replaced free of charge. Shipping charges are as follow: to Flex by customer, Flex out is by Flex. Service or replacement decisions are at the sole discretion of Flex.

COMPLIANCE INFORMATION FOR THE EUROPEAN UNION



Declaration of Conformity (In accordance with ISO/IEC 17050-1)

Product(s): Cessna 170 Super PNP
Cessna170 Super PNP Night
Item Number(s): FPM3170
FPM3180

The object of declaration described above is in conformity with the requirements of the specifications listed below, following the provisions of the EMC Directive 2004/108/EC.

EN 55022: 2010+AC:2011
EN 55024: 2010
EN 61000-3-2: 2006+A2:2009
EN 61000-3-3: 2013

EN 61000-6-3: 2007/A1:2011
EN 61000-6-1: 2007



Instructions for disposal of WEEE by users in the European Union

This product must not be disposed of with other waste. Instead, it is the user's responsibility to dispose of their waste equipment by handing it over to a designated collections point for the recycling of waste and electronic equipment. The separate collection and recycling of your waste equipment at the time of disposal will help to conserve natural resources and ensure that it is recycled in a manner that protects human health and the environment. For more information about where to drop off your waste equipment for recycling, please contact your local city office, your household waste disposal service or where you purchased this product.



Academy of Model Aeronautics National Model Aircraft Safety Code

Effective January 1, 2015

- A. **GENERAL:** A model aircraft is a non-human-carrying aircraft capable of sustained flight in the atmosphere. It may not exceed limitations of this code and is intended exclusively for sport, recreation, education and/or competition. All model flights must be conducted in accordance with this safety code and any additional rules specific to the flying site.
- Model aircraft will not be flown:
 - In a careless or reckless manner.
 - At a location where model aircraft activities are prohibited.
 - Model aircraft pilots will:
 - Yield the right of way to all human-carrying aircraft.
 - See and avoid all aircraft and a spotter must be used when appropriate. (AMA Document #540-D.)
 - Not fly higher than approximately 400 feet above ground level within three (3) miles of an airport without notifying the airport operator.
 - Not interfere with operations and traffic patterns at any airport, heliport or seaplane base except where there is a mixed use agreement.
 - Not exceed a takeoff weight, including fuel, of 55 pounds unless in compliance with the AMA Large Model Airplane program. (AMA Document 520-A.)
 - Ensure the aircraft is identified with the name and address or AMA number of the owner on the inside of affixed to the outside of the model aircraft. (This does not apply to model aircraft flown indoors.)
 - Not operate aircraft with metal-blade propellers or with gaseous boosts except for helicopters operated under the provisions of AMA Document #555.
 - Not operate model aircraft while under the influence of alcohol or while using any drug that could adversely affect the pilot's ability to safely control the model.
 - Not operate model aircraft carrying pyrotechnic devices that explode or burn, or any device which propels a projectile or drops any object that creates hazard to persons or property.
- Exceptions:**
- Free Flight fuses or devices that burn producing smoke and are securely attached to the model aircraft during flight.
 - Rocket motors (using solid propellant) up to a G-series size may be used provided they remain attached to the model during flight. Model rockets may be flown in accordance with the National Model Rocketry Safety Code but may not be launched from model aircraft.
 - Officially designated AMA Air Show Teams (AST) are authorized to use devices and practices as defined within the Team AMA Program Document. (AMA Document #718.)
 - Not operate a turbine-powered aircraft, unless in compliance with the AMA turbine regulations. (AMA Document #510-A.)
- Model aircraft will not be flown in AMA sanctioned events, air shows or model demonstrations unless:
 - The aircraft, control system and pilot skills have successfully demonstrated all maneuvers intended or anticipated prior to the specific event.
 - An inexperienced pilot is assisted by an experienced pilot.
 - When and where required by rule, helmets must be properly worn and fastened. They must be OSHA, DOT, ANSI, SNELL or NOCSAE approved or comply with comparable standards.
- B. RADIO CONTROL (RC)**
- All pilots shall avoid flying directly over unprotected people, vessels, vehicles or structures and shall avoid endangerment of life and property of others.
 - A successful radio equipment ground-range check in accordance with manufacturer's recommendations will be completed before the first flight of a new or repaired model aircraft.
At all flying sites a safety line(s) must be established in front of which all flying takes place. (AMA Document #706.)
 - Only personnel associated with flying the model aircraft are allowed at or in front of the safety line.
 - At air shows or demonstrations, a straight safety line must be established.
 - An area away from the safety line must be maintained for spectators.
 - Intentional flying behind the safety line is prohibited.
- RC model aircraft must use the radio-control frequencies currently allowed by the Federal Communications Commission (FCC). Only individuals properly licensed by the FCC are authorized to operate equipment on Amateur Band frequencies.
 - RC model aircraft will not knowingly operate within three (3) miles of any pre-existing flying site without a frequency-management agreement. (AMA Documents #922 and #923)
 - With the exception of events flown under official AMA Competition Regulations, excluding takeoff and landing, no powered model may be flown outdoors closer than 25 feet to any individual, except for the pilot and the pilot's helper(s) located at the flightline.
 - Under no circumstances may a pilot or other person touch an outdoor model aircraft in flight while it is still under power, except to divert it from striking an individual.
 - RC night flying requires a lighting system providing the pilot with a clear view of the model's attitude and orientation at all times. Hand-held illumination systems are inadequate for night flying operations.
 - The pilot of an RC model aircraft shall:
 - Maintain control during the entire flight, maintaining visual contact without enhancement other than by corrective lenses prescribed for the pilot.
 - Fly using the assistance of a camera or First-Person-View (FPV) only in accordance with the procedures outlined in AMA Document #550. Fly using the assistance of autopilot or stabilization system only in accordance with the procedures outlined in AMA Document #560
- C. FREE FLIGHT**
- Must be at least 100 feet downwind of spectators and automobile parking when the model aircraft is launched.
 - Launch area must be clear of all individuals except mechanics, officials, and other fliers.
 - An effective device will be used to extinguish any fuse on the model aircraft after the fuse has completed its function.
- D. CONTROL LINE**
- The complete control system (including the safety thong where applicable) must have an inspection and pull test prior to flying.
 - The pull test will be in accordance with the current Competition Regulations for the applicable model aircraft category.
 - Model aircraft not fitting a specific category shall use those pull-test requirements as indicated for Control Line Precision Aerobatics.
 - The flying area must be clear of all utility wires or poles and a model aircraft will not be flown closer than 50 feet to any above-ground electric utility lines.
 - The flying area must be clear of all nonessential participants and spectators before the engine is started.

If you are not an AMA member, please consider joining. Founded in 1936 and open to anyone interested in model aviation, the AMA is the governing body for model aviation in the United States and sanctions over 2,000 competitions annually. Membership in the AMA provides liability insurance coverage, protects modelers' rights and interests, and is required to fly at most of the 2,700+ R/C sites nationwide.

Academy of Model Aeronautics
5161 East Memorial Drive
Muncie, IN 47302-9252
Toll Free (800) 435-9262
Fax (765) 741-0057

www.modelaircraft.org



TEXTRON AVIATION
Officially Licensed Product
E78023

©2016 Flex Innovations, Inc.
Premier Aircraft™, Potenza™, and Top Value RC™ are trademarks or registered trademarks of Flex Innovations, Inc.
Cessna and Cessna 170 are trademarks or registered trademarks of Textron Innovations, Inc. and are used under license by Flex Innovations, Inc.
DSM®, DSM2™, and DSMX™ are trademarks or registered trademarks of Horizon Hobby LLC
Futaba™ is a registered trademark of Futaba Denshi Kogyo Kabushiki Kaisha Corporation of Japan.
Jeti, UDI, and Jeti Model are trademarks or registered trademarks of Jelen, Ing. Stanislav of Czech Republic
HoTT is a registered trademark of SJ, Inc.