

**Introduction**

When you are investing in a new radio and considering what requirements are important to you, if weight and comfort are primary considerations, followed by the benefit of the excellent system features of ETHOS, then the FrSky Tandem X18(S) radio is an obvious appropriate choice.

The Tandem X18(S) dual-band telemetry radio benefits from an enhanced ergonomic design with rounded and more comfortable hand grips, along with an improved case design to make the radio fully stable when standing. The radio includes easy-to-reach sliders and switches, 4 standard stick trims with additional 2 extra trims added to provide more flexibility with flight attitude adjustments while operating the radio. The X18(S) includes further enhancements with integrated flash storage which improves and simplifies storage operation and use, and the interior of the radio has been designed with space and weight in mind, while still keeping all ETHOS setting and control features for the pilot to enjoy.

**Internal 900MHz/2.4GHz Dual-Band & External Module Bay**

The TD dual-band RF system combines both the features and advantages of FrSky 900MHz and 2.4GHz RF together in one system. The TD features real simultaneous dual-band longrange control with telemetry that achieves reliable end-to-end 4ms latency while maintaining a robust and high-quality signal link. The entire range of TD, ACCESS & ACCST D16 receivers are supported. The built-in TANDEM RF System supports ACCESS and ACCST D16 protocols.

In addition, the Tandem X18(S) includes a rear Lite version module bay to offer more options to connect external devices. FrSky welcomes working compatibility with the 3rd party products with their own developed technology following FrSky verified 3rd party compatibility-testing program.

**ETHOS Operating System**

ETHOS is a thoroughly new operating system, designed from the ground up by RC experts, providing users a powerful, intuitive, and flexible experience that can maximize the fun of RC Hobby!

**Layout**

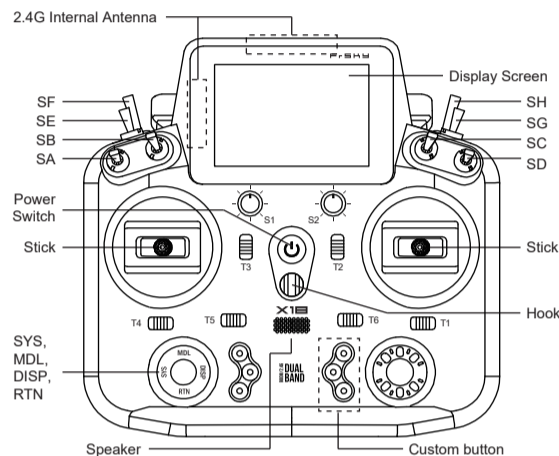

**Switch**

- SA: 3 positions; Short Lever
- SB: 3 positions; Long Lever
- SC: 3 positions; Long Lever
- SD: 3 positions; Short Lever
- SE: 3 positions; Short Lever
- SF: 2 positions; Long Lever
- SG: 3 positions; Short Lever
- SH: 2 positions; Momentary, Long lever

You can choose the Switch and define its position in the HARDWARE menu.

1. USB port is for upgrading, reading/writing Micro SD cards and internal memory of radio contents and charging. (Micro SD card is not provided with shipment.)
2. Smart Port is for firmware upgrade for all FrSky S.Port devices.

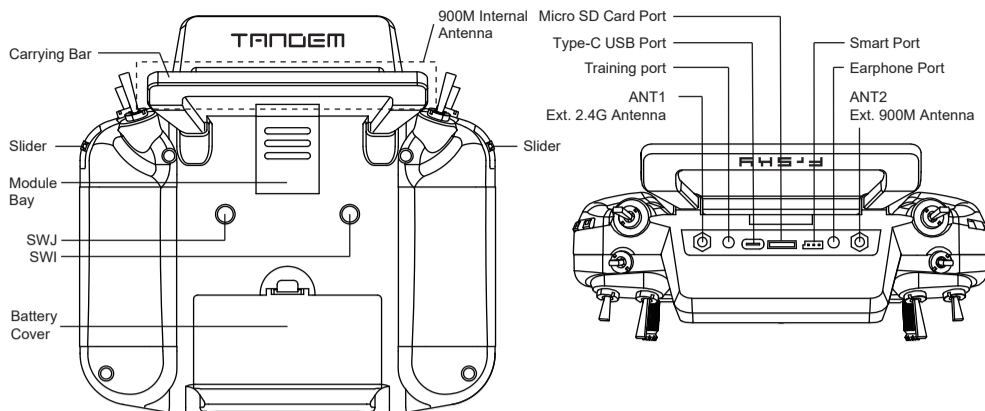

**Infinity 24 Antenna**

Recommended 2.4GHz optional high-gain antenna for achieving higher performance and further range.

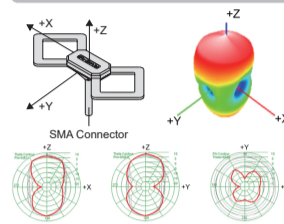

**Zipp9 (868MHz) / Zipp9 (915MHz) Antenna**

Recommended 900MHz optional high-gain antenna for achieving higher performance and further range.

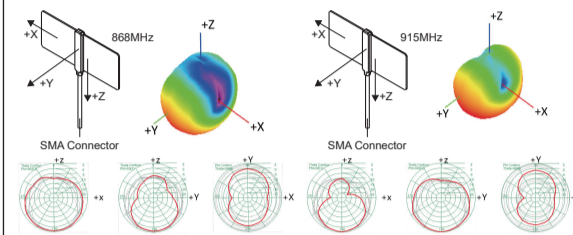

**Note: Please keep the aircraft in the optimal radiation range of the directional antenna at all times.**

**Specifications**

- Dimension: 200\*192\*95mm (L\*W\*H)
- Weight: 687g (Battery Excl.) / 820g (Battery Incl.)
- Operating System: ETHOS
- Internal RF Module: TANDEM
- Number of Channels: Up to 24 channels
- Operating Voltage Range: 6.5~8.4V (2S Li-battery)
- Operating Temperature: -10°C~60°C (14°F~140°F)
- Operating Current: 240mA@7.4V (typ.)
- Charging Current: ≤1A ±200mA
- USB Adaptor Voltage: 5V+0.2V
- USB Adaptor Current: >2.0A
- Backlit touchable LCD resolution: 480\*320
- Compatibility: ACCST D16 & ACCESS & TD receivers
- Internal NAND FLASH: 128MB (X18) / 512MB (X18S)

**Features**

**Hardware**

- Enhanced ergonomic designed case with comfortable rounded hand grips
- 4 Standard Trims with additional 2 extra trims
- Integrate flash storage but also keep the internal TF card slot
- Easy-to-reach top switches and sliders
- With a flat base to improve stability when standing the radio
- Color Touch-Screen Displays
- ★ Upgraded matte screen with improved visibility under sunlight (X18SE)
- High-Precision Hall-Sensor Gimbals with a Metal Panel
- 6 Quick-Mode Custom Buttons (Front) and 2 Momentary Buttons (Rear)
- Lite Type External Module Bay

- Haptic Vibration Alerts and Voice Speech Outputs
- Supports Recharge System for 2S Li-ion Battery (USB Type-C Interface)
- High-speed PARA Wireless Training System
- Supports motion sensing control (X18S)
  - Integrated with 6-axis sensor unit
- All CNC High-Precision Hall-Sensor Gimbals with 10 Ball-Bearing (X18S)

**TD-ISRM RF Module**

- Built-in TD 900M/2.4G Dual-Band Internal RF Module
- Supports Multiple Working Modes
  - 2.4G ACCST D16 Mode (Compatible with ACCST Receivers with D16 V2 or later FW)
  - 2.4G ACCESS Mode (Compatible with ACCESS Receivers)\*
  - 900M ACCESS Mode (Compatible with ACCESS R9 868/915MHz Receivers)\*
  - (\*Capable of simultaneous working under ACCESS mode)
  - 2.4G & 900M TD Mode (Compatible with TD Receivers)
- Long-range control and super-low latency with telemetry
- (\*Up to 50 to 100KM range and down to 4ms end-to-end latency)

**ETHOS System**

- Clear and Intuitive UI Design
- Supports Dual Operation Modes of Radio Display (Touch and Non-Touch)
- Supports Multi-Language Switching
- Hardware/Software Version and Factory Version Detection
- Supports running LUA Scripts

**2S Li-battery balance charging via USB-C:**

The Green LED indicator states:  
 Led on: in Charging/Led off: end of charge/flash: charge fault  
 Battery compartment size: 87\*41\*19.5mm (L\*W\*H)

- Note:**
1. Charge the battery with the USB adapter (Voltage: 5V+0.2V Current: > 2.0A) when you use the USB charging function.
  2. The lower the initial charging voltage, the better the charging effect is when the voltage difference cells exceed 50 mV between the two.

**Navigation Controls**

The left navigation control does RTN, SYS, MDL, DISP, and Page UP/Down. The right navigation control does scroll and enter. Both navigation controls and touch screen can be used to control the system.

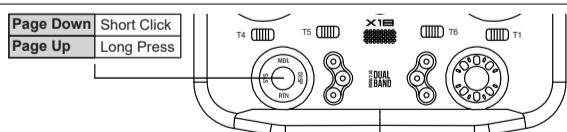

**ETHOS Suite**

With ETHOS Suite, you can update the radio bootloader, firmware, SD card, flash, and also convert image format and audio format. Find the latest information and download the ETHOS Suite at ethos.frsky-rc.com/.

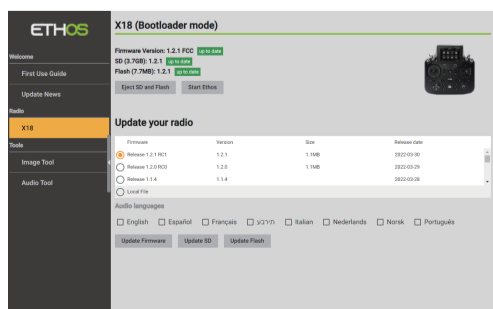

**Note: To use the ETHOS Suite application with a FrSky radio, please always keep the radio bootloader with the latest version.**

**ETHOS Operating System**

**Create the model**

**Step 1:** First go to System Settings, then click Model Select to select the model type.

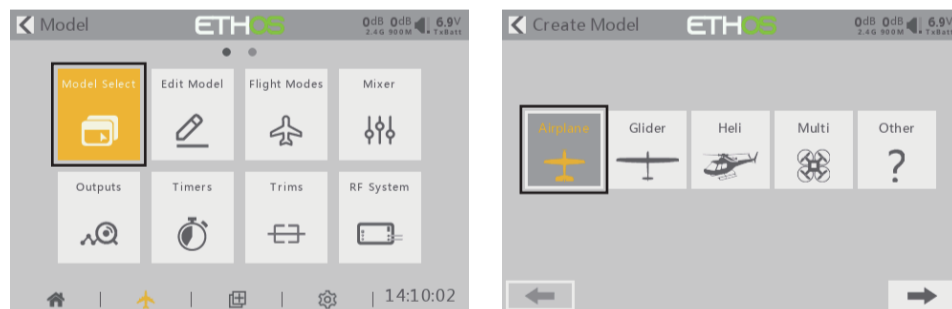

**Step 2:** Configure the model channel and create the model name.

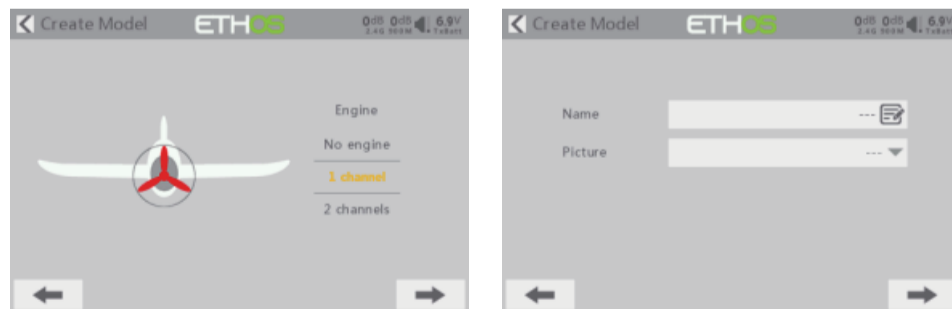

**Model Setup Procedure-Internal Module**

**Step 1:**



Touch the screen or use the navigation keys to enter the RF system menu.

Choose the INT MODULE. Then turn ON INTERNAL RF, select the OUTSIDE or INSIDE ANTENNA. Set the Mode for TANDEM X18 internal RF corresponding to your receiver (ACCESS, ACCST D16).

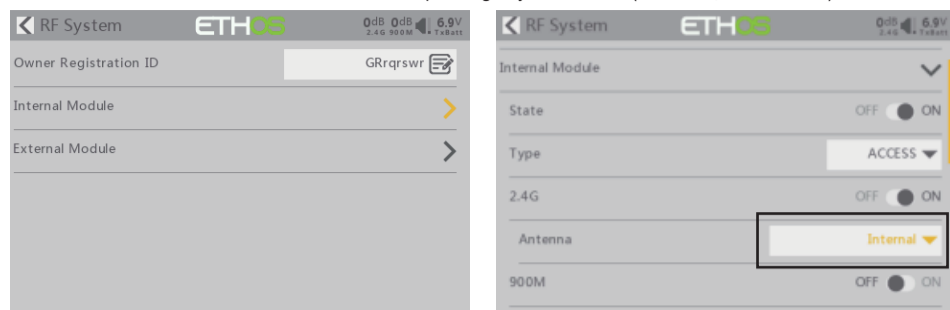
**Step 2: Set the Channel Range**

The TANDEM RF module supports 24 channels, the channel range is configurable, and it needs to be double checked before use.

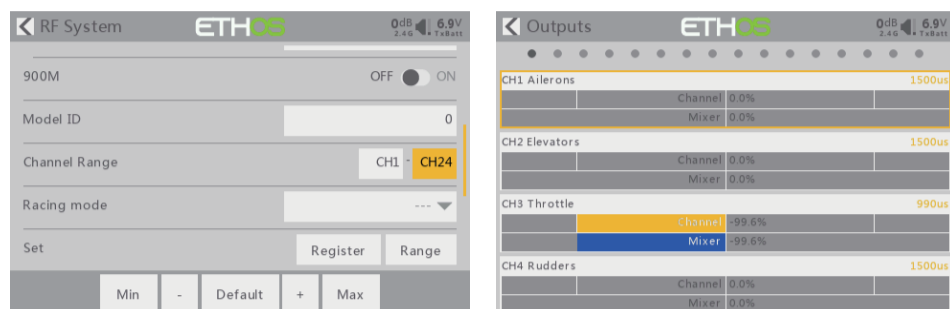
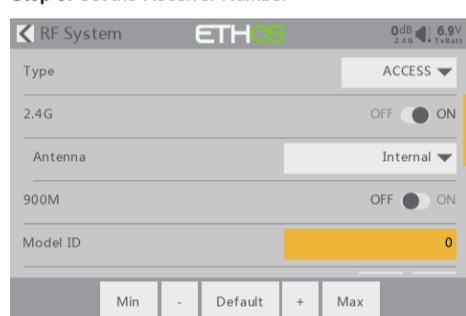
**Step 3: Set the Receiver Number**

The system will assign you the receiver a number automatically, when you create a new model, and this can be easily changed. The range of the Model ID is 00-63, with the default number being 01. Once the receiver is set to the desired number and is bound to the TANDEM X18, the bind procedure will not need to be repeated unless the receiver number is changed. At this point, set the receiving number to your preferred number and repeat the binding operation.

**Step 4 : Registration**

In ACCESS model, select the STATE [Register] into Registration status on radio side. Then Press the F/S button and power on your receiver, and select the "RX Name XX" and [REGISTER] to complete the Registration process then power down the receiver.

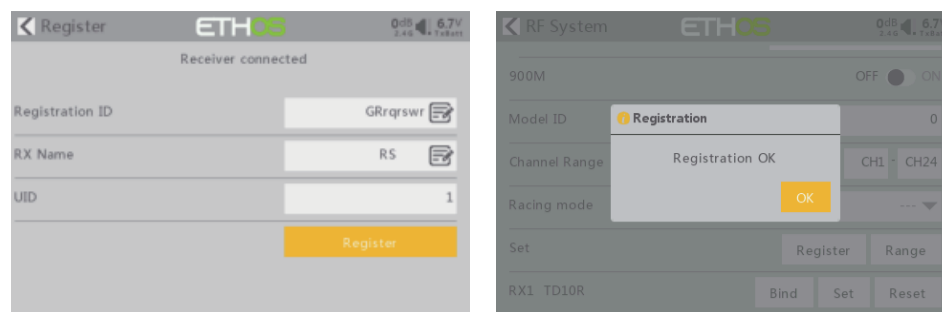
**Step 5: Automatic binding (Smart Match )**

Move the cursor to Rx1[BIND], and select it, power your receiver, select the RX, and complete the process, the system will confirm "Bind succeed". (Pressing the "F/S" button is not required in ACCESS to Bind. Please refer to the receivers manual for details).

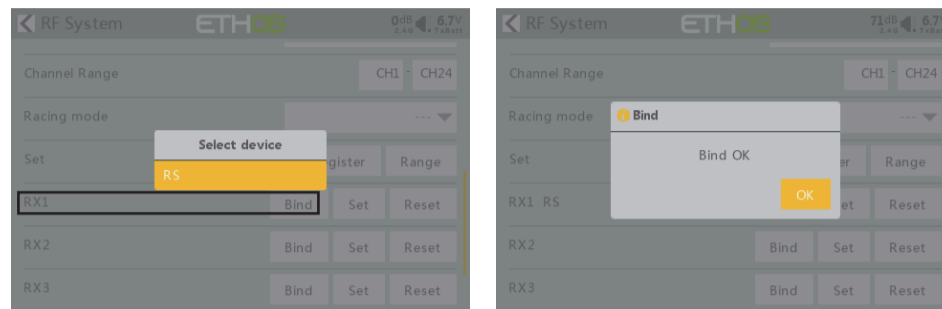
**Step 6: Set Failsafe mode**

There are 3 failsafe modes when enable: No Pulse, Hold, Custom.

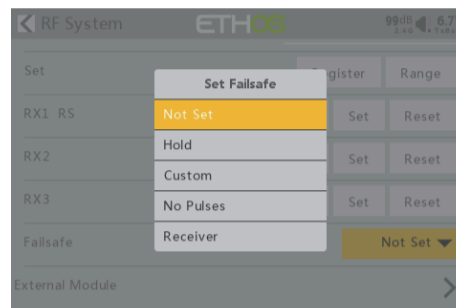

- No Pulse: on loss of signal the receiver produces no pulses on any channel. To use this type, select it in the menu and wait 9 seconds for the failsafe to take effect.
- Hold: the receiver continues to output the last positions before signal was lost. To use this type, select it in the menu and wait 9 seconds for the failsafe to take effect.
- Custom: pre-set to required positions on lost signal. Move the cursor to the failsafe mode of channel and press Encoder, then choose the Custom mode. Move the cursor to the channel you want to set failsafe on, and press Encoder.

Then rotate the Encoder to set your failsafe for each channel and short press Encoder to finish the setting. Wait 9 seconds before the failsafe takes effect.

**Notice:**

- When failsafe is disabled on TANDEM X18 side, the failsafe set on receiver side will be used.
- SBUS/F.Port/FBUS port does not support the No Pulse failsafe mode and always outputs. Set "Hold" or "Custom" for SBUS port.

**Step 7: Range**

Range refers to TANDEM X18 range check mode. A pre-flight range check should be done before each flying session. Move the cursor to "Set", scroll the Encoder to select "RANGE" mode and press Encoder. In range check mode, the effective distance will be decreased to 1/30. Press the Encoder again, turn to normal state.

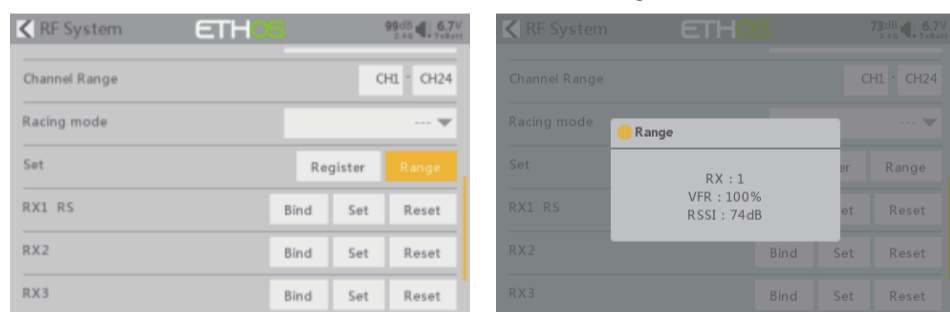
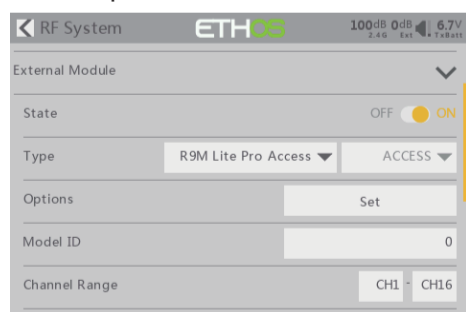
**Model Setup for TANDEM X18 External RF Module**

The external RF module can be powered on or off by software. The setup process is the same as that for the internal RF. External modules should be closed when not in use.

**FCC**

This equipment has been tested and found to comply with the limits for a Class B digital device, pursuant to part 15 of the FCC Rules

**CE**

The product may be used freely in these countries: Germany, Italy, Spain, Belgium, Netherlands, Portugal, Greece, Ireland, Denmark, Luxembourg, Austria, Finland, Sweden, Norway, France and Iceland.

**FLYING SAFETY**
**Warning:**

To ensure the safety of yourself and others, please observe the following precautions.

1. **Have regular maintenance performed.** Although your TANDEM X18 protects the model memories with non-volatile EEPROM memory (which does not require periodic replacement) and of a battery, it still should have regular check-ups for wear and tear. We recommend sending your system to your FrSky Service Center annually during your non-flying-season for a complete check-up and service.

**Battery**

① Using a fully charged battery (DC 6.5~8.4V). A low battery will soon die, causing loss of control and a crash. When you begin your flying session, reset your transmitter's built-in timer, and during the session pay attention to the duration of usage. Also, if your model used a separate receiver battery, make sure it is fully charged before each flying session.

① **Stop flying long before your batteries become over discharged. Do not rely on your radio's low battery warning systems, intended only as a precaution, to tell you when to recharge. Always check your transmitter and receiver batteries prior to each flight.**

**Where to Fly**

We recommend that you fly at a recognized model airplane flying field. You can find model clubs and fields by asking your nearest hobby dealer.

① **Always pay particular attention to the flying field's rules**, as well as the presence and location of spectators, the wind direction, and any obstacles on the field. Be very careful flying in areas near power lines, tall buildings, or communication facilities as there may be radio interference in their vicinity.

**At the flying field**

1. To prevent possible damage to your radio gear, turn the power switches on and off in the proper sequence:
  1. Pull throttle stick to idle position, or otherwise disarm your motor/engine.
  2. Turn on the transmitter power and allow your transmitter to reach its home screen.
  3. Confirm the proper model memory has been selected.
  4. Turn on your receiver power.
  5. Test all controls. If a servo operates abnormally, don't attempt to fly until you determine the cause of the problem.
  6. Start your engine.
  7. Complete a full range check.
  8. After flying, bring the throttle stick to idle position, engage any kill switches or otherwise disarm your motor/engine.

If you do not turn on your system on and off in this order, you may damage your servos or control surfaces, flood your engine, or in the case of electric-powered or gasoline-powered models, the engine may unexpectedly turn on and cause a severe injury.

① **Make sure your transmitter can't tip it over.** If it is knocked over, the throttle stick may be accidentally moved, causing the engine to speed up. Also, damage to your transmitter may occur.

① In order to maintain complete control of your aircraft it is important that it remains visible at all times. Flying behind large objects such as buildings, grain bins, etc. must be avoided. Doing so may interrupt the radio frequency link to the model, resulting in loss of control.

⊗ Do not grasp the transmitter's antenna during flight. Doing so may degrade the quality of the radio frequency transmission and could result in loss of control.

⊗ As with all radio frequency transmissions, the strongest area of signal transmission is from the sides of the transmitter's antenna. As such, the antenna should not be pointed directly at the model. If your flying style creates this situation, easily move the antenna to correct this situation.

① **Don't fly in the rain!** Water or moisture may enter the transmitter through the antenna or stick openings and cause erratic operation or loss of control. If you must fly in wet weather during a contest, be sure to cover your transmitter with a plastic bag or waterproof barrier. Never fly if lightning is expected.

**Updates**

FrSky is continuously adding features and improvements to our radio systems. Updating (via USB Port or the Micro SD card) is easy and free. To get the most from your new transmitter, please check the download section of the FrSky website for the latest update firmware and guide for adjusting your sticks. ([www.frsky-rc.com](http://www.frsky-rc.com))

FrSky is continuously adding features and improvements to our products. To get the most from your product, please check the download section of the FrSky website [www.frsky-rc.com](http://www.frsky-rc.com) for the latest update firmware and manuals