

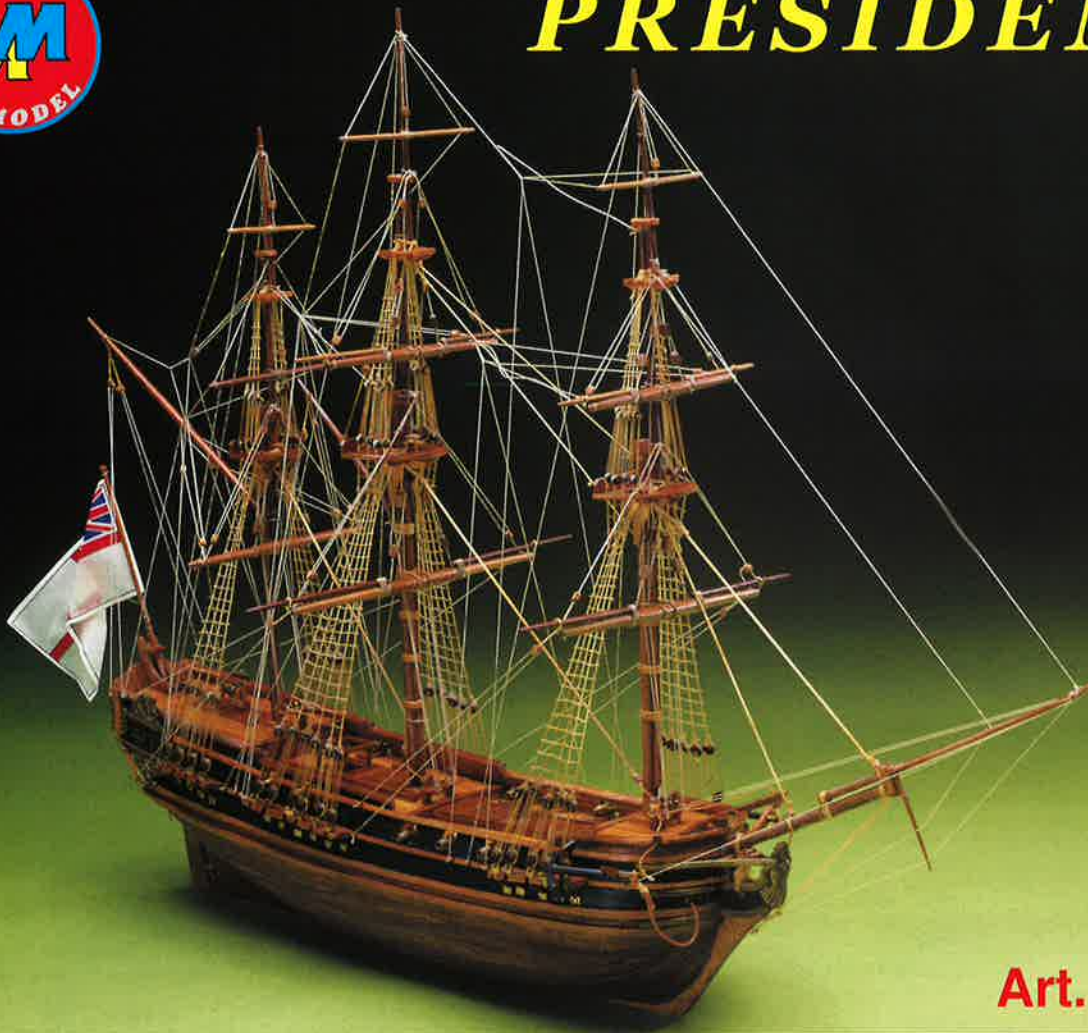

PRESIDENT



Art. 792

1015



1016



Art. 1015 SUPER-GLUE

Colla vinilica rapida
White glue
Wasserfester weißleim
Colle blanche
Witte houtlijm
Cola vinilica rápida

Art. 1016 ALI-GLUE

Colla alifatica rapida
Aliphatic glue
Wasserfester aliphaticleim
Colle aliphatique
Alifatische houtlijm
Cola alifática rápida



Cianoacrilato
Super glues
Sekundenkleber
Colles cyanoacrylates
Secondenlijm
Cianoacrilato

Art. 1565 20 gr.

Art. 1020 100 cc.

Vernice di fondo trasparente per legno
Clear primer for wood
Porenfüller, farblos für Holz
Bouche-pores pour bois
Primer & porienvuller voor hout
Barniz de fondo transparente para madera



Art. 1022 100 cc.

Stucco - Putty - Spachtel
Mastic - Vulmiddel - Masilla



**Art. 1740
Set**

Colori acrilici ad acqua per modellismo navale
Wash up acrylic paint for ship builder
Die Acrylic Farbe Seifenwasser für Schiffsmodelle
Couleurs acryliques à base d'eau pour modélisme naval
Acrylkleuren voor modelbouw-water oplosbaar
Pinturas acrílicas al agua para modelismo naval

Art. 1750 bianco - white - weiß - blanc - wit - blanco
Art. 1751 nero - black - schwarz - noir - zwart - negro
Art. 1752 giallo - yellow - gelb - jaune - geel - amarillo
Art. 1753 rosso - red - rot - rouge - rood - rojo
Art. 1754 blu - blue - blau - bleu - blauw - azul
Art. 1755 ocre - ochre - ocker - ocre - oker - ocre

Attrezzatura: Per la costruzione del primo stadio costruttivo di questo modello, lo scafo, abbiamo bisogno di alcuni attrezzi che Vi elenchiamo. Martello piccolo - Tagliabalsa con lame molto affilate - Serie limette - Rastrema listelli - Serie tamponi a carta vetrata - Carta vetrata grossa e fine - Serie spilli con testa - 6 pinzette di legno - 1 pennello. Se alcuni di questi utensili Vi dovesse mancare, li potrete acquistare dal Vostro negoziante, sulla base del catalogo attrezzistica, contenuto nella scatola.

Tools: To build this first steps of the model or hull, below is listed some of tools needed. Small hammer - Cutter with sharp blades - Set of files - Strip clamp machine - set of sanding sticks - 2 grades of sand paper - Set of headed pins - 6 pegs - one brush.

If you do not have some of these tools, you can buy them at your local hobby shop, following our tool catalogue supplied with the kit.

Werkzeug: Für den Bau der ersten Konstruktionsphase dieses Modells, dem Rumpf, benötigt man folgende unten angeführte Werkzeuge. Ein kleiner Hammer - einen Sockelschneider mit sehr scharfen Klingen - einen Satz Feilen - eine Vorrichtung zur Verjüngung der Leisten - einen Satz Schmirgelkissen - grobes und feines Sandpapier - einen Satz Stecknadeln - 6 Holzpinzetten - 1 Pinsel. Sollten Ihnen einige dieser Werkzeuge fehlen, können Sie diese bei Ihrem Händler anhand des Zubehörkatalogs, welcher Ihrer Verpackung beigelegt ist, erwerben.

Équipement: Pour la construction du premier stade de construction de ce modèle, la coque, nous avons besoin de quelques outils que nous vous énumérons: Un petit marteau - un couteau à balsa avec des lames très tranchantes - une série de petites limes - l'étau à lattes - une série de cales à poncer - du papier de verre de grain gros et fin - une série d'épingles avec tête - 6 pincettes de bois - 1 pinceau.

Si quelques uns de ces outils devait vous manquer, vous pourrez les acquérir chez votre revendeur, sur la de base du catalogue d'outillage, contenu dans la boîte.

De uitrusting: Voor de bouw van het eerste stadium van bouw van dit model, de schaal, hebben wij enkele werktuigen nodig die wij u opsommen: Een kleine hamer - mes voor balsahout met zeer snijdende plaatjes - een reeks van kleine vijlen - de bankschroef voor lijstjes - een reeks schuurpapier ruw en fijn - een reeks spelden met hoofd - 6 tangetjes in hout - 1 penseel. Als enkele deze werktuigen u moesten gebrek hebben aan, zult u ze kunnen verkrijgen bij uw kleinhandelaar, op basis van de catalogus van werktuigen, catalogus geleverd in de doos.

Equipamiento: Para la construcción de la primera fase de este modelo, el casco, es necesario emplear algunas herramientas que pasamos a enumerar. Martillo pequeño - Cúter con las hojas muy afiladas - Varias limas - Ahusador de listones - Varios taponos de papel de lija - Papel de lija grueso y fino - Varios afileres con cabeza - 6 pinzas de madera - 1 pincel. Si le hace falta alguna de estas herramientas, podrá adquirirla en su tienda habitual, en base al catálogo de utensilios, que se encuentra dentro de la caja.

Carta vetrata - Sand-paper - Schleifpapier
Papier de verre - Schuurpapier
Brosni papir - Papel de lija

Art. 8011 grana - grain - Körnung
korrel - gradacija - grano 80
Art. 8012 grana - grain - Körnung
korrel - gradacija - grano 180

23x27 cm.



Art. 8160

Tornio elettrico per legno - Wood working lathe
Holz-DrehbanTour a bois
Electrische houtdraaibank
Torno eléctrico para madera

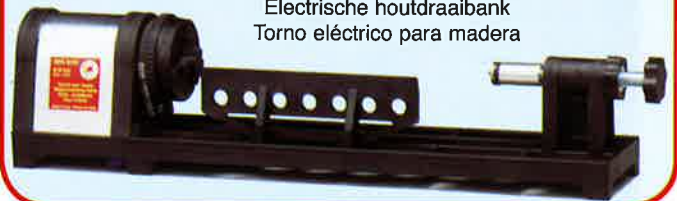

Art. 8297



Martello professionale - Hammer - Hammer
Marteau professionnel - Professionele Hamer
Martillo profesional

Art. 8263

Coltello leggero in alluminio - Light alu knife
Messer Leichte Ausführung
mit Aluminiumgriff
Couteau léger
en aluminium
Licht mes
in aluminium
Cuchillo ligero de aluminio

Art. 8200 5P.

Lama inclinata
Ersatzklingen
Long angled blade
Lame inclinée
Schuin blad
Cuchilla inclinada



Levigatori a carta vetrata doppia faccia - Double face sanding stick
Schleifer mit 2-Schleifpapieren - Stick à poncer double face
Schurrblok voor 2-zydig schuurpapier - Pulidor de hoja de doble lija

Grana - Grain - Körnung - Korrel - Grano 80 e 220

Art. 8190 mm 20x80 **Art. 8191** mm 30x100

Art. 8192 mm 40x120 **Art. 8193** mm 50x140

Art. 8194 mm 60x160

Art. 8195 Serie 5 pezzi - Set of 5 pieces - Satz 5 stück
Assortiment de 5 pièces - Serie 5 piezas



Art. 8300

Serie limette con impugnatura - Set of files with handle
Nadelfeilen-Set - Set limes avec manche
Set van vijlen met heft - Varias limas con empuñadura

Rastremalistelli e supporto scafo - Strip clamp & hull holder

Leistenschneider und kielklemme

Etau pour listeau et fixation de quille

Klamp voor latten en kielhouder

Ahusador de listones y soporte del casco



Art. 8155

Spilli da lavoro
Plastic-head pins
Stecknadeln
Epingles à tête en
plastique
Steeknaalden
Alfileres de trabajo



Art. 2476

Art. 8178

Mollette di serraggio
Pegs - Pincas - Klammern
Knijpers - Pinzas de sujeción



Art. 1556

Pennello - Brush - Pinsel - Piceau - Borstel - Pincel

1

Numerare le parti - Number the parts
Die Teilenummern sind im Bauplan wiedergegeben
Numéroter les pièces - Nummeren van de stukken
Numerar las piezas una a una

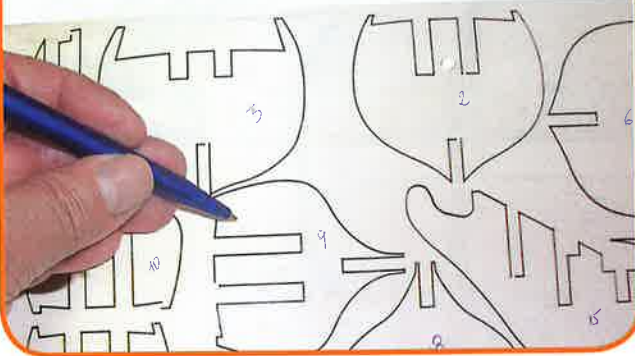

2

Tagliare i ponticelli - Cut the small bridges
Schneiden sie die kleinen Stege durch
Couper les pontets - Snijd de bruggen
Cortar los puentes

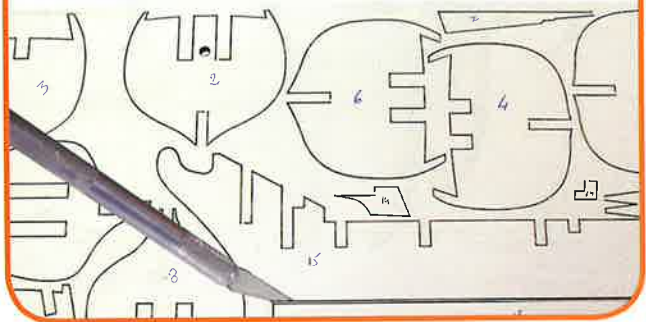

3

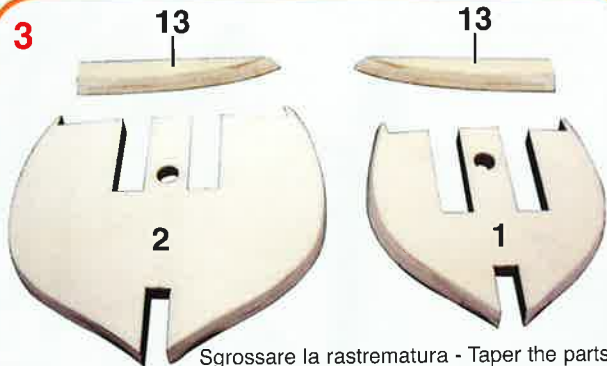

Sgrossare la rastrematura - Taper the parts
Verschiedenen alle Teile - Dégrossir le biseautage
Bewerken het afschuinieng van the stukken
Tallar el ahusado

4

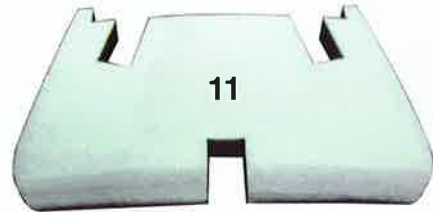

Sgrossare la rastrematura
Taper the parts
Verschiedenen alle Teile
Dégrossir le biseautage
Bewerken het afschuinieng van the stukken
Tallar el ahusado

5

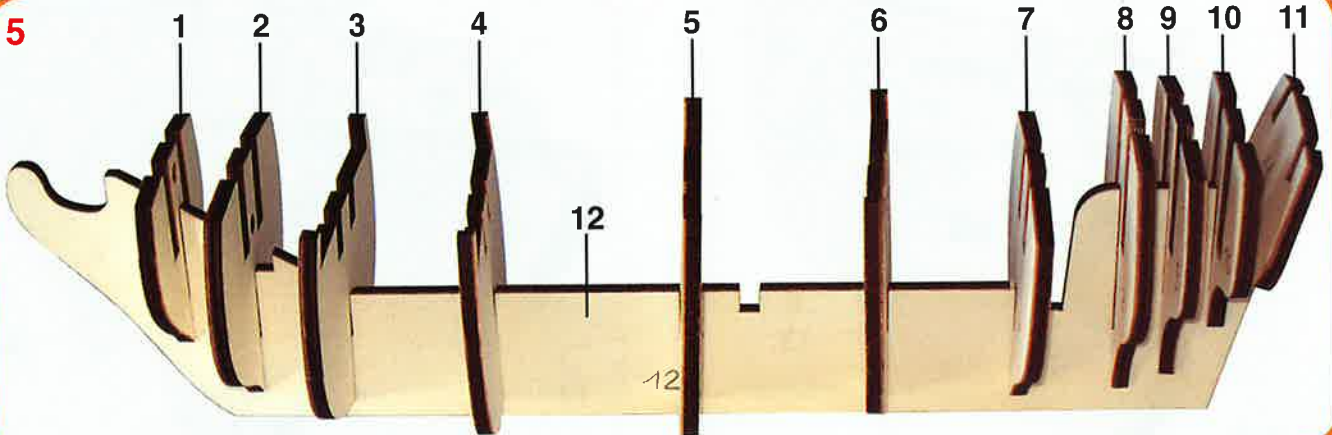

6

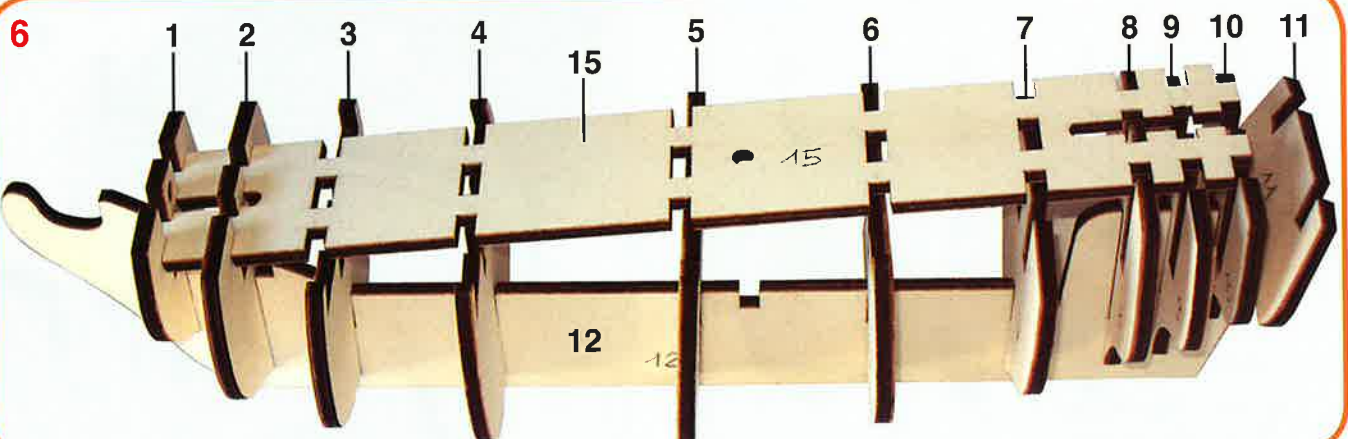

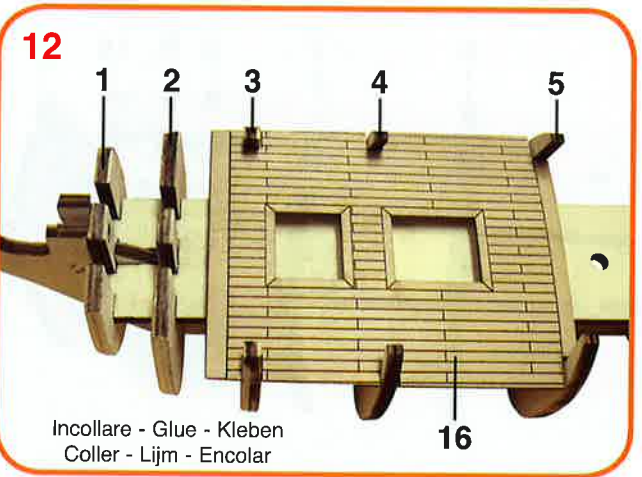
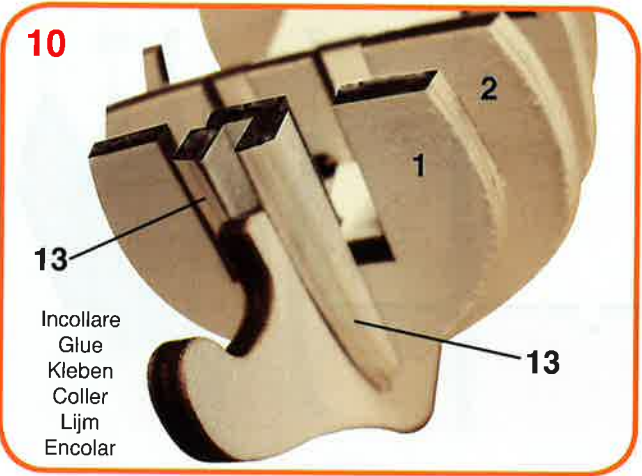
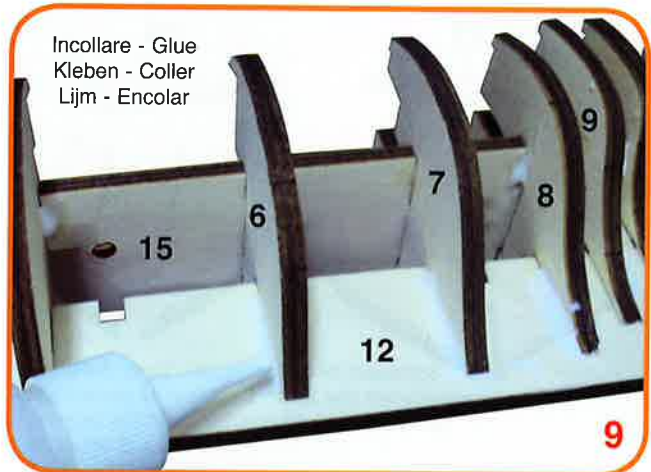
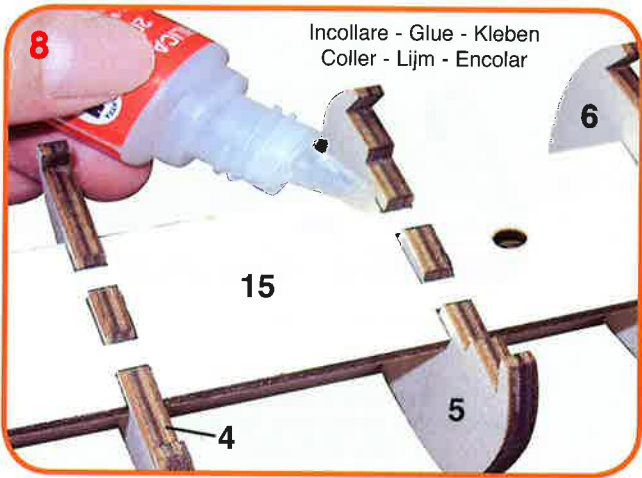
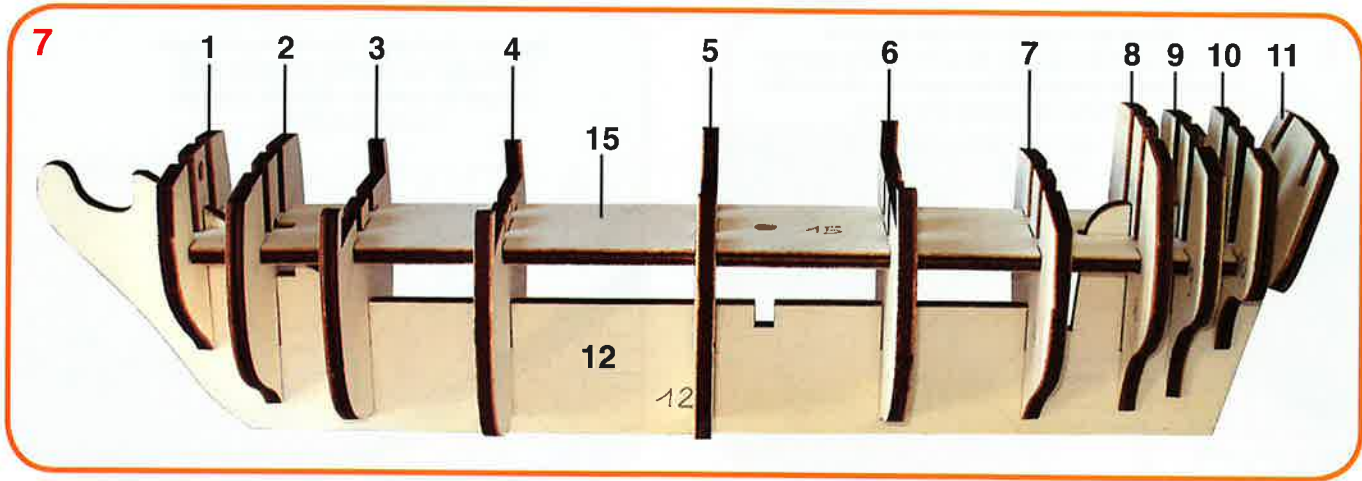

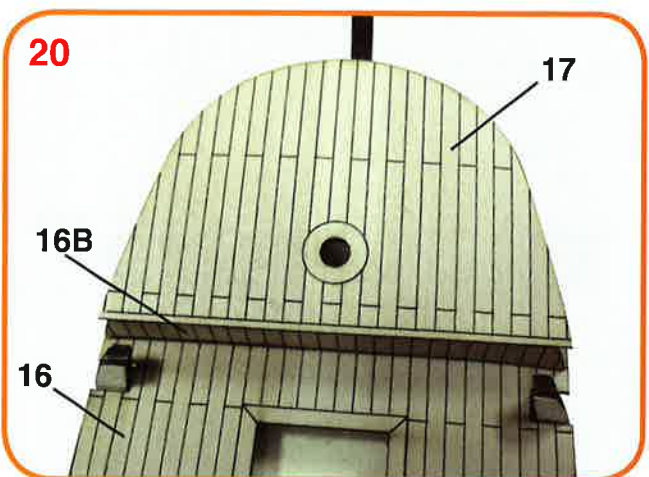
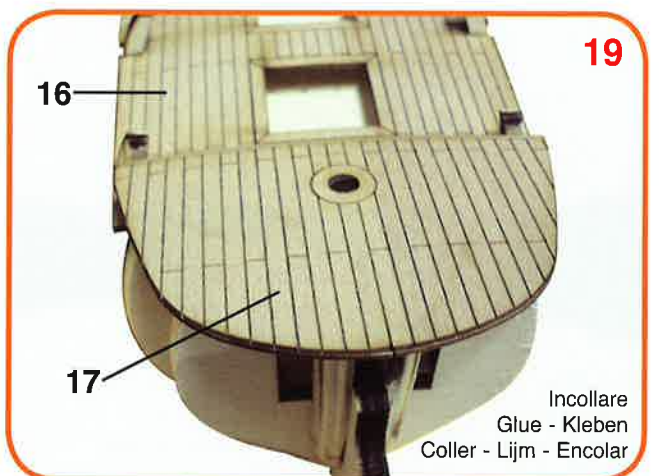
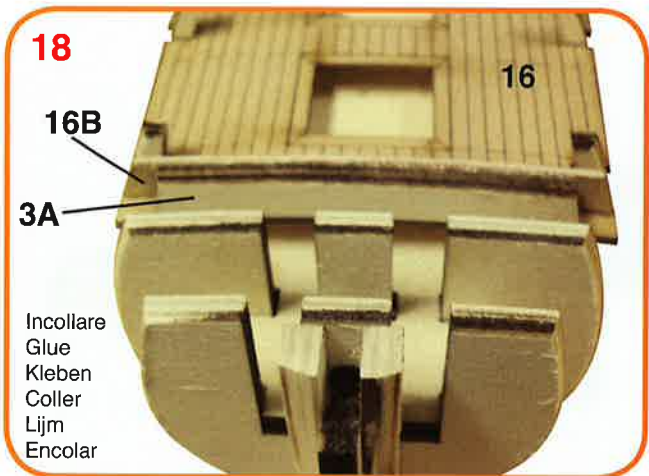
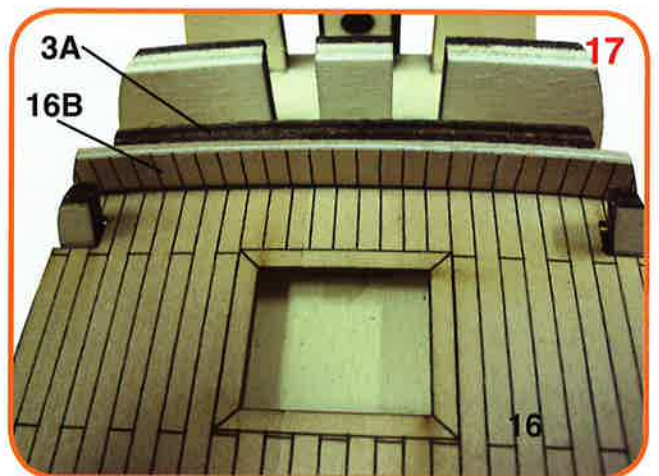
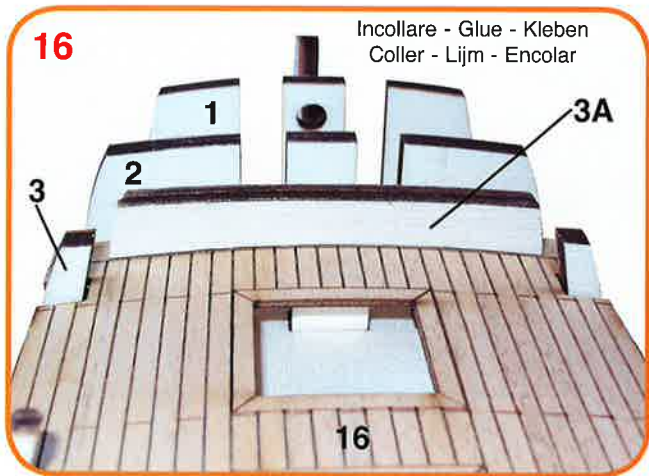
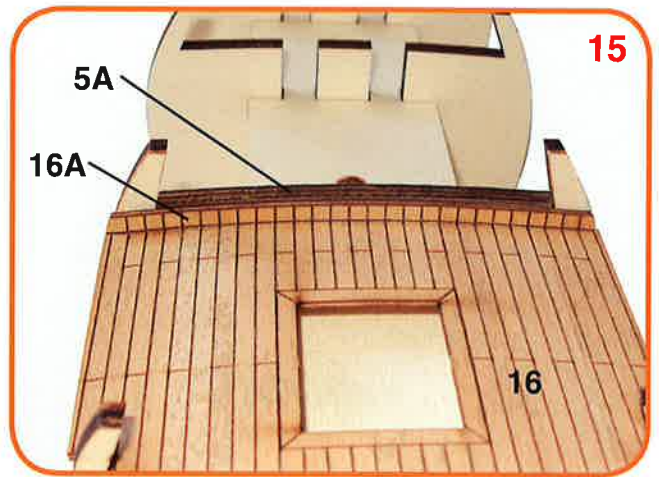
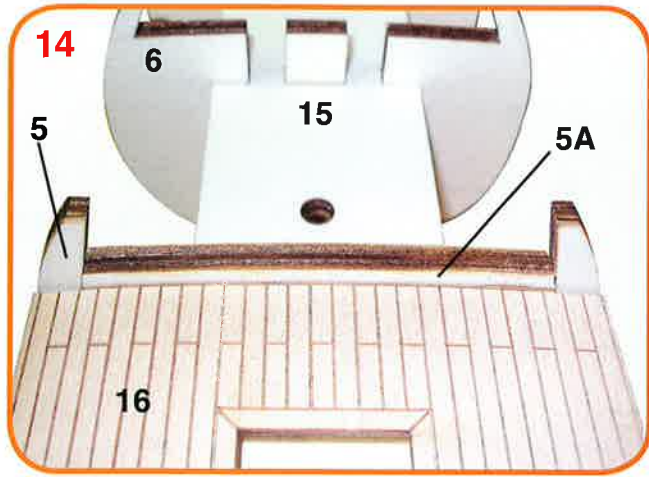

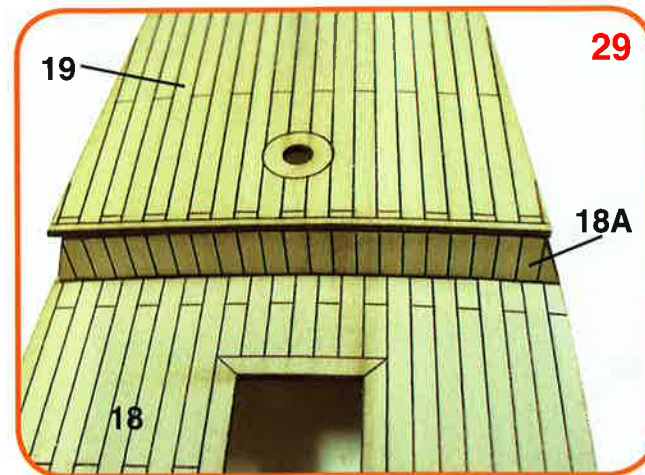
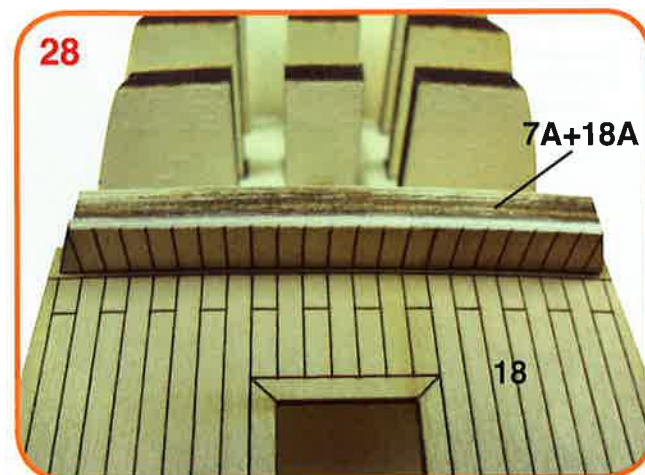
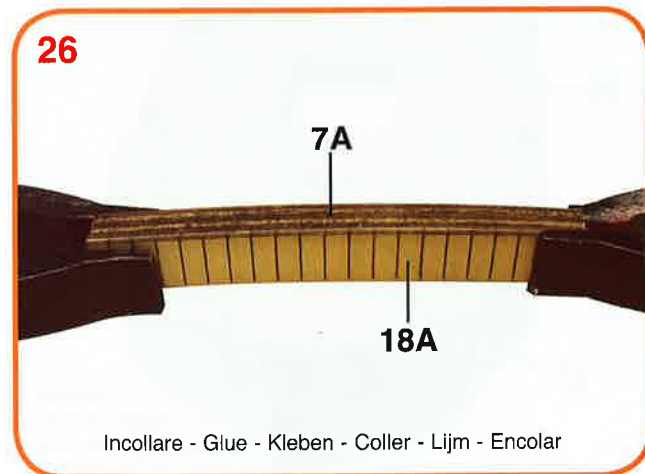
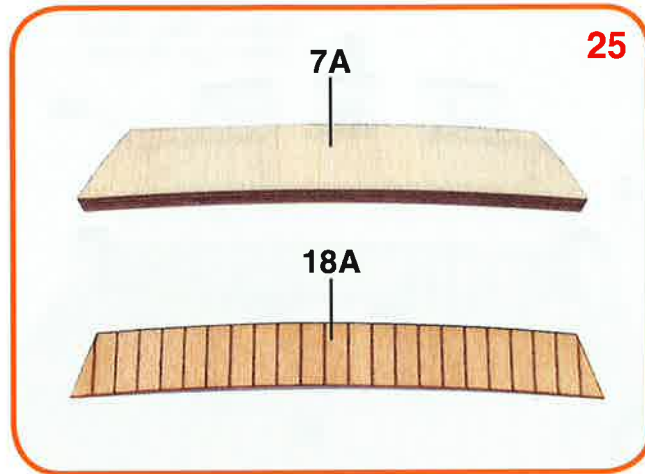
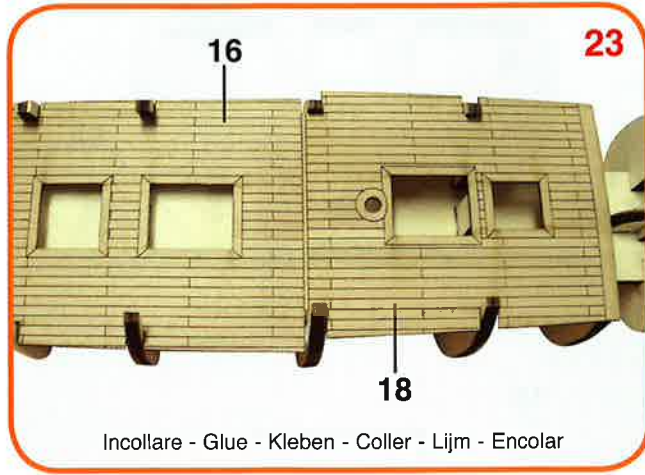
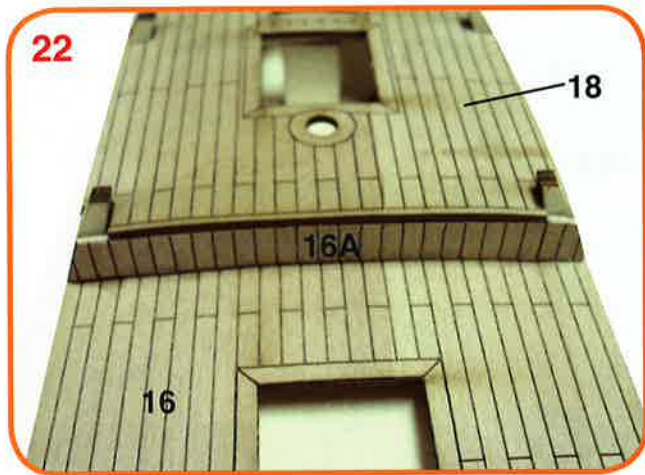

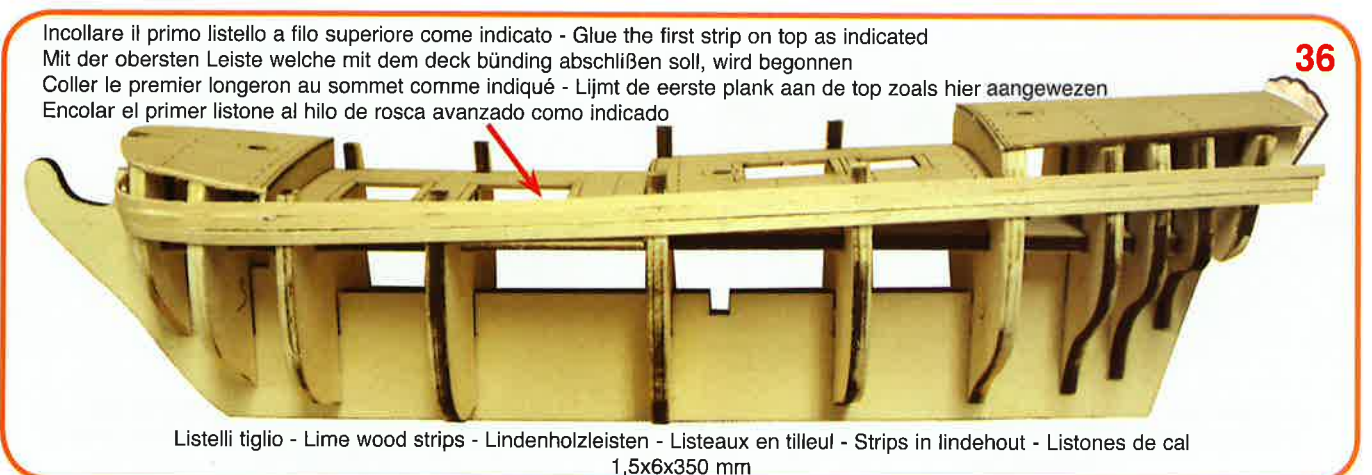
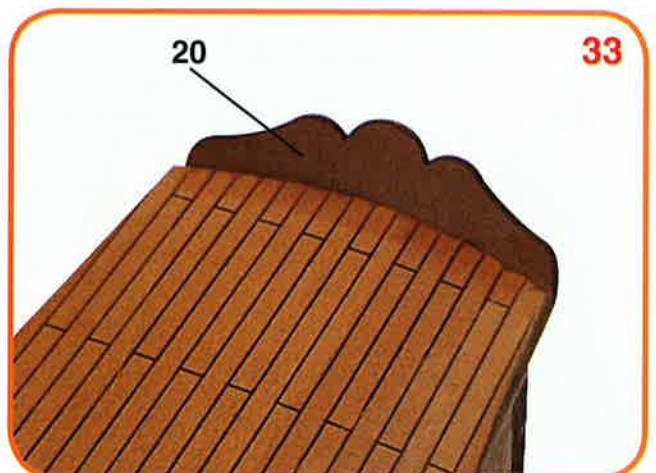
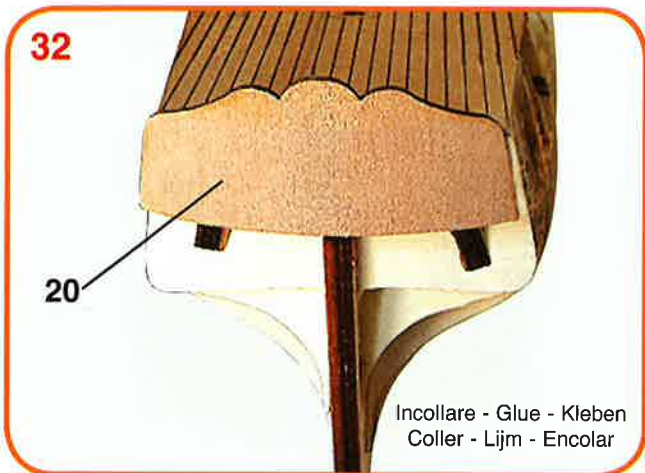
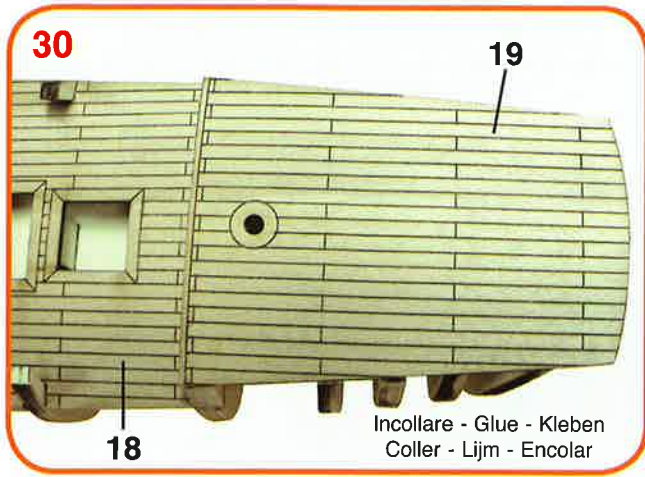

37

Listelli tiglio - Lime wood strips - Lindenholzleisten
 Listeaux en tilleul - Strips in lindehout - Listones de cal
 1,5x6x350 mm

**38**

Listelli tiglio - Lime wood strips - Lindenholzleisten
 Listeaux en tilleul - Strips in lindehout - Listones de cal
 1,5x6x350 mm

**39**

Listelli tiglio - Lime wood strips - Lindenholzleisten
 Listeaux en tilleul - Strips in lindehout
 Listones de cal
 1,5x6x350 mm

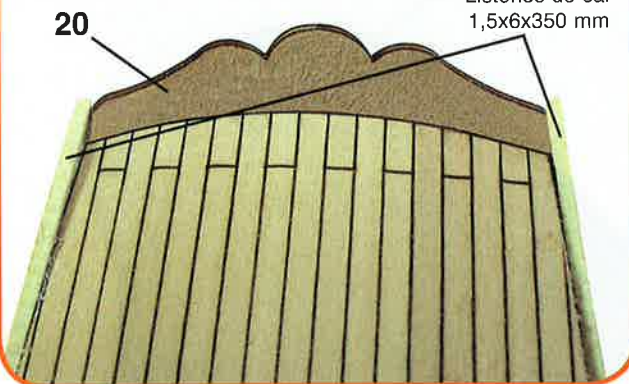
**40****41**

Alternando le fiancate, mettete in opera due o tre listelli per volta. Questo sistema di posa del fasciame impedirà allo scafo di deformarsi
 Place two strips each side to avoid twisting problems to the body
 Jeweils die Seiten wechselnd, verwenden Sie jedes Mal zwei oder drei Leisten. Diese Art der Beplankung verhindert die Deformierung des Rumpfs
 Mettre deux baguettes alternativement de chaque côté pour éviter les problèmes de vrillage de la coque
 Plaats twee strips langs iedere kant van de romp om verdraaiingen te voorkomen
 Para evitar cualquier posible problema, alternar el forrado de los lados cada 3 tracas pegadas

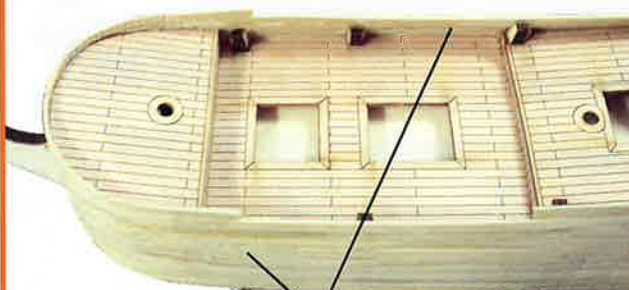
42

Listelli tiglio - Lime wood strips - Lindenholzleisten
 Listeaux en tilleul - Strips in lindehout - Listones de cal
 1,5x6x350 mm

43

Listelli tiglio - Lime wood strips - Lindenholzleisten
 Listeaux en tilleul - Strips in lindehout - Listones de cal
 1,5x6x350 mm

44

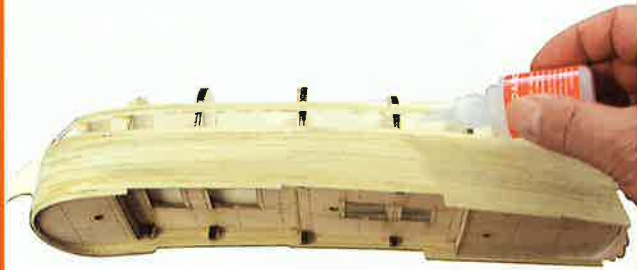

Incollare - Glue - Kleben
Coller - Lijm - Encolar

45

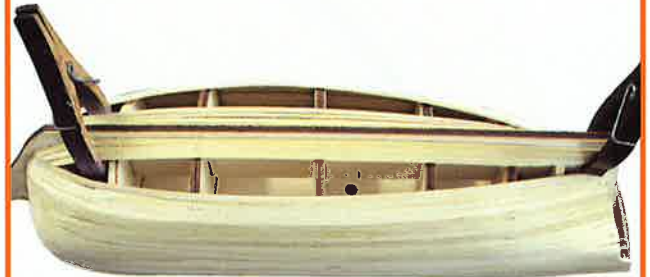

46



47



48



Listelliiglio - Lime wood strips - Lindenholzleisten - Listeaux en tilleul - Strips in lindehout - Listones de cal
1,5x6x350 mm

49



Carteggiare - Sand - Schleifen - Poncer - Schuur - Lijar

50



51



52



Passare una mano di colla alifatica diluita al 30% - Coat the surface with aliphatic glue diluted 30%
 Danach als Imprägnierung eine Schicht 30% verdünnten Aliphatickleber auftragen
 Passer une couche de colle aliphatique diluée à 30% - Vervolgens een laag van aliphatische lijm voorbijgaan die aan 30%
 Dar una mano de cola alifática diluida al 30%

53



Stuccare - Putty - Verspachteln - Stuquer - Vullen - Estucar

Consigliato - Recommended - Empfohlen - Recommandé - Geadviseerd - Recomendado
 Art. 1022

54



Carteggiare - Sand - Schleifen - Poncer - Schuur - Lijer

55

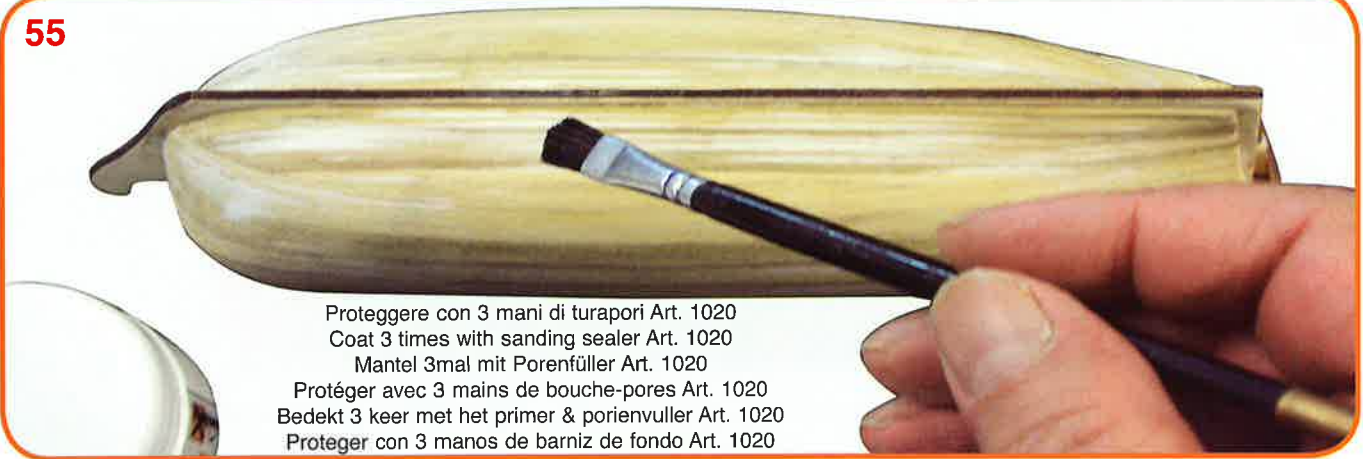

Proteggere con 3 mani di turapori Art. 1020
 Coat 3 times with sanding sealer Art. 1020
 Mantel 3mal mit Porenfüller Art. 1020
 Protéger avec 3 mains de bouche-pores Art. 1020
 Bedekt 3 keer met het primer & porienvuller Art. 1020
 Proteger con 3 manos de barniz de fondo Art. 1020

56



Carteggiare - Sand - Schleifen - Poncer - Schuur - Lijar

57



Verniciare color rame - Paint copper - Kupferfarben lackieren - Peindre en couleur cuivre
 Verbergen en in koper kleur schilderen - Barnizar de color cobre

Sistema pratico per tracciare l'esatta linea di galleggiamento,
 l'attrezzo è ricavato da due ritagli di compensato.
 Easy system to trace the exact waterline,
 the tool is made with two scraps of plywood.
 Praktisches System, um die genaue Wasserlinie
 verfolgen, das Tool basiert auf zwei Fetzen
 von Sperrholz Basis.
 Un système très pratique pour tracer la ligne
 de flottaison exacte, l'outil est basé sur
 deux morceaux de contreplaqué.
 Praktisch systeem om de exacte waterlijn op te
 sporen, de tool is gebaseerd op twee stukjes triplex.
 Práctico sistema para trazar la línea de flotación
 exacta, la herramienta se basa en dos
 trozos de madera.

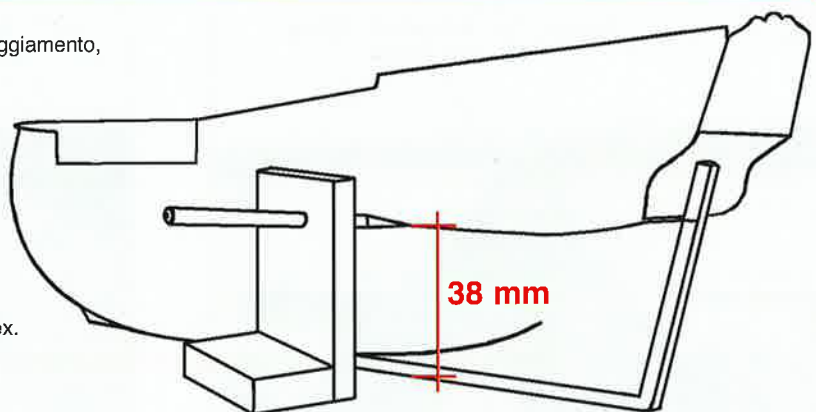

58

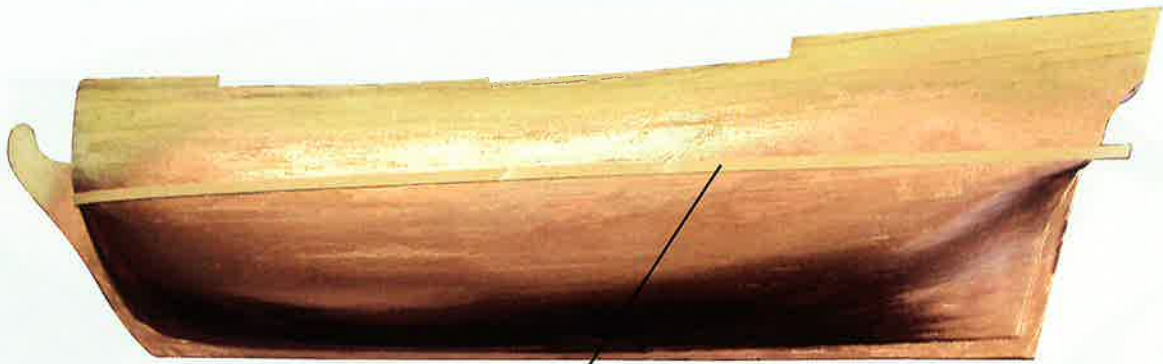

Listelli noce - Walnut strips - Nußbaumleisten - Listeaux en noyer - Strips notelaar - Listones de nogal
1x3 mm

59

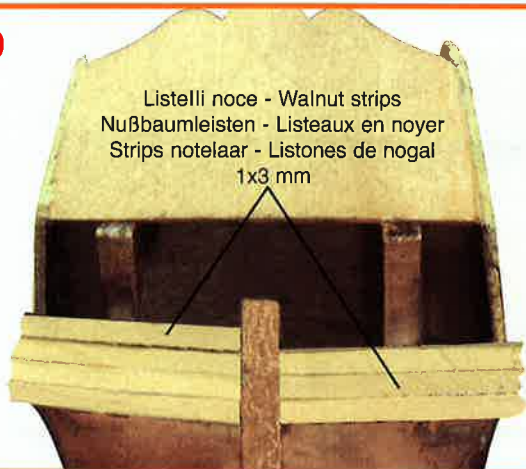

Listelli noce - Walnut strips
Nußbaumleisten - Listeaux en noyer
Strips notelaar - Listones de nogal
1x3 mm

60

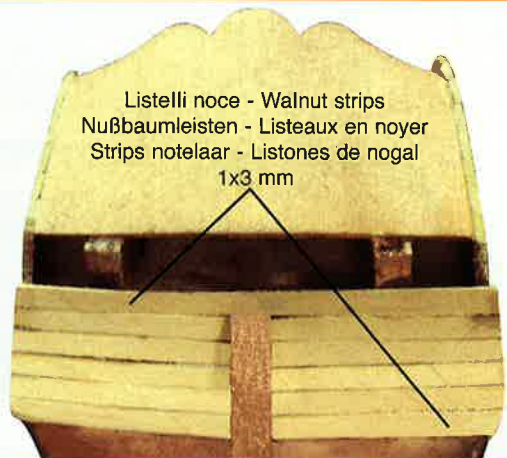

Listelli noce - Walnut strips
Nußbaumleisten - Listeaux en noyer
Strips notelaar - Listones de nogal
1x3 mm

61

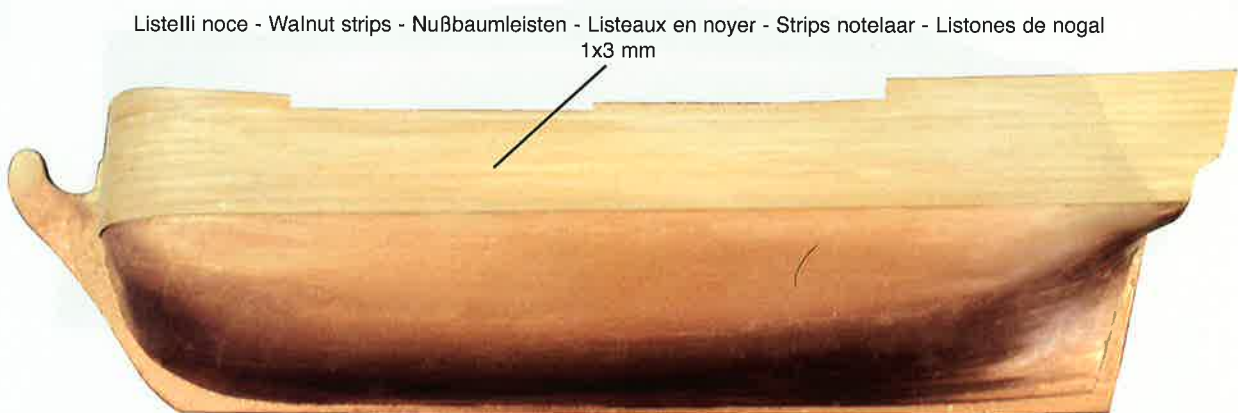

Listelli noce - Walnut strips - Nußbaumleisten - Listeaux en noyer - Strips notelaar - Listones de nogal
1x3 mm

62

Tagliare - Cut - Schneiden - Couper
Snij weg - Cortar

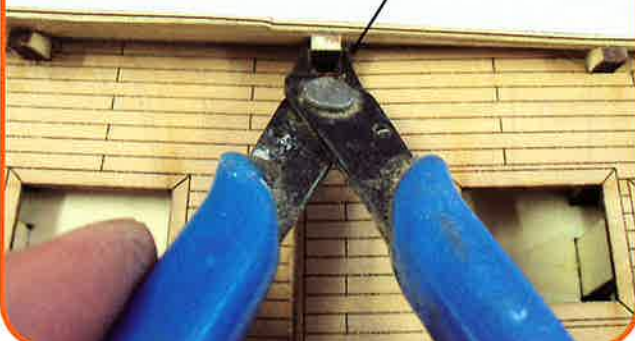

63

Carteggiare - Sand - Schleifen
Poncer - Schuur - Lijar



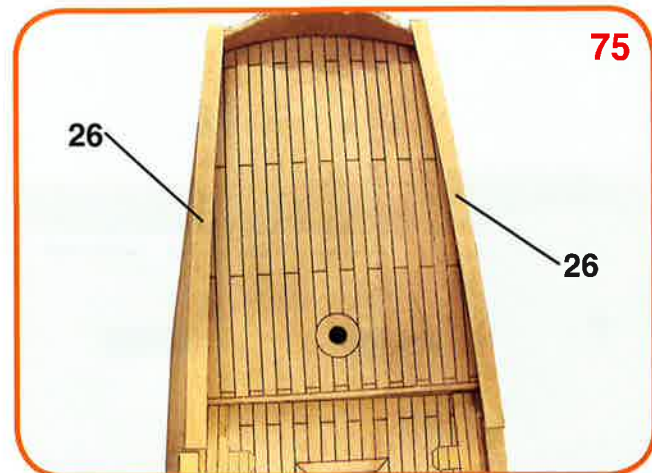
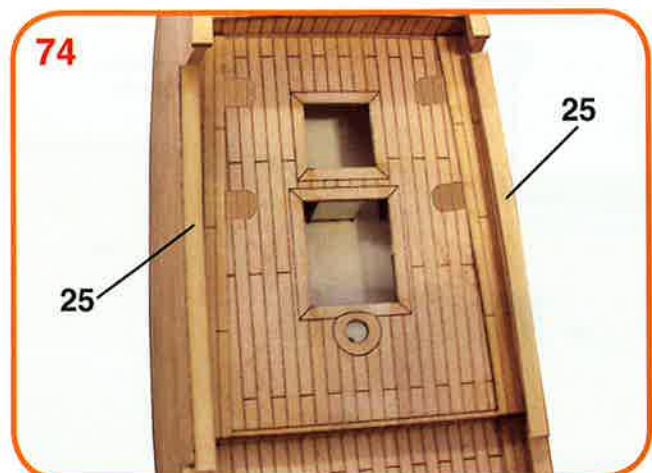
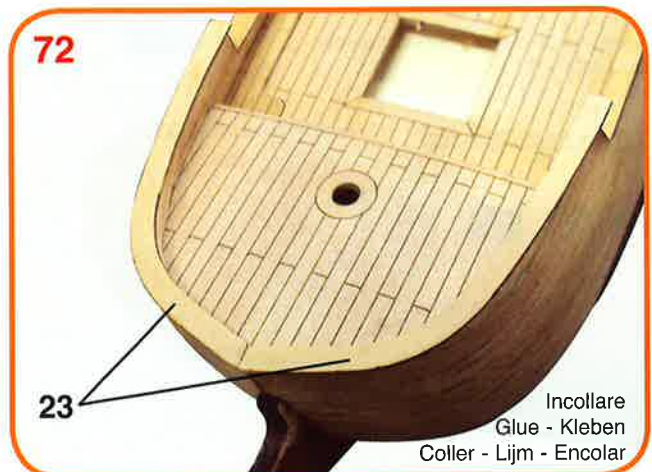
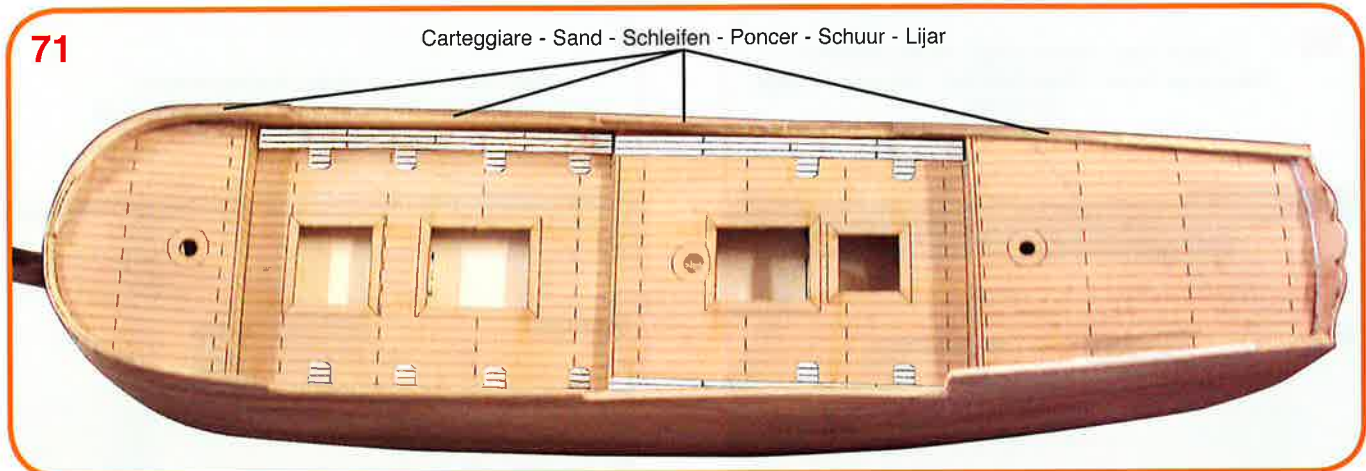
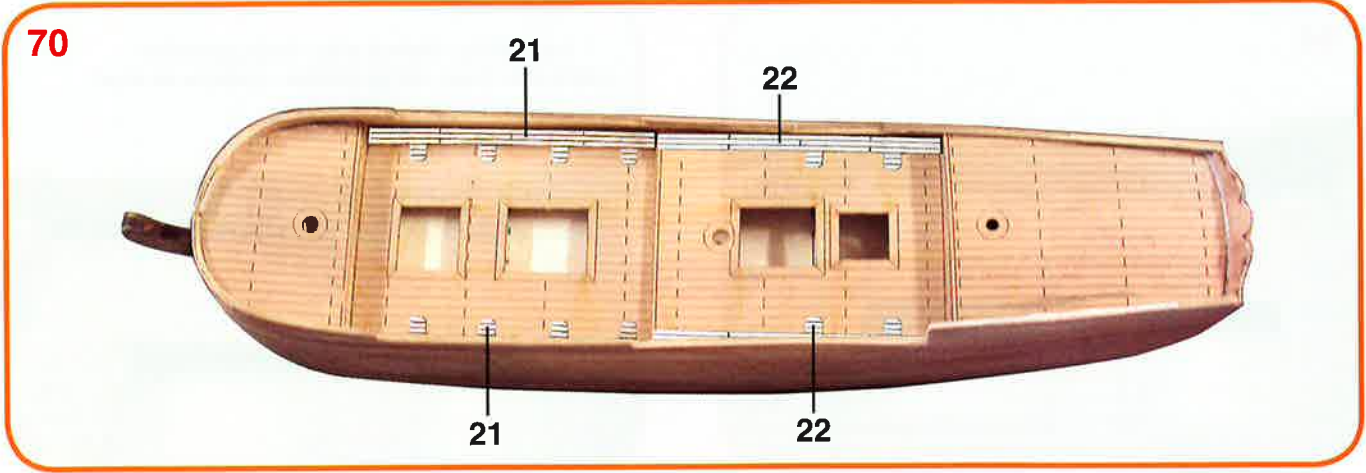

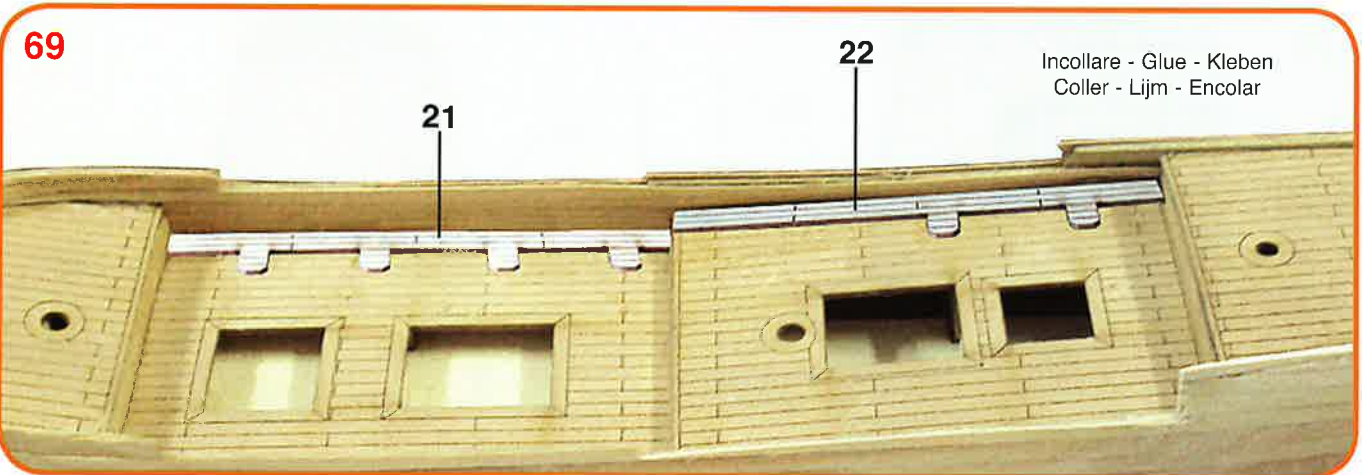
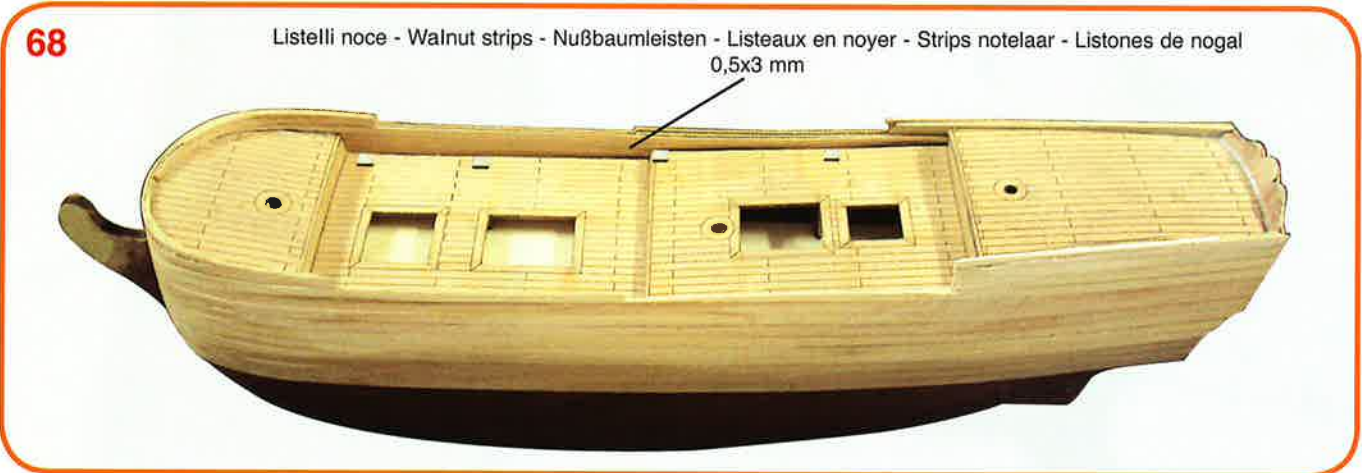
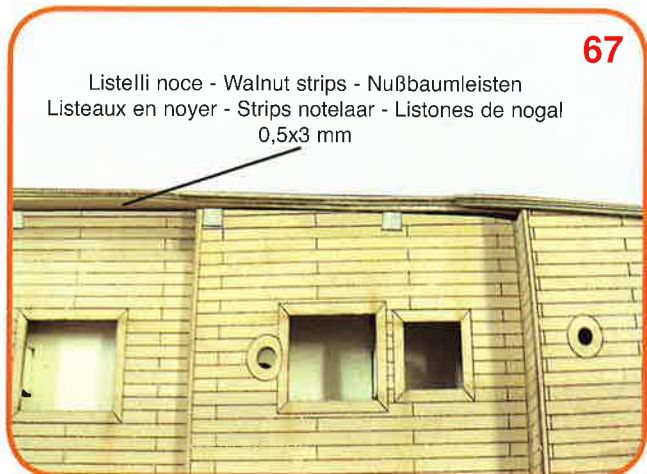
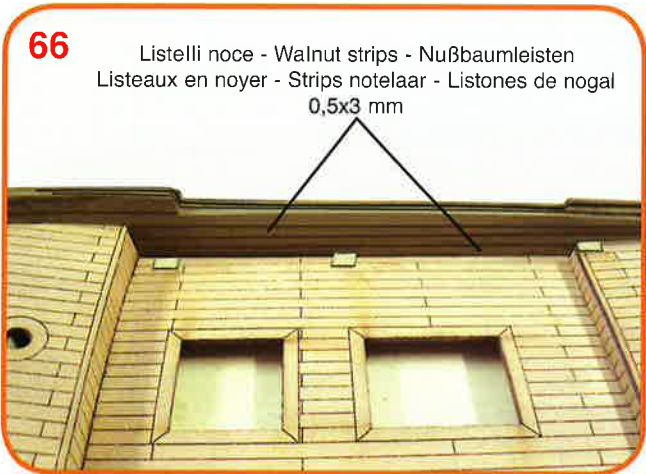
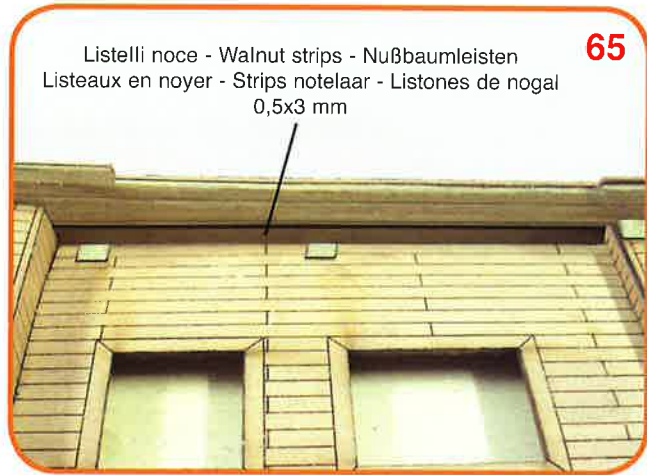

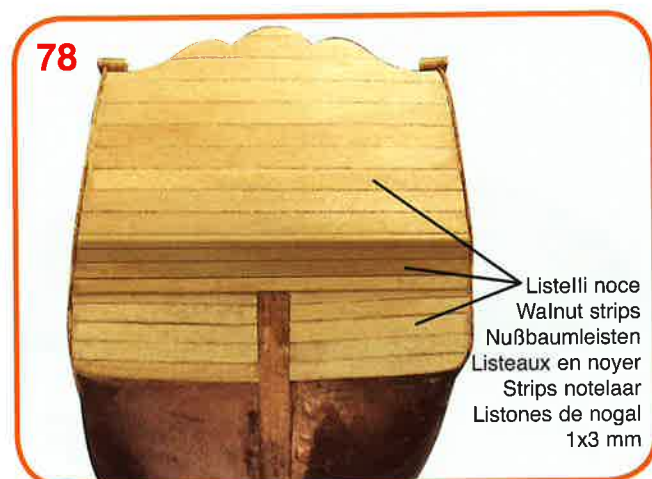
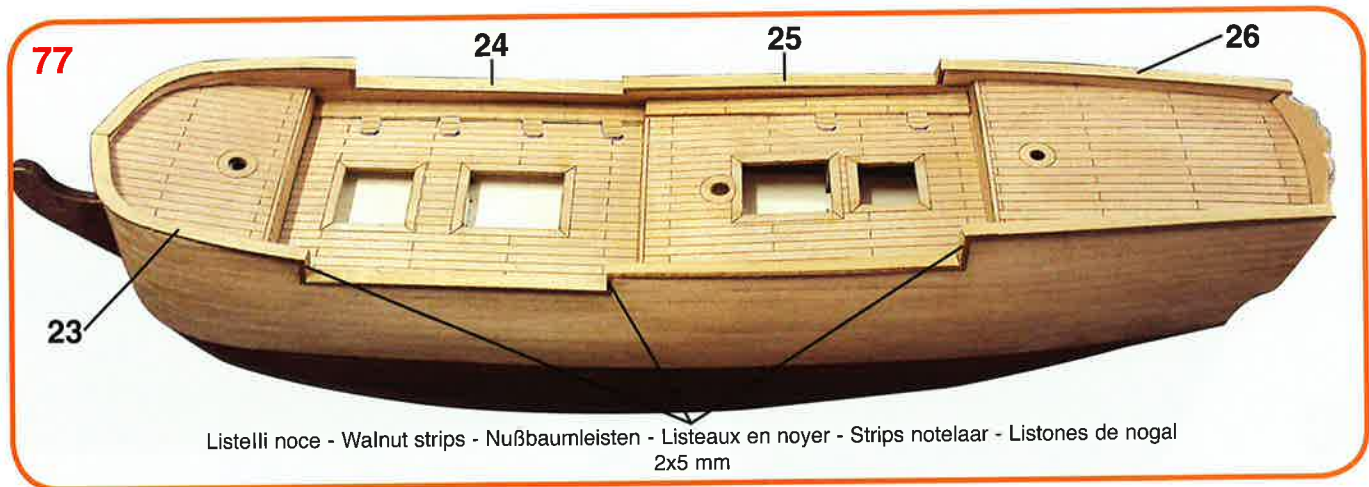
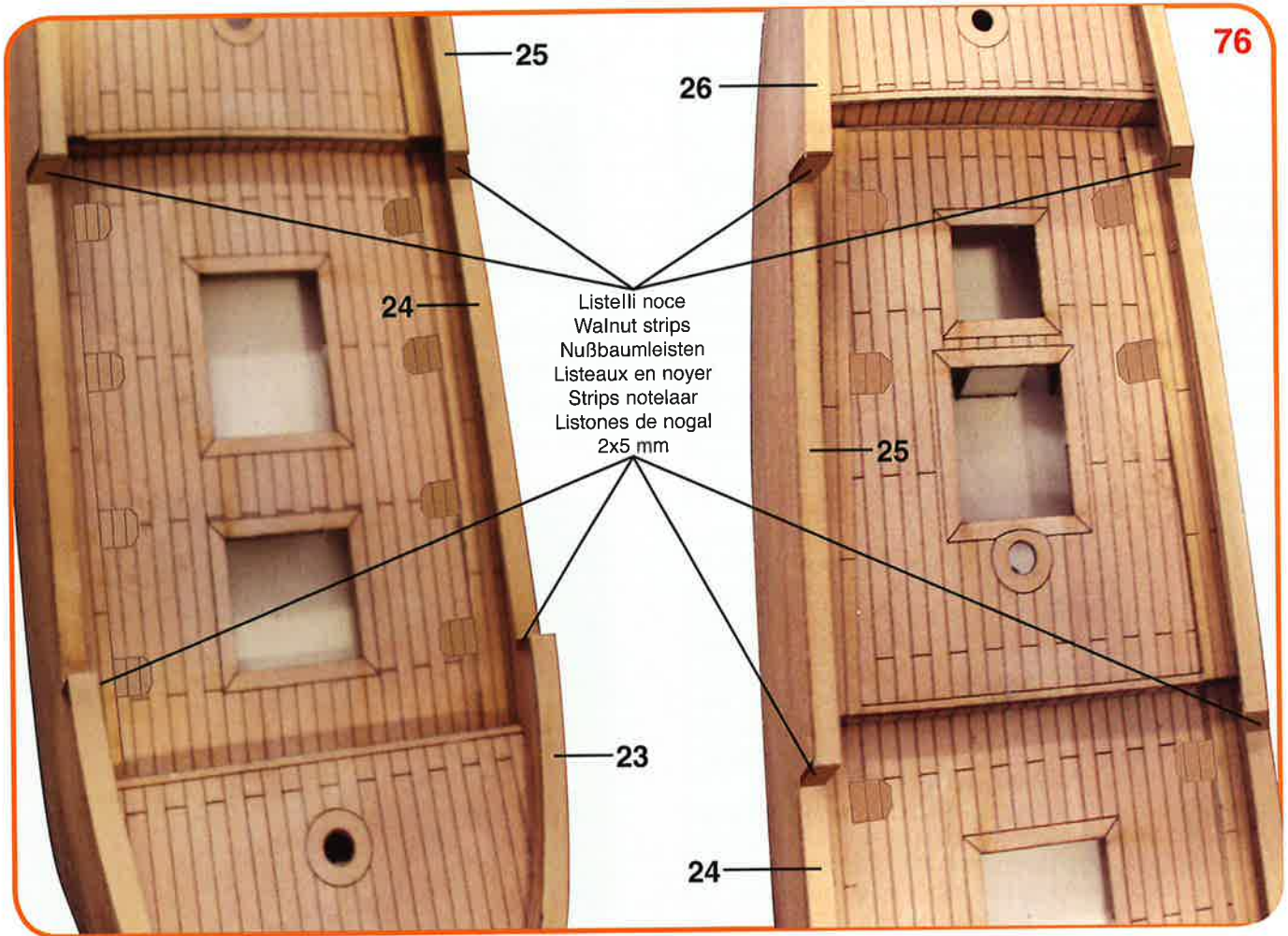

OPTIONAL

Art. 32902

Vi illustriamo come applicare le piastre di rame in legno laserinciso e verniciato a spruzzo. Le piastre sono un optional non contenuto nella scatola, ma acquistabile separatamente.

We show how to place the coppering tiles, made with laser engraved wood. The coppering material is not supplied with the kit and is optional and can be purchased separately.

Teil des Rumpfs. Auf diesen Fotos sehen Sie, wie die mit Laser eingeschnittenen, mit Spray lackierten, hölzernen Kupferplättchen befestigt werden. Diese Platten sind Extrazubehör, der nicht im Bausatz vorhanden ist, sondern separat erworben werden kann.

Le cuivre des œuvres vives du bateau (la partie immergée de la coque). Sur ces photos, nous vous illustrons comment appliquer les plaques de cuivre en bois gravées au laser et vernies avec un spray. Les plaques sont une option non contenue dans la boîte, mais achetable séparément.

Op deze foto's, verduidelijken wij u hoe de platen van koper in hout toepassen gegraveerd aan de laser en gevernist met een spray. De platen zijn niet inbegrepen in de bouwdoos, maar koopbaar afzonderlijk.

En esta foto ilustramos cómo aplicar las placas de cobre en madera grabada con el láser y pulverizada con barniz. Las placas son opcionales y no están incluidas en el contenido de la caja, sino que se compran por separado.

A



Tavola laser-incisa - Laser engraved sheet
Laser eingeschnitten - Planche laser-gravée
Laser ingesneden plank - Tabla laser grabó

B

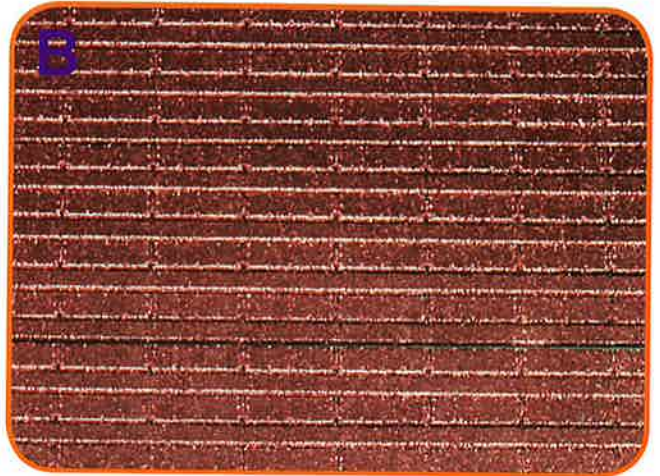

Incollare - Glue - Kleben
Coller - Lijm - Encolar

C

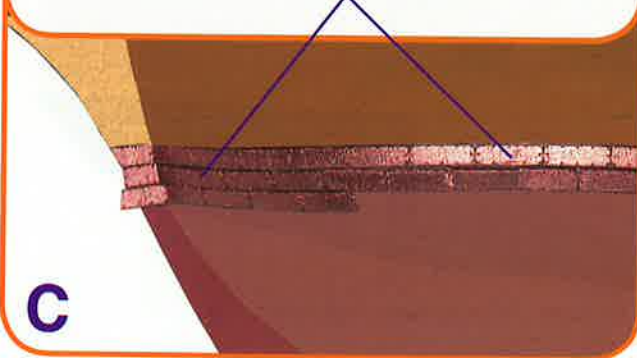

Incollare - Glue - Kleben
Coller - Lijm - Encolar

D

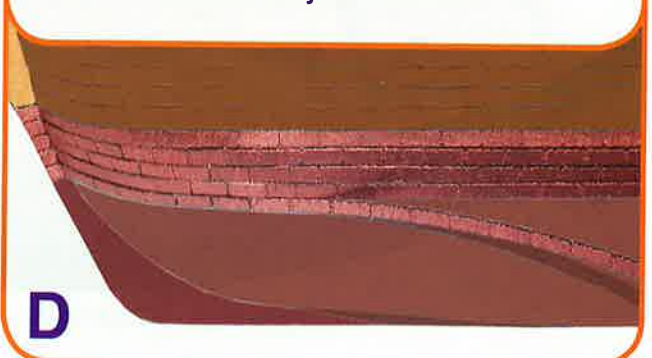

E



F



80

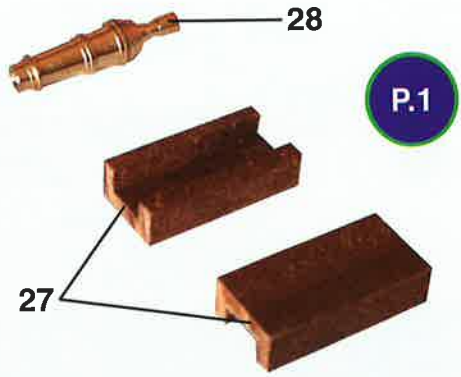

81

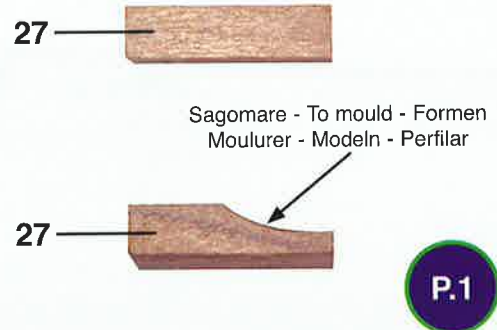

82

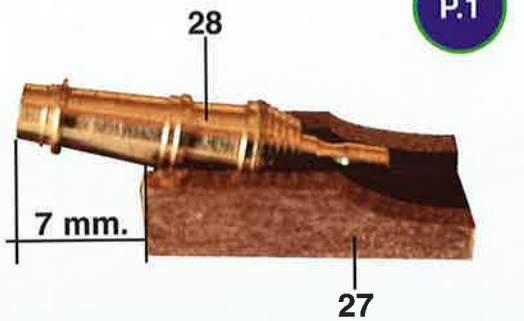

Incollare - Glue - Kleben - Coller - Lijm - Encolar

83
 Segnare la posizione della canna con la matita
 Mark the barrel position with a pencil with
 Markieren Sie die Position der Kanone mit einem Bleistift
 Marquez la position du canon avec un crayon
 Markeer de positie vat met kanon
 Marque la posición de cañones con un lápiz



84

Segnare la posizione della canna con la matita
 Mark the barrel position with a pencil with
 Markieren Sie die Position der Kanone mit einem Bleistift
 Marquez la position du canon avec un crayon
 Markeer de positie vat met kanon
 Marque la posición de cañones con un lápiz

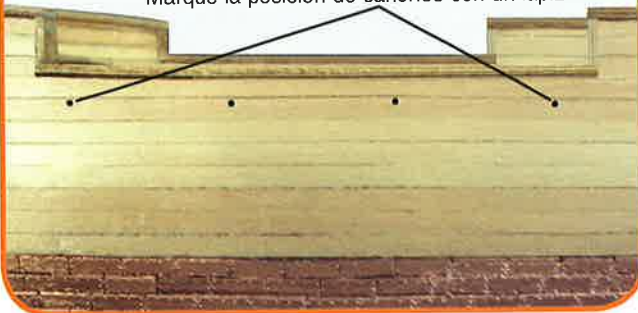

85
 Segnare la posizione della canna con la matita
 Mark the barrel position with a pencil with
 Markieren Sie die Position der Kanone mit einem Bleistift
 Marquez la position du canon avec un crayon
 Markeer de positie vat met kanon
 Marque la posición de cañones con un lápiz

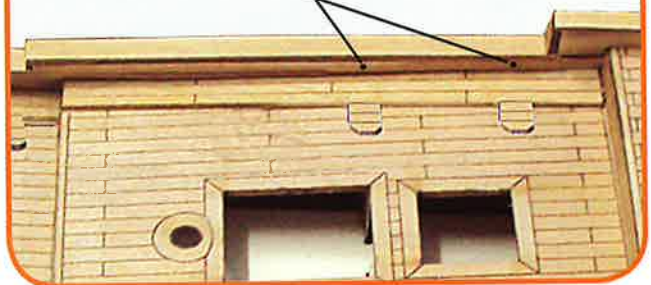

86

Segnare la posizione della canna con la matita
 Mark the barrel position with a pencil with
 Markieren Sie die Position der Kanone mit einem Bleistift
 Marquez la position du canon avec un crayon
 Markeer de positie vat met kanon
 Marque la posición de cañones con un lápiz



87
 Forare - Drill - Bohren
 Forer - Bohr - Perforar
 ø 6 mm.

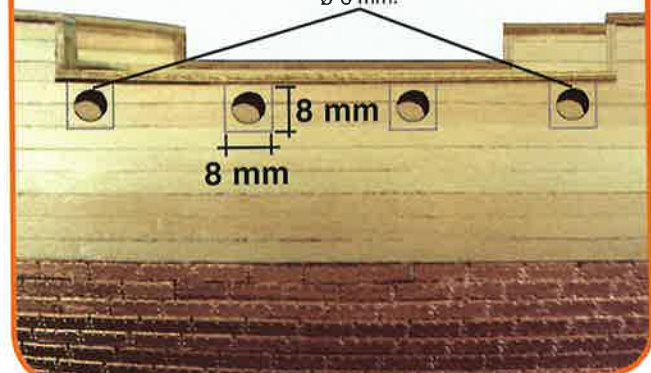

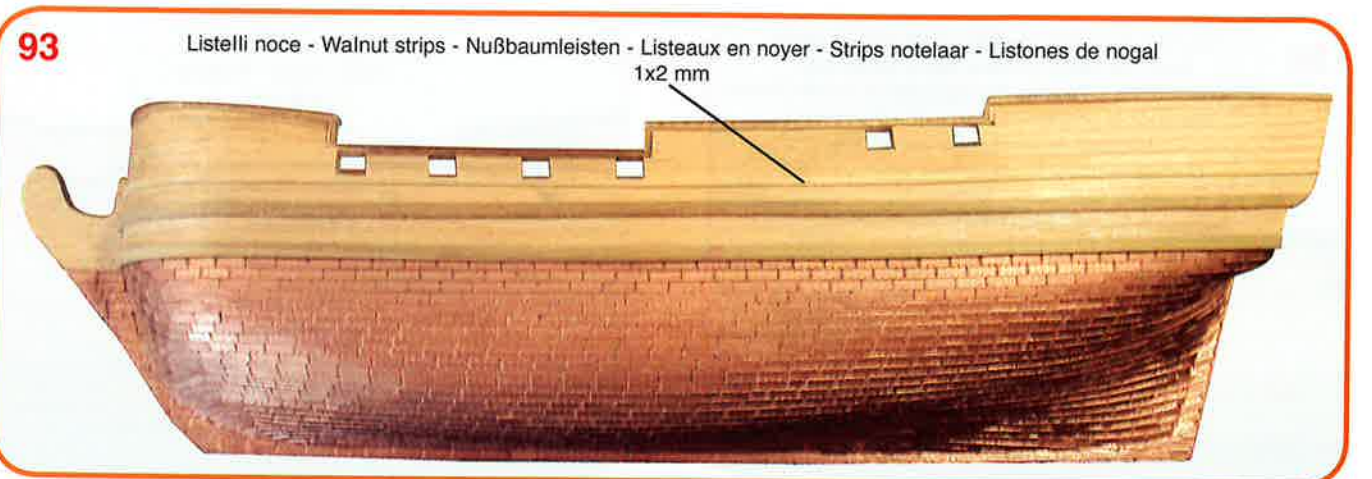
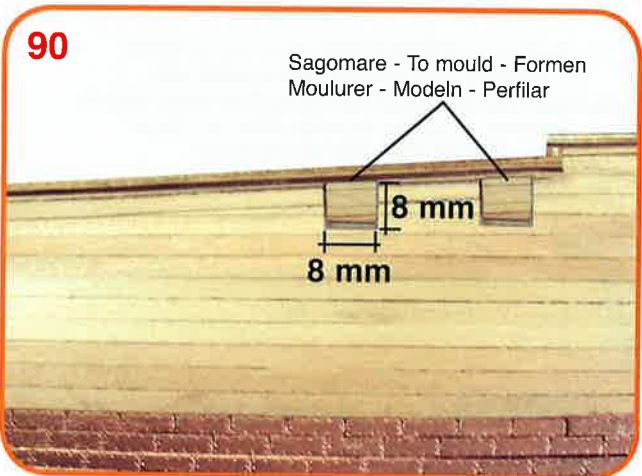
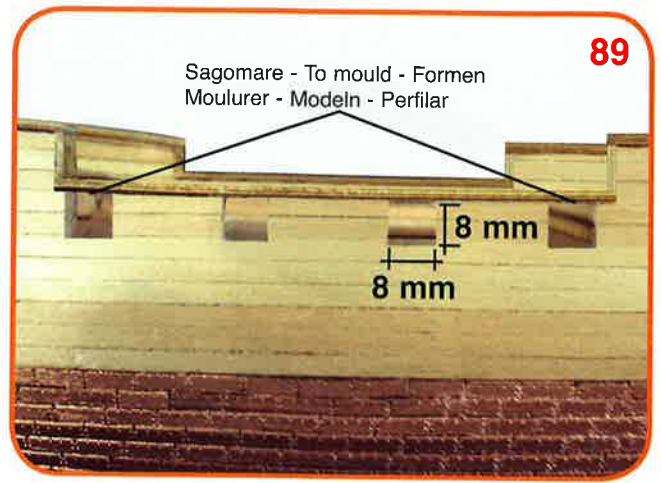
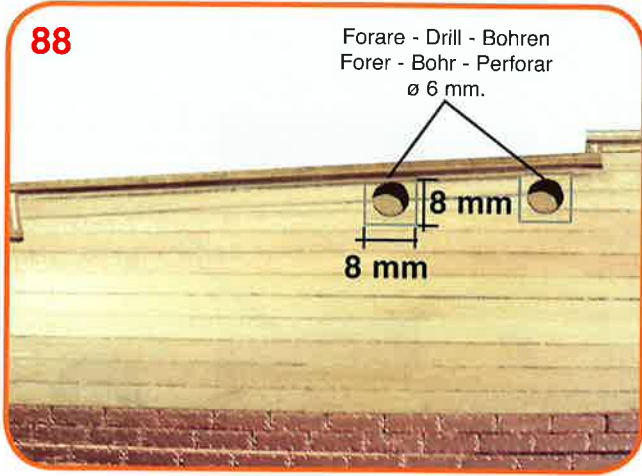

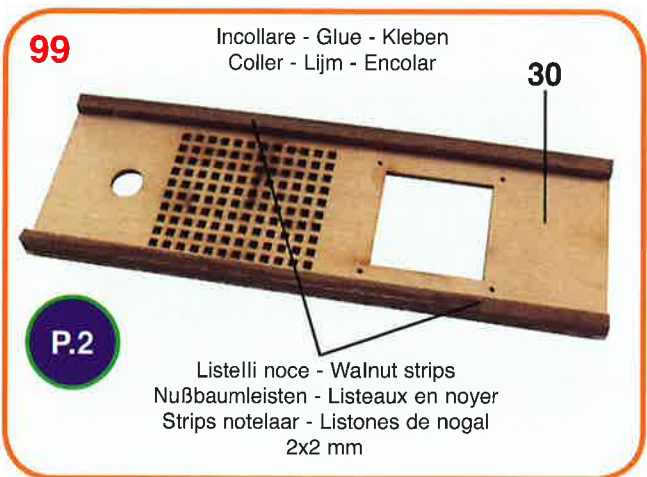
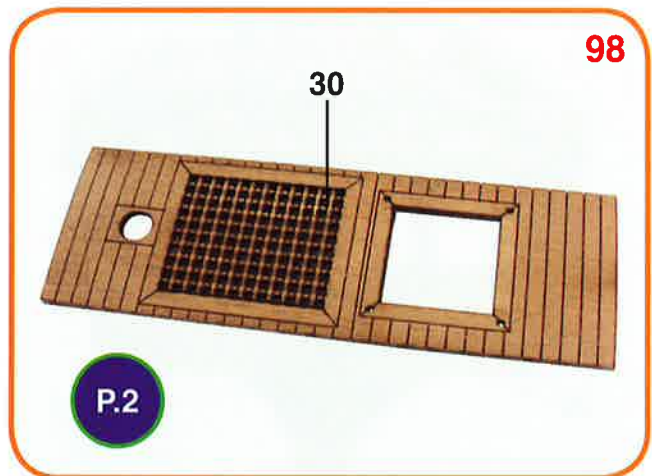
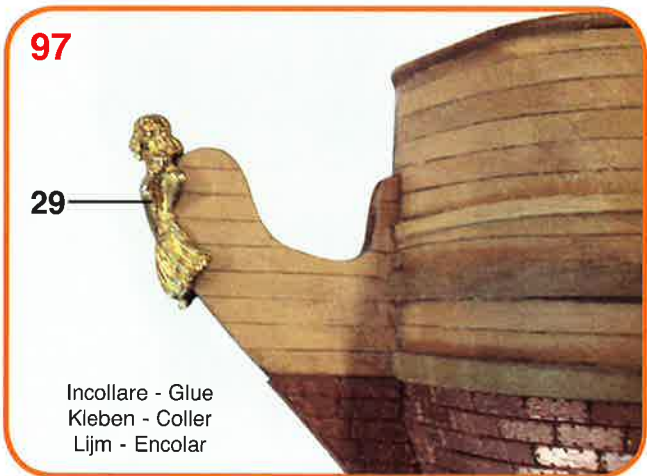
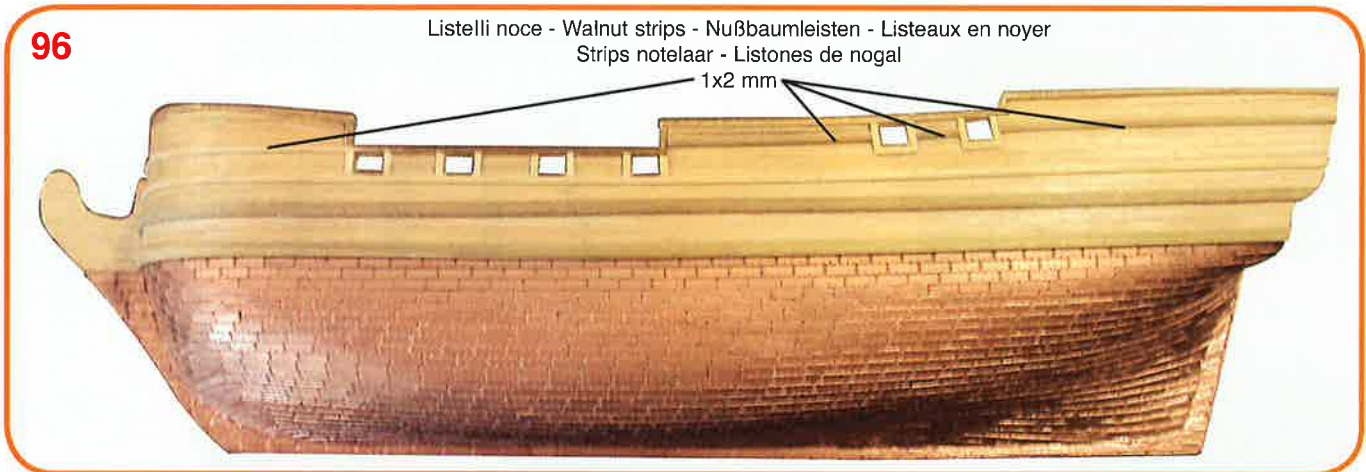
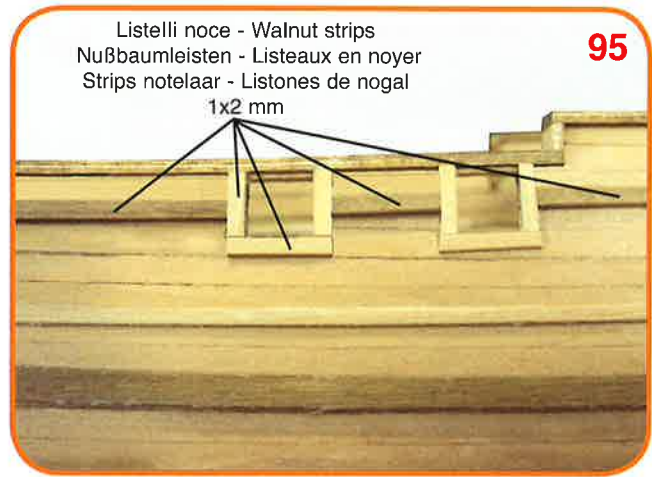
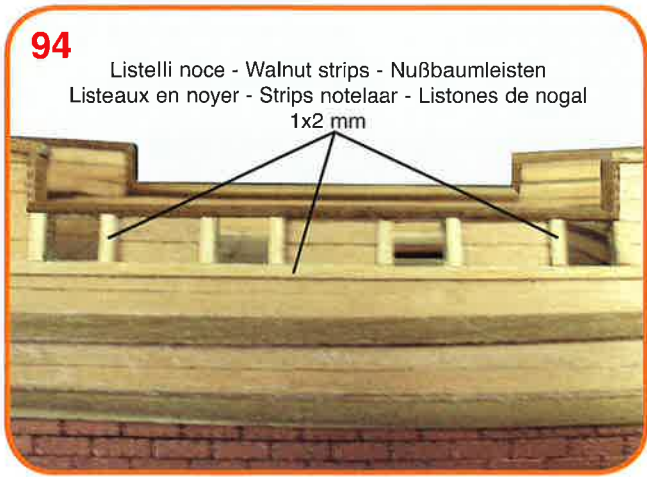

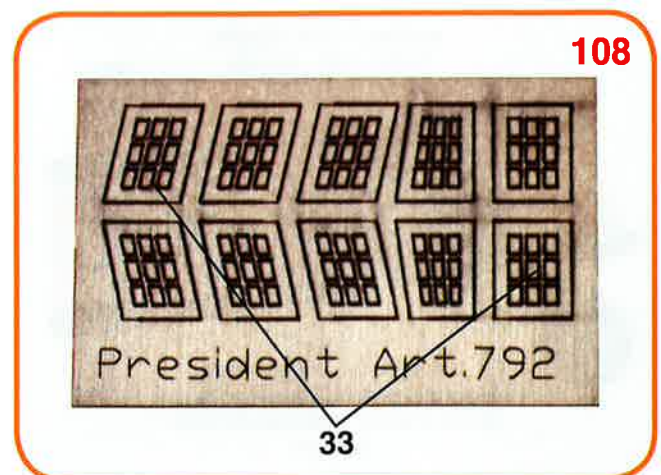
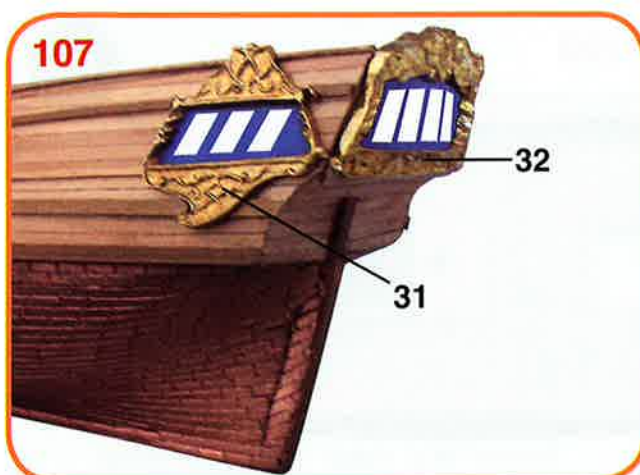
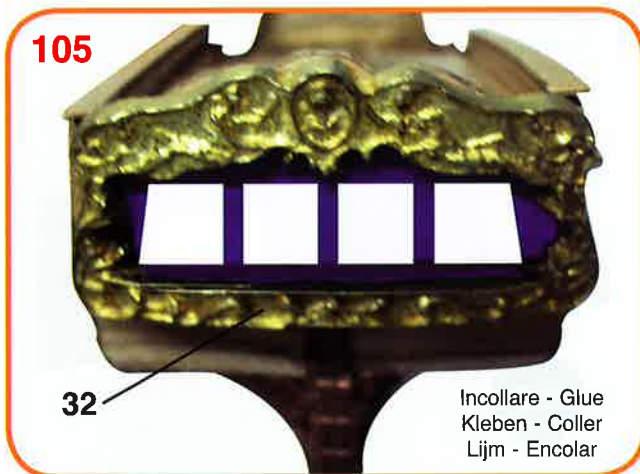
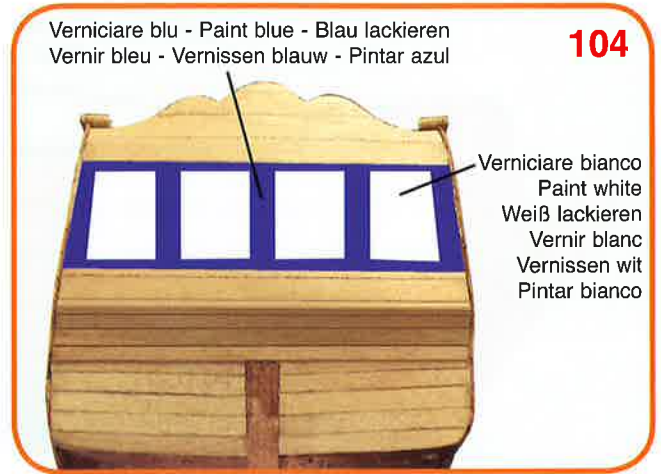
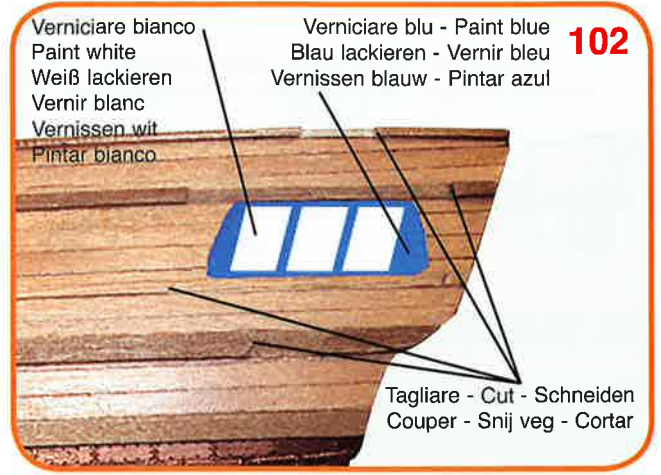
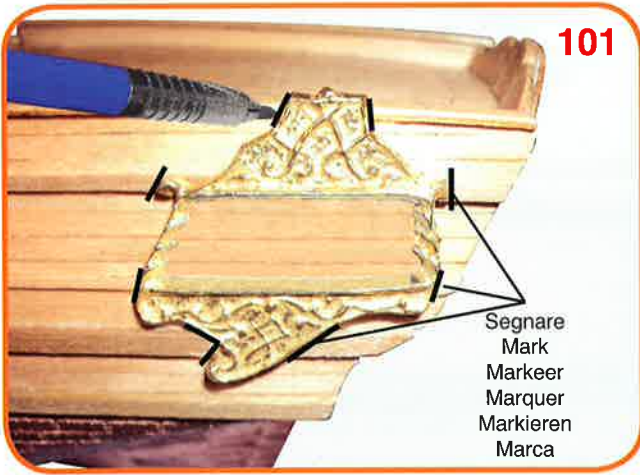

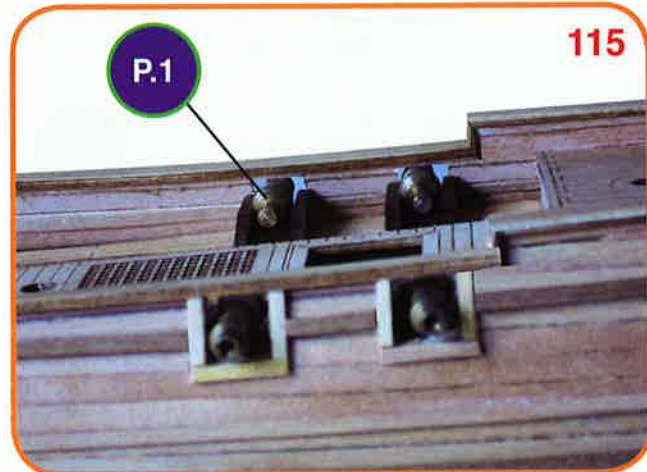
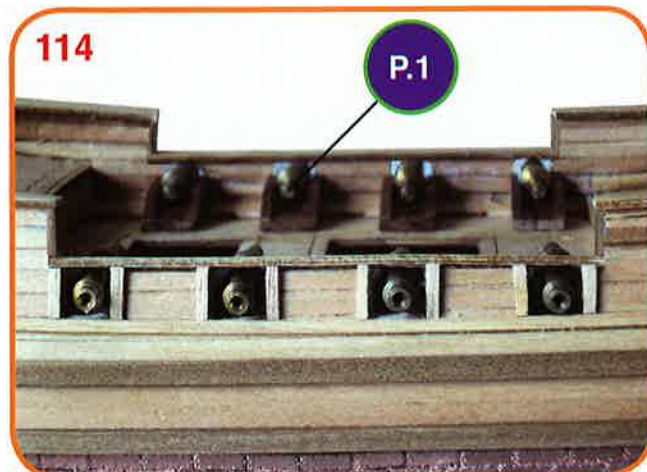
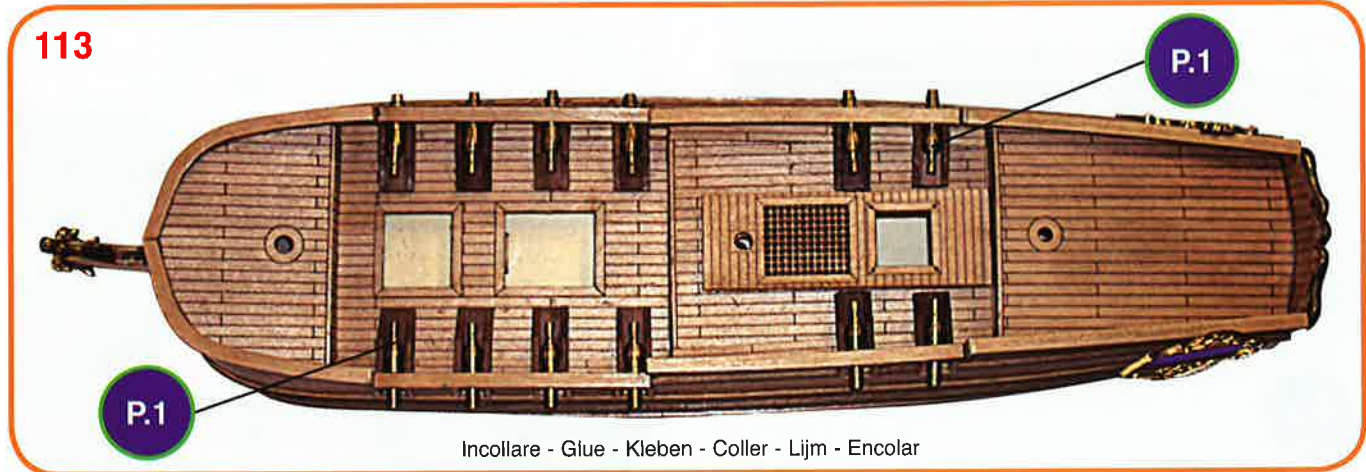
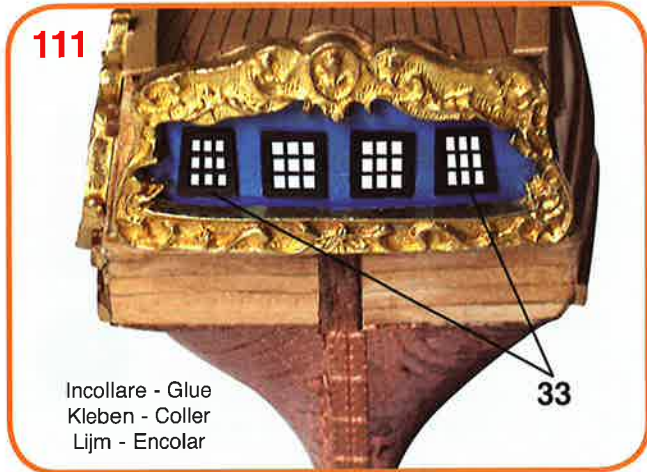
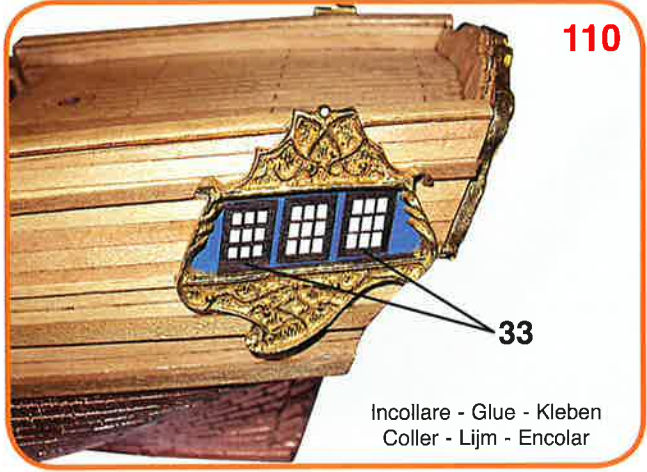
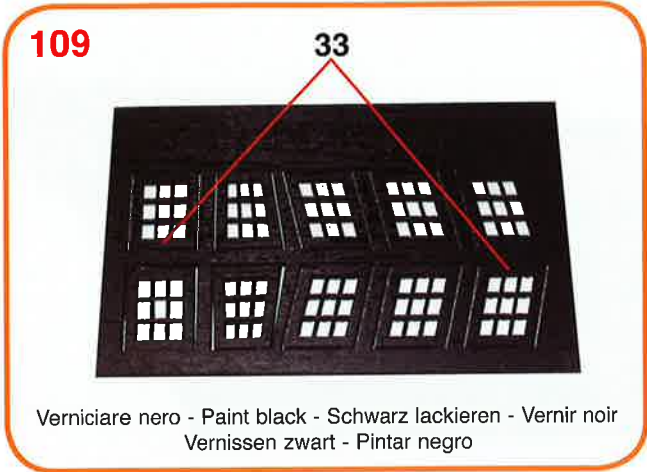

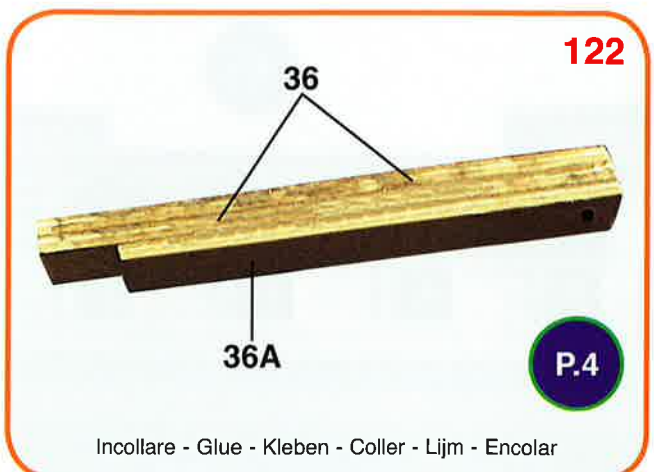
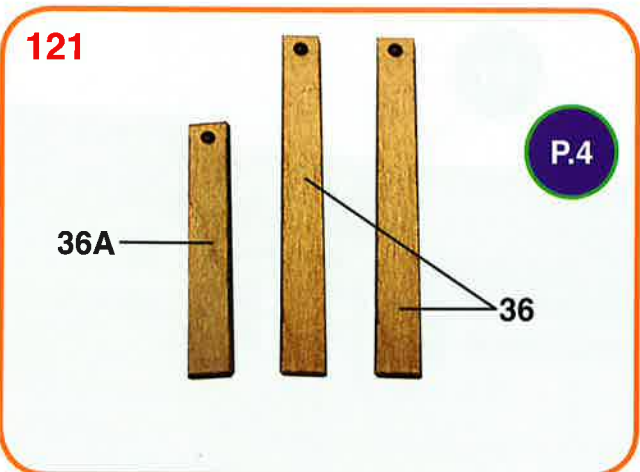
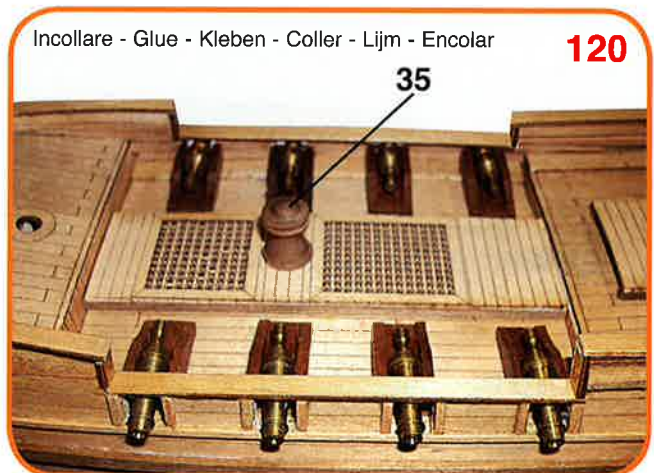
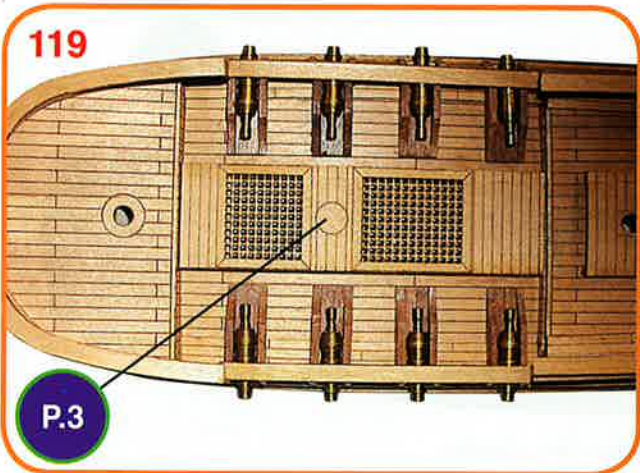
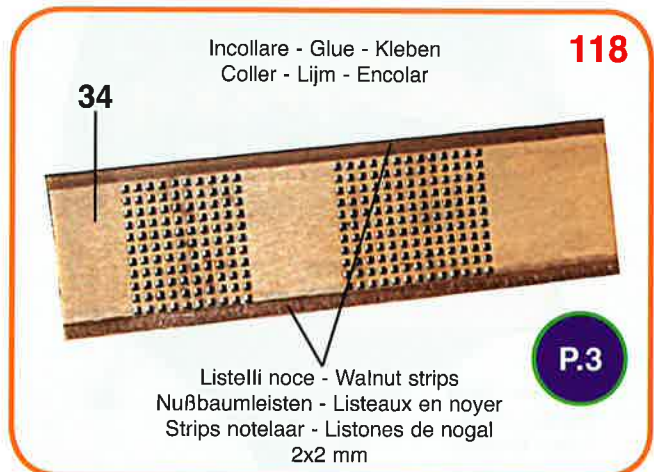
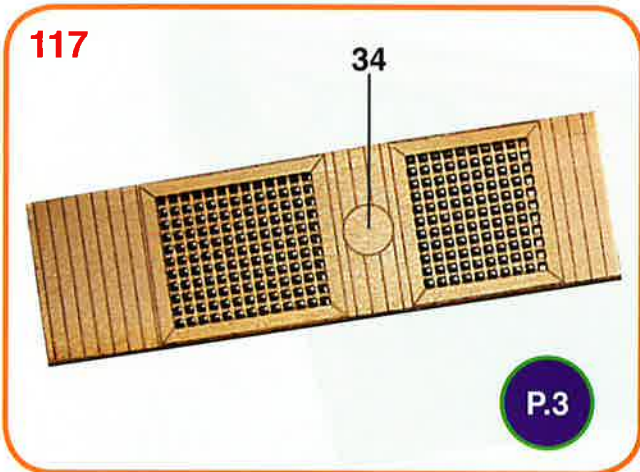

123

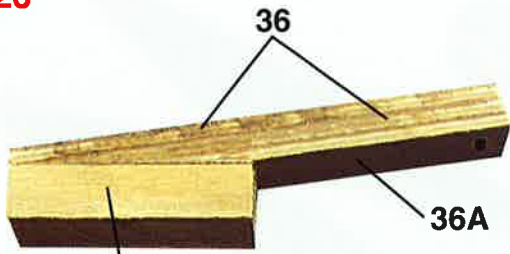

Listelli noce - Walnut strips
 Nußbaumleisten - Listeaux en noyer
 Strips notelaar - Listones de nogal
 4x4x15 mm

P.4

124

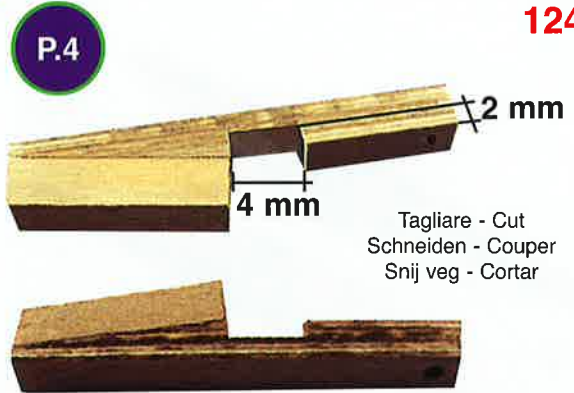

Tagliare - Cut
 Schneiden - Couper
 Snij weg - Cortar

P.4

125



Verniciare nero - Paint black - Schwarz lackieren
 Vernir noir - Vernissen zwart - Pintar negro



P.4

126

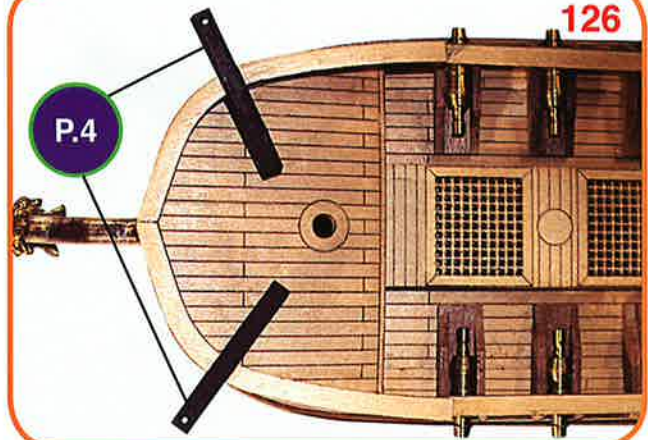

P.4

127



P.4

Montanti scala - Ladder sides - Treppenholme
 Echelles - Ladder zijden - Lados de escala
 2x3x30 mm

128



P.5

Listelli noce
 Walnut strips
 Nußbaumleisten
 Listeaux en noyer
 Strips notelaar
 Listones de nogal
 1x3x12 mm

129



Incollare - Glue - Kleben
 Coller - Lijm - Encolar

P.5

130



P.5

131

Carteggiare
Sand
Schleifen
Poncer
Schuur
Lijar



132

P.6



Verniciare nero - Paint black
Schwarz lackieren - Vernir noir
Vernissen zwart - Pintar negro

133

P.6

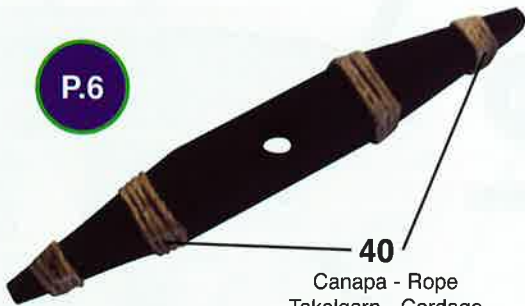

Canapa - Rope
Takelgarn - Cordage
Touw - Hilo
ø 0,50 mm

134

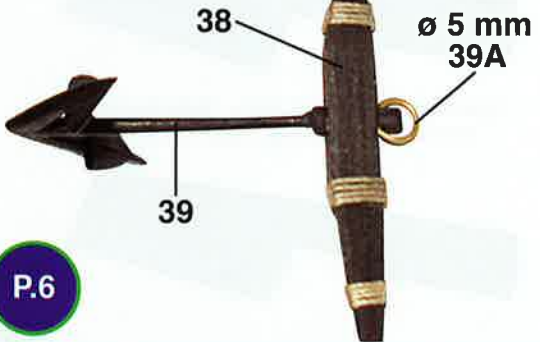

135

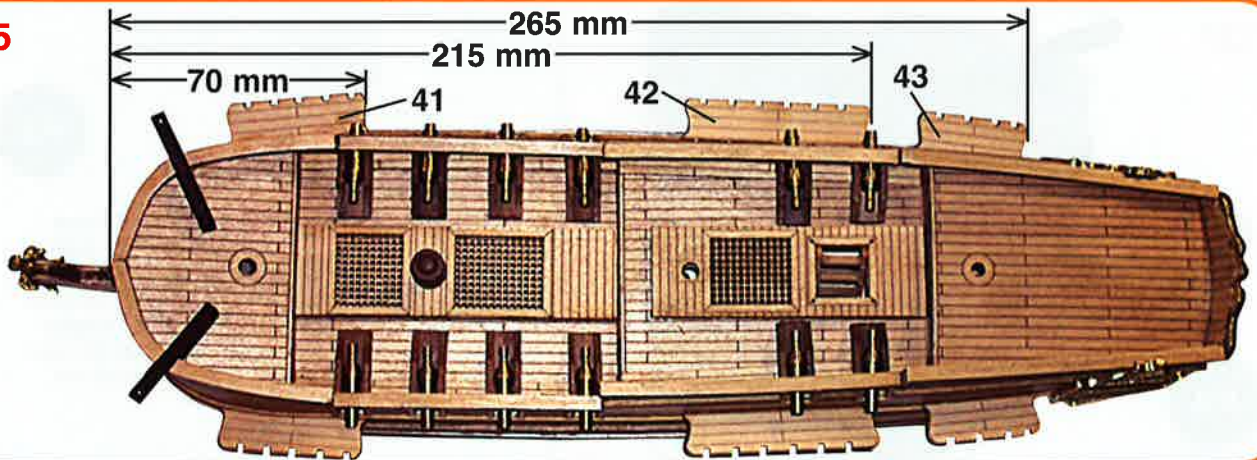

136



Incollare - Glue - Kleben - Coller - Lijm - Encolar

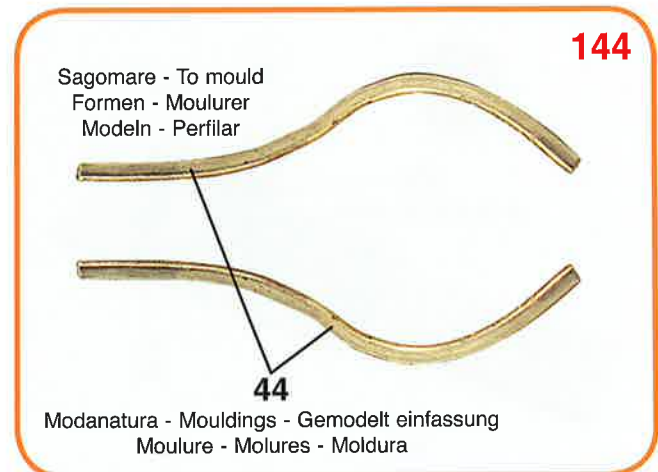
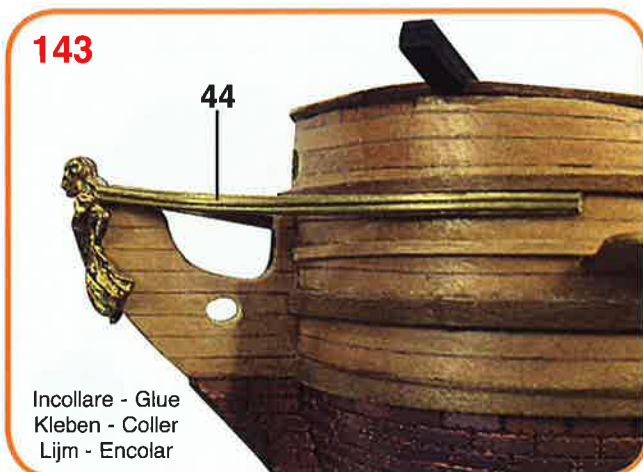
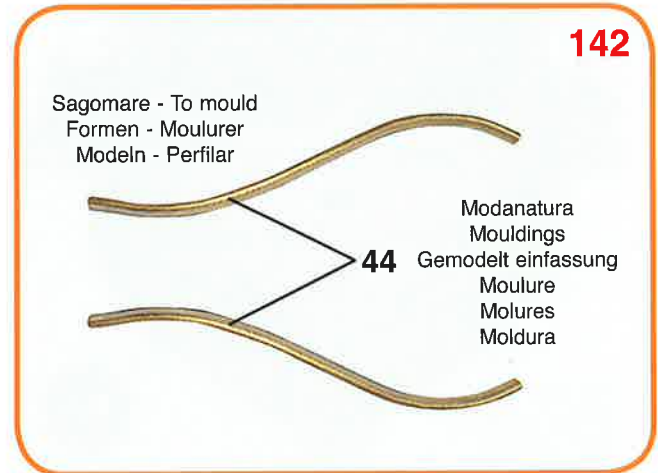
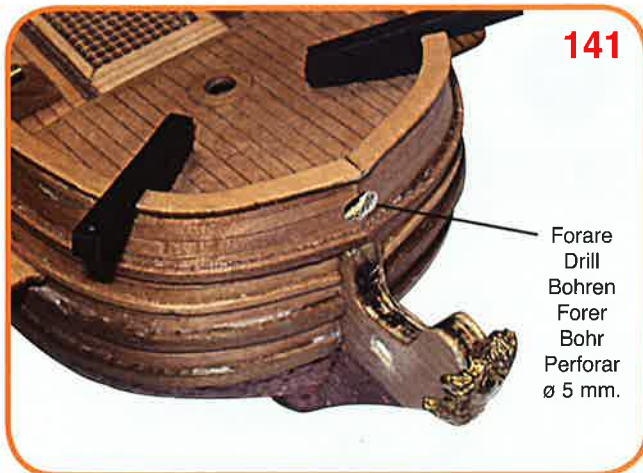
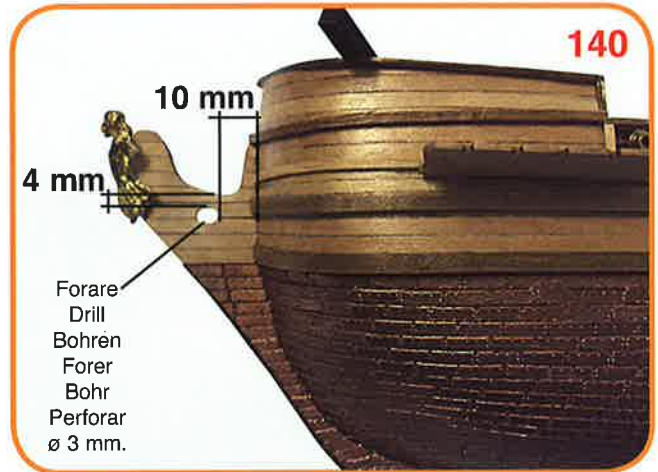
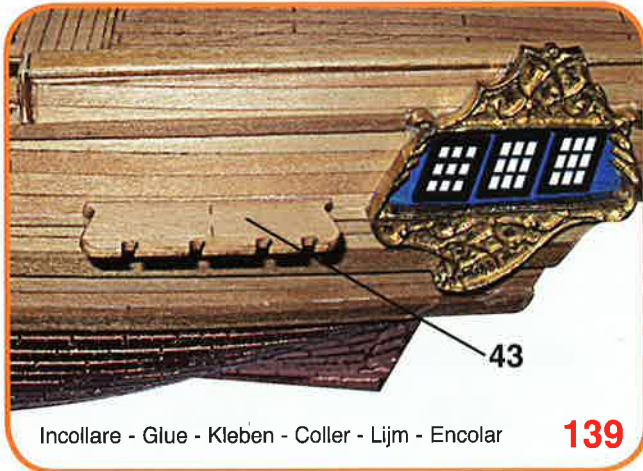
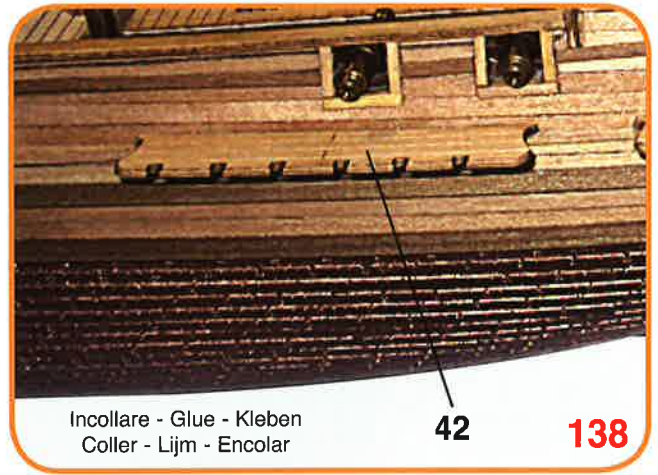

145

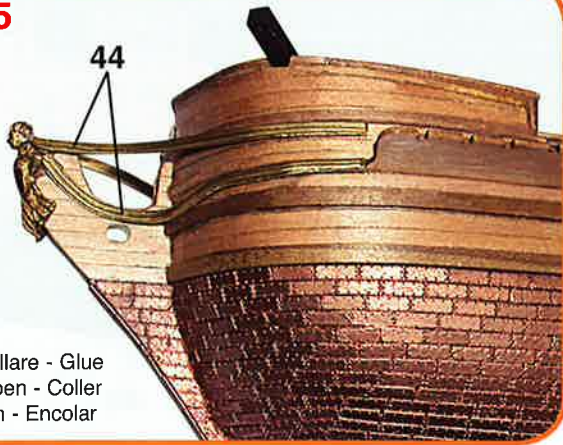

Incollare - Glue
Kleben - Coller
Lijm - Encolar

146

Sagomare - To mould
Formen - Moulurer
Modeln - Perfilar

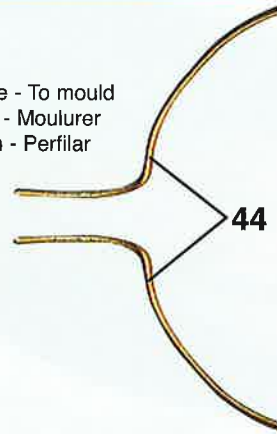

Modanatura
Mouldings
Gemodelt einfassung
Moulure
Molures
Moldura

147

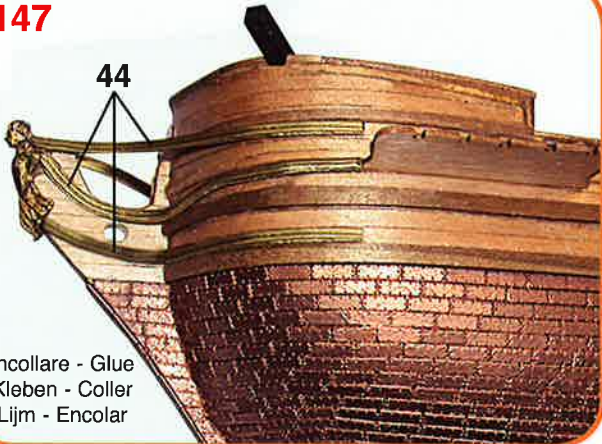

Incollare - Glue
Kleben - Coller
Lijm - Encolar

148

P.7

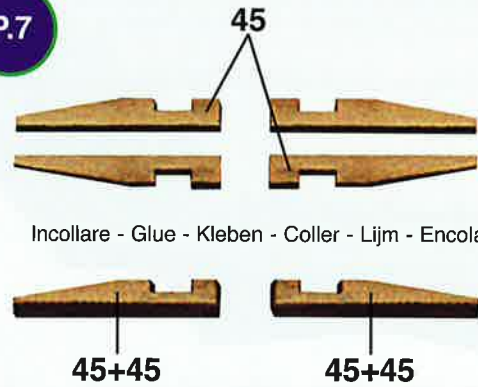

Incollare - Glue - Kleben - Coller - Lijm - Encolar

149



Incollare - Glue
Kleben - Coller
Lijm - Encolar

P.7

150

P.8

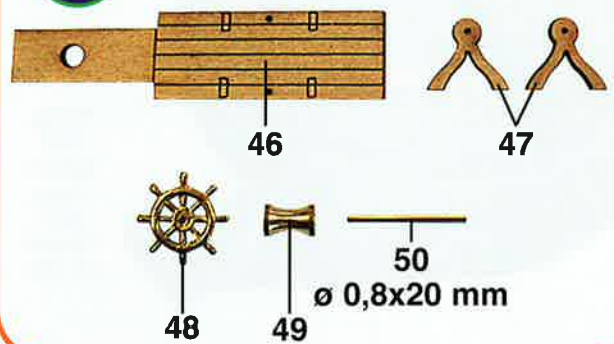

151

P.8

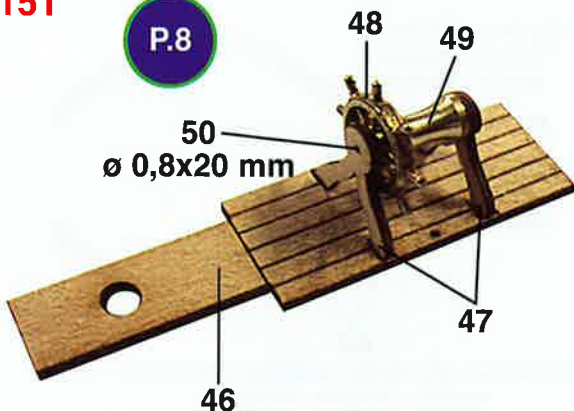

Incollare - Glue - Kleben - Coller - Lijm - Encolar

152



P.8

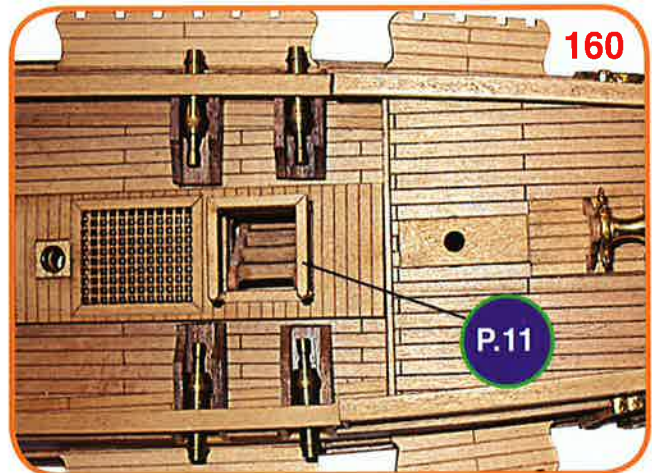
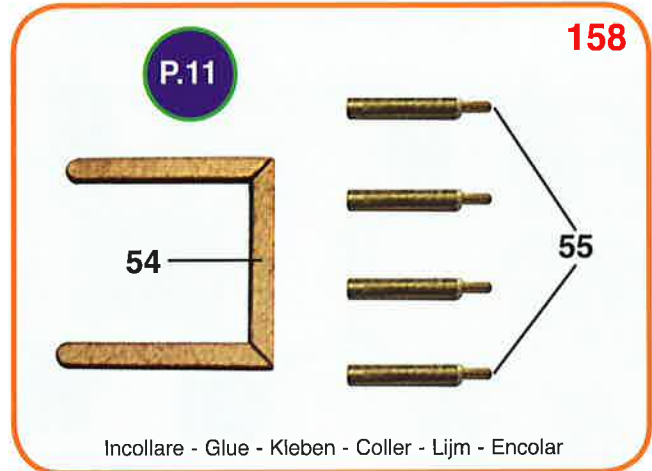
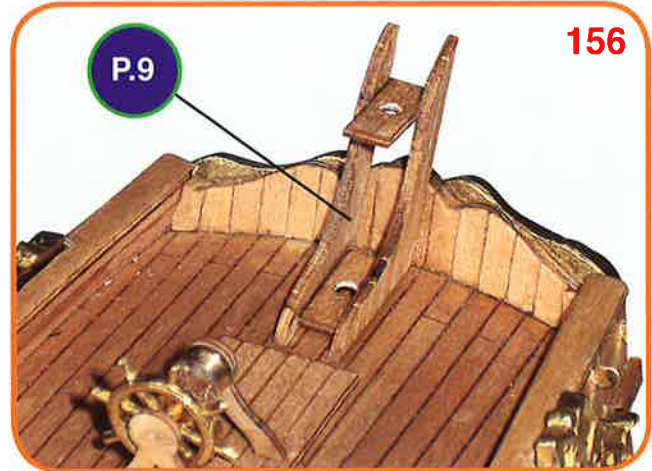
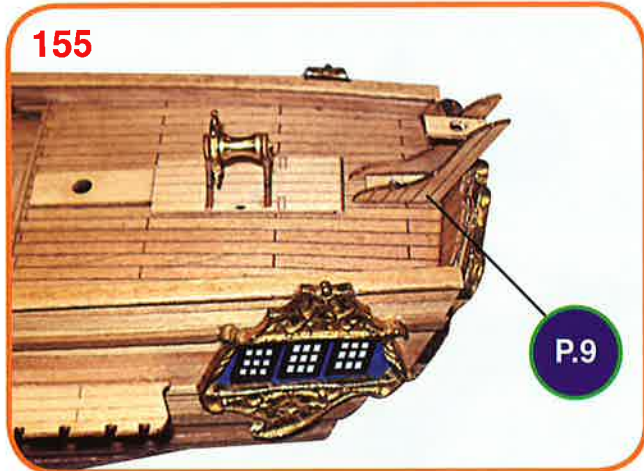
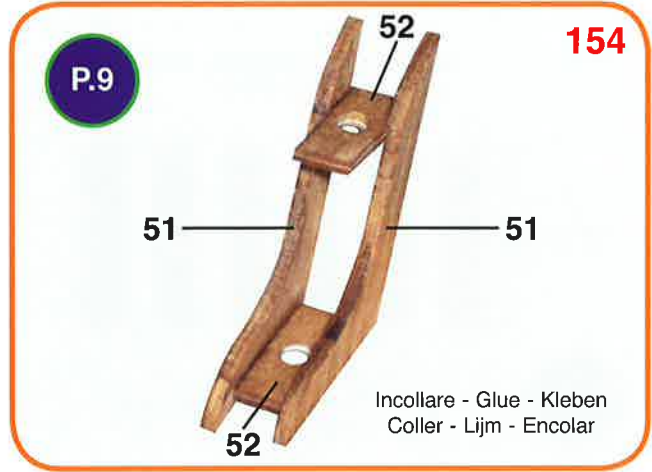
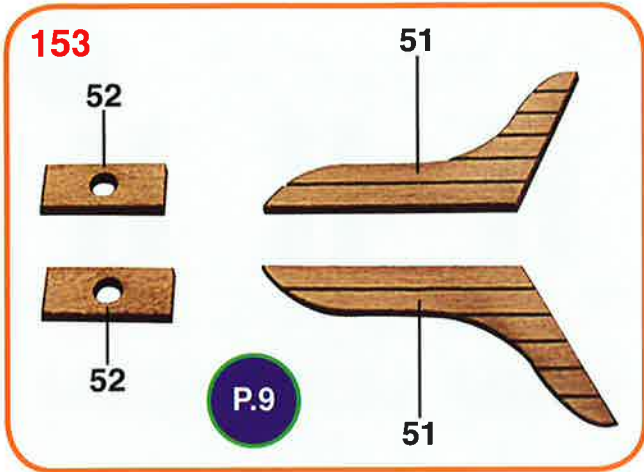

161

Tagliare - Cut - Schneiden - Couper
Snij weg - Cortar

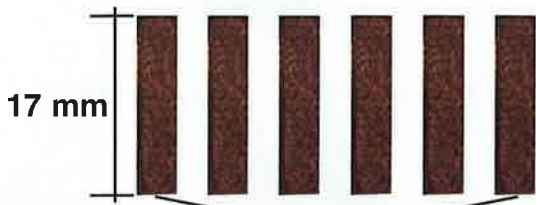

P.12
Listelli noce - Walnut strips
Nußbaumleisten - Listeaux en noyer
Strips notelaar - Listones de nogal
3x3 mm

162

Sagomare - To mould - Formen
Moulerer - Modeln - Perfilar

P.12



Listelli noce - Walnut strips - Nußbaumleisten - Listeaux en noyer
Strips notelaar - Listones de nogal
3x3 mm

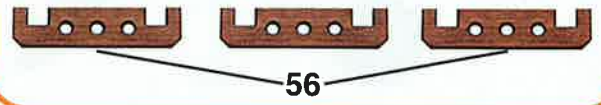

163



Listelli noce - Walnut strips - Nußbaumleisten
Listeaux en noyer - Strips notelaar
Listones de nogal
3x3 mm

P.12

Incollare - Glue - Kleben - Coller - Lijm - Encolar

Incollare - Glue - Kleben - Coller - Lijm - Encolar

164



165

Incollare - Glue - Kleben - Coller - Lijm - Encolar



Incollare - Glue - Kleben - Coller - Lijm - Encolar

166

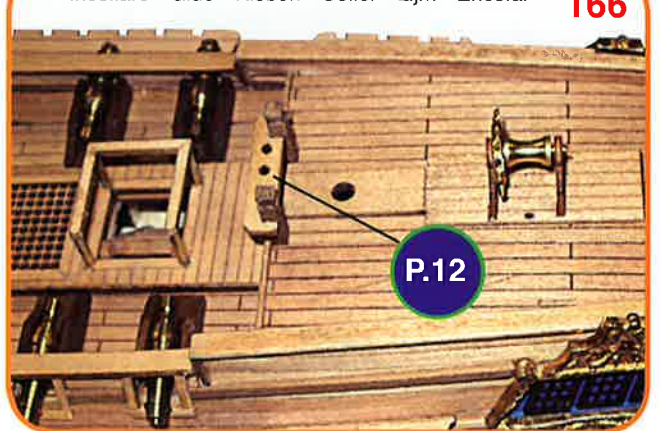

167

P.12

P.12

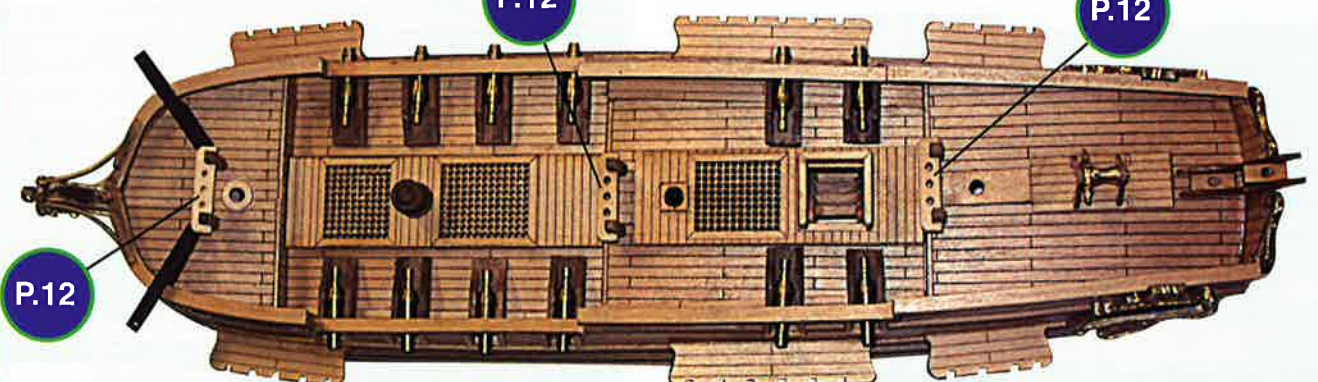

168

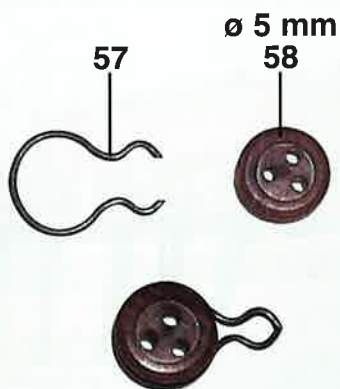

P.13

169

P.13

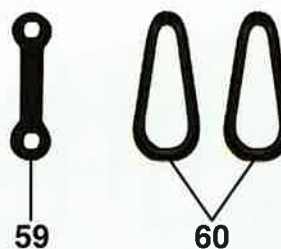

170

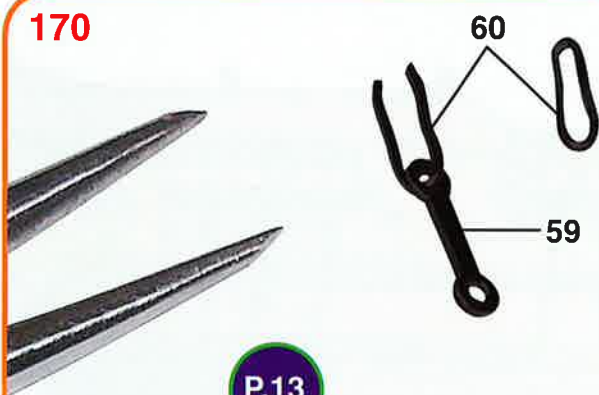

P.13

171

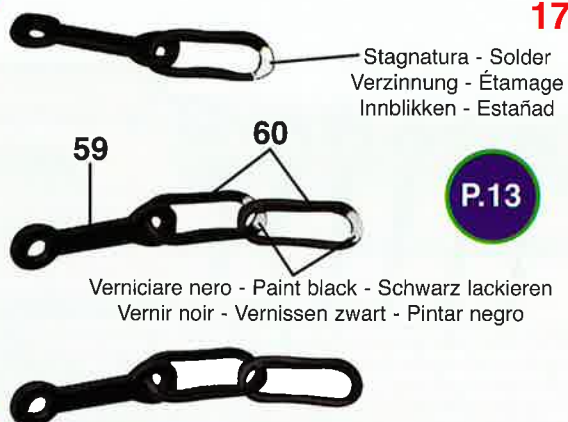

172

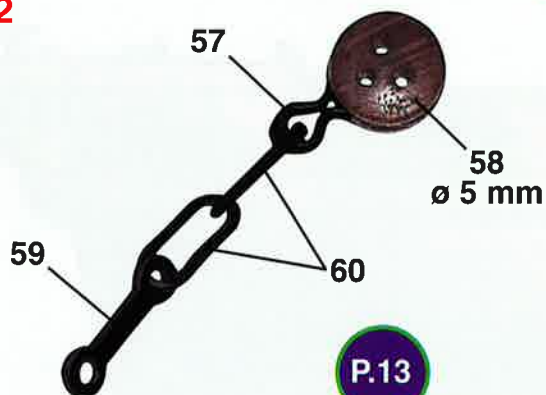

173

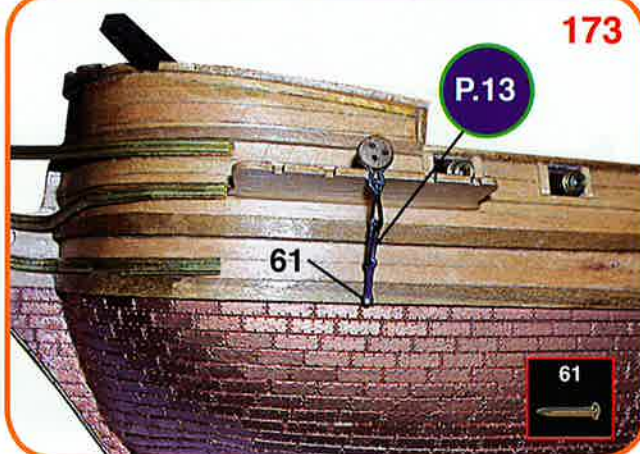

174



175

Listelli noce - Walnut strips - Nußbaumleisten
Listeaux en noyer - Strips notelaar - Listones de nogal
1x1 mm



Verniciare rosso - Paint red - Rot lackieren - Vernir rouge
Vernissen rood - Pintar rojo

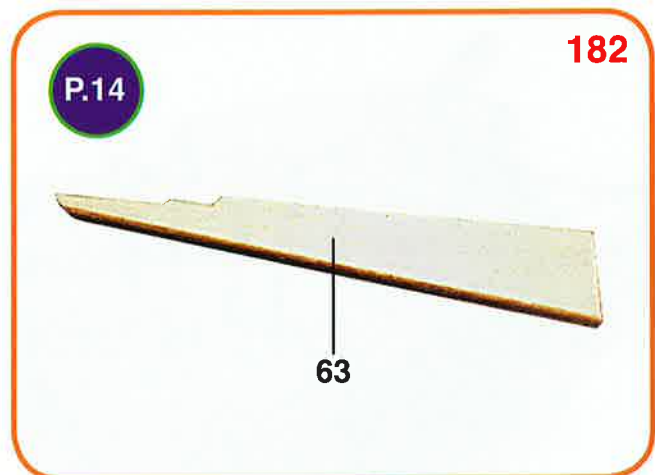
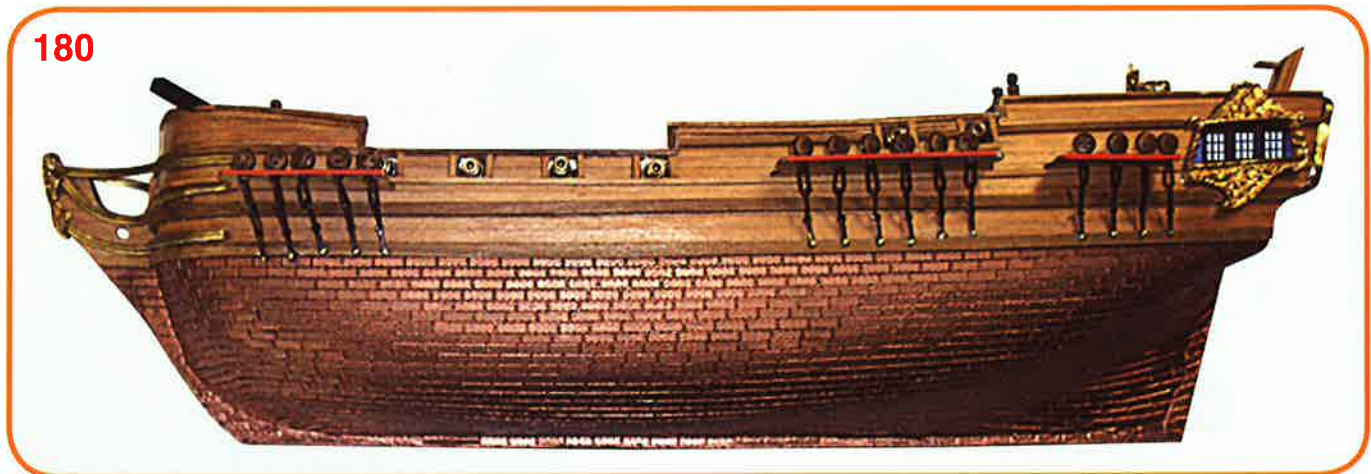
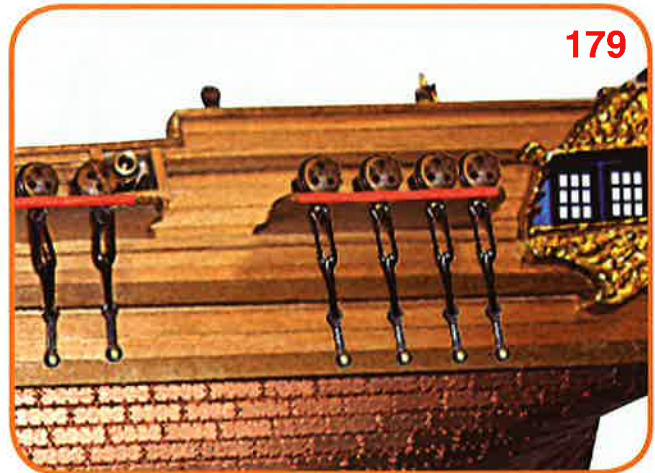
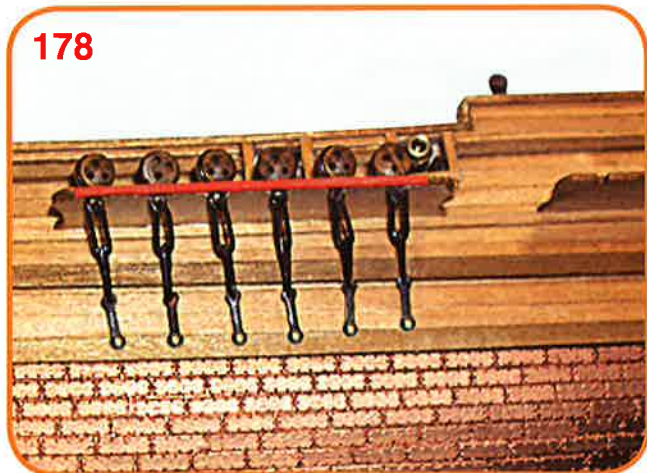
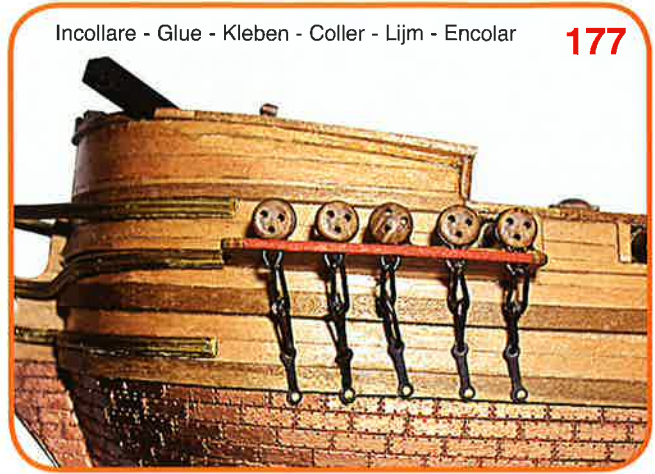
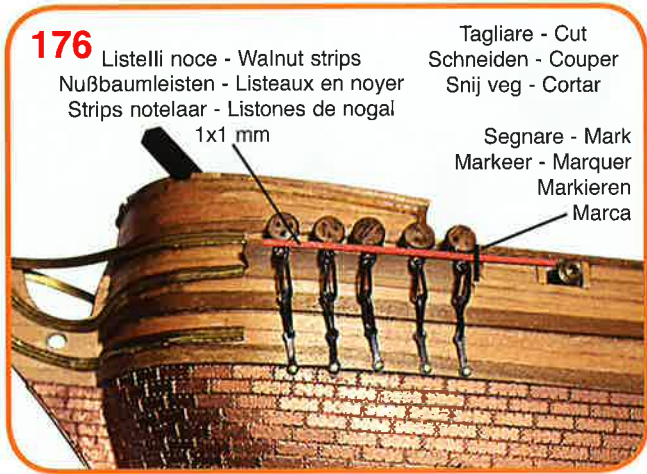

183

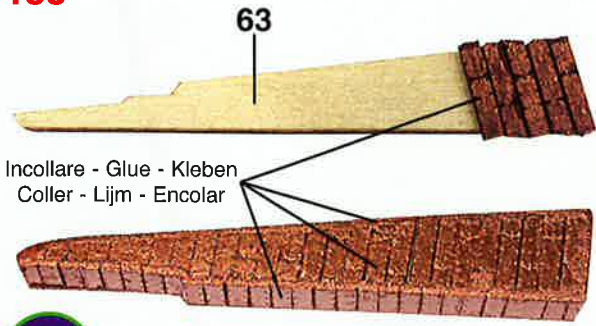

P.14

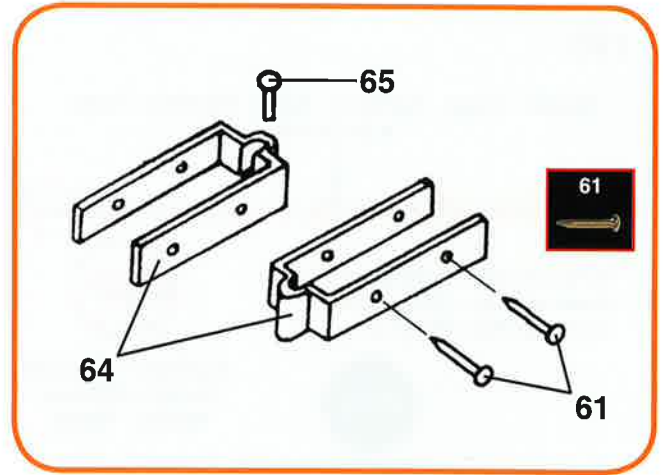

184

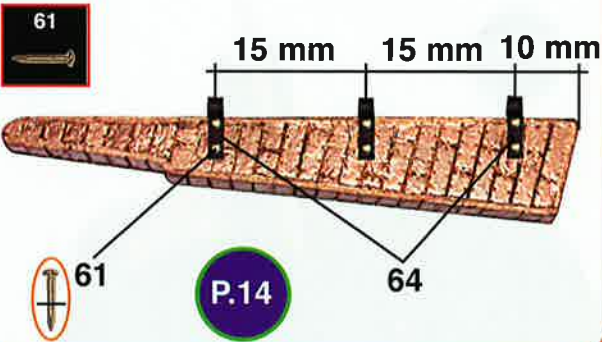

P.14

185

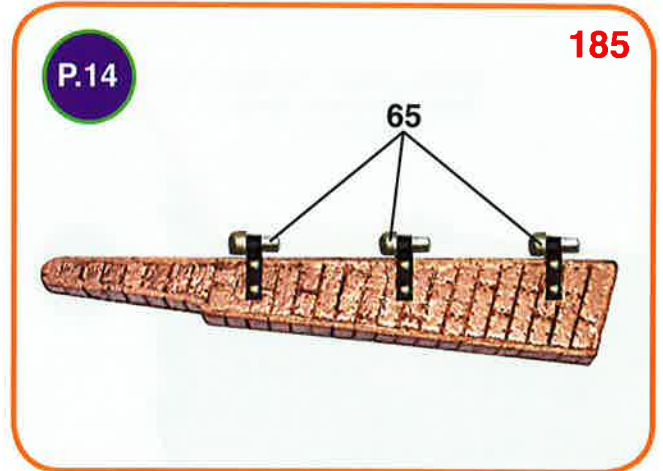

P.14

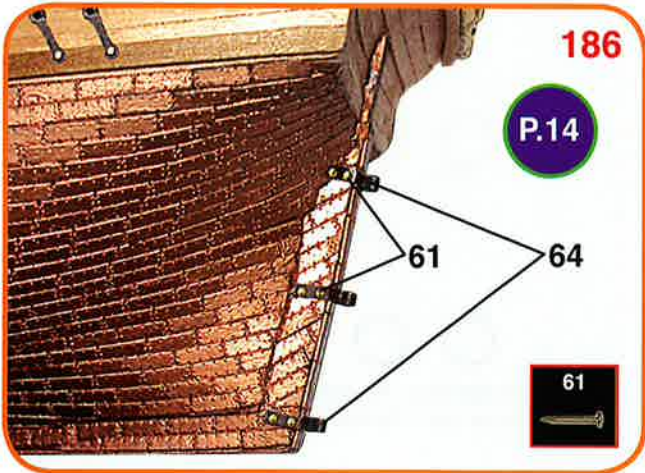

186

P.14

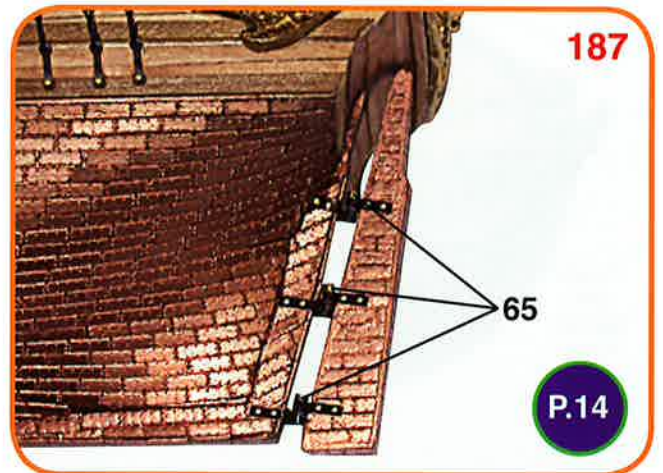

187

P.14

188

P.15



Tondino - Dowel - Rundholz - Rond - Rondhout - Varilla
ø 2x110 mm

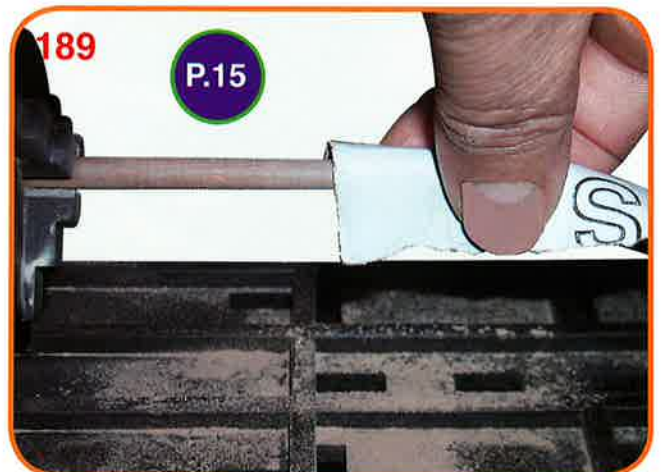

189

P.15

190

Tondino - Dowel - Rundholz - Rond - Rondhout - Varilla
ø 2x110 mm



Verniciare ocra - Paint ochre
Ocker lackieren - Vernir ocre
Vernissen oker - Pintar ocre

P.15

Sagomare - To mould
Formen - Moulurer
Modeln - Perfilar

191

Tondino
Dowel
Rundholz
Rond
Rondhout
Varilla
ø 2x110 mm



P.15

192

Tondino - Dowel - Rundholz
Rond - Rondhout - Varilla
ø 2x110 mm



P.15

193

Forare
Drill
Bohren
Forer
Bohr
Perforar
ø 3 mm.

10 mm | 15 mm

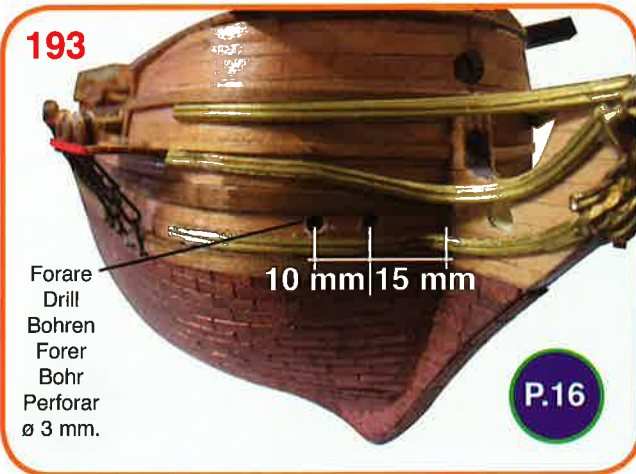

P.16

194

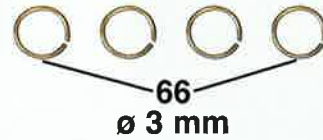

66
ø 3 mm

P.16



Verniciare nero - Paint black - Schwarz lackieren
Vernir noir - Vernissen zwart - Pintar negro

195

Incollare - Glue - Kleben
Coller - Lijm - Encolar



66

P.16



66

66

P.16

196

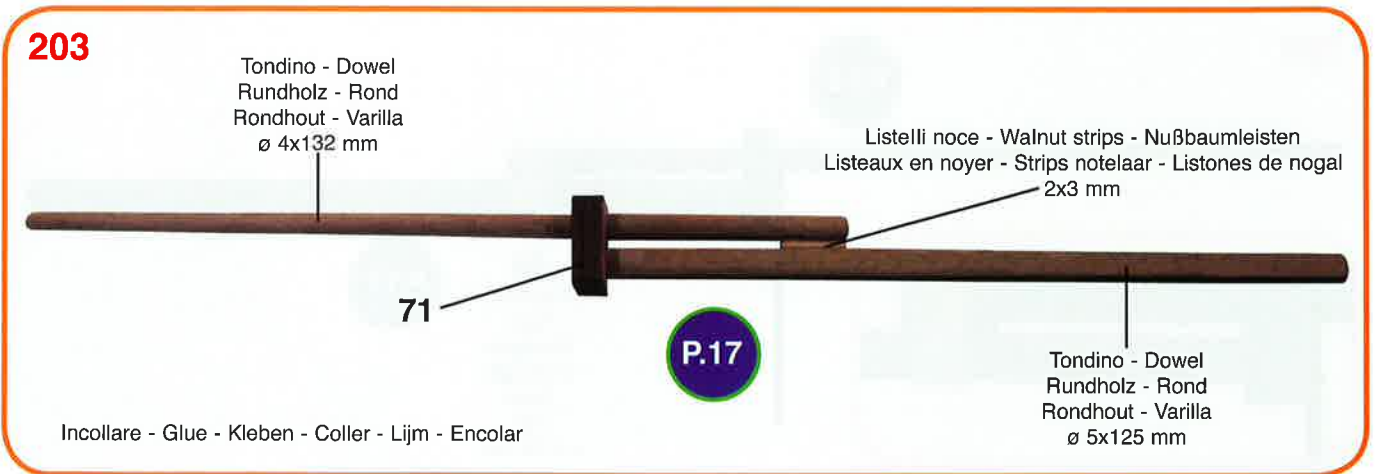
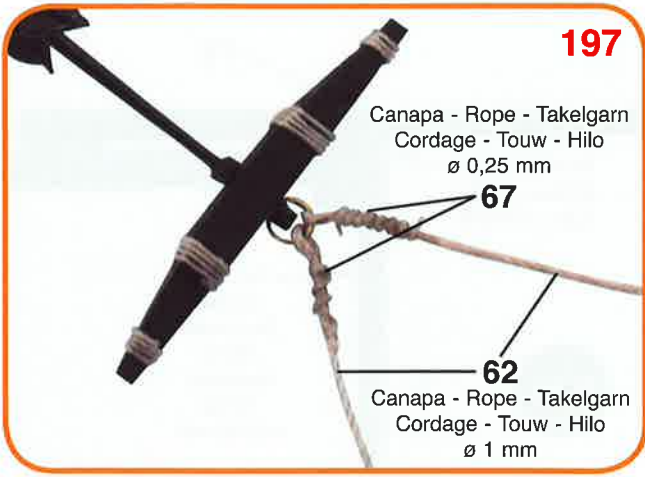

204

P.18

Tondino - Dowel - Rundholz - Rond - Rondhout - Varilla
ø 2x38 mm



Sagomare - To mould - Formen
Moulerer - Modeln - Perfilar

205

71

Incollare - Glue
Kleben - Coller
Lijm - Encolar

P.18

Tondino
Dowel
Rundholz
Rond
Rondhout
Varilla
ø 2x38 mm

206

71

Listelli noce - Walnut strips - Nußbaumleisten
Listeaux en noyer - Strips notelaar - Listones de nogal
2x3 mm

Tondino - Dowel
Rundholz - Rond
Rondhout - Varilla
ø 4x132 mm

P.18

Tondino
Dowel
Rundholz
Rond
Rondhout
Varilla
ø 2x38 mm

P.17

Tondino - Dowel
Rundholz - Rond
Rondhout - Varilla
ø 5x125 mm

207

Verniciare nero - Paint black
Schwarz lackieren - Vernir noir
Vernissen zwart - Pintar negro

P.17

P.18

208

P.18

P.17

40
Canapa
Rope
Takelgarn
Cordage
Touw
Hilo
ø 0,50 mm

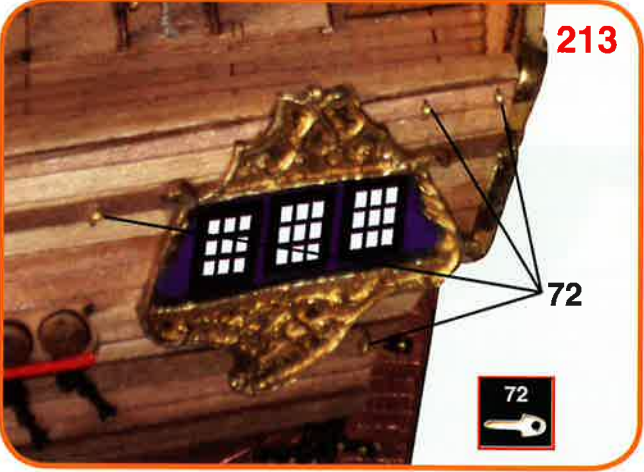
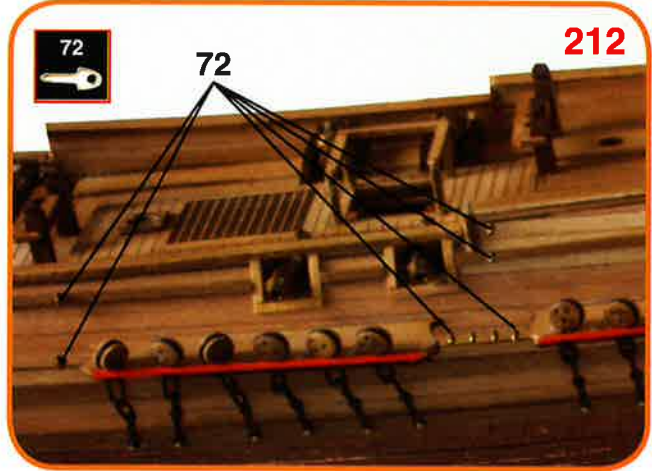
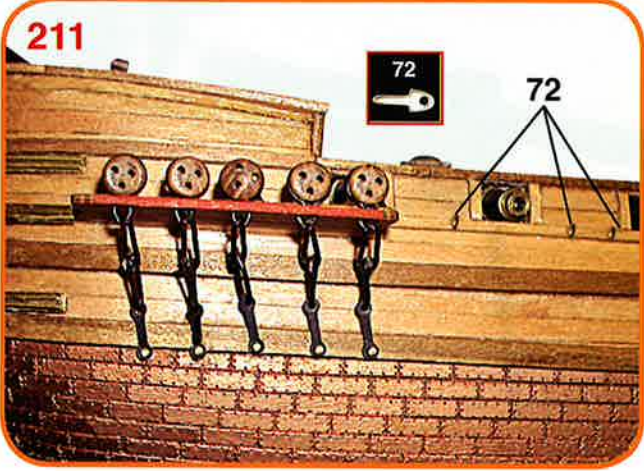
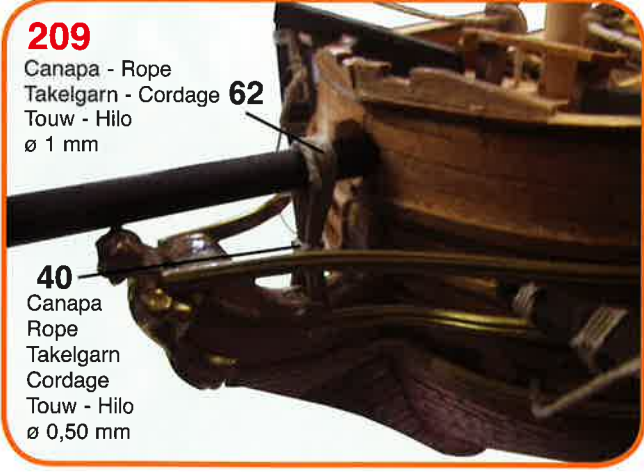

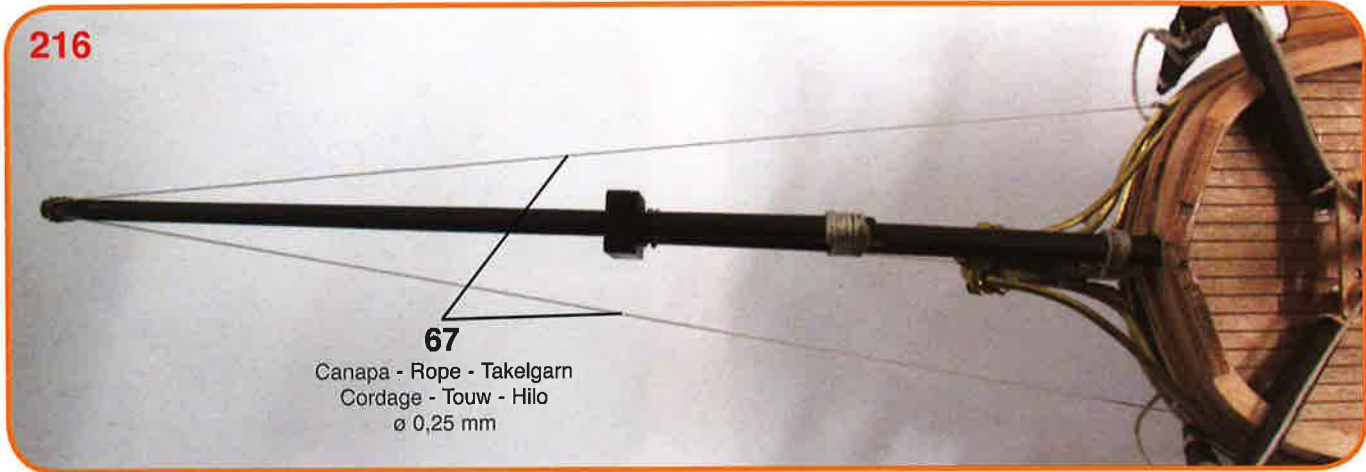

216

67

Canapa - Rope - Takelgarn
Cordage - Touw - Hilo
ø 0,25 mm

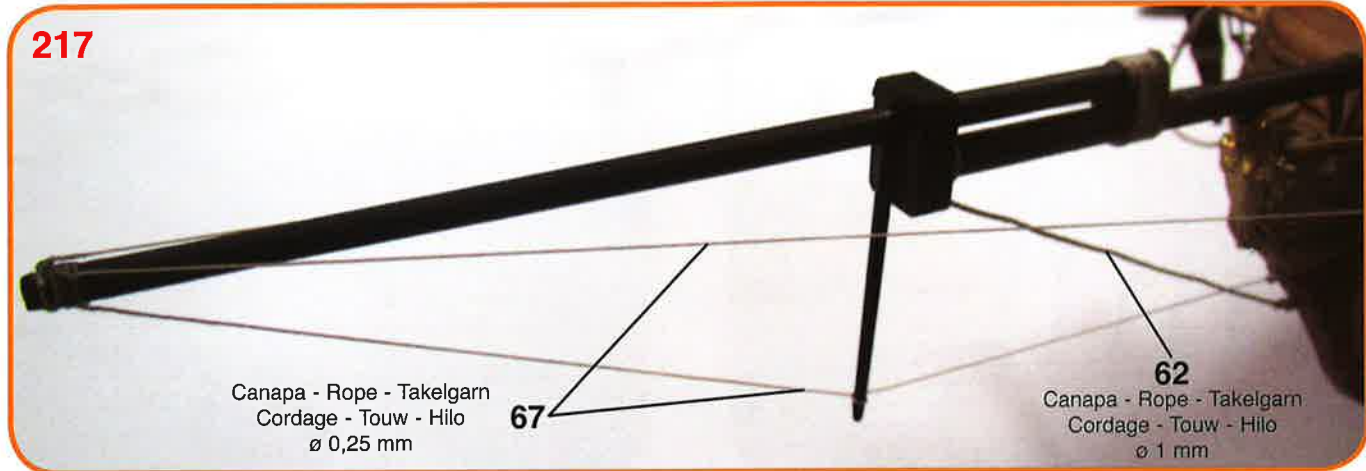

217

67

Canapa - Rope - Takelgarn
Cordage - Touw - Hilo
ø 0,25 mm

62

Canapa - Rope - Takelgarn
Cordage - Touw - Hilo
ø 1 mm

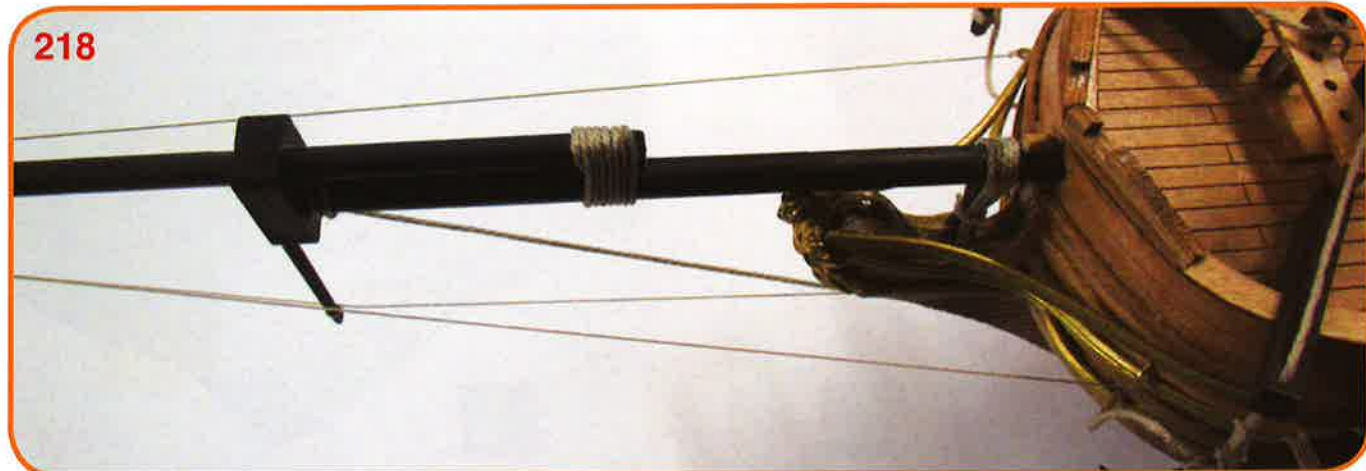

218

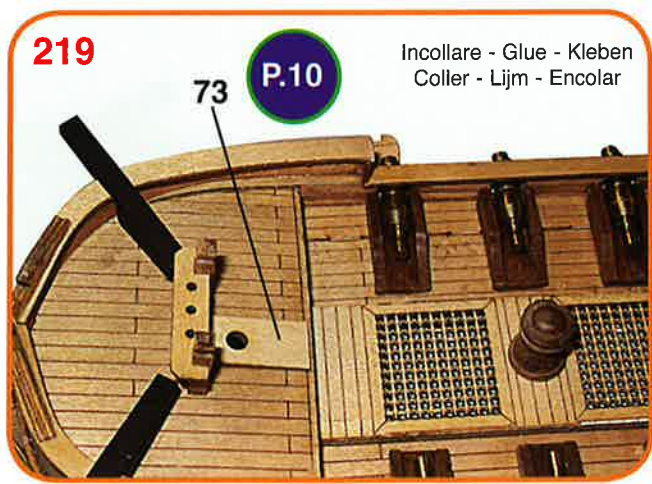

219

73

P.10

Incollare - Glue - Kleben
Coller - Lijm - Encolar

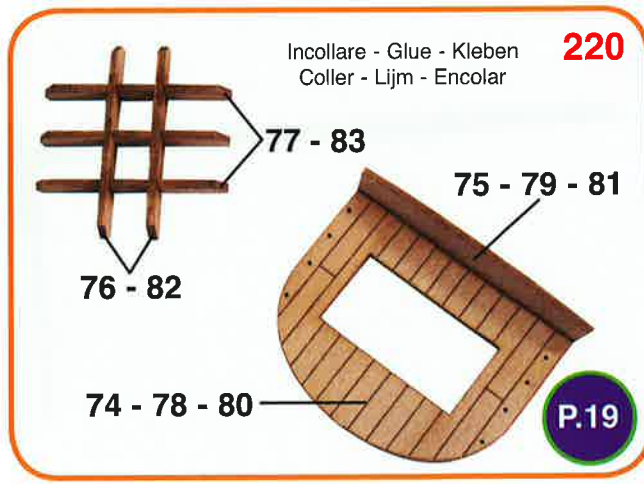

220

Incollare - Glue - Kleben
Coller - Lijm - Encolar

76 - 82

77 - 83

75 - 79 - 81

74 - 78 - 80

P.19

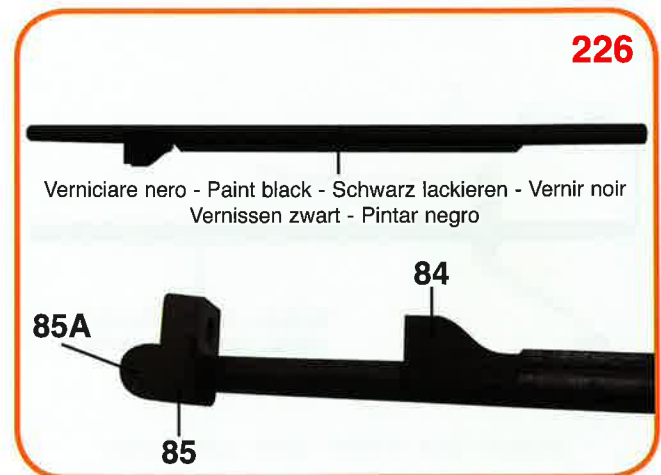
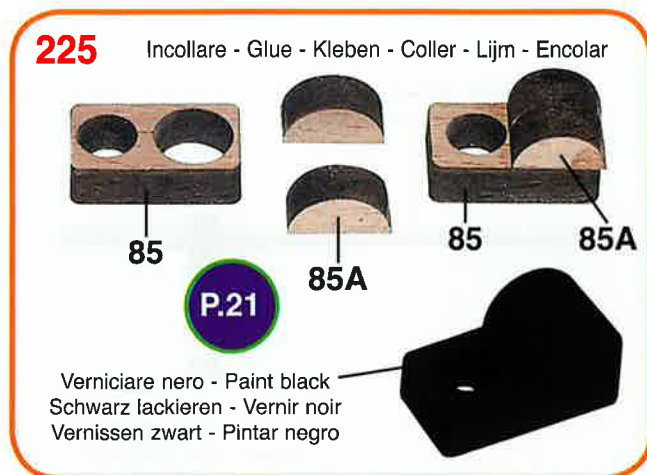
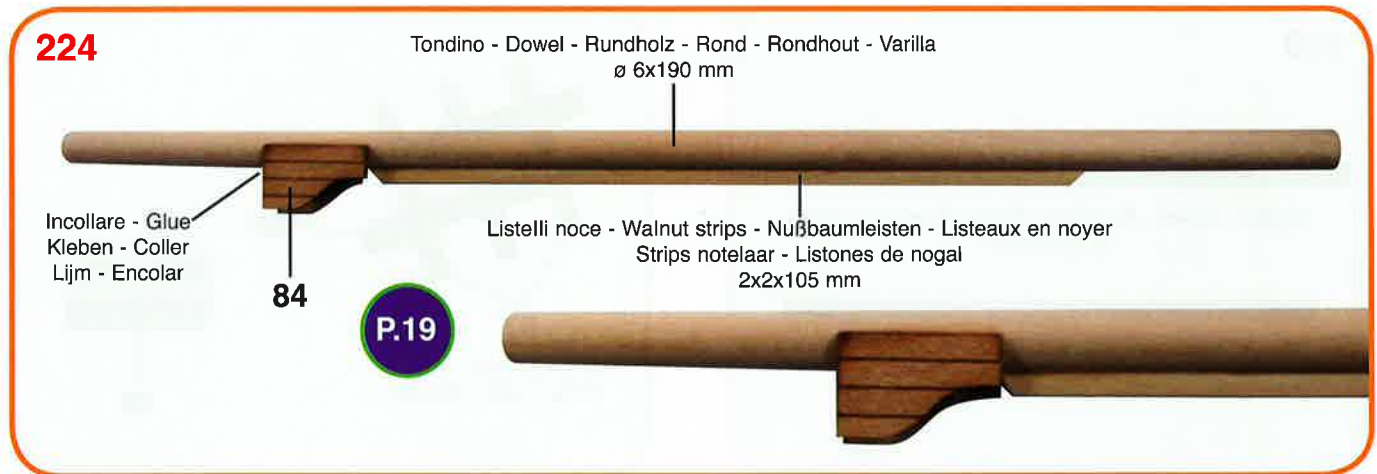
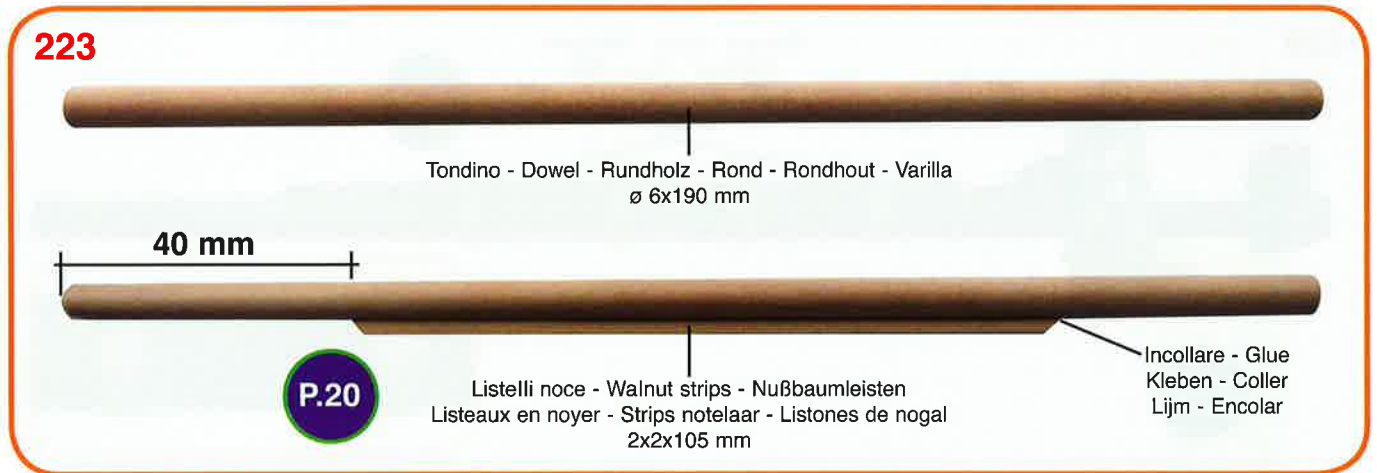
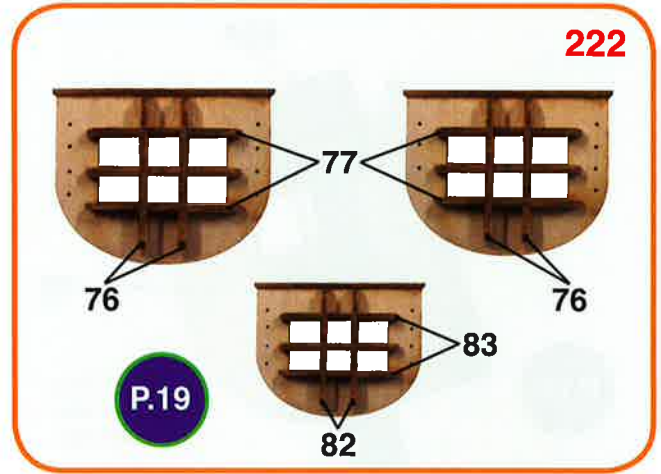
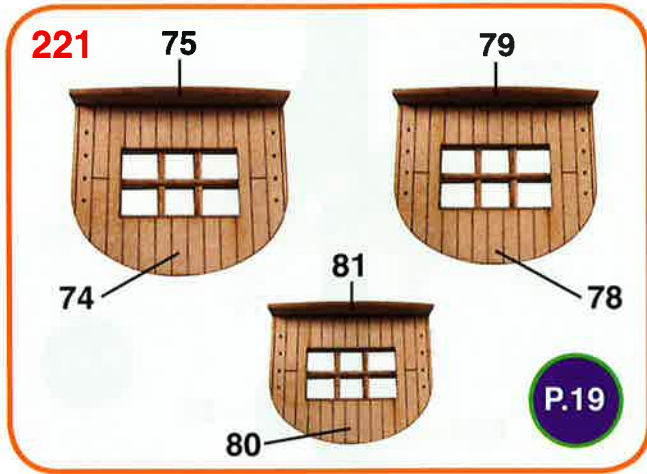

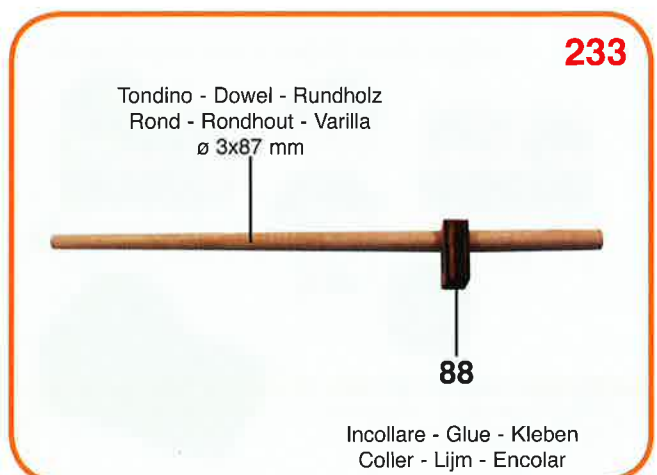
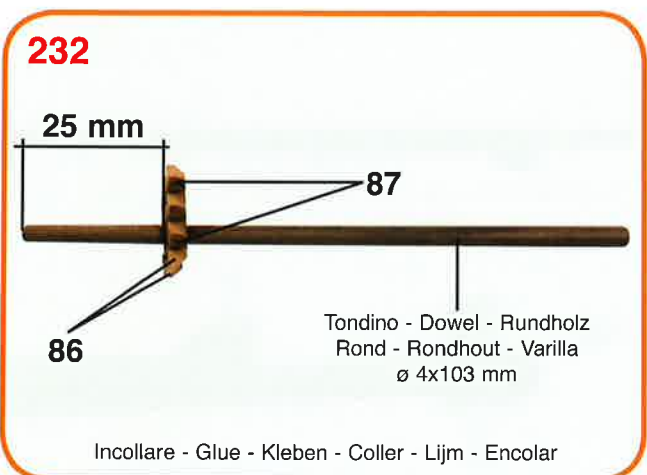
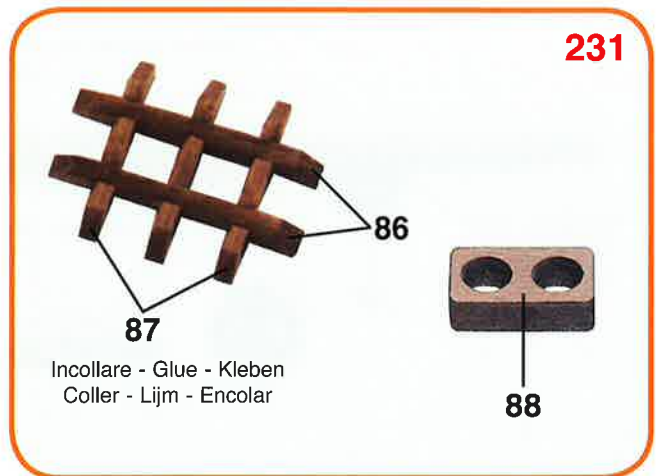
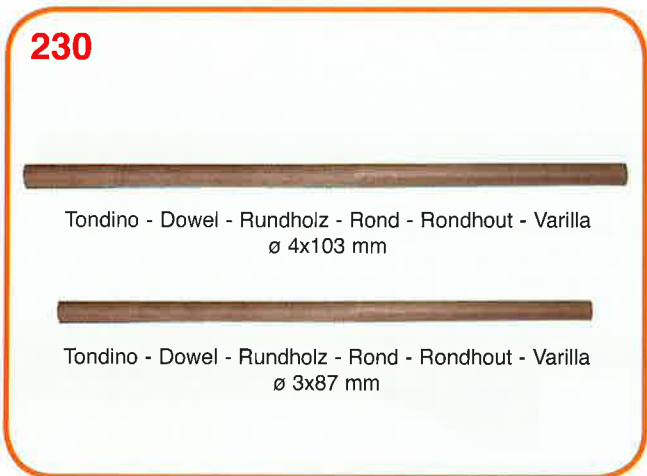
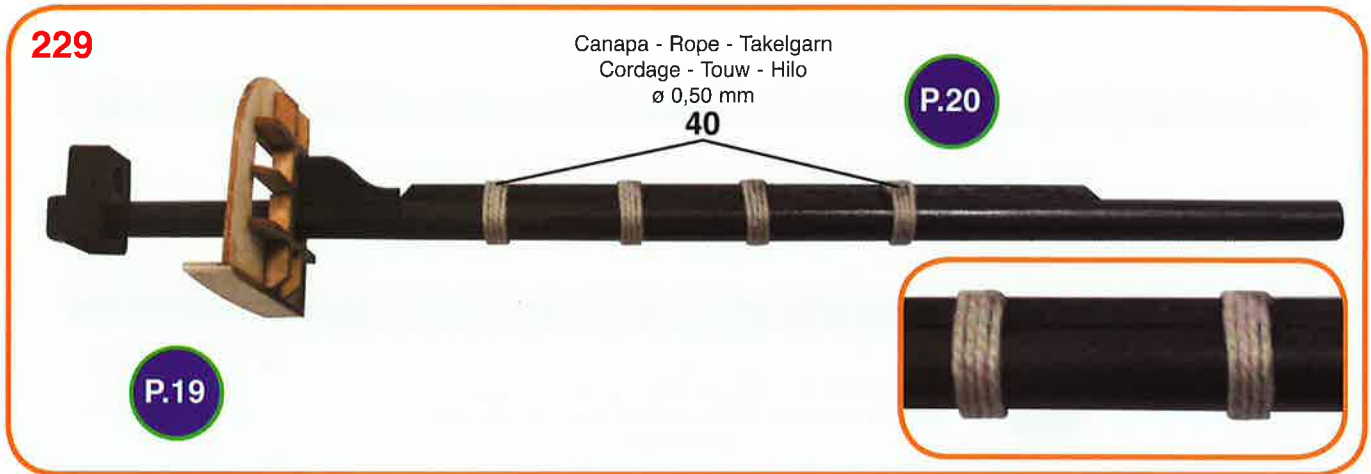
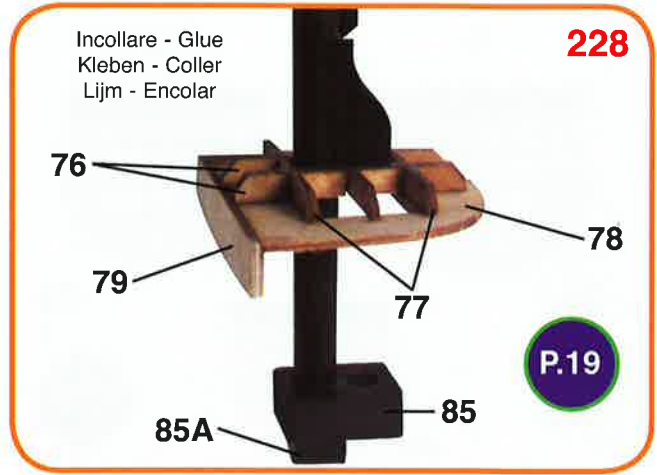
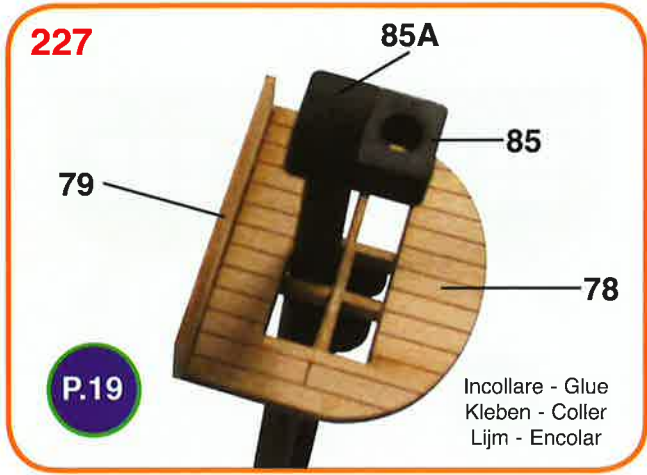

234

Incollare - Glue - Kleben - Coller - Lijm - Encolar

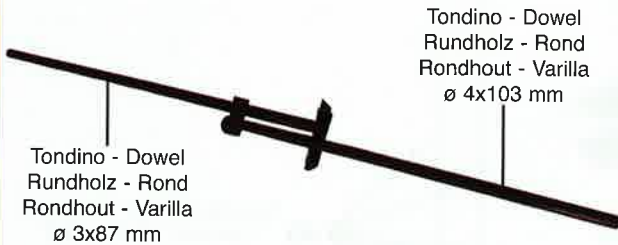

Verniciare nero - Paint black - Schwarz lackieren - Vernir noir
Vernissen zwart - Pintar negro

235

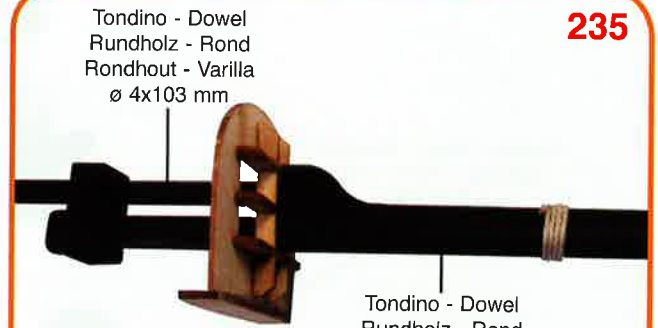

Incollare - Glue - Kleben - Coller - Lijm - Encolar

236

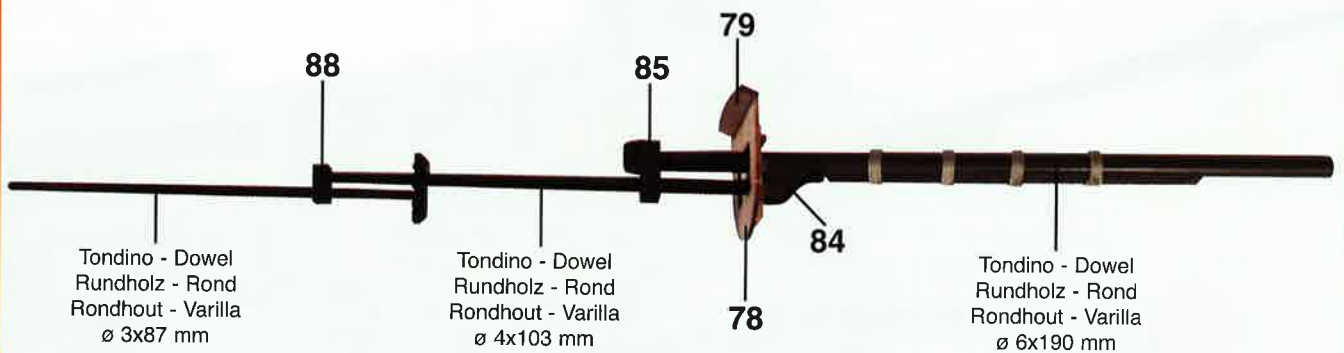

237



238

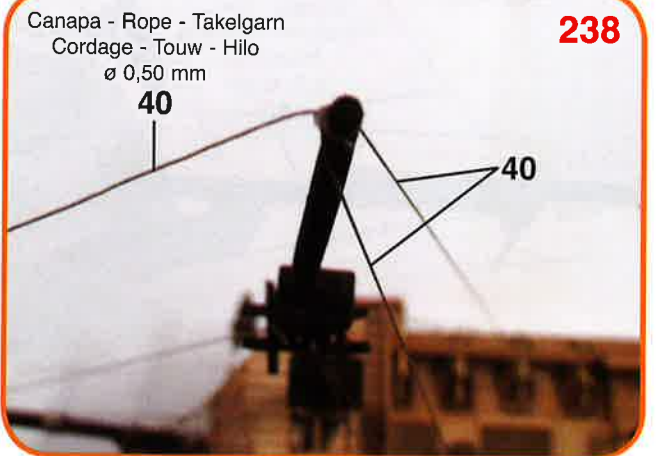

239



240

Canapa - Rope - Takelgarn
Cordage - Touw - Hilo
ø 0,50 mm

40

P.22

Canapa - Rope
Takelgarn - Cordage
Touw - Hilo
ø 0,50 mm

40

Canapa - Rope - Takelgarn
Cordage - Touw - Hilo
ø 0,50 mm

40

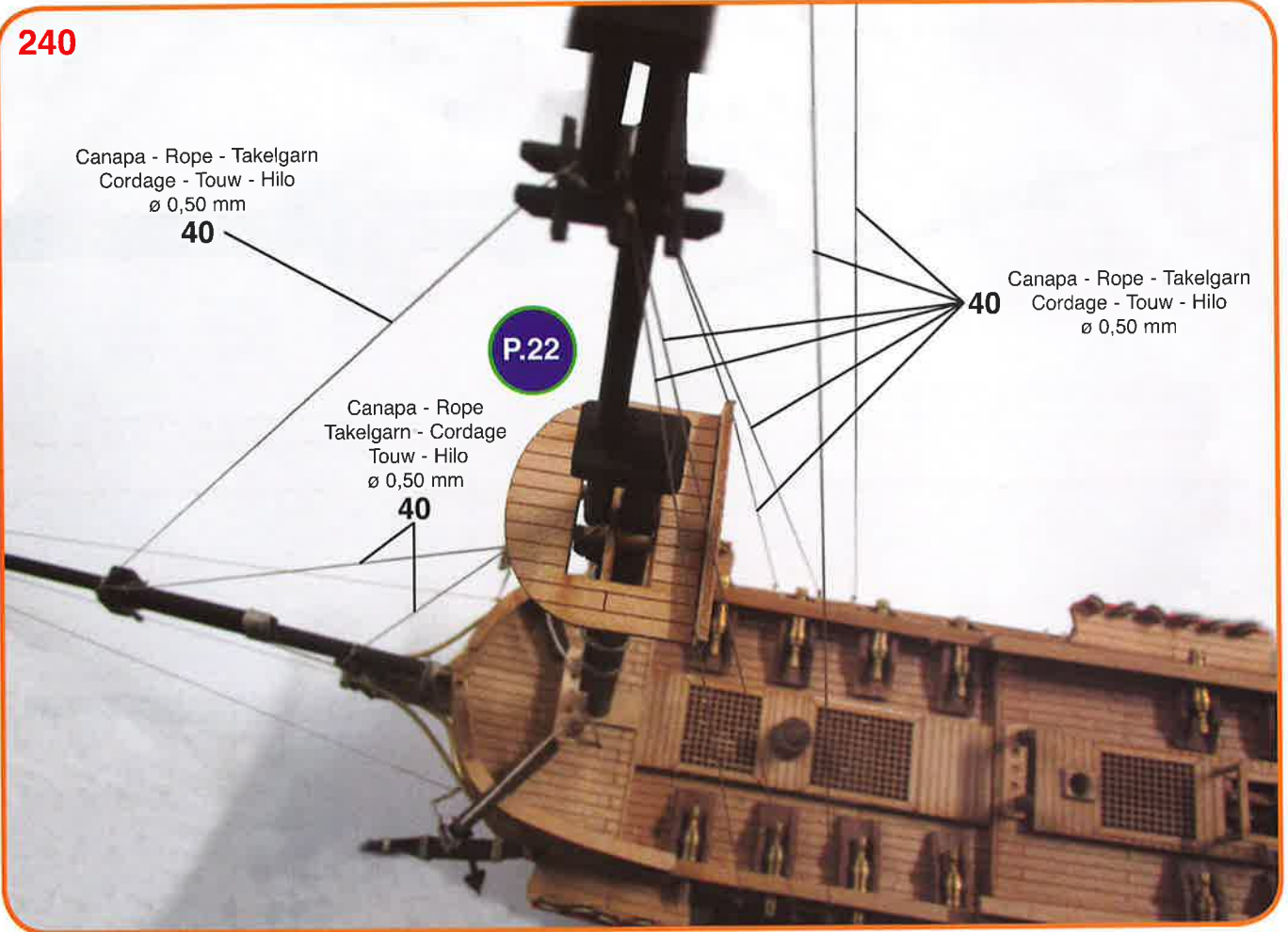

241

Canapa - Rope
Takelgarn - Cordage
Touw - Hilo
ø 0,50 mm

40

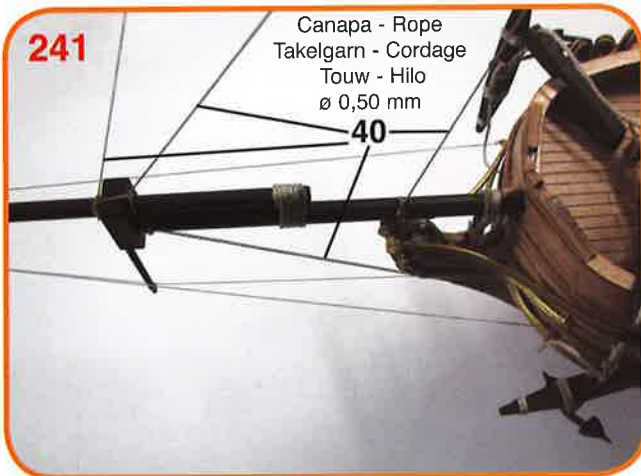

242

40

Canapa - Rope - Takelgarn
Cordage - Touw - Hilo
ø 0,50 mm

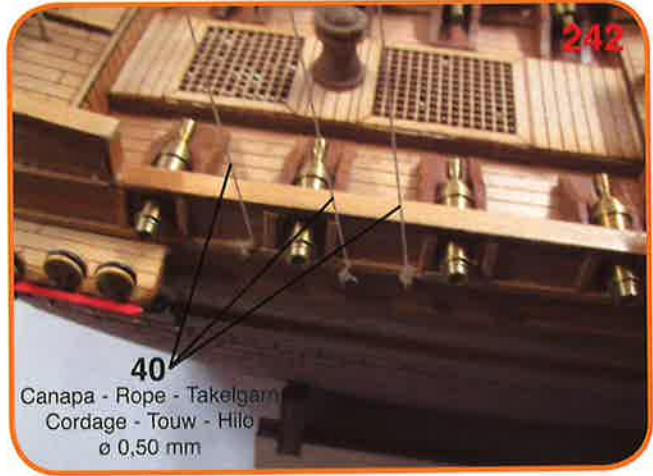

243

40

58

P.23

67

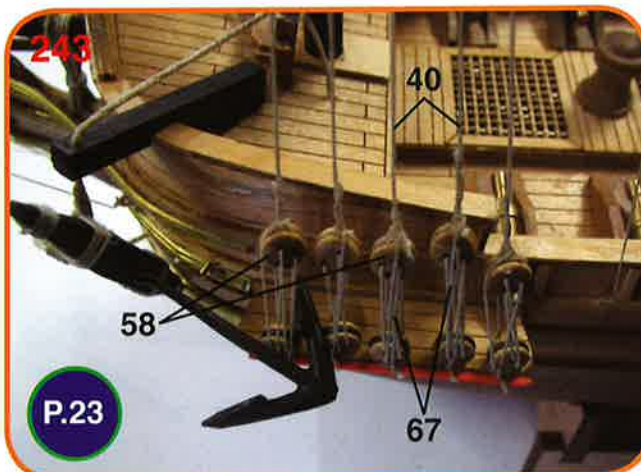

244

P.24

67



245

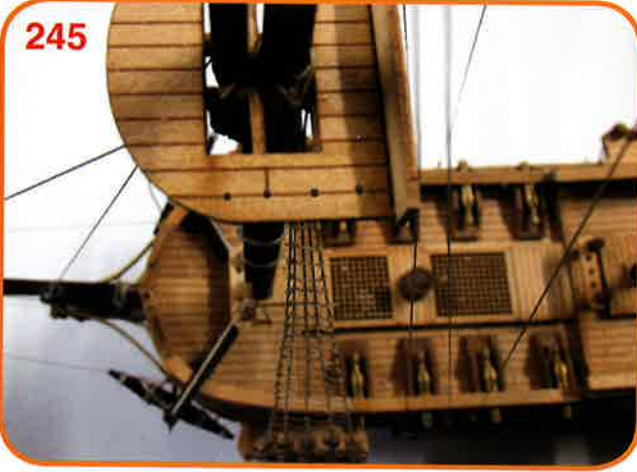

246

Tondino - Dowel - Rundholz - Rond - Rondhout - Varilla
 ø 6x195 mm

Tondino - Dowel - Rundholz - Rond - Rondhout - Varilla
 ø 4x122 mm

Tondino - Dowel - Rundholz - Rond - Rondhout - Varilla
 ø 3x108 mm

247

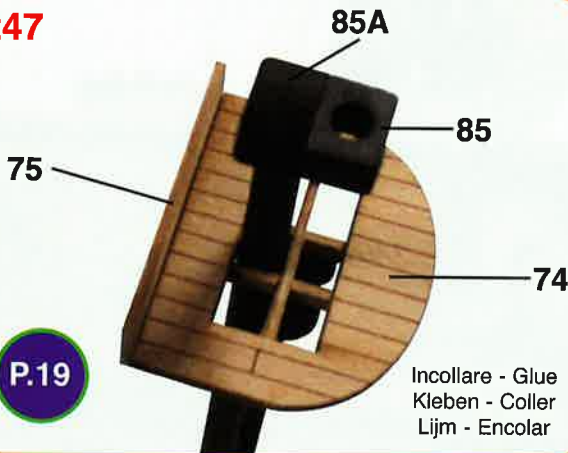

P.19

Incollare - Glue
 Kleben - Coller
 Lijm - Encolar

248

Incollare - Glue
 Kleben - Coller
 Lijm - Encolar

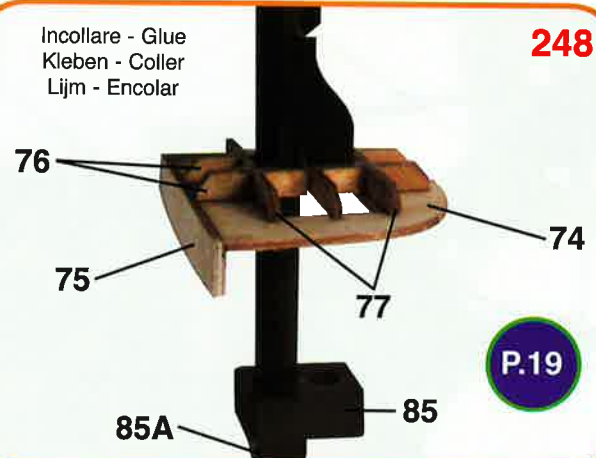

P.19

249

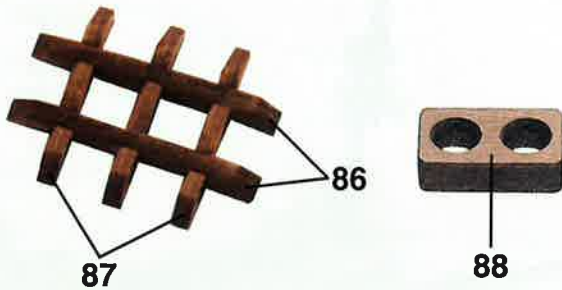

Incollare - Glue - Kleben
 Coller - Lijm - Encolar

250

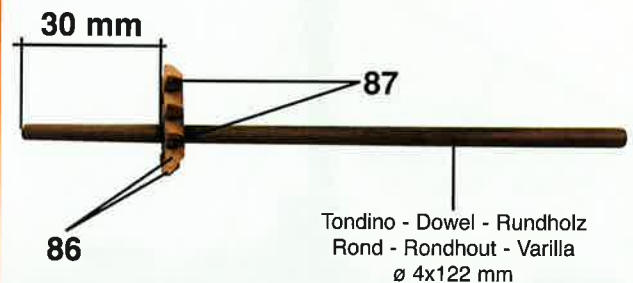

Tondino - Dowel - Rundholz
 Rond - Rondhout - Varilla
 ø 4x122 mm

Incollare - Glue - Kleben - Coller - Lijm - Encolar

251

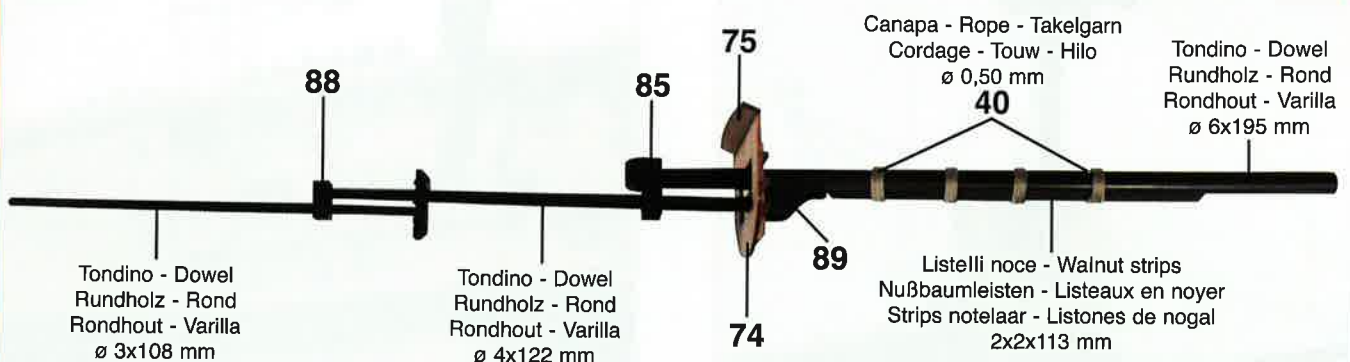

Tondino - Dowel
 Rundholz - Rond
 Rondhout - Varilla
 ø 3x108 mm

Tondino - Dowel
 Rundholz - Rond
 Rondhout - Varilla
 ø 4x122 mm

Canapa - Rope - Takelgarn
 Cordage - Touw - Hilo
 ø 0,50 mm

Tondino - Dowel
 Rundholz - Rond
 Rondhout - Varilla
 ø 6x195 mm

Listelli noce - Walnut strips
 Nußbaumleisten - Listeaux en noyer
 Strips notelaar - Listones de nogal
 2x2x113 mm

252

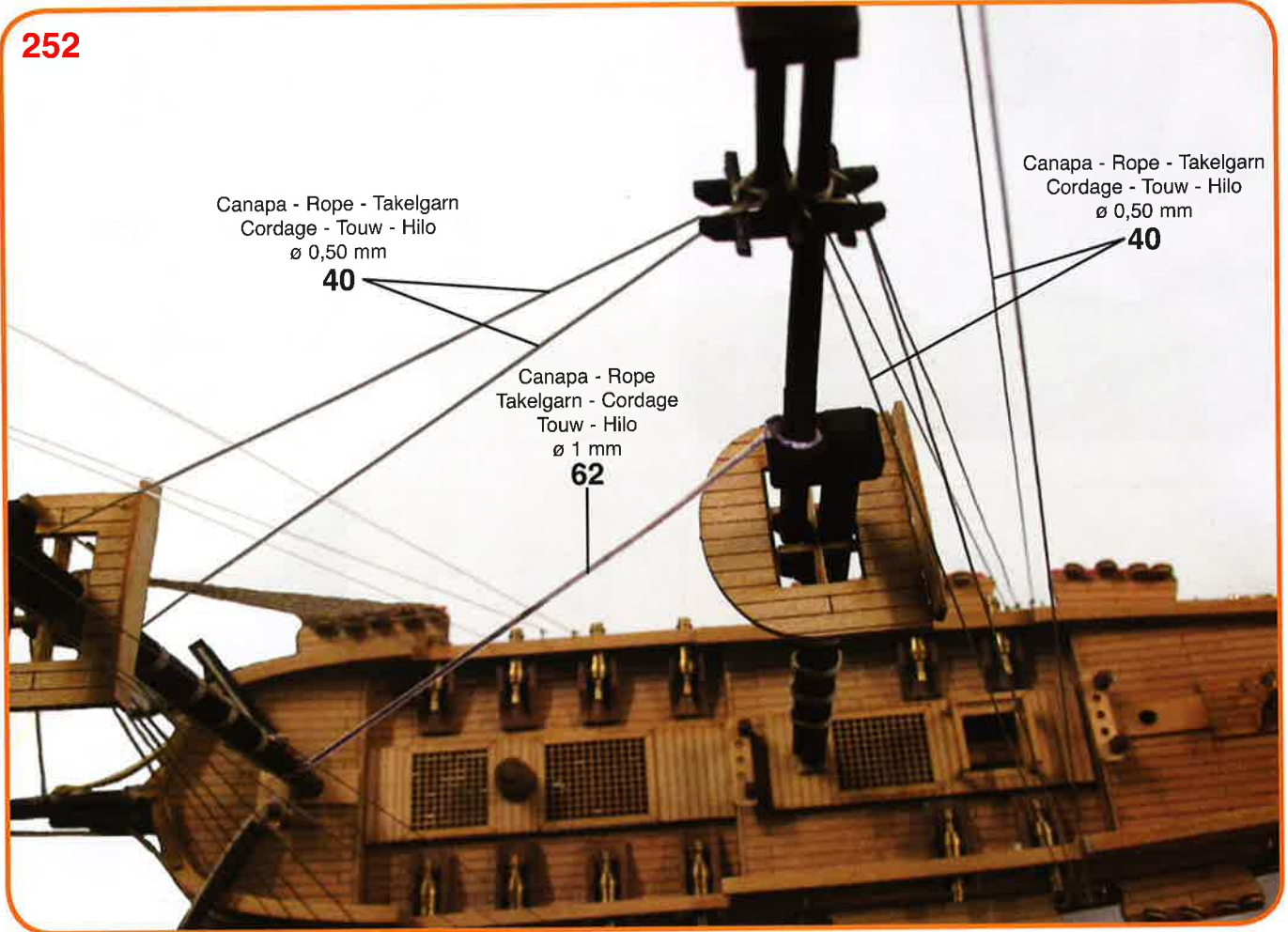

Canapa - Rope - Takelgarn
Cordage - Touw - Hilo
ø 0,50 mm
40

Canapa - Rope - Takelgarn
Cordage - Touw - Hilo
ø 0,50 mm
40

Canapa - Rope
Takelgarn - Cordage
Touw - Hilo
ø 1 mm
62

253

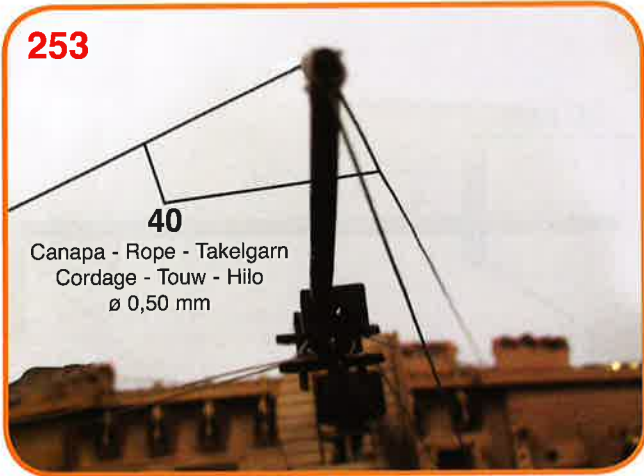

40
Canapa - Rope - Takelgarn
Cordage - Touw - Hilo
ø 0,50 mm

254

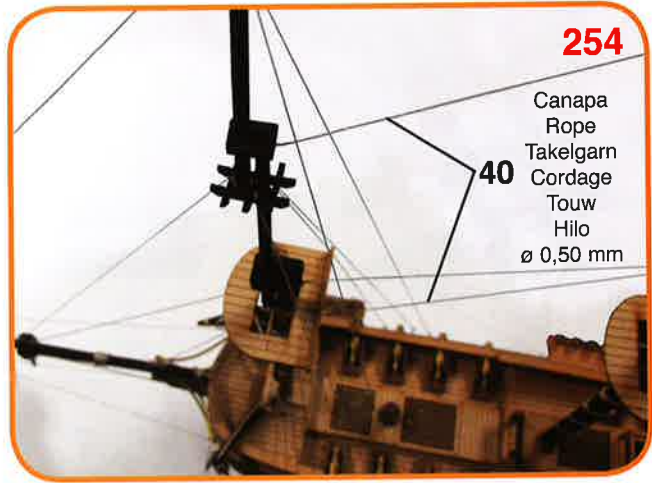

Canapa
Rope
Takelgarn
Cordage
Touw
Hilo
ø 0,50 mm
40

255



40

256

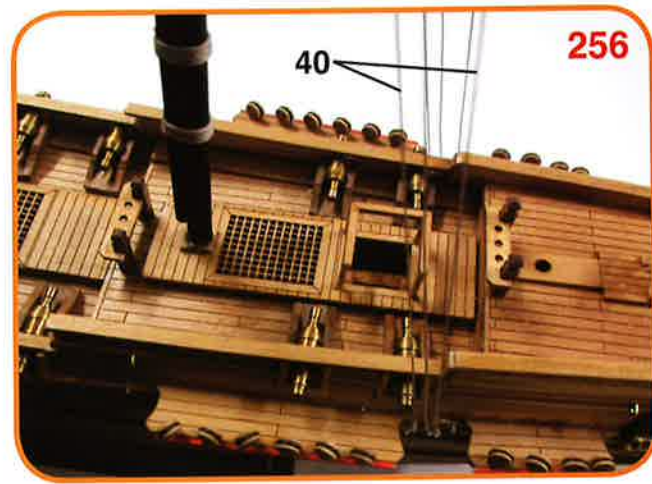

40

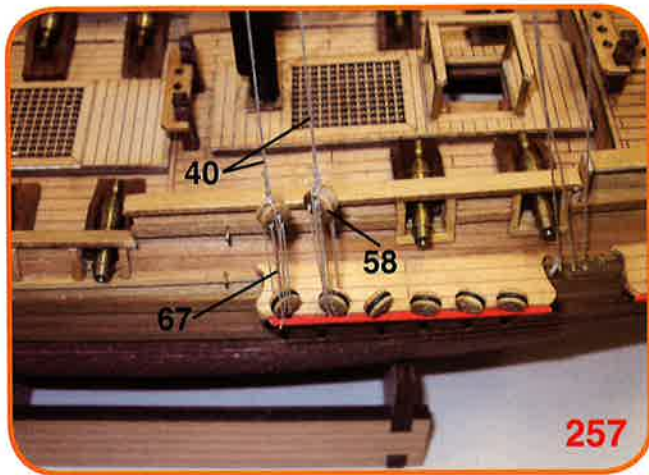

257

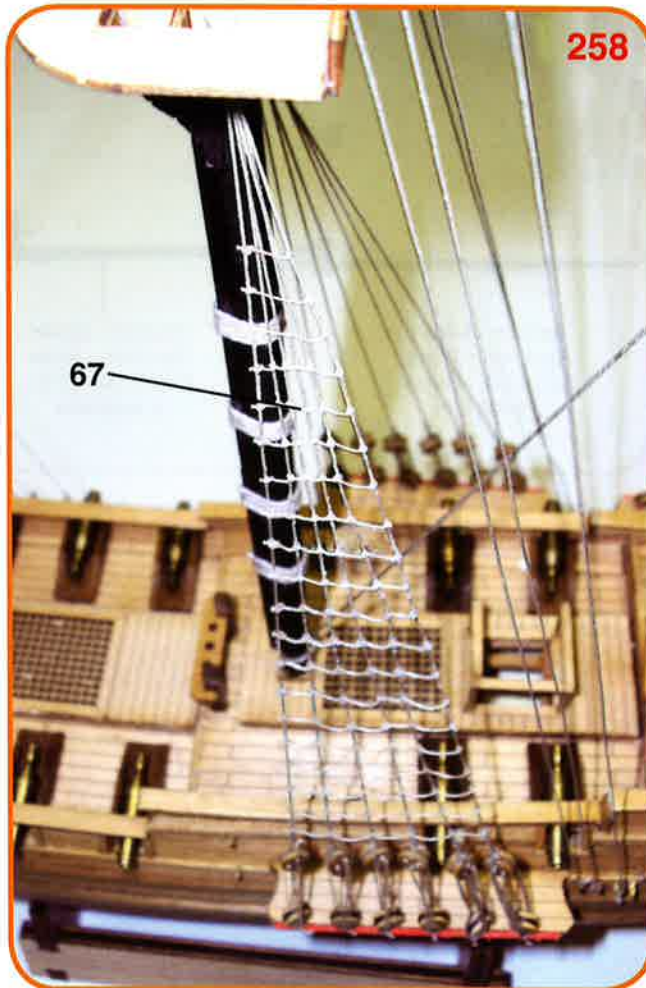

258

259

Tondino - Dowel - Rundholz - Rond - Rondhout - Varilla
 ø 5x190 mm

Tondino - Dowel - Rundholz - Rond - Rondhout - Varilla
 ø 4x94 mm

Tondino - Dowel - Rundholz - Rond - Rondhout - Varilla
 ø 3x80 mm

260

90A

90

81

80

P.19

Incollare - Glue Kleben - Coller Lijm - Encolar

Incollare - Glue Kleben - Coller Lijm - Encolar

82

81

83

80

90A

90

P.19

262

86

87

88

Incollare - Glue - Kleben Coller - Lijm - Encolar

263

25 mm

87

86

Tondino - Dowel - Rundholz Rond - Rondhout - Varilla
 ø 4x94 mm

Incollare - Glue - Kleben - Coller - Lijm - Encolar

264

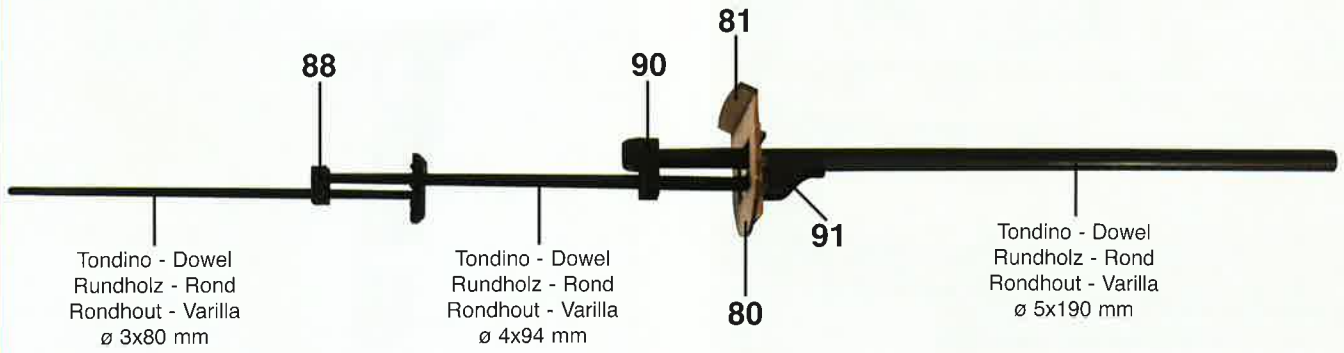

265

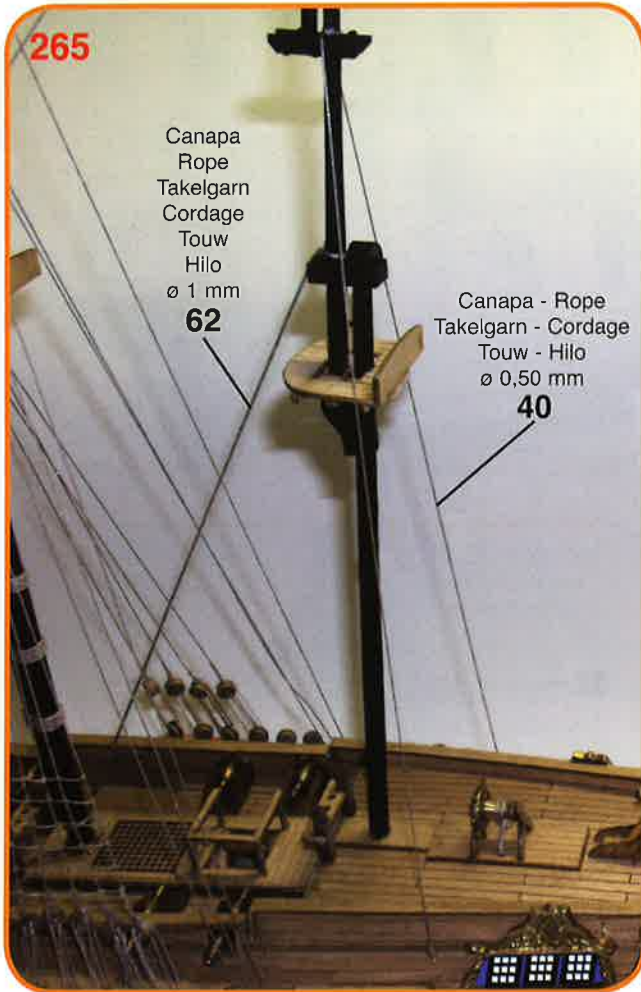

266

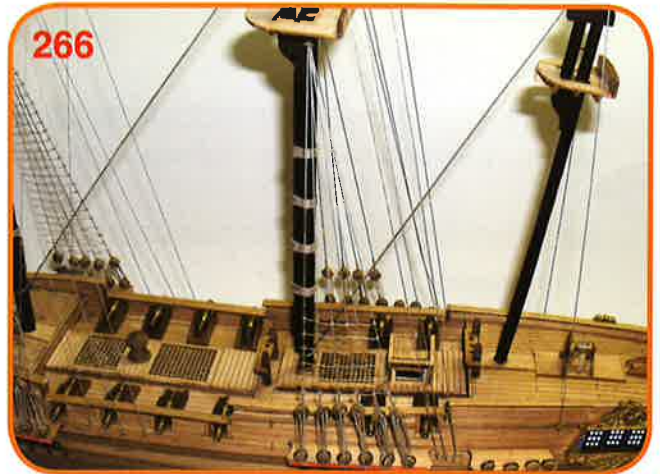

267

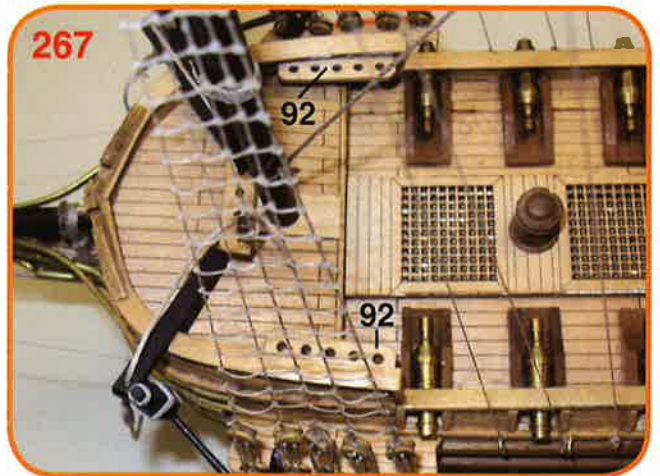

268

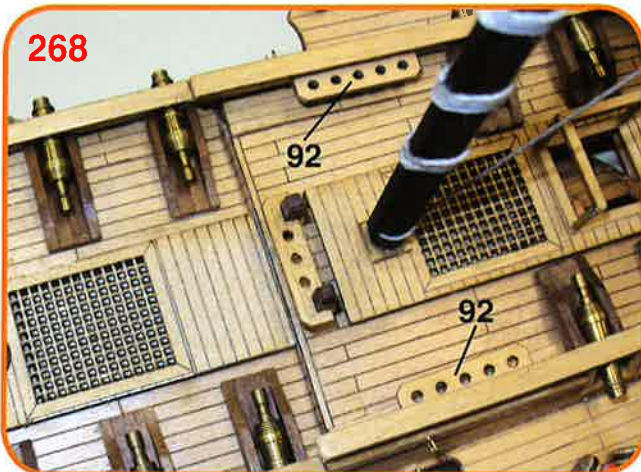

269

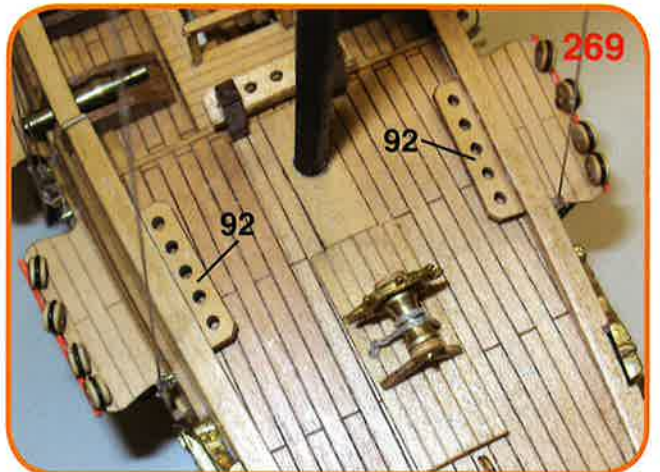

270



Tondino - Dowel - Rundholz - Rond - Rondhout - Varilla
ø 4x138 mm



Tondino - Dowel - Rundholz - Rond - Rondhout - Varilla
ø 3x70 mm

P.25

P.25



Sagomare - To mould
Formen - Moulurer
Modeln - Perfilar

271

93



Incollare - Glue - Kleben
Coller - Lijm - Encolar

272

Tondino - Dowel - Rundholz
Rond - Rondhout - Varilla
ø 4x138 mm



Tondino - Dowel - Rundholz
Rond - Rondhout - Varilla
ø 3x70 mm

P.25

P.25

273



Verniciare ocre - Paint ochre - Ockergelb lackieren - Vernir ocre
Vernissen oker - Pintar ocre

274

P.25

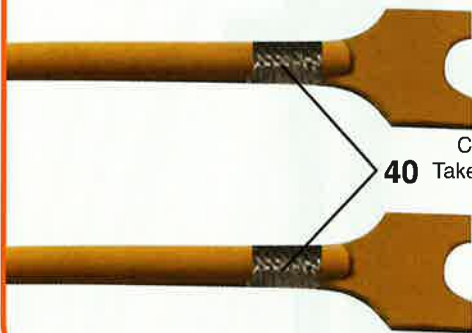

Canapa - Rope
40 Takelgarn - Cordage
Touw - Hilo
ø 0,50 mm



Tondino - Dowel
Rundholz - Rond
Rondhout - Varilla
ø 4x138 mm

275

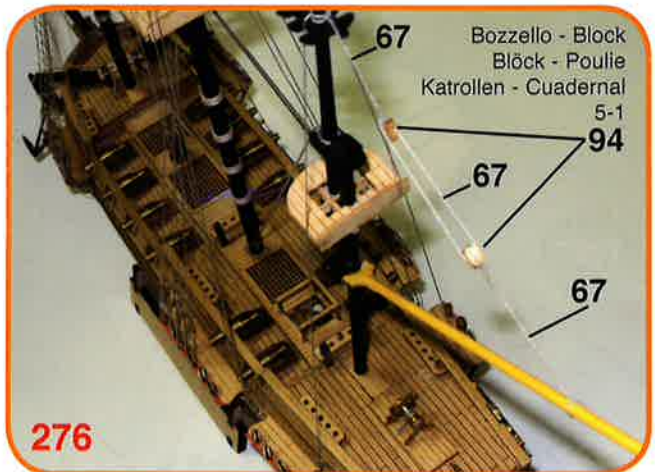
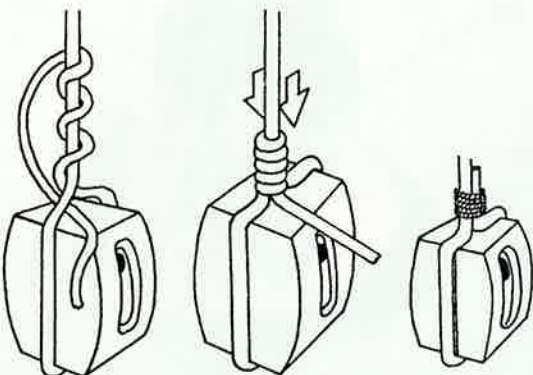

67 Bozzello - Block
Blöck - Poulie
Katrollen - Cuadernal

5-1
94

276

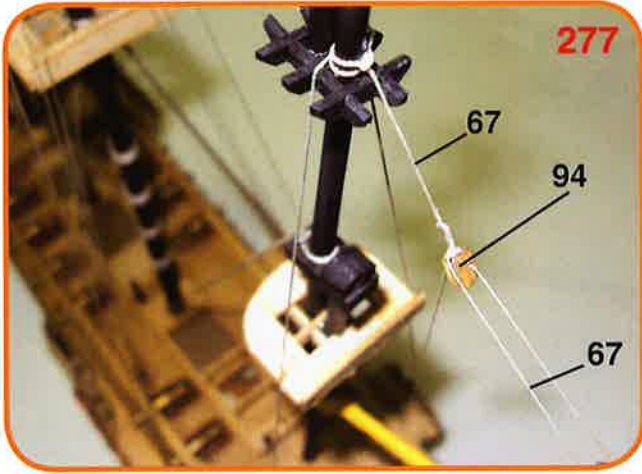

277

67

94

67

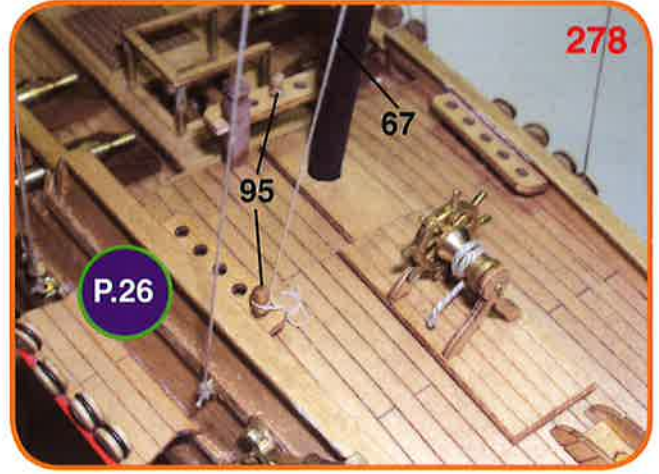

278

67

95

P.26

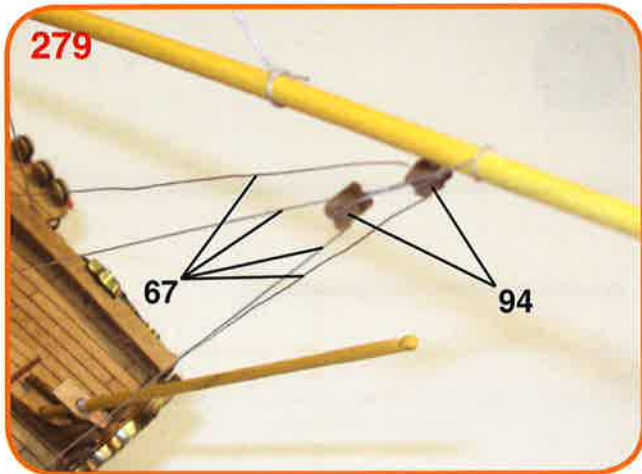

279

67

94

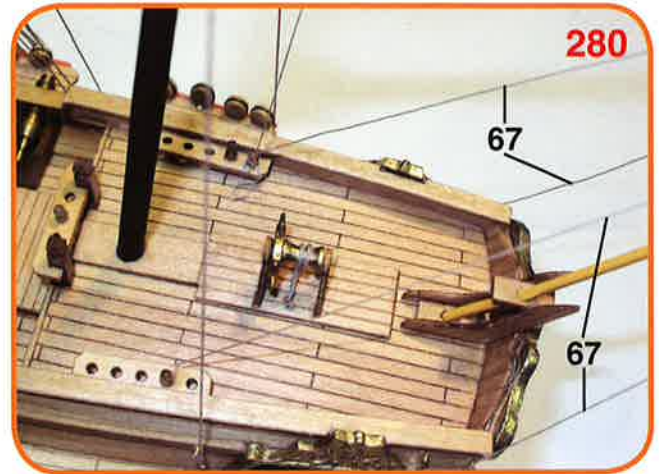

280

67

67



281

Canapa - Rope - Takelgarn
Cordage - Touw - Hilo
ø 0,50 mm

40

96
ø 3 mm

P.27

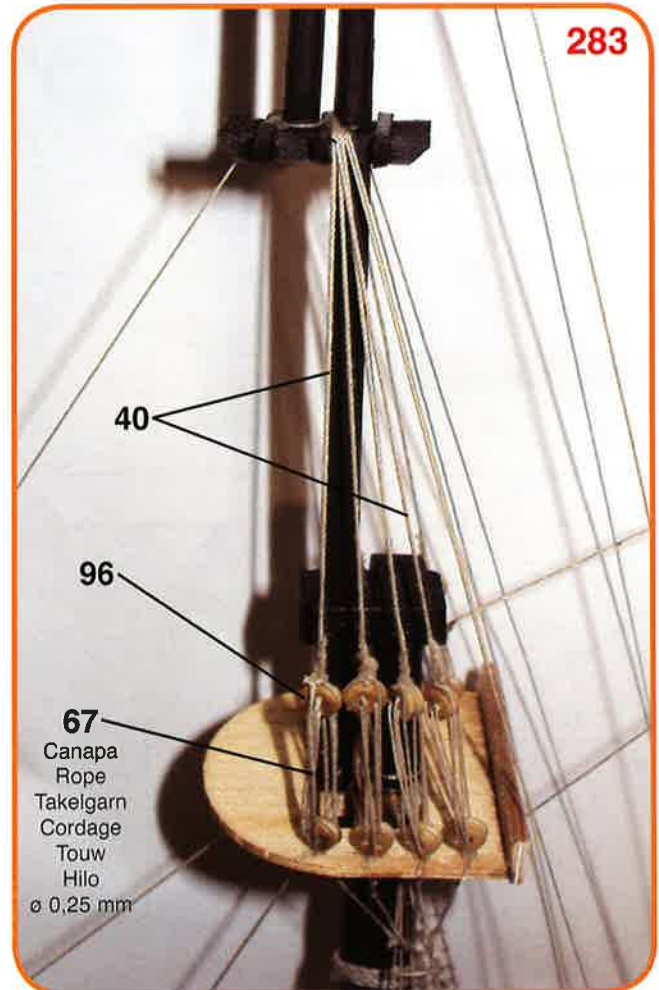

283

40

96

67

Canapa
Rope
Takelgarn
Cordage
Touw
Hilo
ø 0,25 mm

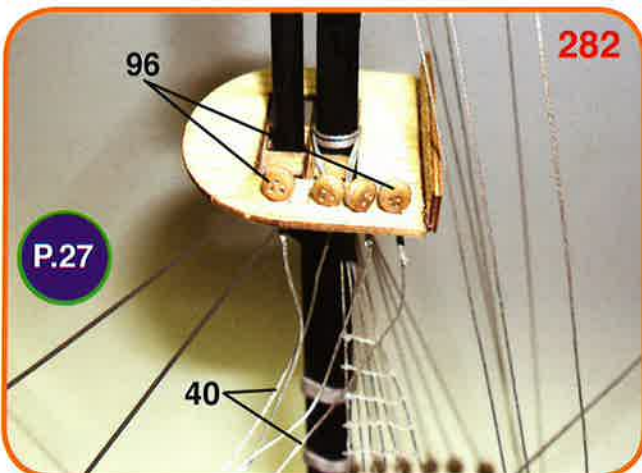

282

96

P.27

40

284

67
Canapa
Rope
Takelgarn
Cordage
Touw
Hilo
ø 0,25 mm



285

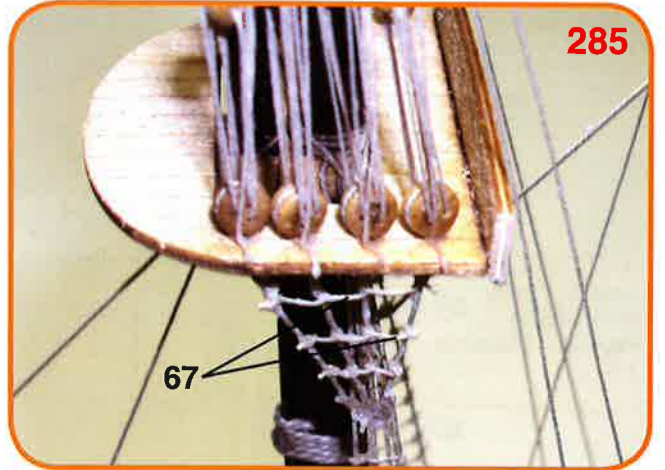

286



287



288

Tondino - Dowel - Rundholz - Rond - Rondhout - Varilla
ø 2x61 mm

Tondino - Dowel - Rundholz - Rond - Rondhout - Varilla
ø 2x75 mm

Tondino - Dowel - Rundholz - Rond - Rondhout - Varilla
ø 2x52 mm

Tondino - Dowel - Rundholz - Rond - Rondhout - Varilla
ø 3x80 mm

289

Verniciare ocre - Paint ochre - Ockergelb lackieren - Vernir ocre
Vernissen oker - Pintar ocre

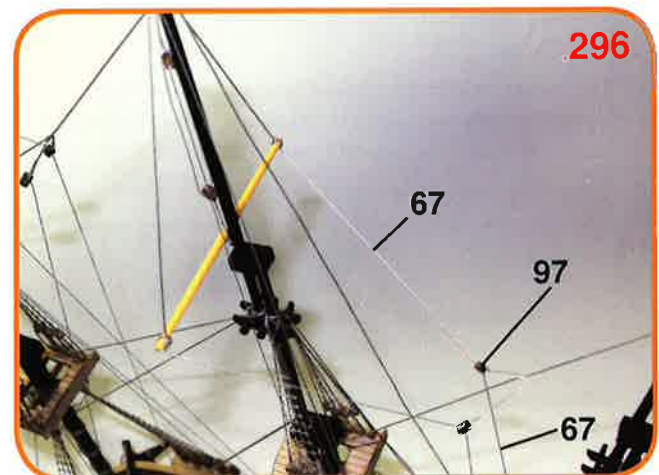
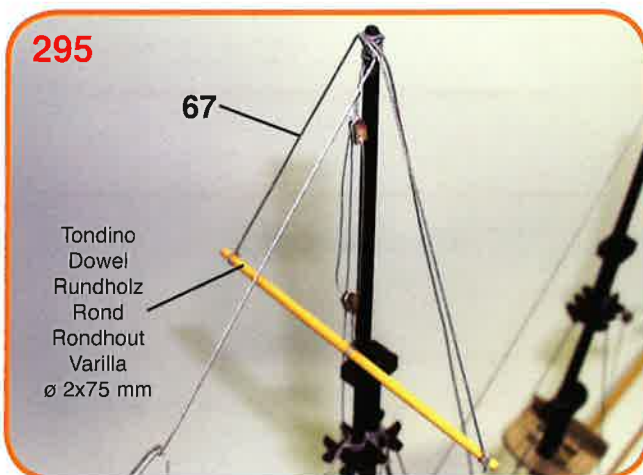
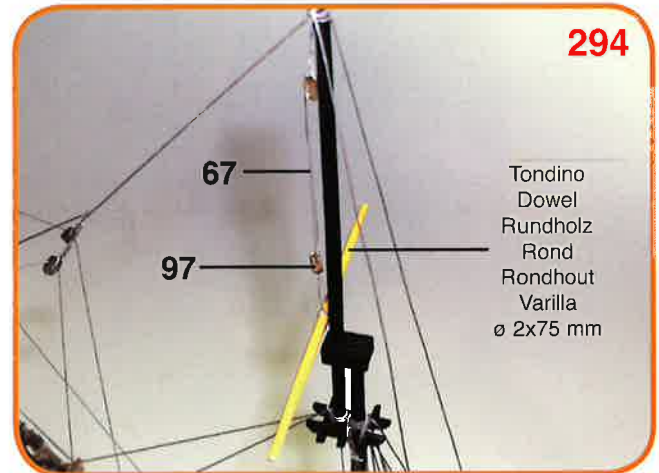
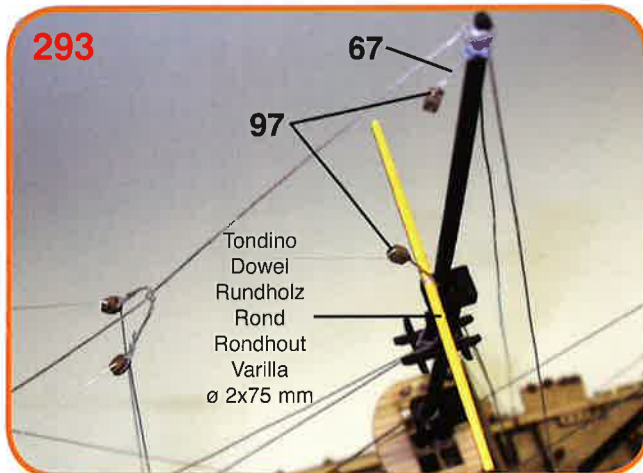
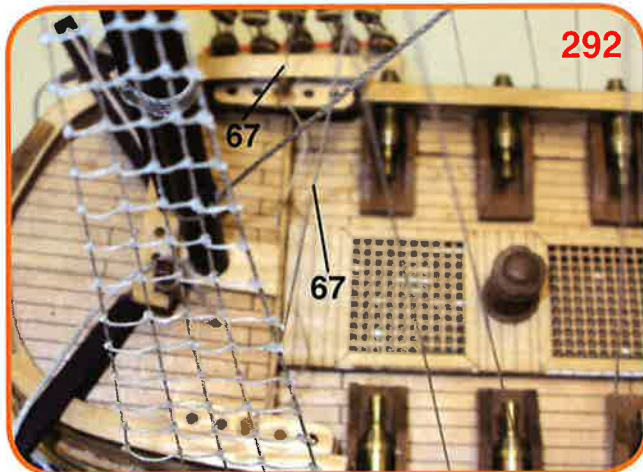
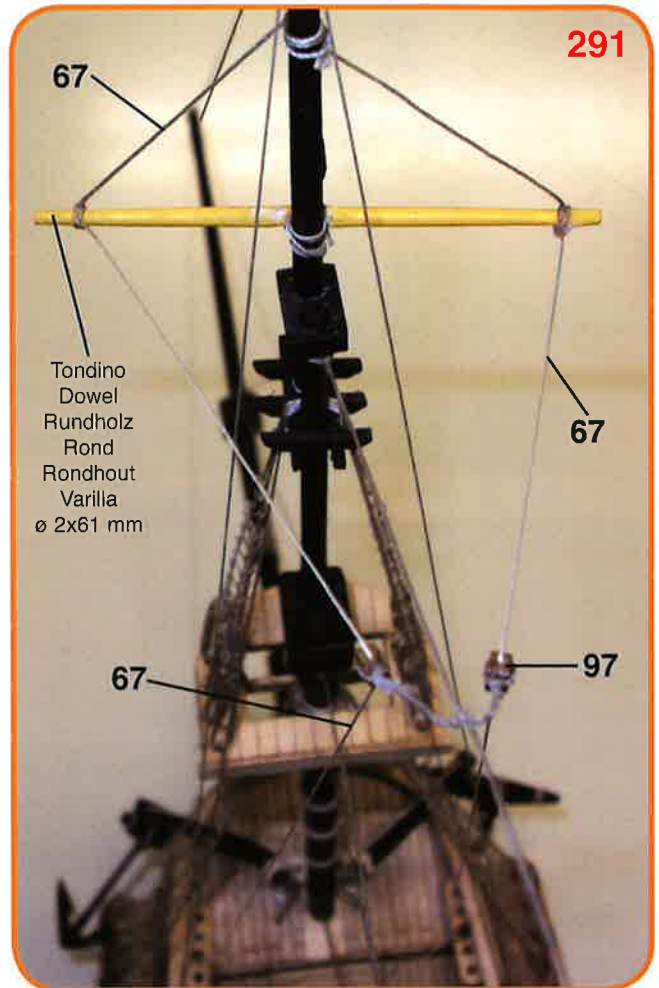
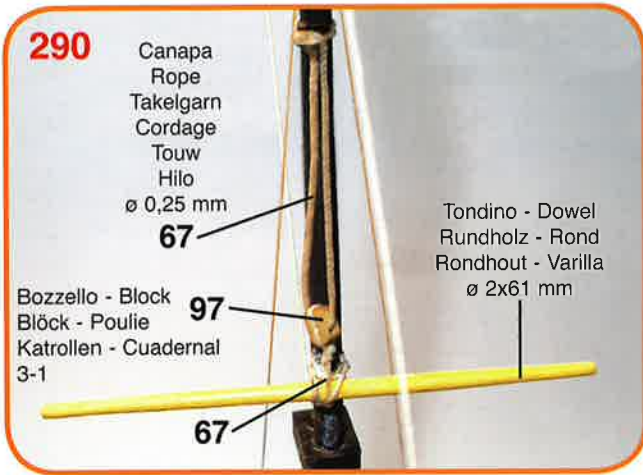

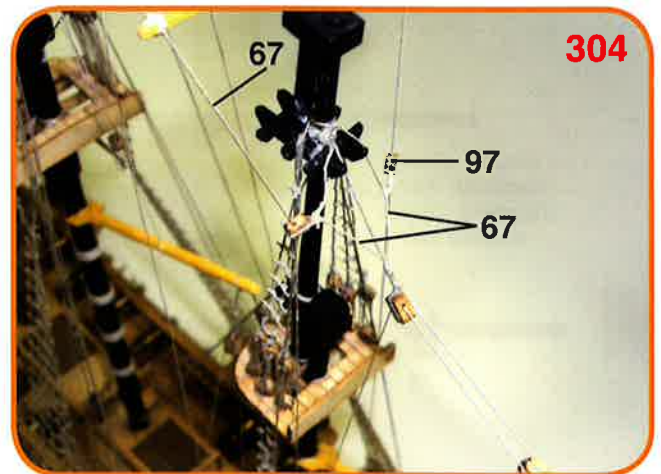
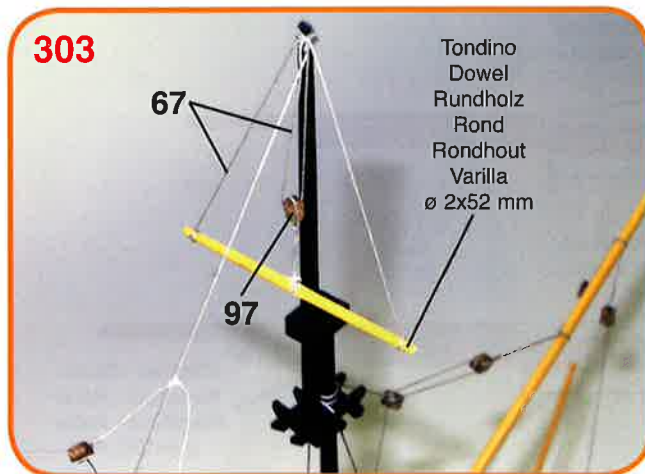
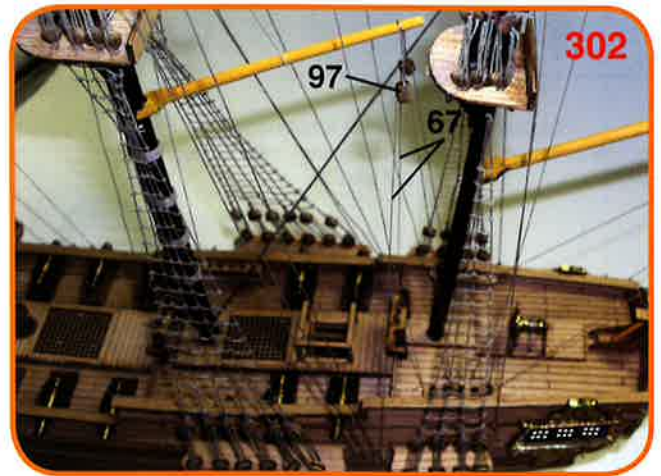
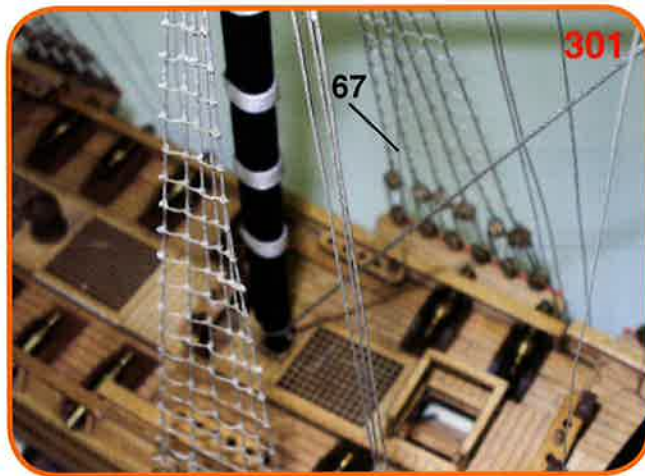
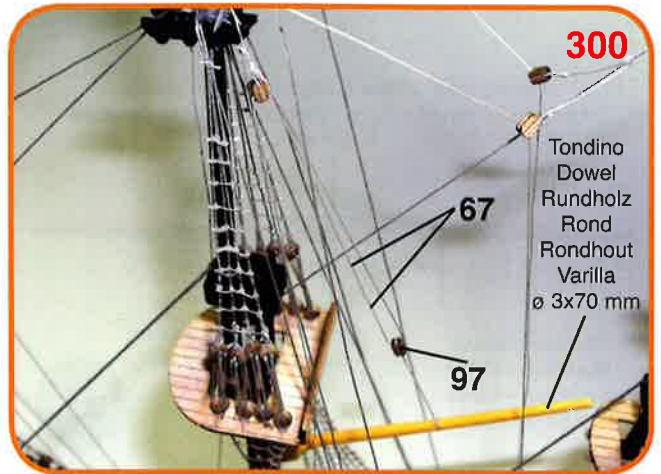
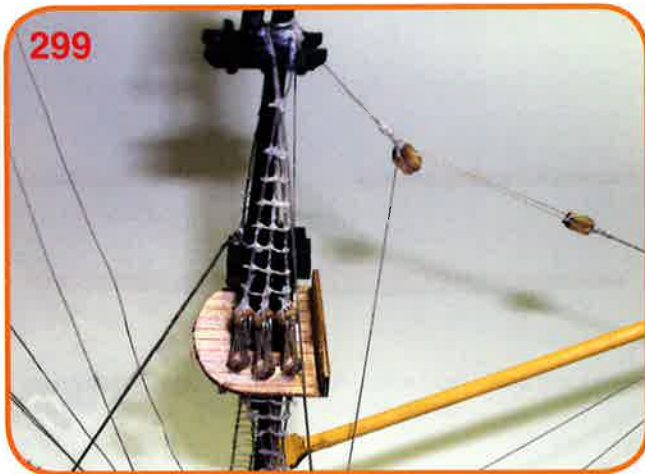
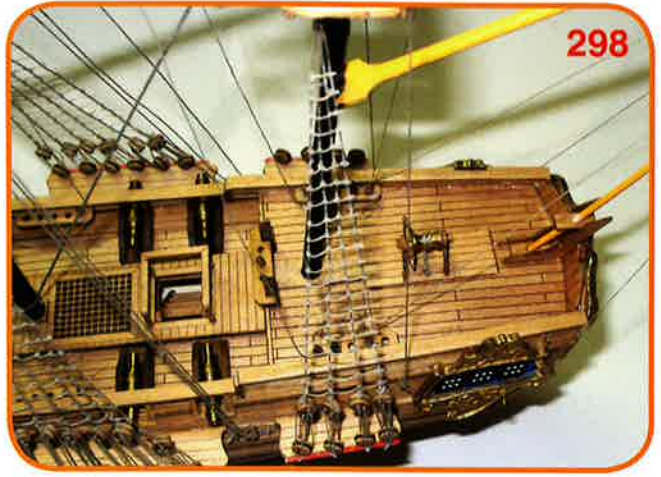
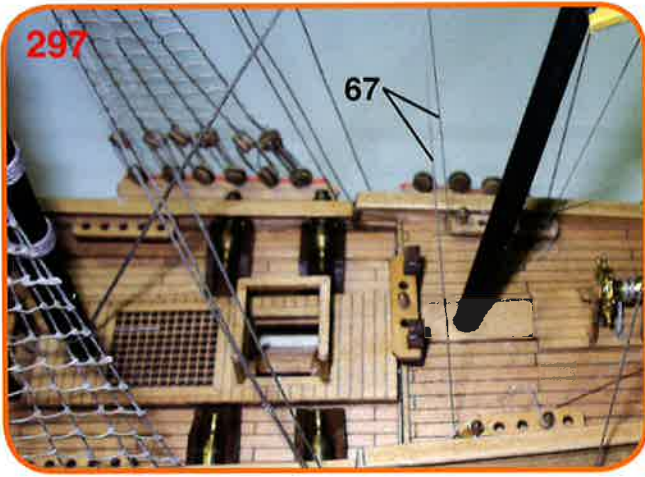

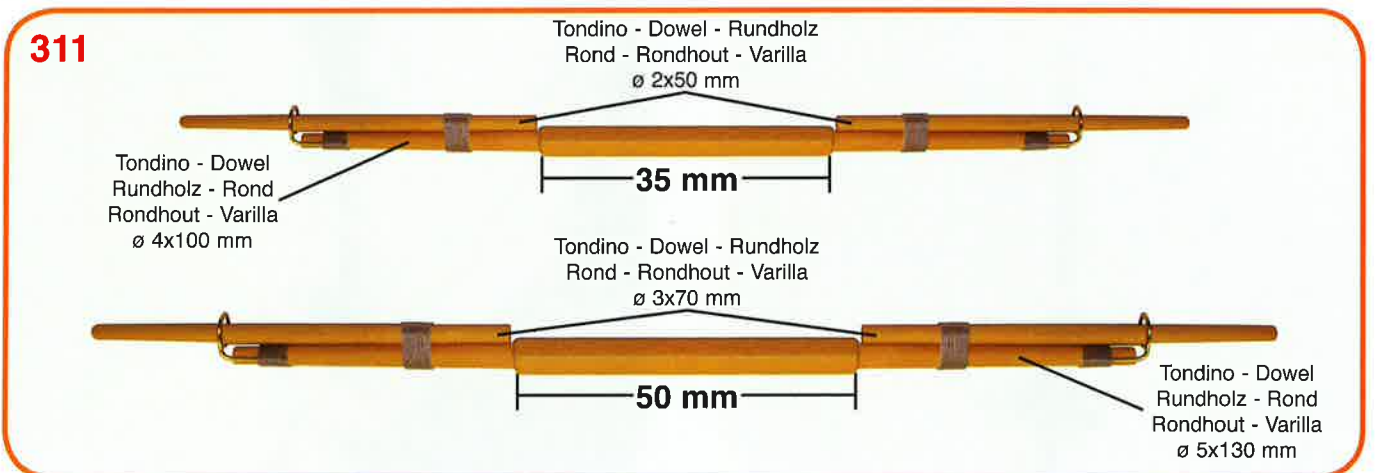
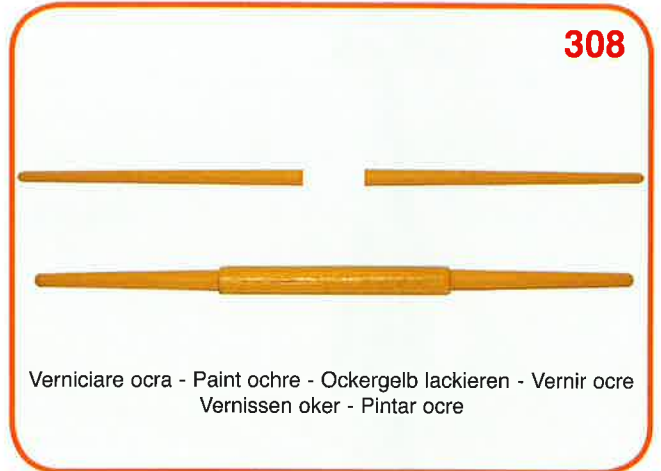
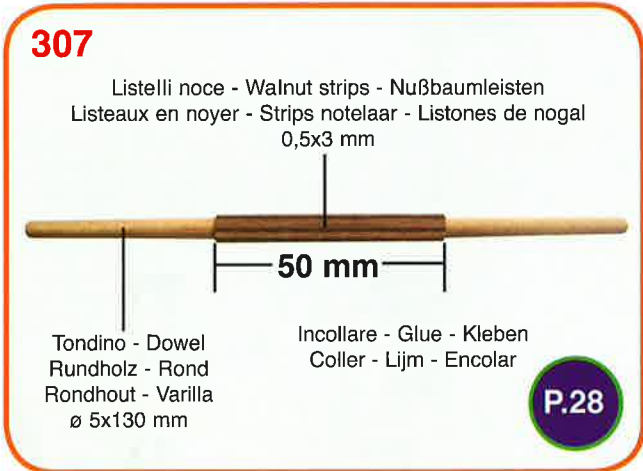
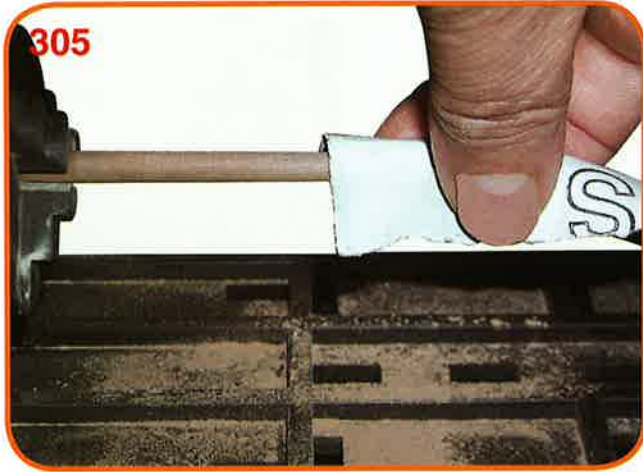

312

Tondino - Dowel - Rundholz
Rond - Rondhout - Varilla
ø 2x60 mm

Tondino - Dowel
Rundholz - Rond
Rondhout - Varilla
ø 4x103 mm

30 mm

Tondino - Dowel - Rundholz
Rond - Rondhout - Varilla
ø 3x82 mm

45 mm

Tondino - Dowel
Rundholz - Rond
Rondhout - Varilla
ø 5x148 mm

313

Tondino - Dowel - Rundholz - Rond - Rondhout - Varilla
ø 4x110 mm

P.28

Listelli noce - Walnut strips
Nußbaumleisten - Listeaux en noyer
Strips notelaar - Listones de nogal
0,5x3 mm

35 mm

Incollare - Glue - Kleben - Coller - Lijm - Encolar

314

Tondino - Dowel - Rundholz
Rond - Rondhout - Varilla
ø 4x110 mm

Verniciare ocre - Paint ochre - Ockergelb lackieren - Vernir ocre
Vernissen oker - Pintar ocre

315

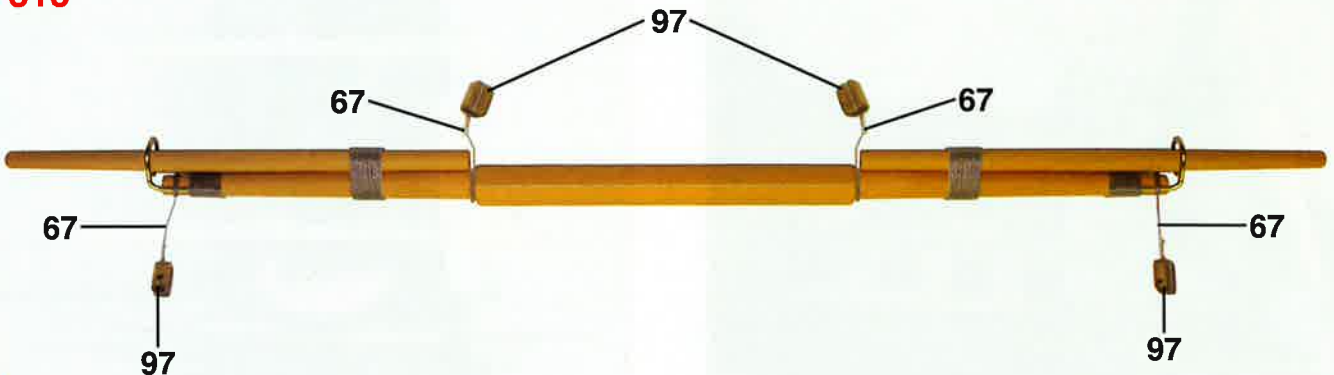

316

67
97

P.30

317

P.30

67
97

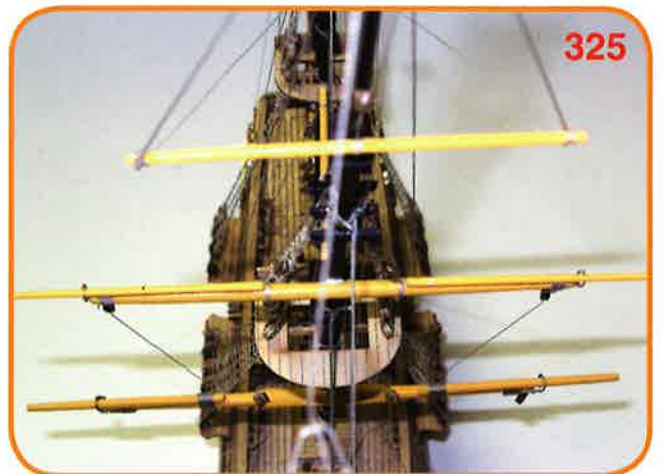
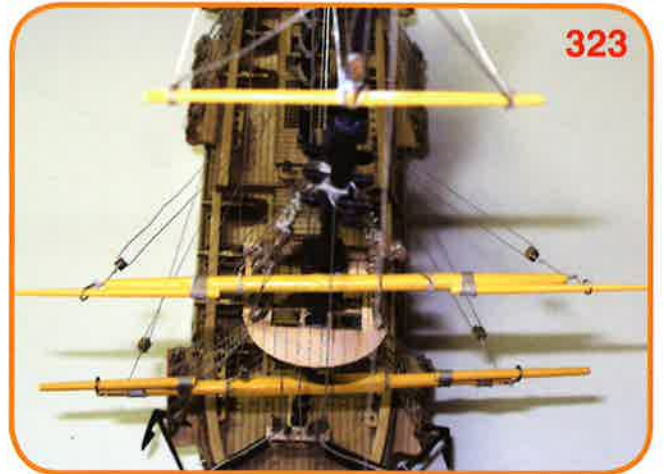
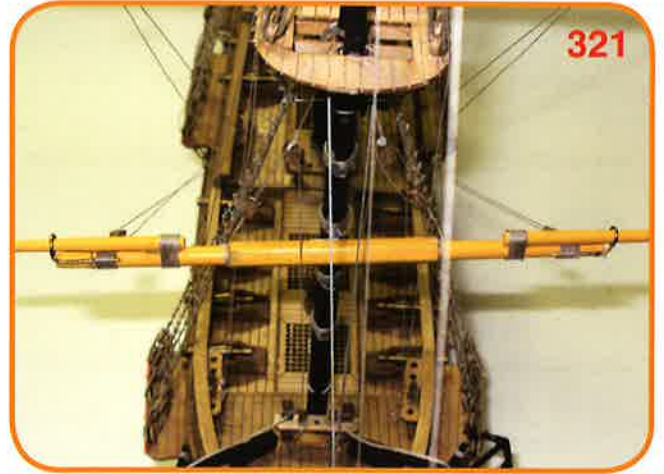
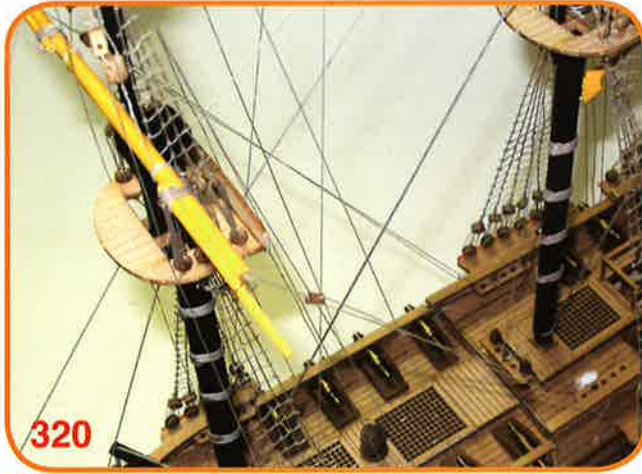
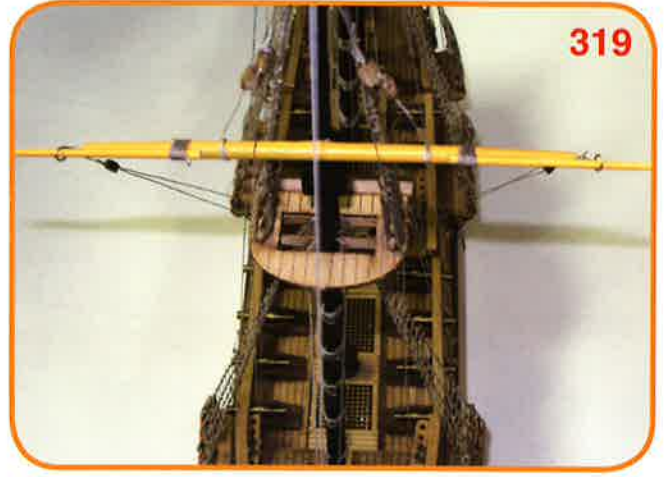

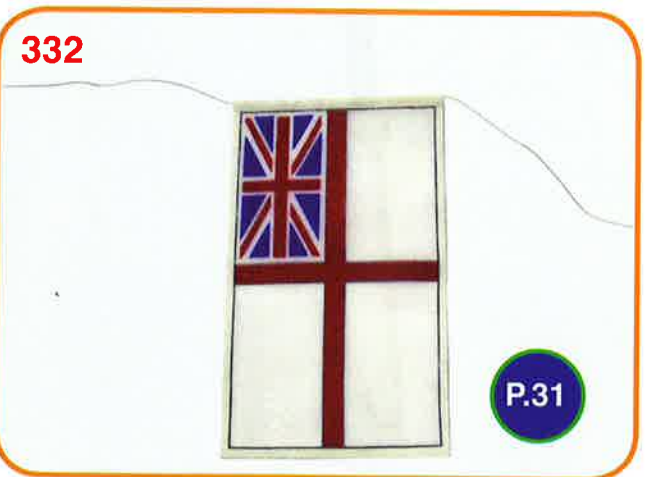
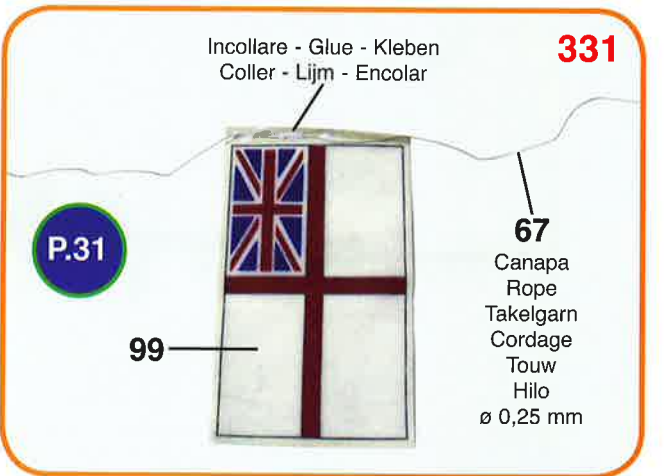
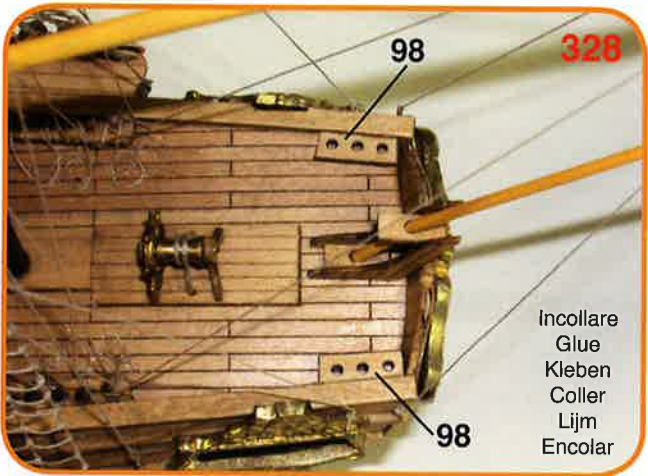
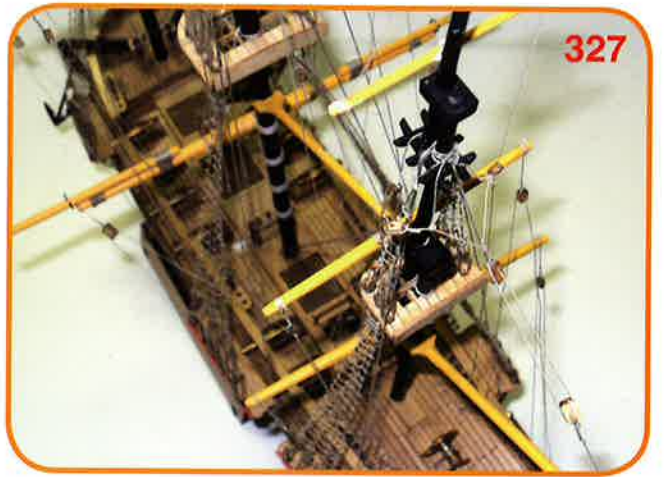
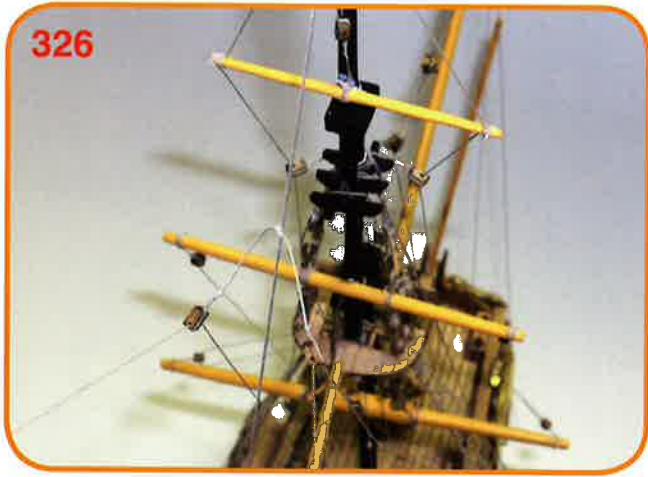



LISTA DEI MATERIALI Descrizione	MATERIAL LIST Description	MATERIALLISTE Beschreibung	LISTE DI MATÉRIEL Description	MATERIALENLIJST Beschrijving	LISTA DE MATERIALES Descripción	mm. Aan.	Quan. Anz. Ident N. Nr.	Disegno N.
Tavola compensato	Plywood board	Sperrholzplatte	Planche contreplaqué	Plaat triplex	Tabla chapa	5x200x500	1	1-2-3-3A-4-5-5A-6-7-7A-8-9-10-11-12-13-14-15-38-63
Tavola compensato	Plywood board	Sperrholzplatte	Planche contreplaqué	Plaat triplex	Tabla chapa	5x200x140	1	68-69-70
Tavola compensato	Plywood board	Sperrholzplatte	Planche contreplaqué	Plaat triplex	Tabla chapa	3x27x100	1	71-85-85A-88-90-90A
Tavola laser-incisa	Laser engraved sheet	Laser eingeschnitten	Planche laser-gravée	Laser ingesneden plank	Tabla laser grabó	1,2x152x404	1	16-16A-16B-17-18-18A-19-21-22-23-24-25-26-36-36A-41-42-43-47-51
Tavola laser-incisa	Laser engraved sheet	Laser eingeschnitten	Planche laser-gravée	Laser ingesneden plank	Tabla laser grabó	1,2x85x404	1	20-30-34-45-46-52-53-54-56-73-74-75-76-77-78-79-80-81-82-83-84-86-87-89-91-92-93-98
Tavola laser-incisa	Laser engraved sheet	Laser eingeschnitten	Planche laser-gravée	Laser ingesneden plank	Tabla laser grabó	0,8x35x55	1	33
Listelliiglio	Lime wood strips	Lindenholzleisten	Listeaux en tilleul	Strips in lindehout	Listones de cal	1,5x6x350	45	-
Listelli noce	Walnut strips	Nußbaumleisten	Listeaux en noyer	Strips notelaar	Listones de nogal	1x3x350	30	-
Listelli noce	Walnut strips	Nußbaumleisten	Listeaux en noyer	Strips notelaar	Listones de nogal	0,5x3x350	12	-
Listello noce	Walnut strip	Nußbaumleiste	Listeau en noyer	Strip notelaar	Listone de nogal	2x5x100	1	-
Listelli noce	Walnut strips	Nußbaumleisten	Listeaux en noyer	Strips notelaar	Listones de nogal	2x3x350	4	-
Listelli noce	Walnut strips	Nußbaumleisten	Listeaux en noyer	Strips notelaar	Listones de nogal	1x2x350	6	-
Listelli noce	Walnut strips	Nußbaumleisten	Listeaux en noyer	Strips notelaar	Listones de nogal	2x2x420	2	-
Listelli noce	Walnut strips	Nußbaumleisten	Listeaux en noyer	Strips notelaar	Listones de nogal	4x4x50	1	-
Listello noce	Walnut strip	Nußbaumleiste	Listeau en noyer	Strip notelaar	Listone de nogal	3x3x150	1	-
Listello noce	Walnut strip	Nußbaumleiste	Listeau en noyer	Strip notelaar	Listone de nogal	1x1x300	1	-
Tondini noce	Walnut dowels	Nußbaum-Rundstäben	Ronds en noyer	Rondhout in notelaar	Varilla de nogal	ø 2x330	2	-
Tondini noce	Walnut dowels	Nußbaum-Rundstäben	Ronds en noyer	Rondhout in notelaar	Varilla de nogal	ø 3x400	2	-
Tondini noce	Walnut dowels	Nußbaum-Rundstäben	Ronds en noyer	Rondhout in notelaar	Varilla de nogal	ø 4x500	2	-
Tondini noce	Walnut dowels	Nußbaum-Rundstäben	Ronds en noyer	Rondhout in notelaar	Varilla de nogal	ø 5x330	2	-
Tondino noce	Walnut dowel	Nußbaum-Rundstaben	Rond en noyer	Rondhout in notelaar	Varilla de nogal	ø 6x400	1	-
Filo ottone	Brass wire	Messingdraht	Fil de laiton	Draad van messing	Hilo de latón	ø 0,8x700	1	-
Affusti cannone	Gun bodies	Geschützlafetten	Affûts de canons	Onderstellen	Carro de cañones	-	12	27
Caronade	Carronades	Kleine Schiffskanonen	Caronades	Kanonnen	Cañones	24 mm	12	28
Polena	Figure head	Galionsfigur	Figure de poupe	Boegbeeld	Mascarón de proa	-	1	29
Ornamenti di poppa	Stern decoration	Heckdekoration	Ornement de poupe	Versiering van achtersterven	Ornamento de popa	-	-	31-32
Argano	Capstan	Gangspill	Cabestan	Kaapstaander	Árgana	ø 8x12	1	35
Montanti scala DX	Right ladder sides	Treppenholme rechts	Echelles droites	Rechter ladder zijden	Lateral derecho escalera	2x3x60	1	37
Montanti scala SX	Left ladder sides	Treppenholme links	Echelles gauches	Linker ladder zijden	Lateral izquierdo escalera	2x3x60	1	37

LISTA DEI MATERIALI Descrizione	MATERIAL LIST Description	MATERIALLISTE Beschreibung	LISTE DI MATÉRIEL Description	MATERIALENLIJST Beschrijving	LISTA DE MATERIALES Descripción	mm.	Quan. Anz. Aan.	Disegno N. Ident N. Nr.
Ancore	Anchors	Anker	Ancre	Ankers	Anclas	-	2	39
Anelli ottone	Brass rings	Messingringe	Anneaux en laiton	Messing ringen	Anillos de latón	ø 5	2	39A
Canapa	Rope	Takelgarn	Cordage	Touw	Cáñamo	ø 0,25	30 mt	67
Canapa	Rope	Takelgarn	Cordage	Touw	Cáñamo	ø 0,50	20 mt	40
Canapa	Rope	Takelgarn	Cordage	Touw	Cáñamo	ø 1	2 mt	62
Modanatura	Mouldings	Gemodait einfassung	Mou lure	Molures	Moldura	1,5x2,5x500	1	44
Ruota timone	Rudder wheel	Steuerrad	Roue	Roerwiel	Rueda del timón	15	1	48
Tamburo	Drum	Welleruderrad	Tambour	Trommel	Tambor	ø 5x8	1	49
Perni ottone	Brass pins	Messingstift	Tourillons en laiton	Koperen pinnen	Eje de latón	ø 0,8x20	1	50
Perni ottone	Brass pins	Messingstift	Tourillons en laiton	Koperen pinnen	Eje de latón	ø 2x12	4	55
Lande ottone	Plate	Kettenglieder	Attaches	Spanners	Estribo de cadenote	ø 5	30	57
Bigotte noce	Walnut dead-eyes	Jungfern, Nußbaum	Caps de mouton en noyer	Wainoten slagblokken	Vigota	ø 5	60	58
Bigotte noce	Walnut dead-eyes	Jungfern, Nußbaum	Caps de mouton en noyer	Wainoten slagblokken	Vigota	ø 3	44	96
Staffe lande	Clamps	Bügel der Rüsteisen	Lattes des haubans	Klemmen	Estribo de cadenote	8	30	59
Anelli ovali	Oval rings	Kettenglied	Anneaux ovales	Ovalen ringen	Anilla óvalos	8	60	60
Chiodini ottone	Brass nails	Drahstifte, Messing	Clous en laiton	Nagels	Clavo de latón	-	100	61
Cerniere timone	Rudder hinges	Ruderscharniere	Charnière de gouvernail	Roerscharnieren	Bisagras de timón	-	6	64
Perni cerniere	Hinge pin	Wellen für Ruderscharniere	Axes de charnières	Scharnieren pinnen	Pernos de bisagras	-	3	65
Anelli ottone	Brass rings	Messingringe	Anneaux en laiton	Messing ringen	Anillos de latón	ø 3	4	66
Battute	Pintles	Fingerling	Pitons	Pintles	Perno	-	36	72
Bozzelli noce - 1 foro	Walnut blocks - 1 eye	Nußbaum blöcke, einfach	Poulies simple en noyer	Wainoten katrollen - 1 ogig	Motones 1 orificio	3/1	32	97
Bozzelli noce - 1 foro	Walnut blocks - 1 eye	Nußbaum blöcke, einfach	Poulies simple en noyer	Wainoten katrollen - 1 ogig	Motones 1 orificio	5/1	22	94
Caviglie noce	Walnut belaying-pin	Koffienägel, Nußbaum	Cabillots en noyer	Wainoten belegpinnen	Cabillas de nogal	8	34	95
Bandiera	Flag	Flagge	Drapeau	Vlagge	Bandera	-	1	99
Tavole disegno	Construction plans	Baupläne	Planches de construction	Bouwplannen	Hojas de planos	-	2	-
Libretto istruzioni	Booklet with instruct.	Anleitungen	Livret pour les instructions	Handleiding	Libro de instrucciones	-	1	-